

Pin Descriptions

Pin Name	P/I/O	Pin #	Description
Out 2 (Note 1)	O	1	Output Pin (active Low)
GND	P/I	2	Ground
NC		3	No Connection
Vdd	P/I	4	Power Supply Voltage
Out 1 (Note 1)	O	5	Output Pin (active Low)

Notes: 1. Output1 responds to South pole; Output2 responds to North pole.

Functional Block Diagram

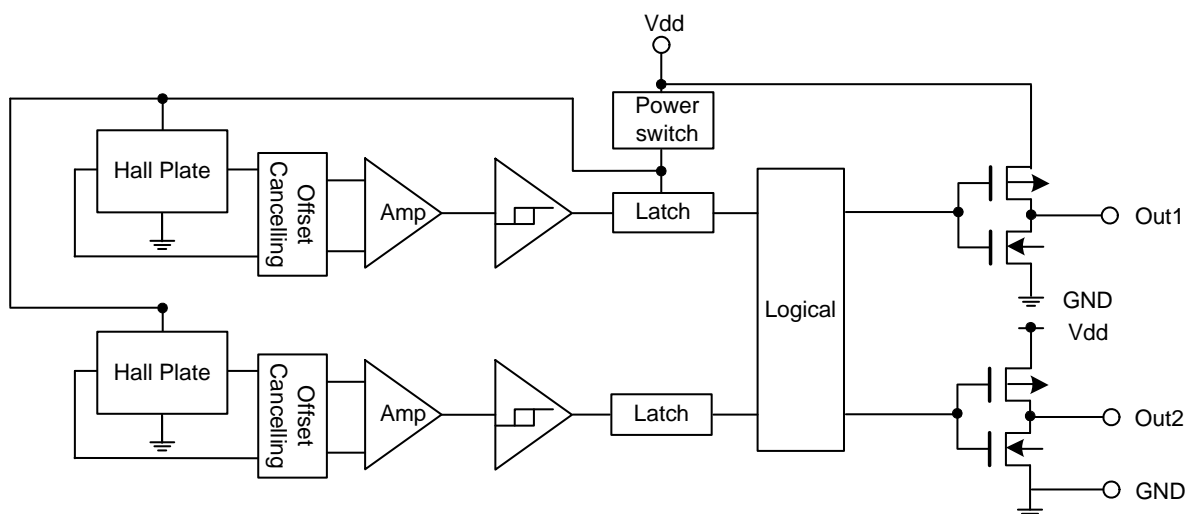

Absolute Maximum Ratings (T_A = 25°C)

Symbol	Characteristics	Values	Unit
V _{dd}	Supply voltage	5	V
B	Magnetic flux density	Unlimited	
T _S	Storage Temperature Range	-65 to +150	°C
P _D	Package Power Dissipation	230	mW
T _J	Maximum Junction Temperature	150	°C

Recommended Operating Conditions (T_A = 25°C)

Symbol	Parameter	Conditions	Rating	Unit
V _{dd}	Supply Voltage	Operating	1.65 to 3.3	V
T _A	Operating Temperature Range	Operating	-40 to +85	°C

Electrical Characteristics ($T_A = 25^\circ\text{C}$, $V_{dd} = 1.8\text{V}$, unless otherwise specified)

Symbol	Characteristic	Conditions	Min	Typ.	Max	Unit
V_{OH}	Output On Voltage (High side)	$I_O = -0.5\text{mA}$	$V_{dd}-0.2$	-	-	V
V_{OL}	Output On Voltage (Low side)	$I_O = 0.5\text{mA}$	-	-	0.2	V
$I_{dd(en)}$	Supply Current	Chip enable	-	2	4	mA
$I_{dd(dis)}$		Chip disable	-	5	8	μA
$I_{dd(avg)}$		average supply current	-	7	12	μA
Tawake	Awake Time		-	50	100	μs
Tperiod	Period		-	50	100	ms
D.C.	Duty Cycle		-	0.1	-	%

Magnetic Characteristics ($T_A = 25^\circ\text{C}$, $V_{dd} = 1.8\text{V}\sim 3.0\text{V}$, Note 2, 3, 4)

(1mT=10 Gauss)

Symbol	Characteristic	Min	Typ.	Max	Unit
Bops(south pole to brand side)	Operate Point	-	35	50	Gauss
Bopn(north pole to brand side)		-50	-35	-	
Brps(south pole to brand side)	Release Point	6	20	-	
Brpn(north pole to brand side)		-	-20	-6	
$B_{hy}(B_{opx} - B_{rpx})$	Hysteresis	3	15	-	

- Notes:
- Typical data is at $T_A = 25^\circ\text{C}$, $V_{dd} = 3\text{V}$, and for design information only.
 - Bops & Brps for Output 1 responds to South pole; Bopn & Brpn for Output 2 responds to North pole.
 - The magnetic characteristics may vary with supply voltage, operating temperature and after soldering.

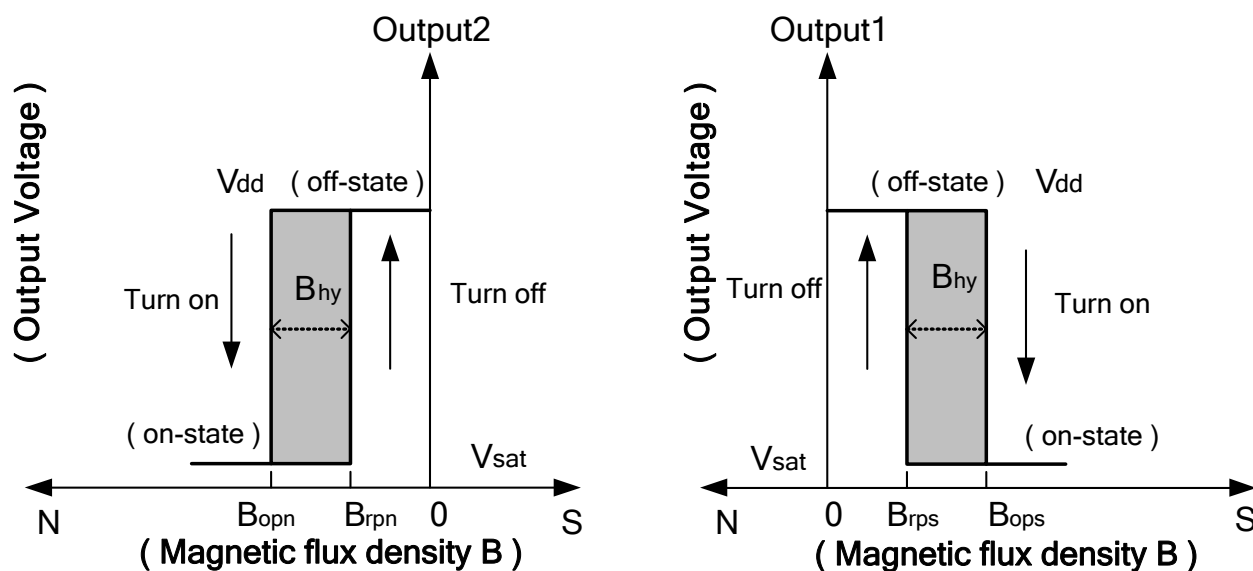

Typical Operating Characteristics

Switching Point

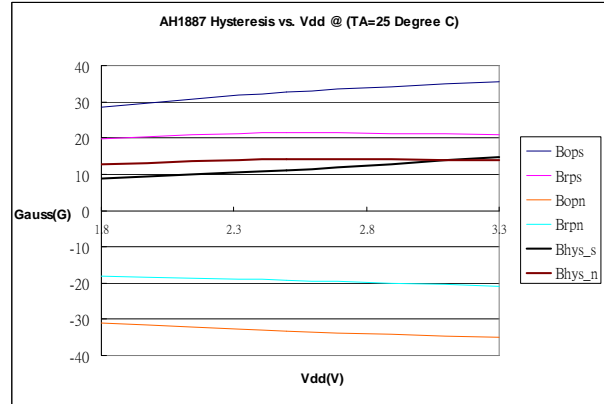
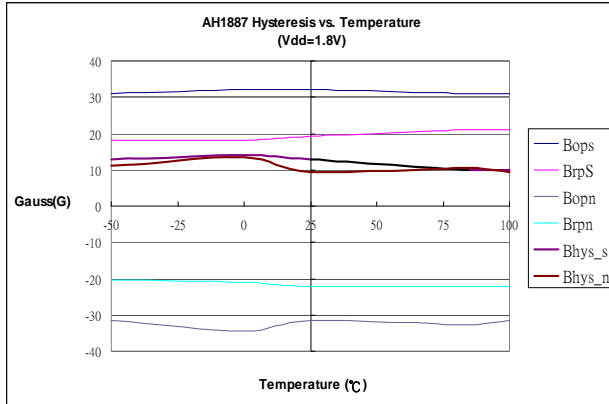

Supply Current

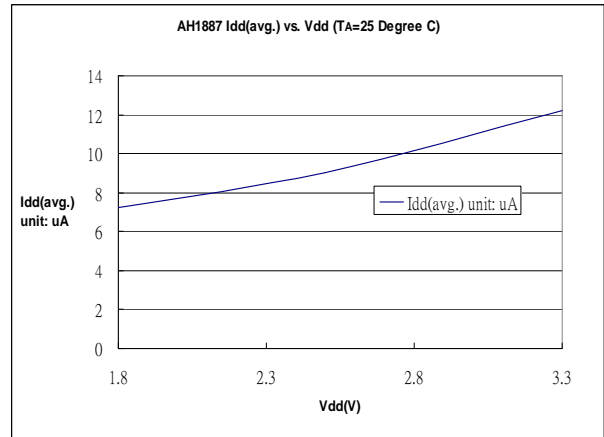
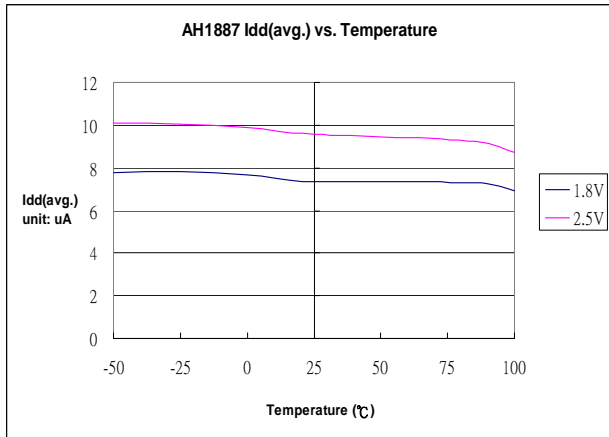

Performance Characteristics

T _A (°C)	25	50	60	70	80	85	90	100	110	120	130	140	150
P _D (mW)	230	184	166	147	129	120	110	92	74	55	37	18	0

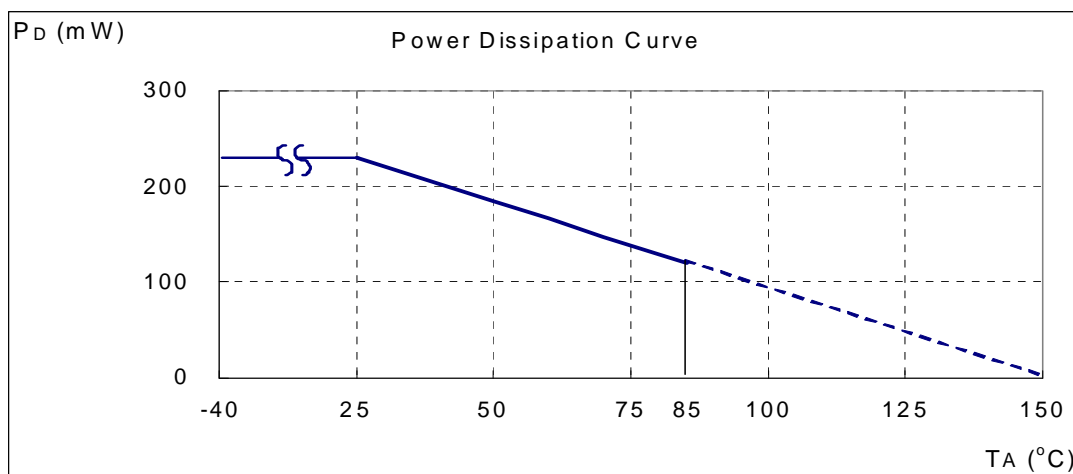

Ordering Information

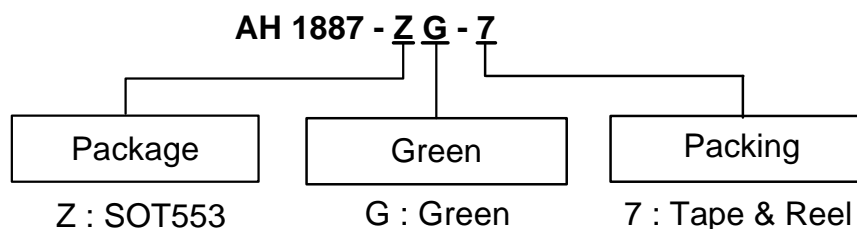

Device	Package Code	Packaging (Note 5 & 6)	7" Tape and Reel	
			Quantity	Part Number Suffix
AH1887-ZG-7	Z	SOT553	3000/Tape & Reel	-7



- Notes:
5. EU Directive 2002/95/EC (RoHS). All applicable RoHS exemptions applied. Please visit our website at http://www.diodes.com/products/lead_free.html.
 6. Pad layout as shown on Diodes Inc. suggested pad layout document AP02001, which can be found on our website at <http://www.diodes.com/datasheets/ap02001.pdf>.

Marking Information

(1) SOT553

(Top View)

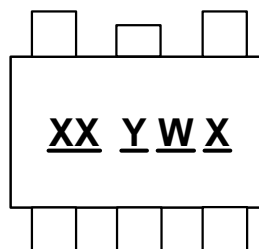

XX : Identification Code
Y : Year : 0~9
W : Week : A~Z : 1~26 week;
 a~z : 27~52 week;
 z represents 52 and 53 week
X : A~Z : Green

Part Number	Package	Identification Code
AH1887	SOT553	KU

Package Outline Dimensions (All Dimensions in mm)

(1) Package Type: SOT553

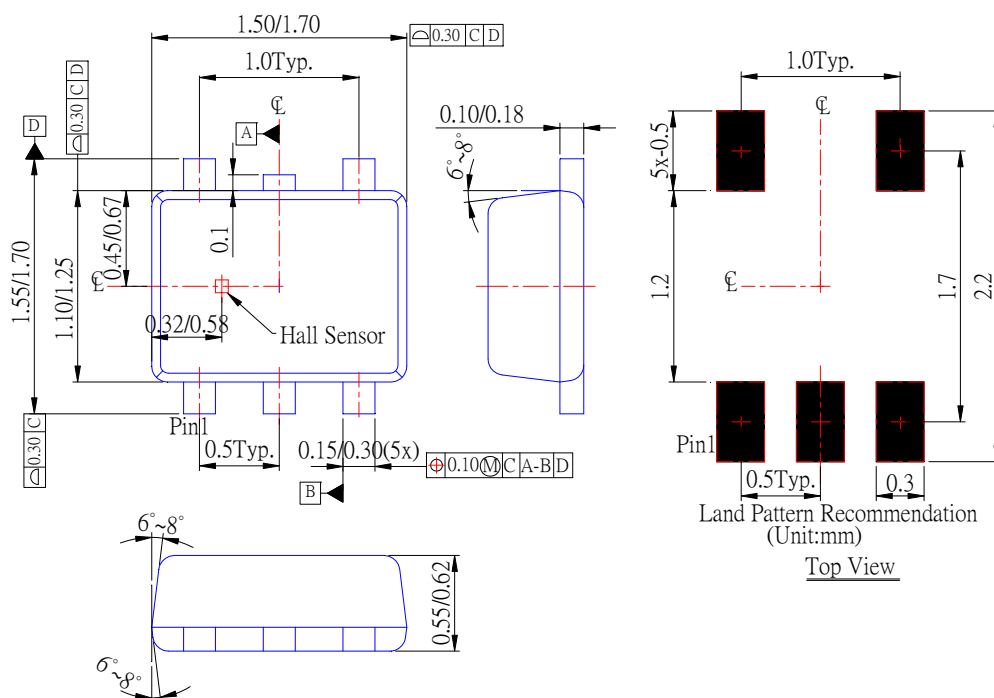

IMPORTANT NOTICE

DIODES INCORPORATED MAKES NO WARRANTY OF ANY KIND, EXPRESS OR IMPLIED, WITH REGARDS TO THIS DOCUMENT, INCLUDING, BUT NOT LIMITED TO, THE IMPLIED WARRANTIES OF MERCHANTABILITY AND FITNESS FOR A PARTICULAR PURPOSE (AND THEIR EQUIVALENTS UNDER THE LAWS OF ANY JURISDICTION).

Diodes Incorporated and its subsidiaries reserve the right to make modifications, enhancements, improvements, corrections or other changes without further notice to this document and any product described herein. Diodes Incorporated does not assume any liability arising out of the application or use of this document or any product described herein; neither does Diodes Incorporated convey any license under its patent or trademark rights, nor the rights of others. Any Customer or user of this document or products described herein in such applications shall assume all risks of such use and will agree to hold Diodes Incorporated and all the companies whose products are represented on Diodes Incorporated website, harmless against all damages.

Diodes Incorporated does not warrant or accept any liability whatsoever in respect of any products purchased through unauthorized sales channel.

Should Customers purchase or use Diodes Incorporated products for any unintended or unauthorized application, Customers shall indemnify and hold Diodes Incorporated and its representatives harmless against all claims, damages, expenses, and attorney fees arising out of, directly or indirectly, any claim of personal injury or death associated with such unintended or unauthorized application.

Products described herein may be covered by one or more United States, international or foreign patents pending. Product names and markings noted herein may also be covered by one or more United States, international or foreign trademarks.

LIFE SUPPORT

Diodes Incorporated products are specifically not authorized for use as critical components in life support devices or systems without the express written approval of the Chief Executive Officer of Diodes Incorporated. As used herein:

- A. Life support devices or systems are devices or systems which:
1. are intended to implant into the body, or
 2. support or sustain life and whose failure to perform when properly used in accordance with instructions for use provided in the labeling can be reasonably expected to result in significant injury to the user.
- B. A critical component is any component in a life support device or system whose failure to perform can be reasonably expected to cause the failure of the life support device or to affect its safety or effectiveness.

Customers represent that they have all necessary expertise in the safety and regulatory ramifications of their life support devices or systems, and acknowledge and agree that they are solely responsible for all legal, regulatory and safety-related requirements concerning their products and any use of Diodes Incorporated products in such safety-critical, life support devices or systems, notwithstanding any devices- or systems-related information or support that may be provided by Diodes Incorporated. Further, Customers must fully indemnify Diodes Incorporated and its representatives against any damages arising out of the use of Diodes Incorporated products in such safety-critical, life support devices or systems.

Copyright © 2010, Diodes Incorporated

www.diodes.com