

Typical Application Circuit (Note 4)

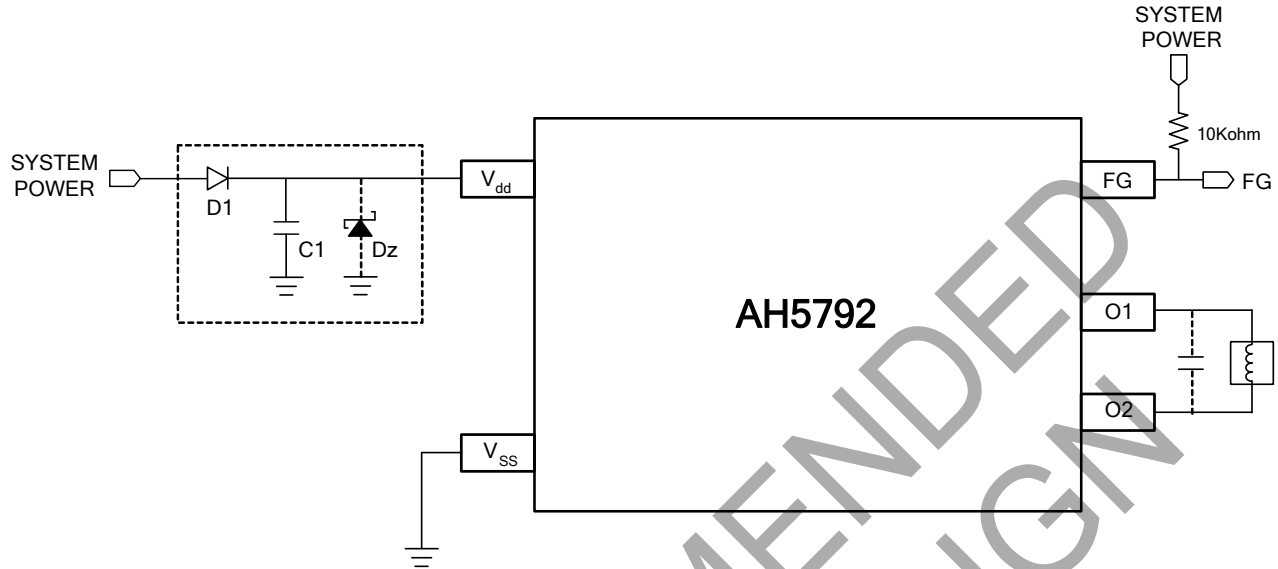

Note: 4. Reverse connection of power supply may break the device. A countermeasure is needed such as using reverse power protection diode D1 between power supply and V_{dd} terminal. In such case of using reverse power protection diode D1 because of there is no way to return current to power supply, please take necessary measures like below.

- Connect Dz (Zener diode) between V_{dd} and V_{ss} terminal, not to exceed the absolute maximum rating voltage.
- Connect a capacitor C1 between V_{dd} and V_{ss} terminal, to make the path of return current to power supply.

The AH5792 has an open-drain tachometer FG output that follows the half (1/2) the magnetic change frequency. A pull-up resistor (10kΩ, typically for System Power = 5V) connected to a supply voltage.

Pin Descriptions (Note 5)

Pin Name	Description
O1	Output Driving & Sinking Pin 1
Vdd	Power Supply Pin
Vss	Ground Pin
FG	Frequency Generator (Note 5)
O2	Output Driving & Sinking Pin 2
NC	No Connection

Note: 5. The FG is half (1/2) the magnetic change frequency.

Functional Block Diagram

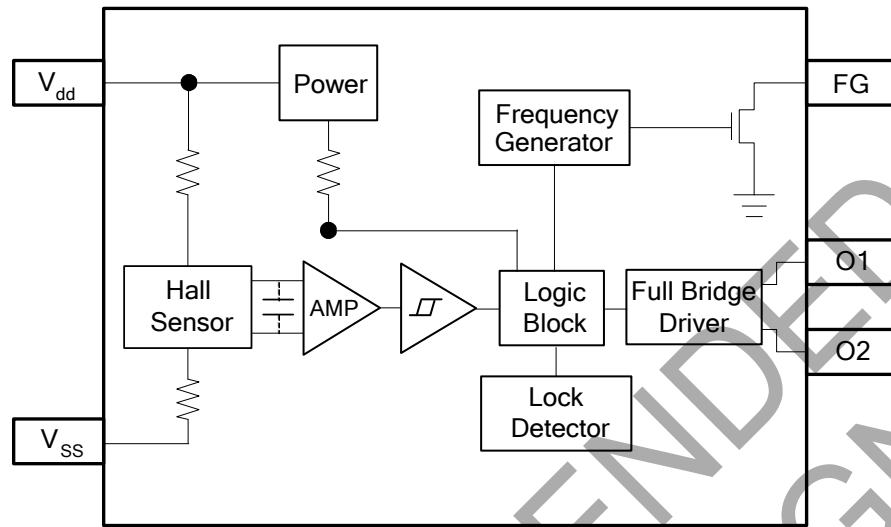

Operating (Notes 6, 7, 8)

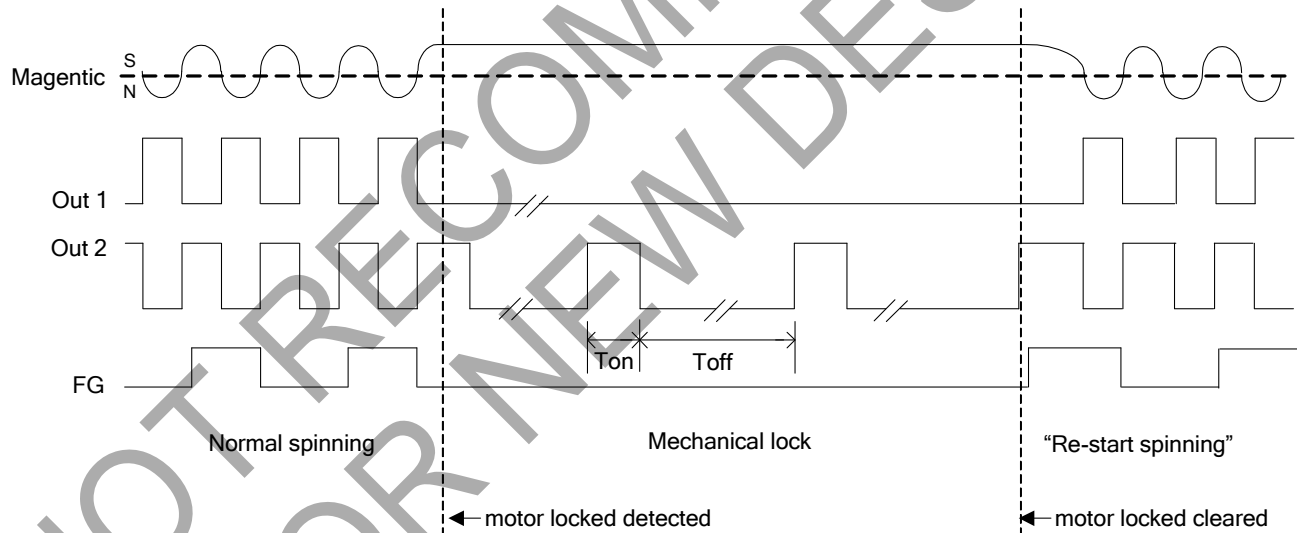

- Notes:
6. In "Normal spinning", the FG shall change its state at each rising edge of OUT2. In "Mechanical lock", the FG state is kept as the same as the moment of motor locked detected.
 7. When magnetic is locked as "S" pole, then out1 is kept on "L", out2 is a clock with Ton/Toff ratio. When magnetic is locked at "N" pole, then out 2 is kept on "L", out 1 is a clock with Ton/Toff ratio.
 8. When "Re-start spinning" occurs, the motor shall ramp up to the "Normal Spinning" speed from zero. It depends on the motor characteristics.

Absolute Maximum Ratings (T_A = +25°C, unless otherwise noted.)

Symbol	Characteristics	Values	Unit
V _{DD}	Supply Voltage	6	V
I _{O(PEAK)}	Maximum Output Current (Peak)	SOT553	400 mA
		SOT89-5L	500 mA
P _D	Power Dissipation	SOT553	230 mW
		SOT89-5L	800 mW
T _{STG}	Storage Temperature Range	-65 to +150	°C

Recommended Operating Conditions (T_A = +25°C)

Symbol	Parameter	Conditions	Rating	Unit
V _{DD}	Supply Voltage	Operating	1.8 to 5.0	V
T _A	Operating Temperature Range	Operating	-40 to +100	°C

Electrical Characteristics (T_A = +25°C, V_{DD} = 5.0V)

Symbol	Characteristic	Conditions	Min	Typ.	Max	Unit
I _{DD}	Supply Current	No Load	—	3.5	5	mA
V _{OH}	Output Voltage High	I _{OUT} = 200mA (For SOT553)	4.4	—	—	V
		I _{OUT} = 300mA (For SOT89-5L)				
V _{OL}	Output Voltage Low	I _{OUT} = 200mA (For SOT553)	—	—	0.6	V
		I _{OUT} = 300mA (For SOT89-5L)				
I _{OUT}	Output Current	R _L = 30Ω	—	148	—	mA
I _{Leak}	FG Output Leakage Current	—	—	—	5	μA
I _{FG}	FG Output Current	V _{FGOL} = 0.4V	5	—	—	mA
V _{FGOL}	FG Output Voltage Low	I _{FG} = 5mA	—	—	0.4	V
T _{ON}	On Time	—	—	215	—	ms
R _{DR}	Duty Ratio	T _{OFF} / T _{ON}	—	10	—	—

Magnetic Characteristics ($T_A = +25^\circ\text{C}$, $V_{dd} = 1.8\text{V to } 5.0\text{V}$, Note 9)

(1mT = 10 G)

Symbol	Parameter	Min	Typ.	Max	Unit
B_{op}	Operate Point	10	30	50	G
B_{rp}	Release Point	-50	-30	-10	G
B_{hy}	Hysteresis	—	60	—	G

Note: 9. The magnetic characteristics may vary with supply voltage, operating temperature and after soldering.

Operating Characteristics

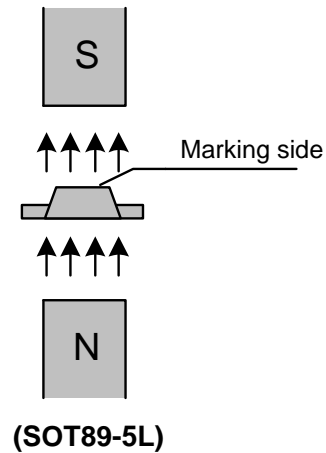
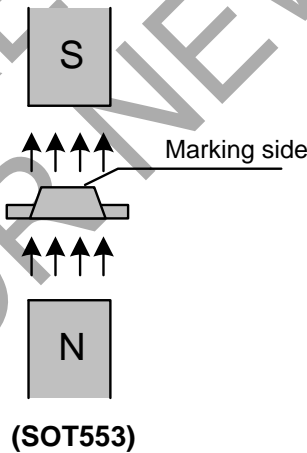
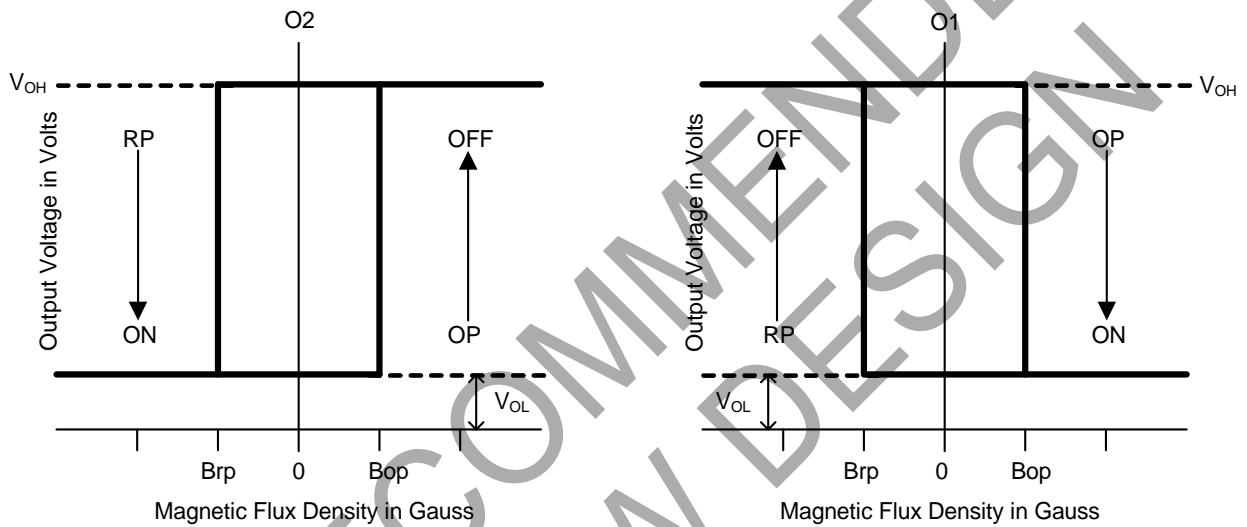

Performance Characteristics

(1) SOT553

T _A (°C)	25	50	60	70	80	85	90	100	110	120	130	140	150
P _D (mW)	230	184	166	147	129	120	110	92	74	55	37	18	0

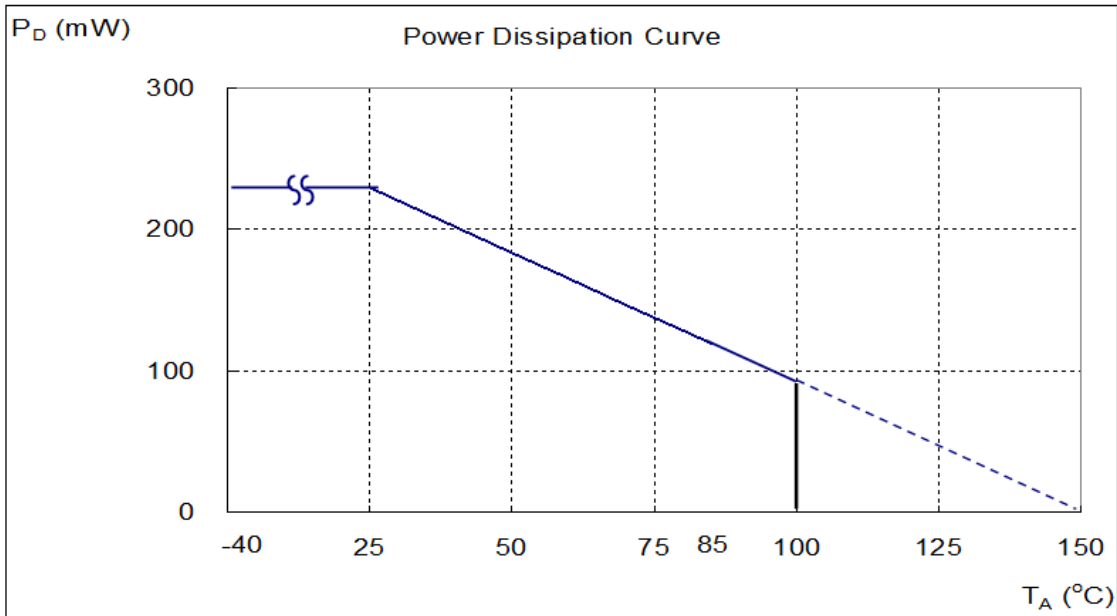

(2) SOT89-5L

T _A (°C)	25	50	60	70	75	80	85	90	95	100
P _D (mW)	800	640	576	512	480	448	416	384	352	320
T _A (°C)	105	110	115	120	125	130	135	140	145	150
P _D (mW)	288	256	224	192	160	128	96	64	32	0

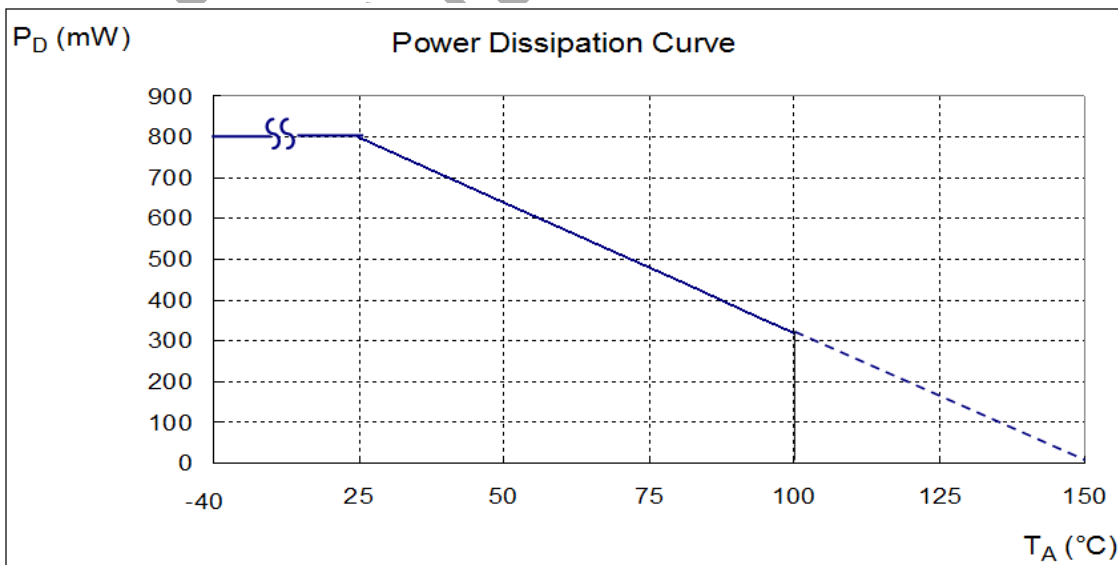

Ordering Information

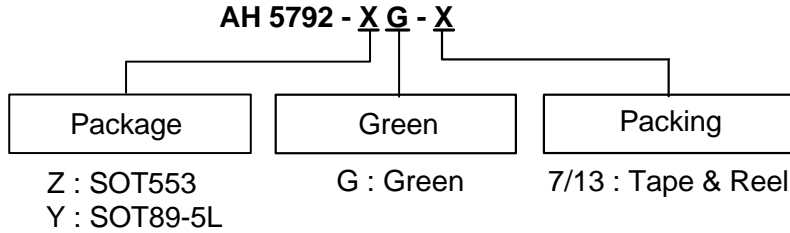

Device	Package Code	Packaging (Note 10)	7"/13" Tape and Reel	
			Quantity	Part Number Suffix
AH5792-ZG-7	Z	SOT553	3000/Tape & Reel	-7
AH5792-YG-13	Y	SOT89-5L	2500/Tape & Reel	-13

Note: 10. For packaging details, go to our website at <https://www.diodes.com/design/support/packaging/diodes-packaging/>.

Marking Information

(1) SOT553

(Top View)

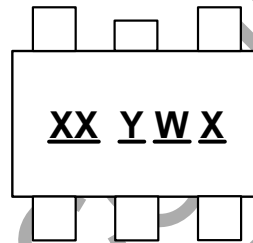

XX : Identification Code
Y : Year : 0~9
W : Week : A~Z : 1~26 week;
 a~z : 27~52 week;
 z represents 52 and 53 week
X : A~Z : Green

Part Number	Package	Identification Code
AH5792	SOT553	KE

(2) SOT89-5L

(Top View)

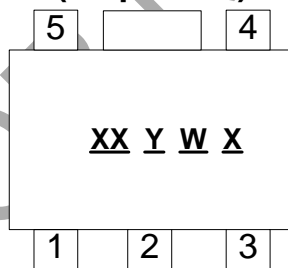

XX : Identification code
Y : Year : 0~9
W : Week : A~Z : 1~26 week;
 a~z : 27~52 week;
 z represents 52 and 53 week
X : Internal code
 A~Z : Green

Part Number	Package	Identification Code
AH5792	SOT89-5L	KF

Package Outline Dimensions (All Dimensions in mm)

Please see <http://www.diodes.com/package-outlines.html> for the latest version.

(1) Package Type: SOT553

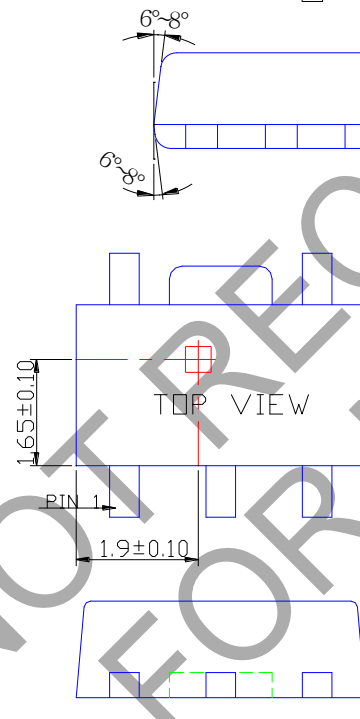
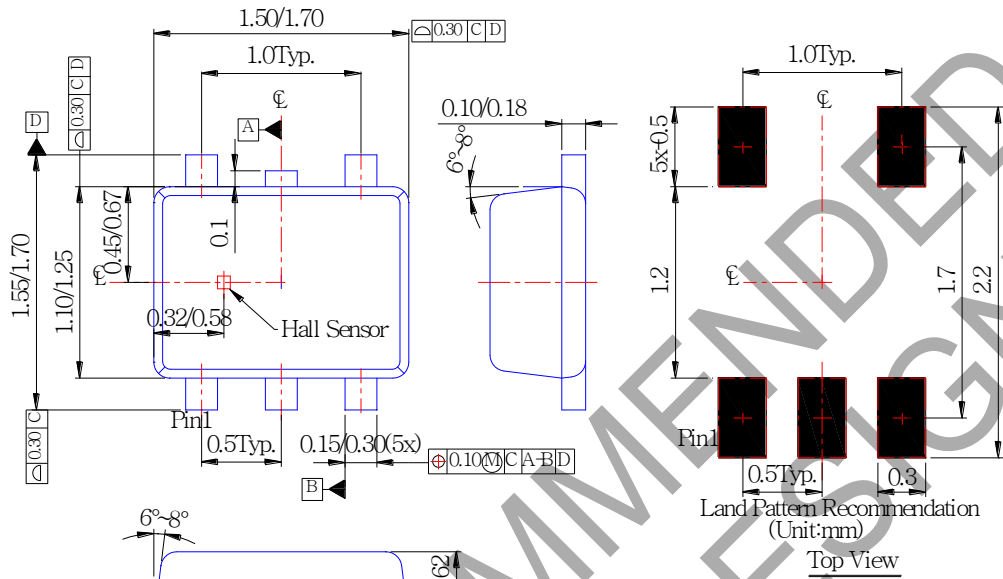

Sensor Location

Package Outline Dimensions (Continued)

Please see <http://www.diodes.com/package-outlines.html> for the latest version.

(2) Package Type: SOT89-5L

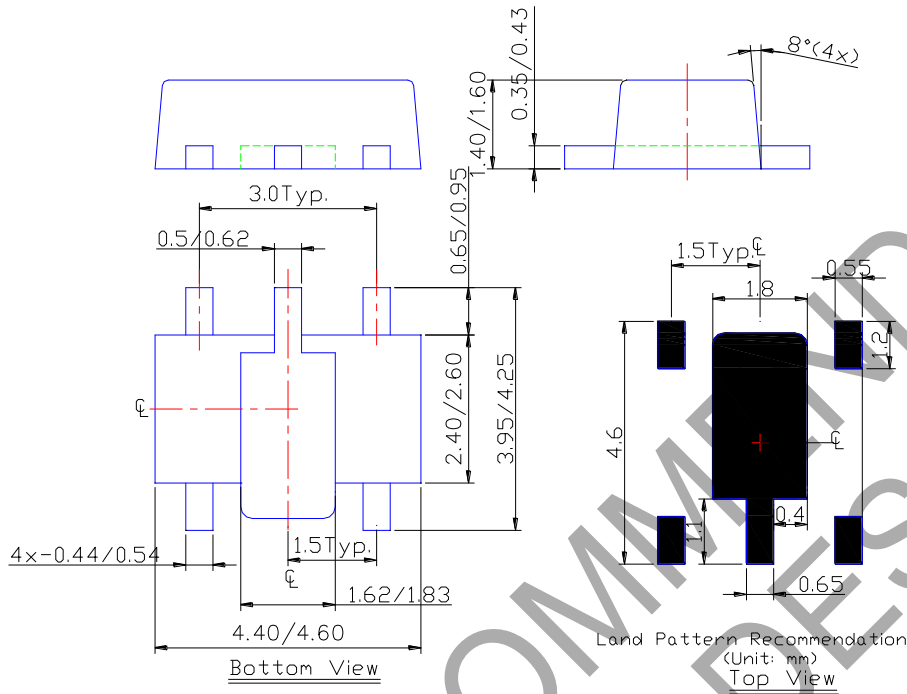

NOT FOR RECOMMENDED DESIGN

Sensor Location

Unit: mm

IMPORTANT NOTICE

1. DIODES INCORPORATED AND ITS SUBSIDIARIES (“DIODES”) MAKE NO WARRANTY OF ANY KIND, EXPRESS OR IMPLIED, WITH REGARDS TO ANY INFORMATION CONTAINED IN THIS DOCUMENT, INCLUDING, BUT NOT LIMITED TO, THE IMPLIED WARRANTIES OF MERCHANTABILITY, FITNESS FOR A PARTICULAR PURPOSE OR NON-INFRINGEMENT OF THIRD PARTY INTELLECTUAL PROPERTY RIGHTS (AND THEIR EQUIVALENTS UNDER THE LAWS OF ANY JURISDICTION).
2. The Information contained herein is for informational purpose only and is provided only to illustrate the operation of Diodes products described herein and application examples. Diodes does not assume any liability arising out of the application or use of this document or any product described herein. This document is intended for skilled and technically trained engineering customers and users who design with Diodes products. Diodes products may be used to facilitate safety-related applications; however, in all instances customers and users are responsible for (a) selecting the appropriate Diodes products for their applications, (b) evaluating the suitability of the Diodes products for their intended applications, (c) ensuring their applications, which incorporate Diodes products, comply the applicable legal and regulatory requirements as well as safety and functional-safety related standards, and (d) ensuring they design with appropriate safeguards (including testing, validation, quality control techniques, redundancy, malfunction prevention, and appropriate treatment for aging degradation) to minimize the risks associated with their applications.
3. Diodes assumes no liability for any application-related information, support, assistance or feedback that may be provided by Diodes from time to time. Any customer or user of this document or products described herein will assume all risks and liabilities associated with such use, and will hold Diodes and all companies whose products are represented herein or on Diodes’ websites, harmless against all damages and liabilities.
4. Products described herein may be covered by one or more United States, international or foreign patents and pending patent applications. Product names and markings noted herein may also be covered by one or more United States, international or foreign trademarks and trademark applications. Diodes does not convey any license under any of its intellectual property rights or the rights of any third parties (including third parties whose products and services may be described in this document or on Diodes’ website) under this document.
5. Diodes products are provided subject to Diodes’ Standard Terms and Conditions of Sale (<https://www.diodes.com/about/company/terms-and-conditions/terms-and-conditions-of-sales/>) or other applicable terms. This document does not alter or expand the applicable warranties provided by Diodes. Diodes does not warrant or accept any liability whatsoever in respect of any products purchased through unauthorized sales channel.
6. Diodes products and technology may not be used for or incorporated into any products or systems whose manufacture, use or sale is prohibited under any applicable laws and regulations. Should customers or users use Diodes products in contravention of any applicable laws or regulations, or for any unintended or unauthorized application, customers and users will (a) be solely responsible for any damages, losses or penalties arising in connection therewith or as a result thereof, and (b) indemnify and hold Diodes and its representatives and agents harmless against any and all claims, damages, expenses, and attorney fees arising out of, directly or indirectly, any claim relating to any noncompliance with the applicable laws and regulations, as well as any unintended or unauthorized application.
7. While efforts have been made to ensure the information contained in this document is accurate, complete and current, it may contain technical inaccuracies, omissions and typographical errors. Diodes does not warrant that information contained in this document is error-free and Diodes is under no obligation to update or otherwise correct this information. Notwithstanding the foregoing, Diodes reserves the right to make modifications, enhancements, improvements, corrections or other changes without further notice to this document and any product described herein. This document is written in English but may be translated into multiple languages for reference. Only the English version of this document is the final and determinative format released by Diodes.
8. Any unauthorized copying, modification, distribution, transmission, display or other use of this document (or any portion hereof) is prohibited. Diodes assumes no responsibility for any losses incurred by the customers or users or any third parties arising from any such unauthorized use.

Copyright © 2021 Diodes Incorporated

www.diodes.com