

1 ABSOLUTE MAXIMUM RATINGS

Symbol	Parameter	Value	Unit
V _{CC}	Supply voltage	36	V
V _{in}	Input Voltage	-0.3 to V _{CC} +0.3	V
I _k	Continuous Cathode current range	-100 to 150	mA
T _j	Maximum Junction Temperature	150	°C
R _{thja}	Thermal Resistance Junction to Ambient (SO package)	175	°C/W
ESD	Electrostatic Discharge Protection	1.5	kV

OPERATING CONDITIONS

Symbol	Parameter	Value	Unit
V _{CC}	DC Supply Conditions	2 to 36	V
T _{oper}	Operational temperature	-40 to 105	°C

ELECTRICAL CHARACTERISTICS

V_{CC}⁺ = 5V, V_{CC}⁻ = 0V, T_{amb} = 25°C (unless otherwise specified)

Symbol	Parameter	Min	Typ	Max	Unit
I _{CC}	Total Supply Current, excluding current in the Voltage Reference V _{CC} = +5V, no load V _{CC} = +30V, no load		0.4 1	1 2.5	mA

2 ELECTRICAL CHARACTERISTICS

COMPARATOR (independent comparator)

$V_{CC^+} = +5V$, $V_{CC^-} = GND$, $T_{amb} = +25^{\circ}C$ (unless otherwise specified)

Symbol	Parameter	TSM109			Unit
		Min.	Typ.	Max.	
V_{io}	Input Offset Voltage - note ¹ $T_{amb} = +25^{\circ}C$ $T_{min} \leq T_{amb} \leq T_{max}$		1	5 9	mV
I_{io}	Input Offset Current $T_{amb} = +25^{\circ}C$ $T_{min} \leq T_{amb} \leq T_{max}$		3	25 100	nA
I_{ib}	Input Bias Current (I^+ or I^-) - note ² $T_{amb} = +25^{\circ}C$ $T_{min} \leq T_{amb} \leq T_{max}$		25	250 400	nA
A_{vd}	Large Signal Voltage Gain $V_{CC} = 15V$, $R_L = 15k\Omega$, $V_o = 1V$ to $11V$	50	200		V/mV
V_{icm}	Input Common Mode Voltage Range - note ³ $V_{CC} = 30V$ $T_{amb} = +25^{\circ}C$ $T_{min} \leq T_{amb} \leq T_{max}$	0 0		$V_{CC^+} - 1.5$ $V_{CC^+} - 2$	V
V_{id}	Differential Input Voltage - note ⁴			V_{CC^+}	
V_{OL}	Low Level Output Voltage $V_{id} = -1V$, $I_{sink} = 4mA$ $T_{amb} = +25^{\circ}C$ $T_{min} \leq T_{amb} \leq T_{max}$		250	400 700	mV
I_{OH}	High Level Output Current ($V_{id} = 1V$) $V_{CC} = V_o = 30V$ $T_{amb} = +25^{\circ}C$ $T_{min} \leq T_{amb} \leq T_{max}$		30	150 1	nA μA
I_{sink}	Output Sink Current $V_{id} = 1V$, $V_o = 1.5V$	10	20		mA
t_{re}	Response Time - note ⁵ $R_L = 5.1k\Omega$ connected to V_{CC^+}		1.3		μs
t_{rel}	Large Signal Response Time $R_L = 5.1k\Omega$ connected to V_{CC^+} , $e_1 = TTL$, $V_{(ref)} = +1.4V$		300		ns

- 1) At output switch point, $V_o \approx 1.4V$, $R_s = 0$ with V_{CC^+} from $5V$ to $30V$, and over the full common-mode range ($0V$ to $V_{CC^+} - 1.5V$).
- 2) The direction of the input current is out of the IC due to the PNP input stage. This current is essentially constant, independent of the state of the output, so no loading charge exists on the reference of input lines.
- 3) The input common-mode voltage of either input signal voltage should not be allowed to go negative by more than $0.3V$. The upper end of the common-mode voltage range is $V_{CC^+} - 1.5V$.
- 4) Positive voltage excursions of one input may exceed the power supply level. As long as the other input voltage remains within the common-mode range, the comparator will provide an appropriate output state. The low input voltage state must not be less than $-0.3V$ (or $0.3V$ below the negative power supply, if used).
- 5) The response time specified is for a $100mV$ input step with $5mV$ overdrive. For larger overdrive signals, $300ns$ can be obtained

COMPARATOR (comparator with inverting input connected to the internal Vref)) $V_{CC}^+ = +5V$, $V_{CC}^- = GND$, $T_{amb} = +25^\circ C$ (unless otherwise specified)

Symbol	Parameter	TSM109			Unit
		Min.	Typ.	Max.	
V_{io}	Input Offset Voltage - note ¹ $T_{amb} = +25^\circ C$ $T_{min} \leq T_{amb} \leq T_{max}$		1	5 9	mV
I_{ib}	Input Bias Current for positive input note ² $T_{amb} = +25^\circ C$ $T_{min} \leq T_{amb} \leq T_{max}$		25	250 400	nA
A_{vd}	Large Signal Voltage Gain $V_{CC} = 15V$, $R_L = 15k\Omega$, $V_o = 1V$ to $11V$	50	200		V/mV
V_{id}	Differential Input Voltage -note			V_{CC}^+ -2.5V	V
V_{OL}	Low Level Output Voltage $V_{id} = -1V$, $I_{sink} = 4mA$ $T_{amb} = +25^\circ C$ $T_{min} \leq T_{amb} \leq T_{max}$		250	400 700	mV
I_{OH}	High Level Output Current ($V_{id} = 1V$) $V_{CC} = V_o = 30V$ $T_{amb} = +25^\circ C$ $T_{min} \leq T_{amb} \leq T_{max}$		30	150 1	nA μA
I_{sink}	Output Sink Current $V_{id} = 1V$, $V_o = 1.5V$	10	20		mA
t_{re}	Response Time - note ³ $R_L = 5.1k\Omega$ connected to V_{CC}^+		1.3		μs
t_{rel}	Large Signal Response Time $R_L = 5.1k\Omega$ connected to V_{CC}^+ , $e_1 = TTL$, $V_{(ref)} = +1.4V$		300		ns

- 1) At output switch point, $V_o \approx 1.4V$, $R_s = 0$ with V_{CC}^+ from $5V$ to $30V$, and over the full common-mode range ($0V$ to $V_{CC}^+ - 1.5V$).
- 2) The direction of the input current is out of the IC due to the PNP input stage. This current is essentially constant, independent of the state of the output, so no loading charge exists on the reference of input lines.
- 3) The response time specified is for a $100mV$ input step with $5mV$ overdrive. For larger overdrive signals, $300ns$ can be obtained.

ELECTRICAL CHARACTERISTICS

VOLTAGE REFERENCE

Symbol	Conditions	Value	Unit
I_K	Cathode Current	1 to 100	mA

$T_{amb} = 25^\circ\text{C}$ (unless otherwise specified)

Symbol	Parameter	TSM109A			TSM109			Unit
		Min.	Typ.	Max.	Min.	Typ.	Max.	
V_{ref}	Reference Input Voltage, $I_K = 10\text{ mA}$ $T_{amb} = 25^\circ\text{C}$ $T_{min} \leq T_{amb} \leq T_{max}$	2.490 2.48	2.500	2.510 2.52	2.475 2.45	2.500	2.525 2.55	V
ΔV_{ref}	Reference Input Voltage Deviation Over Temperature Range $I_K = 10\text{ mA}$ $T_{min} \leq T_{amb} \leq T_{max}$		7	30		7	30	mV
$\frac{\Delta V_{ref}}{V_{ref} \Delta T}$	Temperature Coefficient of Reference Input Voltage $I_K = 10\text{ mA}$, $T_{min} \leq T_{amb} \leq T_{max}$		± 13	± 90		± 13	± 90	ppm/ $^\circ\text{C}$
I_{min}	Minimum Cathode Current for Regulation		0.5	1		0.5	1	mA
$ Z_{Vref} $	Dynamic Impedance - note ¹ ΔV_{ref} , $\Delta I_K = 1\text{ to }100\text{ mA}$, $f < 1\text{ KHz}$		0.3	0.65		0.3	0.65	Ω

1) The dynamic impedance is defined as $|Z_{Vref}| = \Delta V_{Vref} / \Delta I_K$

3 PACKAGE MECHANICAL DATA

Plastic DIP-8 MECHANICAL DATA						
DIM.	mm.			inch		
	MIN.	TYP.	MAX.	MIN.	TYP.	MAX.
A		3.3			0.130	
a1	0.7			0.028		
B	1.39		1.65	0.055		0.065
B1	0.91		1.04	0.036		0.041
b		0.5			0.020	
b1	0.38		0.5	0.015		0.020
D			9.8			0.386
E		8.8			0.346	
e		2.54			0.100	
e3		7.62			0.300	
e4		7.62			0.300	
F			7.1			0.280
l			4.8			0.189
L		3.3			0.130	
Z	0.44		1.6	0.017		0.063

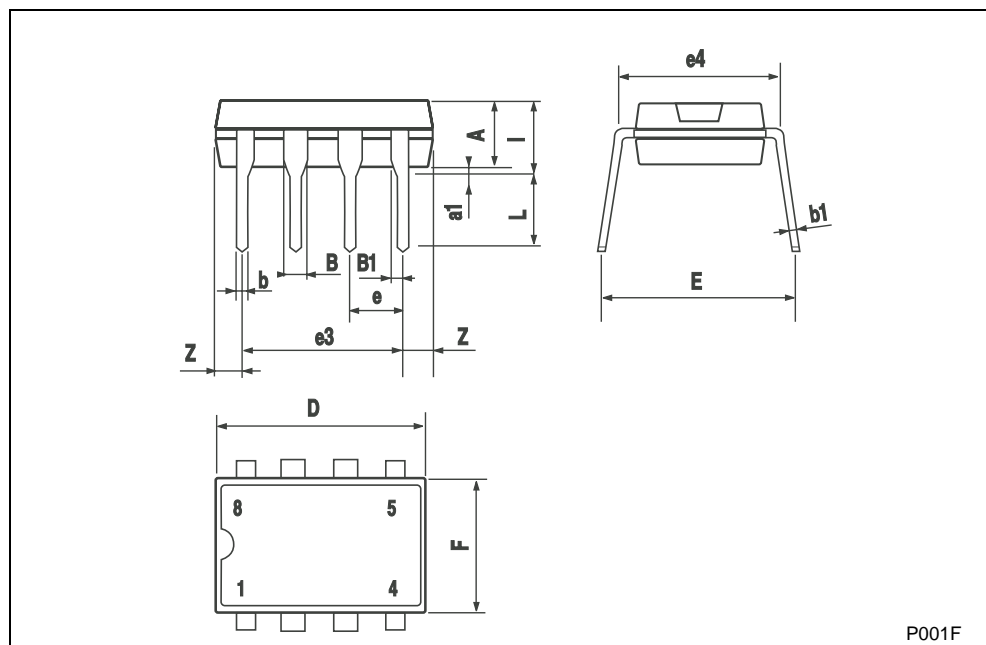

PACKAGE MECHANICAL DATA

SO-8 MECHANICAL DATA						
DIM.	mm.			inch		
	MIN.	TYP.	MAX.	MIN.	TYP.	MAX.
A	1.35		1.75	0.053		0.069
A1	0.10		0.25	0.04		0.010
A2	1.10		1.65	0.043		0.065
B	0.33		0.51	0.013		0.020
C	0.19		0.25	0.007		0.010
D	4.80		5.00	0.189		0.197
E	3.80		4.00	0.150		0.157
e		1.27			0.050	
H	5.80		6.20	0.228		0.244
h	0.25		0.50	0.010		0.020
L	0.40		1.27	0.016		0.050
k	8° (max.)					
ddd			0.1			0.04

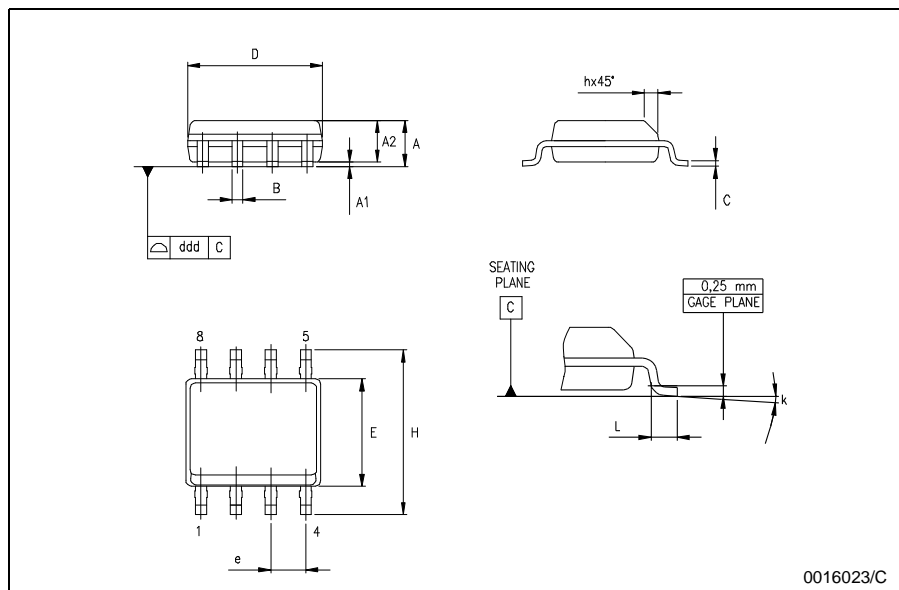

Information furnished is believed to be accurate and reliable. However, STMicroelectronics assumes no responsibility for the consequences of use of such information nor for any infringement of patents or other rights of third parties which may result from its use. No license is granted by implication or otherwise under any patent or patent rights of STMicroelectronics. Specifications mentioned in this publication are subject to change without notice. This publication supersedes and replaces all information previously supplied. STMicroelectronics products are not authorized for use as critical components in life support devices or systems without express written approval of STMicroelectronics.

The ST logo is a registered trademark of STMicroelectronics
 All other names are the property of their respective owners.

© 2004 STMicroelectronics - All Rights Reserved

STMicroelectronics GROUP OF COMPANIES

Australia - Belgium - Brazil - Canada - China - Czech Republic - Finland - France - Germany
 Hong Kong - India - Israel - Italy - Japan - Malaysia - Malta - Morocco - Singapore - Spain
 Sweden - Switzerland - United Kingdom - United States

<http://www.st.com>







Part Number Search

Search For Part #:

Example: [*74*00*](#)

Matching Documents: 1 - 1 of 1

Generic Part Number(s)	Orderable Part Number(s)	Status	Product Page/ Datasheet	Description
TSM109	TSM109AIDT	Active	 	DUAL COMPARATOR AND VOLTAGE REFERENCE Power Management AC-DC Conversion Voltage

Search time: 0.074s



SEARCH



[search the](#)

Part Number Search

Search For Part #:

Example: [*74*00*](#)

Matching Documents: 1 - 1 of 1

Generic Part Number(s)	Orderable Part Number(s)	Status	Product Page/ Datasheet	Description
TSM109	TSM109AID TSM109AIDT	Active Active	 	DUAL COMPARATOR AND VOLTAGE REFERENCE Power Management AC-DC Conversion Voltage

Search time: 0.073s



SEARCH

search th



Part Number Search

Search For Part #:

TSM109AIN

Example: [*74*00*](#)

Matching Documents: 1 - 1 of 1

Generic Part Number(s)	Orderable Part Number(s)	Status	Product Page/ Datasheet	Description
TSM109	TSM109AIN	NRND	 	DUAL COMPARATOR AND VOLTAGE REFERENCE Power Management AC-DC Conversion Voltage

Search time: 0.074s



SEARCH



search th

Part Number Search

Search For Part #:

Example: [*74*00*](#)

Matching Documents: 1 - 1 of 1

Generic Part Number(s)	Orderable Part Number(s)	Status	Product Page/ Datasheet	Description
TSM109	TSM109IDT	Active	 	DUAL COMPARATOR AND VOLTAGE REFERENCE Power Management AC-DC Conversion Voltage

Search time: 0.074s



SEARCH

search th



Part Number Search

Search For Part #:

TSM109ID

Example: [*74*00*](#)

Matching Documents: 1 - 1 of 1

Generic Part Number(s)	Orderable Part Number(s)	Status	Product Page/ Datasheet	Description
TSM109	TSM109ID TSM109IDT	Active Active	 	DUAL COMPARATOR AND VOLTAGE REFERENCE Power Management AC-DC Conversion Voltage

Search time: 0.074s



SEARCH



search th

Part Number Search

Search For Part #:

Example: [*74*00*](#)

Matching Documents: 1 - 1 of 1

Generic Part Number(s)	Orderable Part Number(s)	Status	Product Page/ Datasheet	Description
TSM109	TSM109IN	NRND	 	DUAL COMPARATOR AND VOLTAGE REFERENCE Power Management AC-DC Conversion Voltage

Search time: 0.074s

Mouser Electronics

Authorized Distributor

Click to View Pricing, Inventory, Delivery & Lifecycle Information:

[STMicroelectronics:](#)

[TSM109ID](#) [TSM109AID](#) [TSM109AIDT](#) [TSM109IDT](#)