

Product Specifications

| | | | |
|--------|------------------------------|--|--|
| Rating | Current rating 0.5 A (Note1) | Operating temperature range -55°C to +85°C (Note 2) | Storage temperature range -10°C to +50°C (Note 3) |
| | Voltage rating 50 V AC | Operating humidity range Relative humidity 90% max. (No condensation) | Storage humidity range Relative humidity 90% max. (No condensation) |

| | | |
|-------------------------|---------------|---------------------------------------|
| Recommended FPC, FFC | FH19C Series | Thickness: = 0.2 ± 0.03mm Gold plated |
| | FH19SC Series | Thickness: = 0.3 ± 0.03mm Gold plated |

| Item | Specification | Conditions |
|--|---|---|
| 1. Insulation resistance | 500 M ohms min. | 100 V DC |
| 2. Withstanding voltage | No flashover or insulation breakdown | 150 V AC/1 minute |
| 3. Contact resistance | 100 m ohms max. *Including FPC/FFC conductor resistance | 1 mA |
| 4. Durability (insertion/ withdrawal) | Contact resistance: 100 m ohms max. No damage, cracks, or parts dislocation. | 20 cycles |
| 5. Vibration | No electrical discontinuity of 1 μs or more. Contact resistance: 100 m ohms max. No damage, cracks, or parts dislocation. | Frequency: 10 to 55 Hz, single amplitude of 0.75mm, 10 cycles in each of the 3 directions |
| 6. Shock | No electrical discontinuity of 1 μs. min. Contact resistance: 100 m ohms max. No damage, cracks, or parts dislocation. | Acceleration of 981 m/s ² , 6 ms duration, sine half-wave waveform, 3 cycles in each of the 3 axis. |
| 7. Humidity (Steady state) | Contact resistance: 100 m ohms max. Insulation resistance: 100 M ohms min. No damage, cracks, or parts dislocation. | 96 hours at temperature of 40°C and humidity of 90 to 95% |
| 8. Temperature cycle | Contact resistance: 100 m ohms max. Insulation resistance: 100 M ohms min. No damage, cracks, or parts dislocation. | Temperature: -55°C → +15°C to +35°C → +85°C → +15°C to +35°C Time : 30 → 2 to 3 → 30 → 2 to 3(Minutes) 5 cycles |
| 9. Resistance to soldering heat | No deformation of components affecting performance. | Reflow: At the recommended temperature profile Manual soldering: 350°C±5°C for 5 seconds |

Note 1: When passing the current through all of the contacts, use 70% of the current rating.

Note 2: Includes temperature rise caused by current flow.

Note 3: The term "storage" refers to products stored for long period of time prior to mounting and use. Operating Temperature Range and Humidity range covers non-conducting condition of installed connectors in storage, shipment or during transportation. Information

Note 4: Information contained in this catalog represents general requirements for this Series. Contact us for the drawings and specifications for a specific part number shown.

Materials

| Part | Material | Finish | Remarks |
|----------------|-----------------|---|---------|
| Insulator | LCP | Color: Beige | UL94V-0 |
| Actuator | PPS/LCP | Color: Brown (FH19C Series) Color: Black (FH19SC Series) | |
| Contacts | Phosphor bronze | Gold plated | — |
| Metal fittings | Phosphor bronze | Pure tin reflow plated | — |

Ordering information

FH 19 C - 30S - 0.5 SH (05)

①
②
③
④
⑤
⑥
⑦

| ① Series name : FH | ⑤ Contact pitch : 0.5mm | | | | | | | | | | | | | | | | | | | | | | | | | | | | | |
|---|---|-------------------|------|--------------|-----|--------------|-------|----------------------|---|------|-----|---|---|------|--------|----------------------|------|---|----|---|------|---|--------------|----------------------|---|------|-----|---|---|------|
| ② Series No. : 19 | ⑥ Terminal type SH: SMT horizontal mounting type | | | | | | | | | | | | | | | | | | | | | | | | | | | | | |
| ③ C : FPC/FFC thickness : 0.2mm SC : FPC/FFC thickness : 0.3mm | ⑦ Material and plating specifications : | | | | | | | | | | | | | | | | | | | | | | | | | | | | | |
| ④ No. of contacts : 4 to 50 | | | | | | | | | | | | | | | | | | | | | | | | | | | | | | |
| <table border="1" style="width: 100%; border-collapse: collapse;"> <thead> <tr> <th colspan="2">Actuator material</th> <th>PPS</th> <th>LCP</th> <th>Halogen Free</th> </tr> </thead> <tbody> <tr> <td rowspan="2">FH19C</td> <td>Contact: Gold plated</td> <td>—</td> <td>(05)</td> <td rowspan="2">YES</td> </tr> <tr> <td>Contact: Gold plating with nickel barrier</td> <td>—</td> <td>(10)</td> </tr> <tr> <td rowspan="2">FH19SC</td> <td>Contact: Gold plated</td> <td>(05)</td> <td>—</td> <td rowspan="2">NO</td> </tr> <tr> <td>Contact: Gold plating with nickel barrier</td> <td>(06)</td> <td>—</td> </tr> <tr> <td rowspan="2">4 to 10 pos.</td> <td>Contact: Gold plated</td> <td>—</td> <td>(05)</td> <td rowspan="2">YES</td> </tr> <tr> <td>Contact: Gold plating with nickel barrier</td> <td>—</td> <td>(09)</td> </tr> </tbody> </table> | | Actuator material | | PPS | LCP | Halogen Free | FH19C | Contact: Gold plated | — | (05) | YES | Contact: Gold plating with nickel barrier | — | (10) | FH19SC | Contact: Gold plated | (05) | — | NO | Contact: Gold plating with nickel barrier | (06) | — | 4 to 10 pos. | Contact: Gold plated | — | (05) | YES | Contact: Gold plating with nickel barrier | — | (09) |
| Actuator material | | PPS | LCP | Halogen Free | | | | | | | | | | | | | | | | | | | | | | | | | | |
| FH19C | Contact: Gold plated | — | (05) | YES | | | | | | | | | | | | | | | | | | | | | | | | | | |
| | Contact: Gold plating with nickel barrier | — | (10) | | | | | | | | | | | | | | | | | | | | | | | | | | | |
| FH19SC | Contact: Gold plated | (05) | — | NO | | | | | | | | | | | | | | | | | | | | | | | | | | |
| | Contact: Gold plating with nickel barrier | (06) | — | | | | | | | | | | | | | | | | | | | | | | | | | | | |
| 4 to 10 pos. | Contact: Gold plated | — | (05) | YES | | | | | | | | | | | | | | | | | | | | | | | | | | |
| | Contact: Gold plating with nickel barrier | — | (09) | | | | | | | | | | | | | | | | | | | | | | | | | | | |

■Connector Dimension

[FH19C Series]

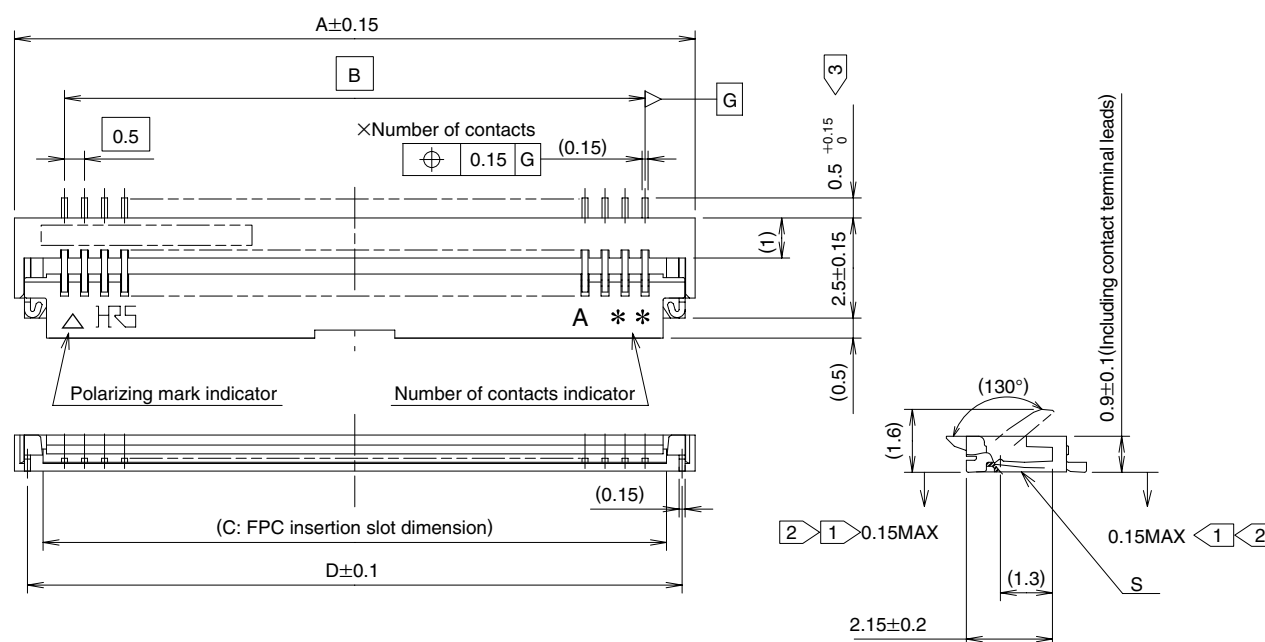

- Notes
- ① The coplanarity of each terminal lead and metal fitting is within 0.1
 - ② The contact terminal lead position indicates the dimension from the bottom surface of the insulator body.
 - ③ Difference between terminal contact to be max. 0.1mm.
 - 4 Packaged on tape and reel only. Check packaging specification.
 - 5 Any discoloration of the plastic compound will NOT AFFECT form, fit or function of the connector.
 - 6 After reflow, the terminal plating may change color, however this does not represent a quality issue.

Unit: mm

| Part Number | CL No. | Number of Contacts | A | B | C | D |
|---------------------|----------------|--------------------|------|------|-------|-------|
| FH19C- 4S-0.5SH(**) | 580-0410-1-**- | 4 | 4 | 1.5 | 2.57 | 3.35 |
| FH19C- 5S-0.5SH(**) | 580-0418-3-**- | 5 | 4.5 | 2 | 3.07 | 3.85 |
| FH19C- 6S-0.5SH(**) | 580-0409-2-**- | 6 | 5 | 2.5 | 3.57 | 4.35 |
| FH19C- 7S-0.5SH(**) | 580-0411-4-**- | 7 | 5.5 | 3 | 4.07 | 4.85 |
| FH19C- 8S-0.5SH(**) | 580-0404-9-**- | 8 | 6 | 3.5 | 4.57 | 5.35 |
| FH19C- 9S-0.5SH(**) | 580-0403-6-**- | 9 | 6.5 | 4 | 5.07 | 5.85 |
| FH19C-10S-0.5SH(**) | 580-0412-7-**- | 10 | 7 | 4.5 | 5.57 | 6.35 |
| FH19C-12S-0.5SH(**) | 580-0413-0-**- | 12 | 8 | 5.5 | 6.57 | 7.35 |
| FH19C-13S-0.5SH(**) | 580-0405-1-**- | 13 | 8.5 | 6 | 7.07 | 7.85 |
| FH19C-15S-0.5SH(**) | 580-0406-4-**- | 15 | 9.5 | 7 | 8.07 | 8.85 |
| FH19C-17S-0.5SH(**) | 580-0408-0-**- | 17 | 10.5 | 8 | 9.07 | 9.85 |
| FH19C-20S-0.5SH(**) | 580-0402-3-**- | 20 | 12 | 9.5 | 10.57 | 11.35 |
| FH19C-21S-0.5SH(**) | 580-0414-2-**- | 21 | 12.5 | 10 | 11.07 | 11.85 |
| FH19C-24S-0.5SH(**) | 580-0407-7-**- | 24 | 14 | 11.5 | 12.57 | 13.35 |
| FH19C-27S-0.5SH(**) | 580-0401-0-**- | 27 | 15.5 | 13 | 14.07 | 14.85 |
| FH19C-30S-0.5SH(**) | 580-0400-8-**- | 30 | 17 | 14.5 | 15.57 | 16.35 |
| FH19C-34S-0.5SH(**) | 580-0419-6-**- | 34 | 19 | 16.5 | 17.57 | 18.35 |
| FH19C-40S-0.5SH(**) | 580-0416-8-**- | 40 | 22 | 19.5 | 20.57 | 21.35 |
| FH19C-50S-0.5SH(**) | 580-0417-0-**- | 50 | 27 | 24.5 | 25.57 | 26.35 |

Note1: Embossed tape reel packaging (5,000 pieces/reel).

Order by number of reels.

Note2: **Specification. Refer to ordering information.

[FH19SC Series]

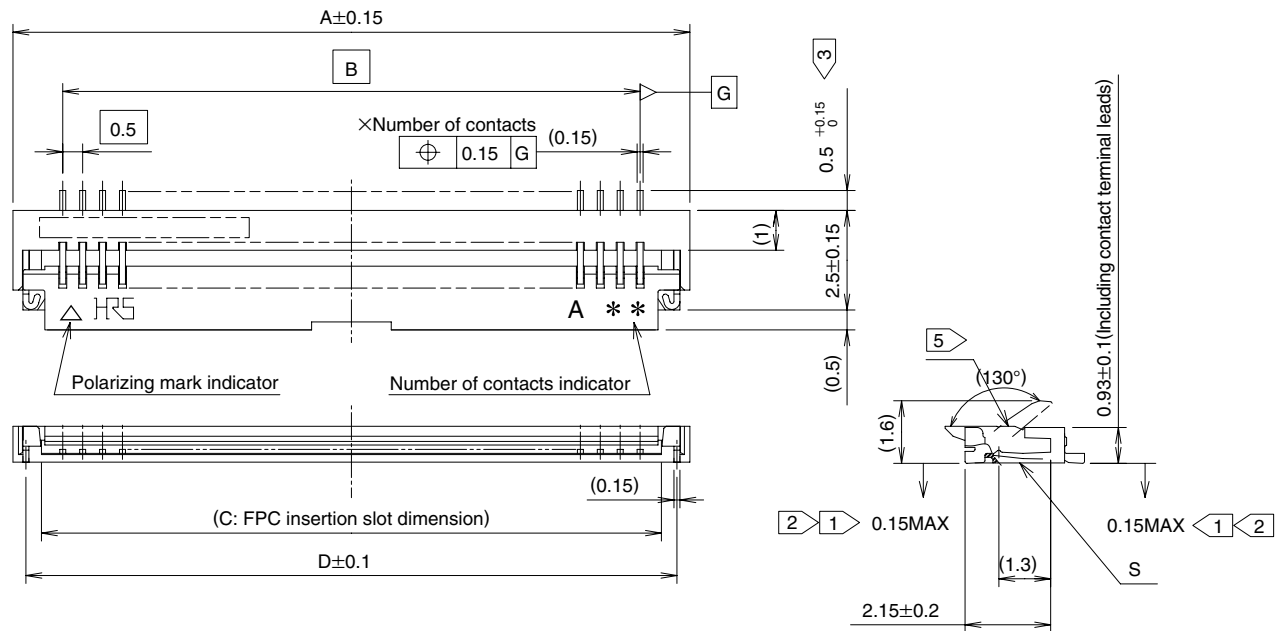

- Notes
- 1 The coplanarity of each terminal lead and metal fitting is within 0.1
 - 2 The contact terminal lead position indicates the dimension from the bottom surface of the insulator body.
 - 3 Difference between terminal contact to be max. 0.1mm.
 - 4 Any discoloration of the plastic compound will NOT AFFECT form, fit or function of the connector.
 - 5 The contacts are protruding 0.03mm max. from the housing top surface.
 - 6 Packaged on tape and reel only. Check packaging specification.
 - 7 After reflow, the terminal plating may change color, however this does not represent a quality issue.

Unit: mm

| Part Number | CL No. | Number of Contacts | A | B | C | D |
|----------------------|----------------|--------------------|------|------|-------|-------|
| FH19SC- 4S-0.5SH(**) | 580-0517-5-**- | 4 | 4 | 1.5 | 2.57 | 3.35 |
| FH19SC- 5S-0.5SH(**) | 580-0515-0-**- | 5 | 4.5 | 2 | 3.07 | 3.85 |
| FH19SC- 6S-0.5SH(**) | 580-0501-5-**- | 6 | 5 | 2.5 | 3.57 | 4.35 |
| FH19SC- 8S-0.5SH(**) | 580-0520-0-**- | 8 | 6 | 3.5 | 4.57 | 5.35 |
| FH19SC- 9S-0.5SH(**) | 580-0507-1-**- | 9 | 6.5 | 4 | 5.07 | 5.85 |
| FH19SC-10S-0.5SH(**) | 580-0508-4-**- | 10 | 7 | 4.5 | 5.57 | 6.35 |
| FH19SC-12S-0.5SH(**) | 580-0512-1-**- | 12 | 8 | 5.5 | 6.57 | 7.35 |
| FH19SC-13S-0.5SH(**) | 580-0518-8-**- | 13 | 8.5 | 6 | 7.07 | 7.85 |
| FH19SC-14S-0.5SH(**) | 580-0509-7-**- | 14 | 9 | 6.5 | 7.57 | 8.35 |
| FH19SC-15S-0.5SH(**) | 580-0503-0-**- | 15 | 9.5 | 7 | 8.07 | 8.85 |
| FH19SC-16S-0.5SH(**) | 580-0521-2-**- | 16 | 10 | 7.5 | 8.57 | 9.35 |
| FH19SC-17S-0.5SH(**) | 580-0504-3-**- | 17 | 10.5 | 8 | 9.07 | 9.85 |
| FH19SC-18S-0.5SH(**) | 580-0519-0-**- | 18 | 11 | 8.5 | 9.57 | 10.35 |
| FH19SC-20S-0.5SH(**) | 580-0502-8-**- | 20 | 12 | 9.5 | 10.57 | 11.35 |
| FH19SC-21S-0.5SH(**) | 580-0505-6-**- | 21 | 12.5 | 10 | 11.07 | 11.85 |
| FH19SC-22S-0.5SH(**) | 580-0506-9-**- | 22 | 13 | 10.5 | 11.57 | 12.35 |
| FH19SC-24S-0.5SH(**) | 580-0511-9-**- | 24 | 14 | 11.5 | 12.57 | 13.35 |
| FH19SC-26S-0.5SH(**) | 580-0510-6-**- | 26 | 15 | 12.5 | 13.57 | 14.35 |
| FH19SC-27S-0.5SH(**) | 580-0516-2-**- | 27 | 15.5 | 13 | 14.07 | 14.85 |
| FH19SC-28S-0.5SH(**) | 580-0513-4-**- | 28 | 16 | 13.5 | 14.57 | 15.35 |
| FH19SC-30S-0.5SH(**) | 580-0500-2-**- | 30 | 17 | 14.5 | 15.57 | 16.35 |
| FH19SC-32S-0.5SH(**) | 580-0514-7-**- | 32 | 18 | 15.5 | 16.57 | 17.35 |
| FH19SC-40S-0.5SH(**) | 580-0522-5-**- | 40 | 22 | 19.5 | 20.57 | 21.35 |
| FH19SC-45S-0.5SH(**) | 580-0523-8-**- | 45 | 24.5 | 22 | 23.07 | 23.85 |
| FH19SC-50S-0.5SH(**) | 580-0524-0-**- | 50 | 27 | 24.5 | 25.57 | 26.35 |

Note1: Embossed tape reel packaging (5,000 pieces/reel) .

Order by number of reels.

Note2: **Specification. Refer to ordering information.

Recommended PCB Land and Metal Mask Dimensions

[Common to FH19C & FH19SC Series]

Recommended metal mask thickness: 0.10 mm.

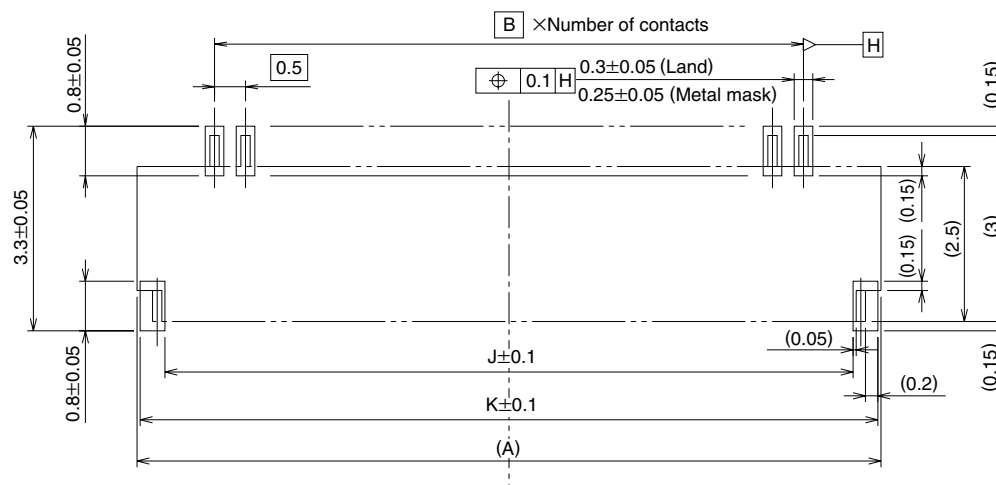

Recommended FPC, FFC Dimensions

[Common to FH19C & FH19SC Series]

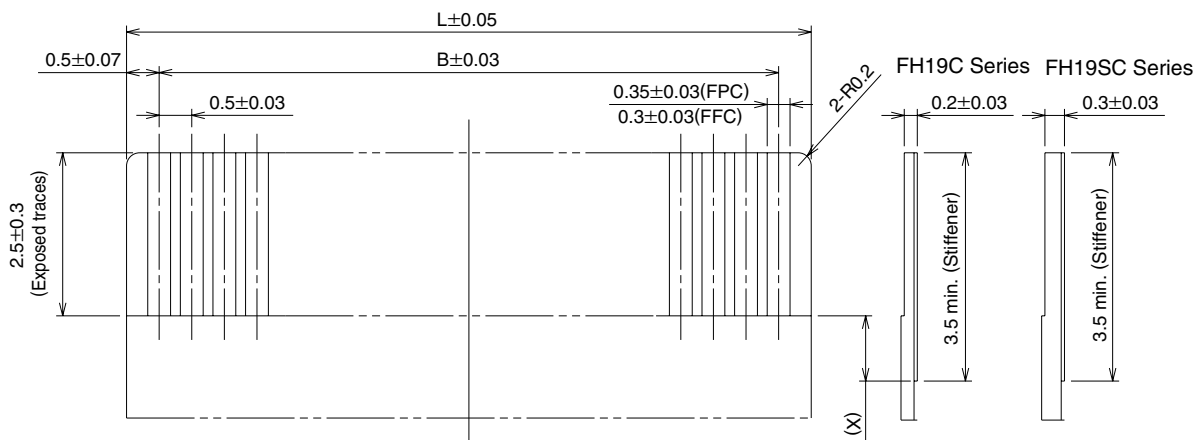

Note 1: Stiffener dimension should be 3.5mm min., and X dimension should be 0.5mm for improved flexibility of FPC.

Unit: mm

| Number of Contacts | A | B | J | K | L |
|--------------------|------|-----|------|------|-----|
| 4 | 4.0 | 1.5 | 3.1 | 3.9 | 2.5 |
| 5 | 4.5 | 2.0 | 3.6 | 4.4 | 3.0 |
| 6 | 5.0 | 2.5 | 4.1 | 4.9 | 3.5 |
| 7 | 5.5 | 3.0 | 4.6 | 5.4 | 4.0 |
| 8 | 6.0 | 3.5 | 5.1 | 5.9 | 4.5 |
| 9 | 6.5 | 4.0 | 5.6 | 6.4 | 5.0 |
| 10 | 7.0 | 4.5 | 6.1 | 6.9 | 5.5 |
| 12 | 8.0 | 5.5 | 7.1 | 7.9 | 6.5 |
| 13 | 8.5 | 6.0 | 7.6 | 8.4 | 7.0 |
| 14 | 9.0 | 6.5 | 8.1 | 8.9 | 7.5 |
| 15 | 9.5 | 7.0 | 8.6 | 9.4 | 8.0 |
| 16 | 10.0 | 7.5 | 9.1 | 9.9 | 8.5 |
| 17 | 10.5 | 8.0 | 9.6 | 10.4 | 9.0 |
| 18 | 11.0 | 8.5 | 10.1 | 10.9 | 9.5 |

Unit: mm

| Number of Contacts | A | B | J | K | L |
|--------------------|------|------|------|------|------|
| 20 | 12.0 | 9.5 | 11.1 | 11.9 | 10.5 |
| 21 | 12.5 | 10.0 | 11.6 | 12.4 | 11.0 |
| 22 | 13.0 | 10.5 | 12.1 | 12.9 | 11.5 |
| 24 | 14.0 | 11.5 | 13.1 | 13.9 | 12.5 |
| 26 | 15.0 | 12.5 | 14.1 | 14.9 | 13.5 |
| 27 | 15.5 | 13.0 | 14.6 | 15.4 | 14.0 |
| 28 | 16.0 | 13.5 | 15.1 | 15.9 | 14.5 |
| 30 | 17.0 | 14.5 | 16.1 | 16.9 | 15.5 |
| 32 | 18.0 | 15.5 | 17.1 | 17.9 | 16.5 |
| 34 | 19.0 | 16.5 | 18.1 | 18.9 | 17.5 |
| 40 | 22.0 | 19.5 | 21.1 | 21.9 | 20.5 |
| 45 | 24.5 | 22.0 | 23.6 | 24.4 | 23.0 |
| 50 | 27.0 | 24.5 | 26.1 | 26.9 | 25.5 |

■FH19C & FH19SC Series FPC/FFC Construction (Recommended Specifications)

1. Using Single-sided FPC

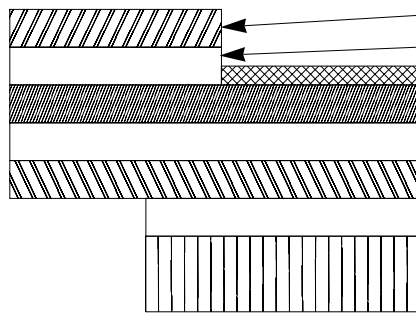

FPC : Flexible Printed Circuit

| Material Name | Material | Thickness (μm) | |
|---------------------------------|--|-----------------------------|--------|
| | | FH19C | FH19SC |
| Covering layer film | Polyimide 1 mil thick | (25) | (25) |
| Cover adhesive | | (25) | (25) |
| Surface treatment | Nickel under plated 1 to $5\mu\text{m}$ / Gold plated $0.2\mu\text{m}$ | 3 | 3 |
| Copper foil | Cu 1oz | 35 | 35 |
| Base adhesive | Thermosetting adhesive | 25 | 25 |
| Base film | Polyimide 1 mil thick | 25 | 25 |
| Reinforcement material adhesive | Thermosetting adhesive | 30 | 30 |
| Stiffener | Polyimide FH19C : 3mil FH19SC : 7mil | 75 | 175 |
| Total | | 193 | 293 |

2. Using Double-sided FPC

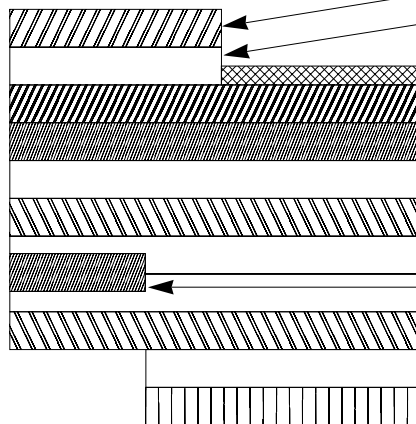

FPC : Flexible Printed Circuit

| Material Name | Material | Thickness (μm) | |
|---------------------------------|--|-----------------------------|--------|
| | | FH19C | FH19SC |
| Covering layer film | Polyimide 1 mil thick | (25) | (25) |
| Cover adhesive | | (25) | (25) |
| Surface treatment | Nickel under plated 1 to $5\mu\text{m}$ / Gold plated $0.2\mu\text{m}$ | 3 | 3 |
| Through-hole copper | Cu | 15 | 15 |
| Copper foil | Cu 1/2oz | 18 | 18 |
| Base adhesive | Thermosetting adhesive | 18 | 18 |
| Base film | Polyimide 1 mil thick | 25 | 25 |
| Base adhesive | | 18 | 18 |
| Copper foil | Cu 1/2oz | 18 | 18 |
| Cover adhesive | Thermosetting adhesive | 25 | 25 |
| Covering layer film | Polyimide 1 mil thick | 25 | 25 |
| Reinforcement material adhesive | Thermosetting adhesive | 25 | 50 |
| Stiffener | Polyimide FH19C : 1mil FH19SC : 4mil | 25 | 100 |
| Total | | 197 | 297 |

3. Using FFC (Flexible Flat Cable)

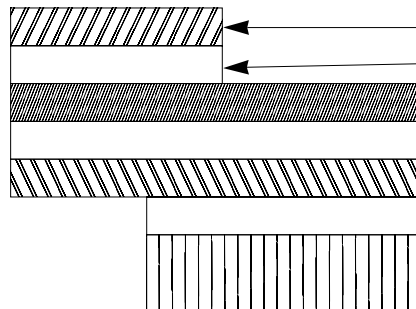

FFC : Flexible Flat Cable

| Material Name | Material | Thickness (μm) | |
|---|------------------------------|-----------------------------|--------|
| | | FH19C | FH19SC |
| Polyester film | | (12) | (12) |
| Adhesive | Polyester thermoplastic type | (30) | (30) |
| (Nickel under plated / Gold plated), soft copper film | | 35 | 35 |
| Adhesive | Polyester | 30 | 30 |
| Polyester | | 12 | 12 |
| Adhesive | Polyester | 30 | 30 |
| Stiffener | Polyester | 100 | 188 |
| Total | | 207 | 295 |

* Practical tolerance of thickness dimension is $\pm 20\mu\text{m}$ (i.e., 187 to $227\mu\text{m}$).

4. Precautions

1. This specification is a recommendation for the construction of the FH19C/ Series FPC and FFC ($t=0.2\pm 0.03$).
2. For details about the construction, please contact the FPC/FFC manufacturers.

■ Packaging Specifications

[Common to FH19C & FH19SC Series]

● Embossed Carrier Tape Dimensions

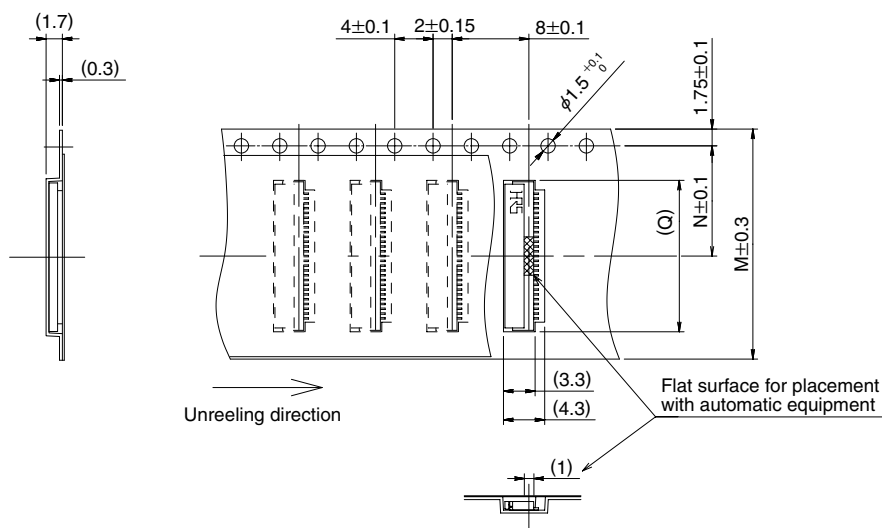

● Reel Dimensions

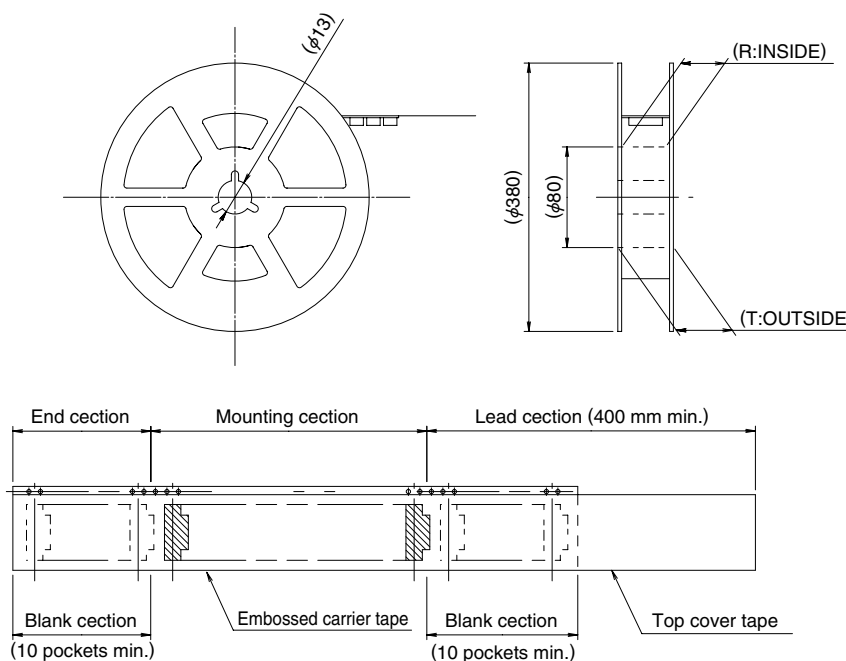

Unit: mm

| Number of Contacts | M | N | Q | R | T |
|--------------------|----|------|------|------|------|
| 4 | 16 | 7.5 | 4.3 | 17.4 | 21.4 |
| 5 | 16 | 7.5 | 4.8 | 17.4 | 21.4 |
| 6 | 16 | 7.5 | 5.3 | 17.4 | 21.4 |
| 7 | 16 | 7.5 | 5.8 | 17.4 | 21.4 |
| 8 | 16 | 7.5 | 6.3 | 17.4 | 21.4 |
| 9 | 16 | 7.5 | 6.8 | 17.4 | 21.4 |
| 10 | 16 | 7.5 | 7.3 | 17.4 | 21.4 |
| 12 | 16 | 7.5 | 8.3 | 17.4 | 21.4 |
| 13 | 16 | 7.5 | 8.8 | 17.4 | 21.4 |
| 14 | 16 | 7.5 | 9.3 | 17.4 | 21.4 |
| 15 | 16 | 7.5 | 9.8 | 17.4 | 21.4 |
| 16 | 24 | 11.5 | 10.3 | 25.4 | 29.4 |
| 17 | 24 | 11.5 | 10.8 | 25.4 | 29.4 |
| 18 | 24 | 11.5 | 11.3 | 25.4 | 29.4 |

Unit: mm

| Number of Contacts | M | N | Q | R | T |
|--------------------|----|------|------|------|------|
| 20 | 24 | 11.5 | 12.3 | 25.4 | 29.4 |
| 21 | 24 | 11.5 | 12.8 | 25.4 | 29.4 |
| 22 | 24 | 11.5 | 13.3 | 25.4 | 29.4 |
| 24 | 24 | 11.5 | 14.3 | 25.4 | 29.4 |
| 26 | 24 | 11.5 | 15.3 | 25.4 | 29.4 |
| 27 | 24 | 11.5 | 15.8 | 25.4 | 29.4 |
| 28 | 24 | 11.5 | 16.3 | 25.4 | 29.4 |
| 30 | 24 | 11.5 | 17.3 | 25.4 | 29.4 |
| 32 | 32 | 14.2 | 18.3 | 33.4 | 37.4 |
| 34 | 32 | 14.2 | 19.3 | 33.4 | 37.4 |
| 40 | 44 | 20.2 | 22.3 | 45.4 | 49.4 |
| 45 | 44 | 20.2 | 24.8 | 45.4 | 49.4 |
| 50 | 44 | 20.2 | 27.3 | 45.4 | 49.4 |

Note: 5,000 pieces per reel.

Embossed tape 32 mm or wider will have perforated feed holes on two sides.

■Recommended Temperature Profile

[For FH19C & FH19SC Series]

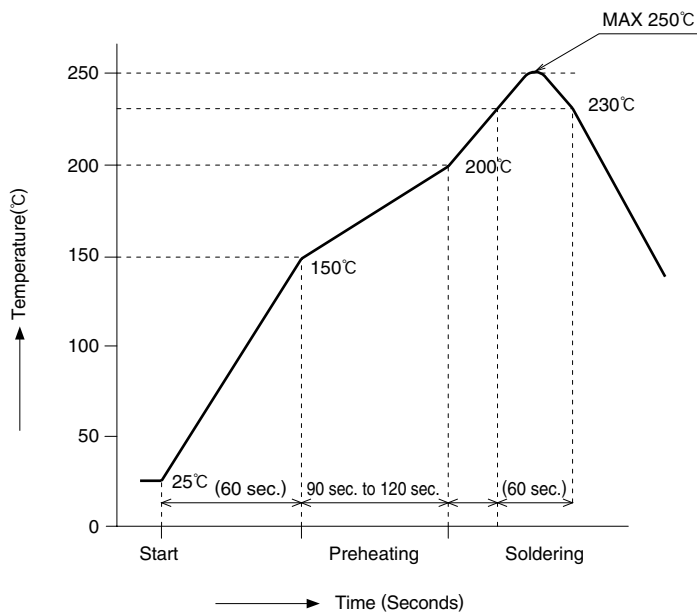

HRS test condition

| | |
|--------------------|---|
| Solder method | :Reflow, IR/hot air |
| Solder composition | :Paste, 96.5%Sn/3.0%Ag/0.5%Cu (Senju Metal Industry, Co., Ltd.'s Part Number:M705-221CM5-32-10.5) |
| Test board | :Glass epoxy 45mm×100mm×1.6mm thick |
| Land dimensions | :0.3mm×0.8mm |
| Metal mask | :0.25mm×0.8mm×0.1mm |

This temperature profile is based on the above conditions. In individual applications the actual temperature may vary, depending on solder paste type, volume/thickness and board size/thickness. Consult your solder paste and equipment manufacturer for specific recommendations.

■ Operation and Precautions

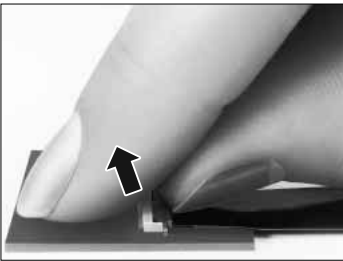
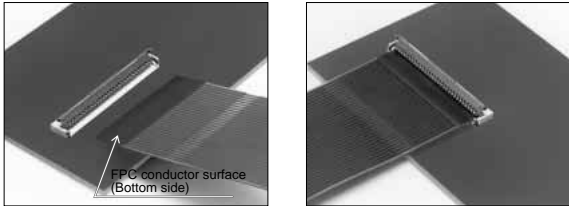
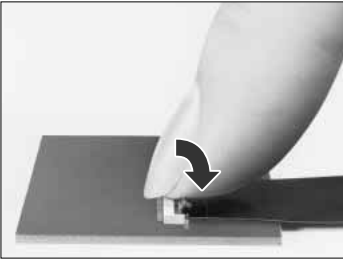
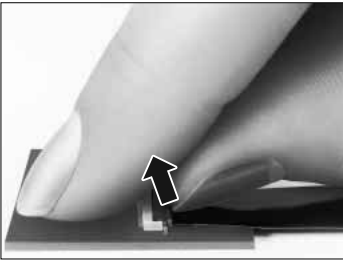
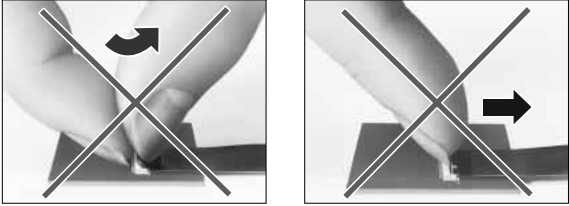
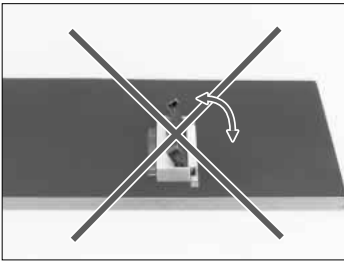
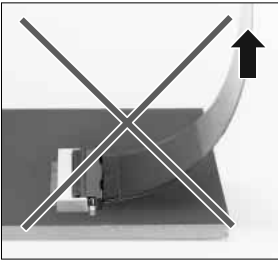
| Operation | Precautions |
|--|---|
| <p>1. FPC/FFC Termination procedure. Connector installed on the board.</p> <p>1) Lift up the actuator. Use thumb or index finger.</p>  <p>2) Assure that the FPC/FFC is fully inserted parallel to mounting surface, with the exposed conductive traces facing down.</p>  <p>3) Rotate down the actuator until firmly closed. It is critical that the inserted FPC/FFC is not moved and remains fully inserted. Should the FPC/FFC be moved, open the actuator and repeat the process, starting with Step 1 above.</p>  <p>2. FPC/FFC Removal</p> <p>1) Lift up the actuator.</p> <p>2) Carefully remove the FPC/FFC.</p>  | <p>1) Do not apply excessive force or use any type of tool to operate the actuator.</p>  <p>2) The connector will assure reliable performance when the actuator is open to 130° maximum. Do not exceed this angle, as this may cause permanent damage to the connector.</p>  <p>3) Application of excessive force to the inserted FPC/FFC may cause damage to connector and may affect the reliability of electrical connection. If specific application requires continuous or repeated pull or bend of the inserted FPC/FFC, assure that the forces are NOT transmitted directly to the connector.</p>  |

Mouser Electronics

Authorized Distributor

Click to View Pricing, Inventory, Delivery & Lifecycle Information:

[Hirose Electric:](#)

[FH19SC-4S-0.5SH\(05\)](#) [FH19C-21S-0.5SH\(05\)](#) [FH19S-24S-0.5SH\(51\)](#) [FH19C-4S-0.5SH\(25\)](#) [FH19SC-13S-0.5SH\(10\)](#) [FH19SC-16S-0.5SH\(10\)](#) [FH19SC-17S-0.5SH\(10\)](#) [FH19SC-21S-0.5SH\(10\)](#) [FH19SC-28S-0.5SH\(10\)](#)
[FH19SC-40S-0.5SH\(06\)](#)