











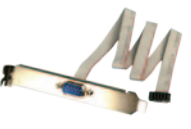







Cables and Connectors *Paralle / Serial cable*

	Serial cable				
					
Model Name	45002-008103-RS	19800-000300-100-RS	19800-010900-200-RS	19800-000051-RS	19800-003600-100-RS
Cable type	Serial port	Serial port cable	Serial port cable	Serial port cable	Serial port cable
Board side	N/A	10-pin (2x5) connector (2.0 mm)	10-pin (2x5) connector (2.54 mm)	2 x 10-pin (2x5) connector (2.54 mm)	2 x 10-pin (2x5) connector (2.54mm)
Board side pitch	2.54 mm	2.0 mm	2.54 mm	2.54 mm	2.54 mm
Device side	2 x DE9M	DE9M	DE9M	2 x DE9M	2 x DE9M
Bracket	Yes	Yes	Yes	Yes	Yes
Length	9 CM	30 cm	50 cm	23 cm	40 cm





	Serial cable				
					
Model Name	19800-000112-RS	32205-000702-100-RS	32200-000049-RS	32205-001203-200-RS	32205-002000-100-RS
Cable type	Serial port cable	Serial port cable	Serial port cable	Serial port cable	Serial port cable
Board side	2 x 10-pin (2x5) connector (2.0 mm)	10-pin (2x5) connector (2.54 mm)	10-pin (2x5) connector (2.0 mm)	40-pin (2x20) connector (2.54 mm)	40-pin (2x20) connector (2.0 mm)
Board side pitch	2.0 mm	2.54 mm	2.0 mm	2.54 mm	2.0 mm
Device side	2 x DE9M	DE9M	DE9M	4 x DE9M	4 x DE9M
Bracket	Yes	No	No	No	No
Length	30 cm	23 cm	20 cm	40/40/40 cm	30 cm





	Serial cable				
					
Model Name	32200-025401-RS	32205-002500-100-RS	19800-004400-200-RS	19800-004300-100-RS	32200-026500-RS
Cable type	Serial port cable	RS-422/485 cable	RS-232 & RS-422/485 cable	RS-232 & RS-422/485 cable	RS-232 & RS-422/485 cable
Board side	40-pin (2x20) connector (2.0 mm)	16-pin (2x8) connector (2.54 mm)	14-pin (2x7) connector (2.54 mm)	14-pin (2x7) connector (2.0 mm)	14-pin (2x7) connector (2.0 mm)
Board side pitch	2.0 mm	2.54 mm	2.54 mm	2.0 mm	2.0 mm
Device side	4 x DE9M	4 x DE9M	2 x DE9M	2 x DE9M	2 x DE9M
Bracket	No	No	Yes	Yes	No
Length	30 cm	12 cm	25.5 cm	25 cm	29 cm





	Serial cable		Paralle cable		
					
Model Name	32205-003700-100-RS	32205-003800-300-RS	19800-000049-RS	19800-003500-100-RS	32200-015100-RS
Cable type	RS-232 & RS-422/485 cable	RS-422/485 cable	Parallel port cable	Parallel and serial port cable	Parallel port cable
Board side	14-pin (2x7) connector (2.0 mm)	4-pin (1x4) connector (2.0 mm)	26-pin (2x13) connector (2.54 mm)	26-pin (2x13) connector (2.0 mm) 10-pin (2x5) connector (2.0 mm)	26-pin (2x13) connector (2.0 mm)
Board side pitch	2.0 mm	2.0 mm	2.54 mm	2.0 mm	2.0 mm
Device side	2 x DE9M	DE9M	DB25F	DB25F + DE9M	DB25F
Bracket	No	No	Yes	Yes	No
Length	23 cm	20 cm	24 cm	24 cm	28 cm





Part numbers listed in the product catalog are for reference purposes. IEI reserves the right to implement substitution parts when the function is not affected.

Cables and Connectors *USB / 1394 / Y Cable*

	USB cable			
				
Model Name	32001-010800-100-RS	32001-006404-100-RS	19800-000100-200-RS	19800-003100-300-RS
Cable type	USB cable	USB cable	USB cable	USB cable
Board side	2 x 4-pin connector (2.0mm)	2 x 4-pin connector (2.0mm)	2 x 8-pin (2x4) connector (2.54mm)	2 x 4-pin (1x4) connector (2.54mm)
Board side pitch	2.54mm	2.00mm	2.54mm	2.54mm
Device side	2 x USB	2 x USB	4 x USB	2 x USB
Bracket	No	No	Yes	Yes
Length	20cm	22cm	30 cm	30 cm

	USB cable			
				
Model Name	CB-USB02A-RS	32000-044300-RS	32000-073400-RS	32000-070301-RS
Cable type	USB cable	USB cable	USB cable	USB cable
Board side	1 x 8-pin (2x4) connector (2.0mm)	1 x 8-pin (2x4) connector (2.54mm)	2 x 5-pin connector (2.0mm) for WAFER-8523, WAFER-945GSE3 only	1 x 8-pin (2x4) connector (2.0mm)
Board side pitch	2.0mm	2.54mm	2.0mm	2.0mm
Device side	2 x USB	2 x USB	2 x USB	2 x USB
Bracket	Yes	No	No	No
Length	30 cm	21 cm	40 cm	21 cm

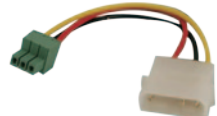

	1394 cable	Keyboard / Mouse cable																			
																					
	<table border="1"> <tr> <td>Pin 1</td> <td>Pin 2</td> <td>Pin 3</td> <td>Pin 4</td> </tr> <tr> <td>+12V</td> <td>GND</td> <td>TPB-</td> <td>TPB+</td> </tr> <tr> <td>Pin 5</td> <td>Pin 6</td> <td>Pin 7</td> <td>Pin 8</td> </tr> <tr> <td>TPA-</td> <td>TPA+</td> <td>SHIELD</td> <td>SHIELD</td> </tr> </table>	Pin 1	Pin 2	Pin 3	Pin 4	+12V	GND	TPB-	TPB+	Pin 5	Pin 6	Pin 7	Pin 8	TPA-	TPA+	SHIELD	SHIELD				
Pin 1	Pin 2	Pin 3	Pin 4																		
+12V	GND	TPB-	TPB+																		
Pin 5	Pin 6	Pin 7	Pin 8																		
TPA-	TPA+	SHIELD	SHIELD																		
Model Name	CB-IEEE1394-RS	19800-000066-RS	19800-000075-RS	32006-000300-100-RS	32000-023800-RS																
Cable type	1394 cable	Keyboard and mouse cable	Y-Cable	Y-Cable	Y-Cable																
Board side	2 x 8-pin (1x8) connector (2.0mm)	2 x 5-pin (1x5) connector (2.54mm)	1 x 6-pin (1x6) connector (2.0mm)	1 x male PS/2	1 x 6-pin (1x6) connector (2.0mm)																
Board side pitch	2.0 mm	2.54mm	2.0mm		2.0mm																
Device side	2 x IEEE1394	2 x Female PS/2	2 x Female PS/2	2 x Female PS/2	2 x Female PS/2																
Bracket	Yes	Yes	Yes	No	No																
Length	21 cm	30 cm	22 cm	12 cm (KB) + 14 (MS)	13 cm																

	Power cable				
					
Model Name	32100-087100-RS	32102-022100-100-RS	32102-005100-200-RS	32100-192900-RS	32100-130300-RS
Cable type	12V power cable	ATX function cable	12V power cable	12V power cable	Power cable for PC/104 CPU module
Board side	1 x 4-pin (2x2) connector	1 x 20-pin ATX power connector	1 x 4-pin (2x2) connector	1 x 4-pin (2x2) connector	1 x 4-pin (1x4) molex
Device side	2 x 4-pin (1x4) molex	1 x 4-pin (1x4) molex 1 x 3-pin PS_ON connector	with lock screw	4-pin 3.5 mm terminal block	3-pin 3.5 mm terminal block
Bracket	No	No	No	No	No
Length	13 cm	30 cm	25cm	25 cm	10 cm

Part numbers listed in the product catalog are for reference purposes. IEI reserves the right to implement substitution parts when the function is not affected.

Cables and Connectors *Audio / LAN / VGA / Adapter Cable*

	Audio cable		
			
Model Name	19800-000111-RS	32007-002600-100-RS	32000-028800-RS
Cable type	Audio cable	Audio cable	Audio cable
Board side	10-pin (2x5) connector (2.0mm)	10-pin (2x5) connector (2.0mm)	12-pin (2x6) connector (2.54mm)
Board side pitch	2.0mm	2.0mm	2.54mm
Device side	3 x Audio jacks	3 x Audio jacks	4 x Audio jacks
Bracket	Yes	No	No
Length	30 cm	30 cm	25 cm

	LAN cable	VGA cable	
			
Model Name	32013-001700-100-RS	32003-000800-100-RS	32000-033804-RS
Cable type	LAN cable	VGA cable	VGA cable
Board side	10-pin (2x5) connector (2.0mm)	10-pin (2x5) connector (2.54mm)	10-pin (2x5) connector (2.0mm)
Board side pitch	2.0mm	2.54mm	2.0mm
Device side	1 x RJ-45	1 x DB15F	1 x DB15F
Bracket	No	No	No
Length	31 cm	30 cm	30 cm

Part numbers listed in the product catalog are for reference purposes. IEI reserves the right to implement substitution parts when the function is not affected.

Rackmount Slide *Chassis optional Accessories*

	SLIDE		
			
Model Name	SLIDE-18	SLIDE-24	EXTENDER-6
Specification	18" rackmount slide	24" rackmount slide	6" extender
Description	For rackmount chassis w/ depth up to 500	For rackmount chassis w/ depth up to 500	For 18" or 24" slider

DIN Rail Kit

	KIT	
		
Model Name	DK-100-R10	DK-84MB
Specification	110(W) X 100(D) mm	168(W) X 96(D) mm
Description	VESA 100 to DIN-Rail kit	DIN mount kit for ECW-281 series, black, RoHS

Mouser Electronics

Authorized Distributor

Click to View Pricing, Inventory, Delivery & Lifecycle Information:

[IEI:](#)

[19800-003600-100-RS](#) [32205-000702-100-RS](#) [32003-000800-100-RS](#) [32000-070301-RS](#) [32100-130300-RS](#) [32801-000201-300-RS](#) [32006-000300-100-RS](#) [32801-000100-300-RS](#) [19800-003500-100-RS](#) [32205-001203-200-RS](#) [32200-025401-RS](#) [32100-087100-RS](#) [19800-000112-RS](#) [32013-001700-100-RS](#) [32200-025001-RS](#) [32100-192900-RS](#) [32205-003800-300-RS](#) [32205-002000-100-RS](#) [19800-004400-200-RS](#) [32000-023800-RS](#) [19800-010900-200-RS](#) [19800-004300-100-RS](#) [32000-033804-RS](#) [19800-000049-RS](#) [32000-073400-RS](#) [32221-001700-100-RS](#) [19800-000100-200-RS](#) [32200-015100-RS](#) [19800-000051-RS](#) [19800-000111-RS](#) [32205-003700-100-RS](#) [32000-080700-RS](#) [32205-002500-100-RS](#) [19800-000066-RS](#) [19800-000075-RS](#) [32225-002000-200-RS](#) [32000-044300-RS](#) [32200-026500-RS](#) [32200-000009-RS](#) [32221-001000-101-RS](#) [19800-000300-100-RS](#)