

NCS2250, NCV2250, NCS2252, NCV2252

Table 1. ORDERING INFORMATION

Automotive	Output	Device (Note 1)	Package	Marking	Shipping †
No	Push-Pull	NCS2250SQ2T2G	SC-88A (SC70-5)	5C	3000 / Tape & Reel
		NCS2250SN2T1G	TSOP-5 (SOT23-5)	5A	3000 / Tape & Reel
	Open Drain	NCS2252SQ2T2G	SC-88A (SC70-5)	5F	3000 / Tape & Reel
		NCS2252SN2T1G	TSOP-5 (SOT23-5)	5D	3000 / Tape & Reel
Yes	Push-Pull	NCV2250SQ2T2G	SC-88A (SC70-5)	5C	3000 / Tape & Reel
		NCV2250SN2T1G	TSOP-5 (SOT23-5)	5A	3000 / Tape & Reel
	Open Drain	NCV2252SQ2T2G	SC-88A (SC70-5)	5F	3000 / Tape & Reel
		NCV2252SN2T1G	TSOP-5 (SOT23-5)	5D	3000 / Tape & Reel

†For information on tape and reel specifications, including part orientation and tape sizes, please refer to our Tape and Reel Packaging Specification Brochure, BRD8011/D.

1. Contact local sales office for more information.

Table 2. PIN DESCRIPTION

Name	Type	Description
V _{DD}	Power	Positive supply pin. Connect to positive rail. A bypass capacitor of at least 0.1 μF is recommended as close as possible to the V _{DD} pin
V _{SS}	Power	Negative supply pin. Connect to ground or negative rail. If not connected to ground, a bypass capacitor of at least 0.1 μF is recommended as close as possible to the V _{SS} pin
OUT	Output	Output pin. NCS2250 has a complementary push-pull output stage. NCS2252 has an open drain output stage which requires an external pull-up resistor
IN-	Input	Inverting input
IN+	Input	Non-inverting input

NCS2250, NCV2250, NCS2252, NCV2252

Table 3. ABSOLUTE MAXIMUM RATINGS (Note 2)

Rating	Symbol	Value	Units
Supply Voltage Range ($V_{DD} - V_{SS}$)	V_S	0 to 6	V
Input Voltage Range	V_{IN}	$V_{SS} - 0.3$ to $V_{DD} + 0.3$	V
Output Voltage Range	V_O	$V_{SS} - 0.3$ to $V_{DD} + 0.3$	V
Output Short Circuit Current (Note 3)	I_{SC}	Continuous	mA
Maximum Junction Temperature (Note 4)	$T_{J(max)}$	+150	°C
Storage Temperature Range	Tstg	-65 to +150	°C
ESD Capability (Note 5)			V
Human Body Model	HBM	2000	
Machine Model	MM	50	
Latch-up Current (Note 6)	I_{LU}	100	mA
Moisture Sensitivity Level (Note 7)	MSL	Level 1	

Stresses exceeding those listed in the Maximum Ratings table may damage the device. If any of these limits are exceeded, device functionality should not be assumed, damage may occur and reliability may be affected.

2. Refer to ELECTRICAL CHARACTERISTICS and APPLICATION INFORMATION for Safe Operating Area.
3. Applies to both single-supply and split-supply operation. Continuous short circuit operation at elevated ambient temperature can result in exceeding the maximum allowed junction temperature of 150°C. Output currents in excess of ±50 mA over long term may adversely affect reliability.
4. See APPLICATION INFORMATION for Safe Operating Area.
5. This device series incorporates ESD protection and is tested by the following methods:
 - ESD Human Body Model tested per JEDEC standard JESD22-A114 (AEC-Q100-002)
 - ESD Machine Model tested per JEDEC standard JESD22-A115 (AEC-Q100-003)
6. Latch-up Current per JEDEC standard JESD78.
7. Moisture Sensitivity Level tested per IPC/JEDEC standard J-ST-020A.

Table 4. THERMAL INFORMATION

Parameter	Symbol	Package	Single Layer Board (Note 8)	Units
Junction-to-Ambient Thermal Resistance	θ_{JA}	TSOP-5 (SOT23-5)	150	°C/W
		SC-88A (SC70-5)	162	

8. Values based on a single layer 1S standard PCB with 1.0 oz copper and a 50 mm² copper area.

Table 5. OPERATING RANGES (Note 9)

Parameter	Symbol	Min	Max	Units
Power Supply Voltage	V_S	1.8	5.5	V
Input Common Mode Voltage Range	V_{CM}	$V_{SS} - 0.2$	$V_{DD} + 0.2$	V
Ambient Temperature	T_A	-40	125	°C

9. See APPLICATION INFORMATION for Safe Operating Area.

NCS2250, NCV2250, NCS2252, NCV2252

Table 6. ELECTRICAL CHARACTERISTICS AT 5 V SUPPLY

Typical values are referenced to $T_A = 25^\circ\text{C}$, $V_{DD} = 5\text{ V}$, $V_{SS} = 0\text{ V}$, $V_{CM} = \text{mid-supply}$, $C_L = 50\text{ pF}$, unless otherwise noted. NCS2252 is connected to $R_{PULL-UP} = 10\text{ k}\Omega$ to V_{DD} , unless otherwise noted. Boldface numbers apply from $T_A = -40^\circ\text{C}$ to 125°C (Notes 10, 11)

Parameter	Test Conditions	Symbol	Min	Typ	Max	Units	
SUPPLY CHARACTERISTICS							
Quiescent Supply Current	No load	I_{DD}		150	200	μA	
					250		
Power Supply Rejection Ratio		PSRR		88		dB	
			62.5				
INPUT CHARACTERISTICS							
Input Offset Voltage		V_{OS}		0.5	6	mV	
					6		
Input Bias Current	(Note 11)	I_{IB}		20		pA	
					1000		
Input Offset Current	(Note 11)	I_{OS}		20		pA	
					1000		
Common Mode Rejection Ratio		CMRR		81		dB	
			59				
Input Capacitance		C_{IN}		3.8		pF	
OUTPUT CHARACTERISTICS							
Output Voltage High	NCS2250, $I_{OUT} = 4\text{ mA}$	V_{OH}		$V_{DD} - 0.1$		V	
			$V_{DD} - 0.3$				
Output Voltage Low	$I_{OUT} = 4\text{ mA}$	V_{OL}		$V_{SS} + 0.09$		V	
					$V_{SS} + 0.3$		
Output Current Capability	NCS2250, Sourcing	I_O		48		mA	
	Sinking			52			
Output Leakage Current	NCS2252, $V_S = 5.5\text{ V}$	I_{LEAK}		1		nA	
Output Rise Time	NCS2250, 10% to 90%, $V_{OD} = 100\text{ mV}$	t_{rise}		4		ns	
Output Fall Time	NCS2250, 90% to 10%, $V_{OD} = 100\text{ mV}$	t_{fall}		4		ns	
	NCS2252, 90% to 10%, $V_{OD} = 100\text{ mV}$			5.5			
Propagation Delay (Note 11)	NCS2250	t_{pLH}, t_{pHL}	$V_{OD} = 100\text{ mV}$		50	64	ns
			$V_{OD} = 50\text{ mV}$		60		
			$V_{OD} = 20\text{ mV}$		90		
	NCS2252 (Note 12)	t_{pHL}	$V_{OD} = 100\text{ mV}$		50	64	ns
			$V_{OD} = 50\text{ mV}$		60		
			$V_{OD} = 20\text{ mV}$		90		
Propagation Delay Skew (NCS2250)	$V_{OD} = 100\text{ mV}, C_L = 50\text{ pF}$	t_{SKEW}		6		ns	
	$V_{OD} = 50\text{ mV}, C_L = 50\text{ pF}$			2			
	$V_{OD} = 20\text{ mV}, C_L = 50\text{ pF}$			1			

10. Refer to ABSOLUTE MAXIMUM RATINGS and APPLICATION INFORMATION for Safe Operating Area.

11. Performance guaranteed over the indicated operating temperature range by design and/or characterization.

12. Typical values are provided for NCS2252 output high-to-low propagation delay. NCS2252 is an open drain comparator. Output low-to-high propagation delay is a function of the RC time constant, which is dependent on the pull-up resistor.

NCS2250, NCV2250, NCS2252, NCV2252

Table 7. ELECTRICAL CHARACTERISTICS AT 1.8 V SUPPLY

Typical values are referenced to $T_A = 25^\circ\text{C}$, $V_{DD} = 1.8\text{ V}$, $V_{SS} = 0\text{ V}$, $V_{CM} = \text{mid-supply}$, $C_L = 50\text{ pF}$, unless otherwise noted. NCS2252 is connected to $R_{PULL-UP} = 10\text{ k}\Omega$ to V_{DD} , unless otherwise noted. Boldface numbers apply from $T_A = -40^\circ\text{C}$ to 125°C (Notes 13, 14)

Parameter	Test Conditions	Symbol	Min	Typ	Max	Units	
SUPPLY CHARACTERISTICS							
Quiescent Supply Current	No load	I_{DD}		145	200	μA	
					250		
Power Supply Rejection Ratio		PSRR		82		dB	
			62.5				
INPUT CHARACTERISTICS							
Input Offset Voltage		V_{OS}		0.5	6	mV	
					6		
Input Bias Current	(Note 14)	I_{IB}		20		pA	
					1000		
Input Offset Current	(Note 14)	I_{OS}		20		pA	
					1000		
Common Mode Rejection Ratio		CMRR		76		dB	
			55				
Input Capacitance		C_{IN}		4.4		pF	
OUTPUT CHARACTERISTICS							
Output Voltage High	NCS2250, $I_{OUT} = 4\text{ mA}$	V_{OH}		$V_{DD} - 0.14$		V	
			$V_{DD} - 0.3$				
Output Voltage Low	$I_{OUT} = 4\text{ mA}$	V_{OL}		$V_{SS} + 0.12$		V	
					$V_{SS} + 0.3$		
Output Current Capability	NCS2250, Sourcing	I_O		25		mA	
	Sinking			42			
Output Leakage Current	NCS2252, $V_S = 5.5\text{ V}$	I_{LEAK}		1		nA	
Output Rise Time	NCS2250, 10% to 90%, $V_{OD} = 100\text{ mV}$	t_{rise}		7		ns	
Output Fall Time	NCS2250, 90% to 10%, $V_{OD} = 100\text{ mV}$	t_{fall}		6		ns	
	NCS2252, 90% to 10%, $V_{OD} = 100\text{ mV}$			7			
Propagation Delay (Note 14)	NCS2250	t_{pLH}, t_{pHL}	$V_{OD} = 100\text{ mV}$		56	68	ns
			$V_{OD} = 50\text{ mV}$		71		
			$V_{OD} = 20\text{ mV}$		106		
	NCS2252 (Note 15)	t_{pHL}	$V_{OD} = 100\text{ mV}$		56	68	ns
			$V_{OD} = 50\text{ mV}$		71		
			$V_{OD} = 20\text{ mV}$		106		
Propagation Delay Skew (NCS2250)	$V_{OD} = 100\text{ mV}, C_L = 50\text{ pF}$	t_{SKEW}		5		ns	
	$V_{OD} = 50\text{ mV}, C_L = 50\text{ pF}$			2			
	$V_{OD} = 20\text{ mV}, C_L = 50\text{ pF}$			1			

13. Refer to ABSOLUTE MAXIMUM RATINGS and APPLICATION INFORMATION for Safe Operating Area.

14. Performance guaranteed over the indicated operating temperature range by design and/or characterization.

15. Typical values are provided for NCS2252 output high-to-low propagation delay. NCS2252 is an open drain comparator.

Output low-to-high propagation delay is a function of the RC time constant, which is dependent on the pull-up resistor.

GRAPHS

Typical performance at $T_A = 25^\circ\text{C}$, unless otherwise noted.

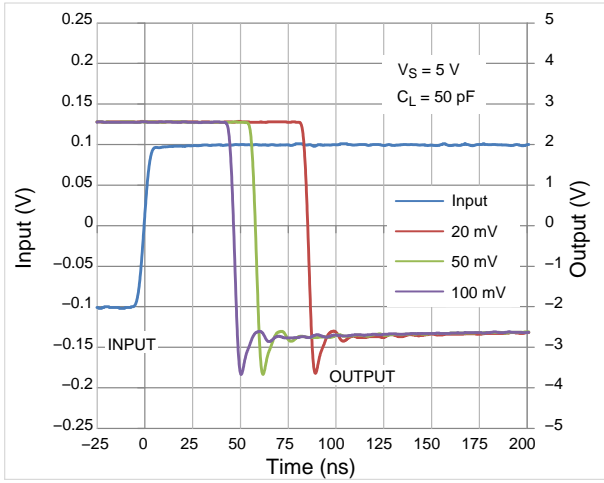

Figure 1. Transient Response at 5 V Supply with Varying Input Overdrive Voltages

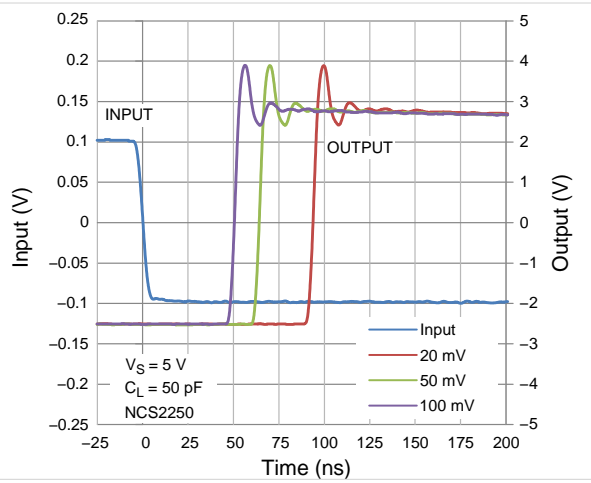

Figure 2. Transient Response at 5 V Supply with Varying Input Overdrive Voltages

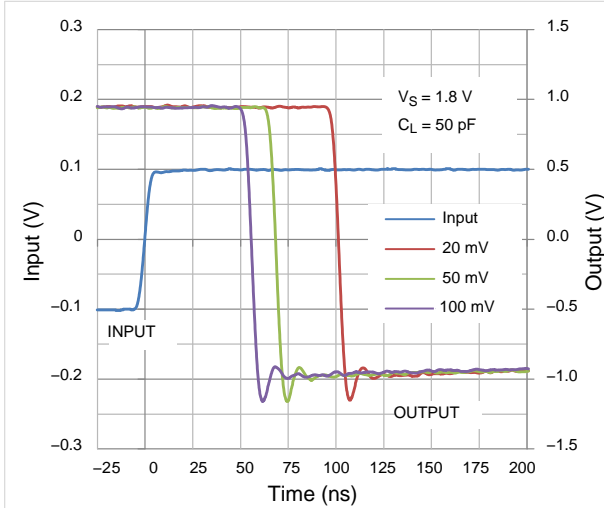

Figure 3. Transient Response at 1.8 V Supply with Varying Input Overdrive Voltages

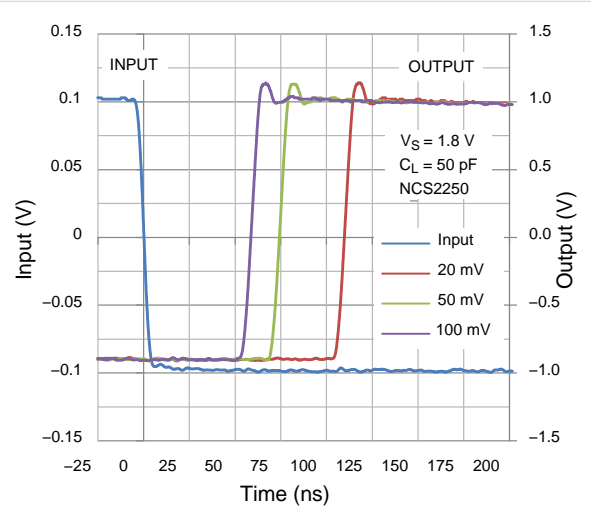

Figure 4. Transient Response at 1.8 V Supply with Varying Input Overdrive Voltages

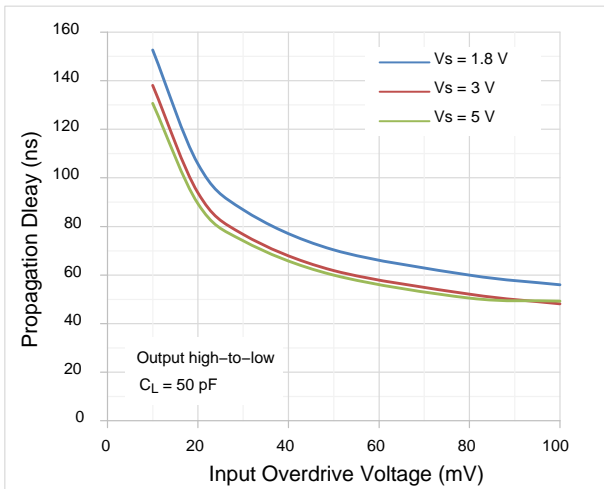

Figure 5. Output High-to-Low Propagation Delay vs. Input Overdrive Voltage

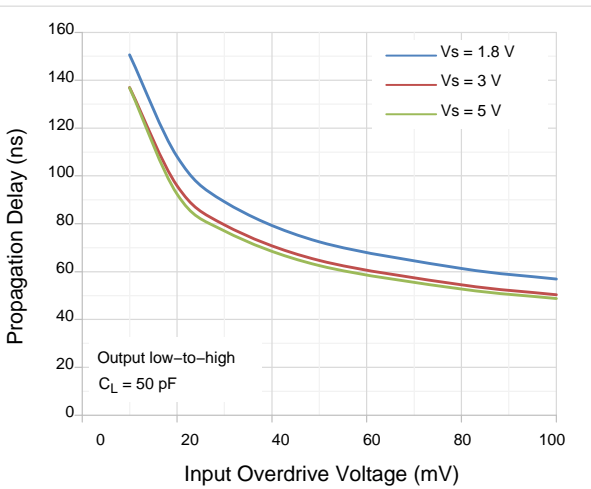

Figure 6. Output Low-to-High Propagation Delay vs. Input Overdrive Voltage

NCS2250, NCV2250, NCS2252, NCV2252

GRAPHS (continued)

Typical performance at $T_A = 25^\circ\text{C}$, unless otherwise noted.

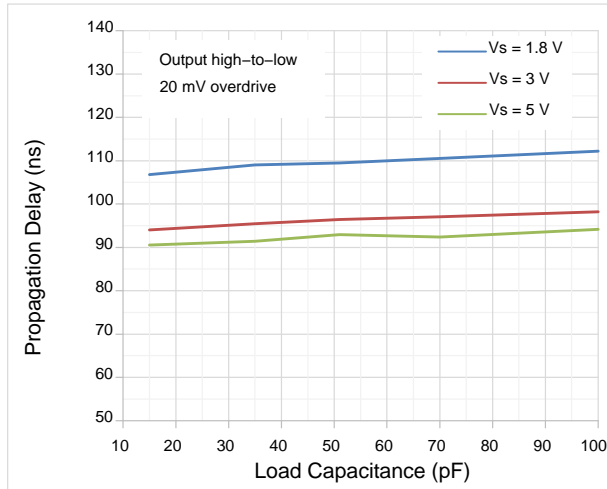

Figure 7. Output High-to-Low Propagation Delay vs. Load Capacitance

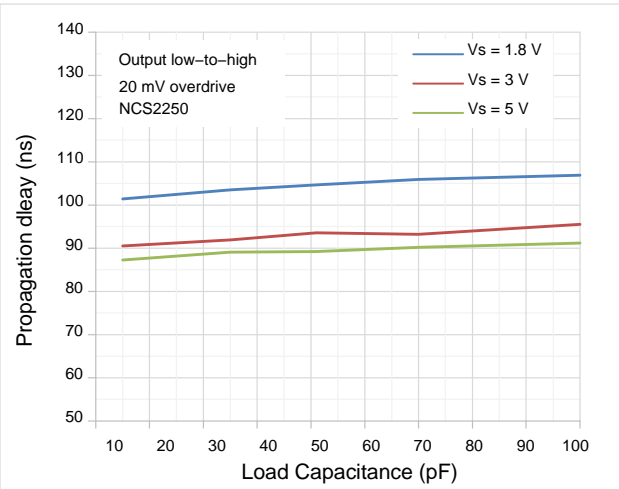

Figure 8. Output Low-to-High Propagation Delay vs. Load Capacitance

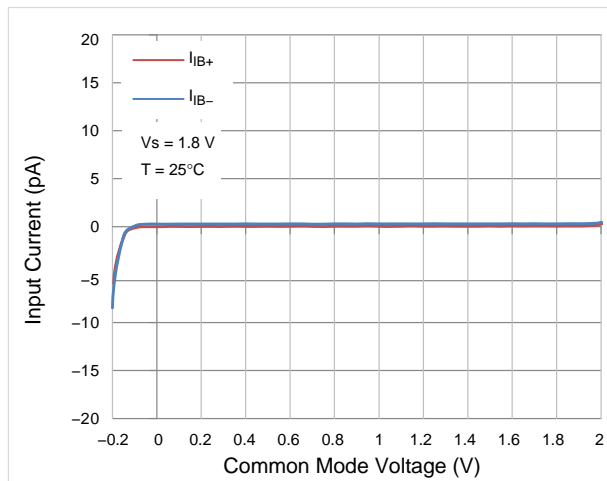

Figure 9. Input Current vs. Common Mode Voltage at 1.8 V Supply

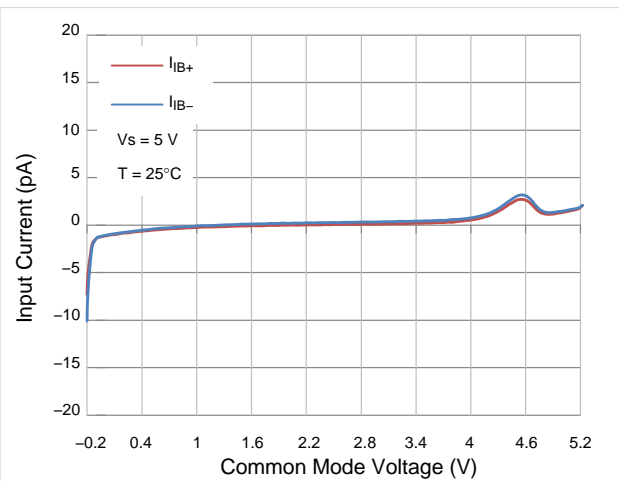

Figure 10. Input Current vs. Common Mode Voltage at 5 V Supply

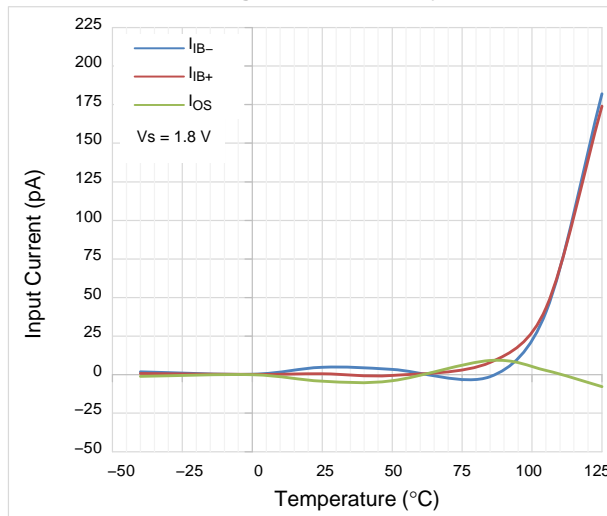

Figure 11. Input Current vs. Temperature at 1.8 V Supply

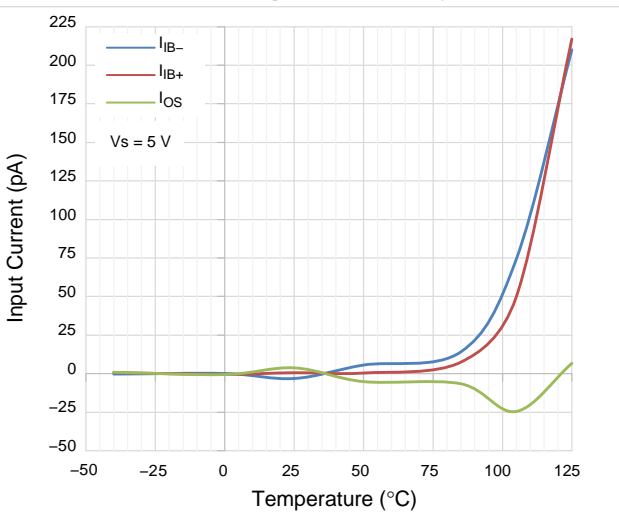

Figure 12. Input Current vs. Temperature at 5 V Supply

NCS2250, NCV2250, NCS2252, NCV2252

GRAPHS (continued)

Typical performance at $T_A = 25^\circ\text{C}$, unless otherwise noted.

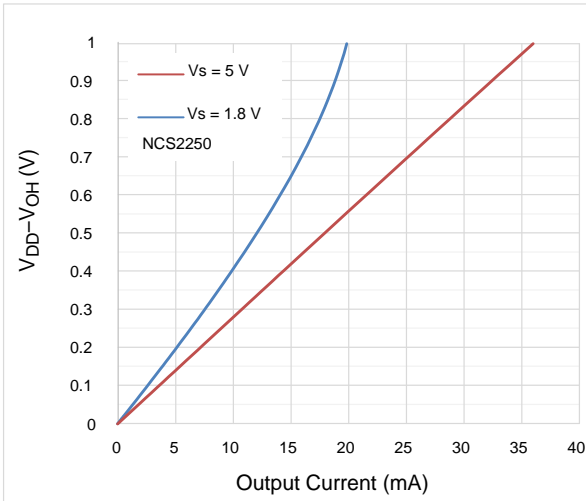

Figure 13. Output Voltage High (Relative to V_{DD}) vs. Output Current

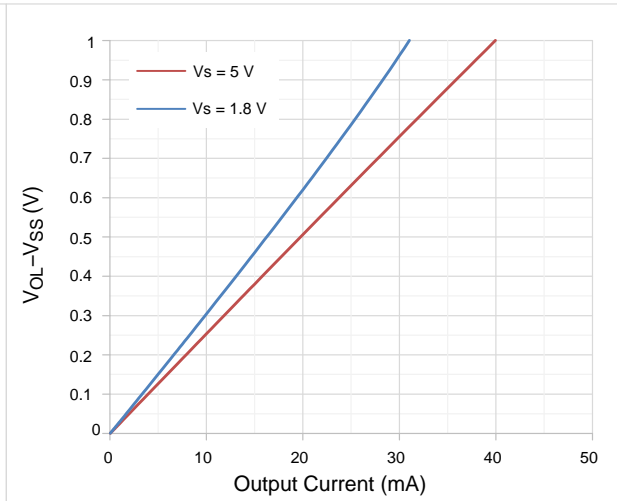

Figure 14. Output Voltage Low (Relative to V_{SS}) vs. Output Current

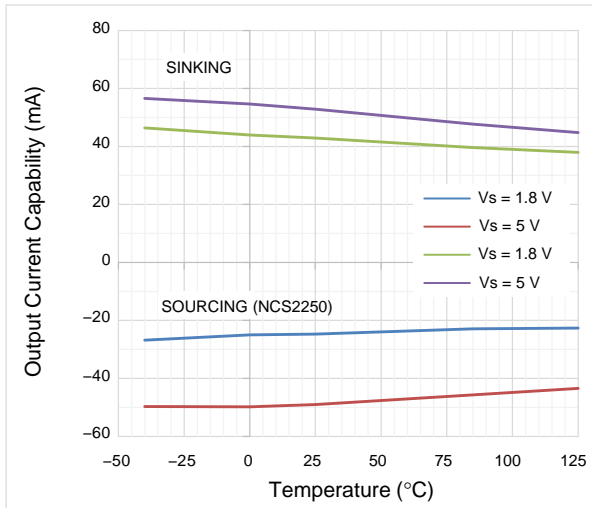

Figure 15. Output Current Capability vs. Temperature

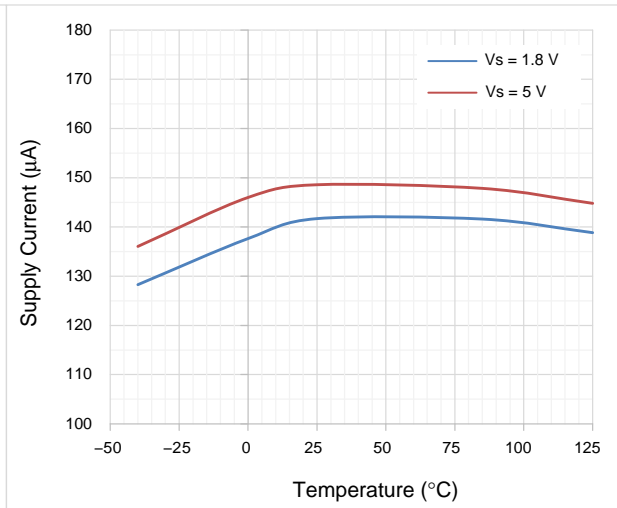

Figure 16. Supply Current vs. Temperature

APPLICATION INFORMATION

Input Stage

The NCS2250 and NCS2252 have rail-to-rail inputs. The input common mode voltage range of these comparators extend 200 mV beyond the rails, allowing voltage sensing at ground or at the supply voltage.

Output Stage

The NCS2250 has a complementary, push-pull output stage. When the output transitions between high and low states, a low resistance path is created between the positive and negative supply rails, temporarily increasing the supply current during the transition.

The NCS2252 has an open-drain output stage. This allows the output to be connected through a pull-up resistor to another supply voltage for applications where level translation or level shifting is needed. The output resistor can be connected to voltages below V_{DD} or up to $V_{DD} + 0.3$ V. Since the NCS2252 relies on an external pull-up resistor

to provide sourcing current, the timing of the output low-to-high transition is determined by the RC time constant of the pull-up resistor and the load capacitance.

Hysteresis

When the inputs are near the same voltage, slight voltage fluctuations due to noise can cause the output to oscillate between high and low states. If noise-induced switching behavior is observed at the output, hysteresis should be added through an external resistor network. This is particularly the case for NCS2250, as sustained output oscillations causing increased supply current will result in elevated junction temperature.

Hysteresis can be added to the circuit by adding one or two external resistors depending on whether an inverting or non-inverting configuration is needed. Figure 17 shows the inverting configuration. In this configuration, the output voltage adjusts the threshold at the IN+ pin.

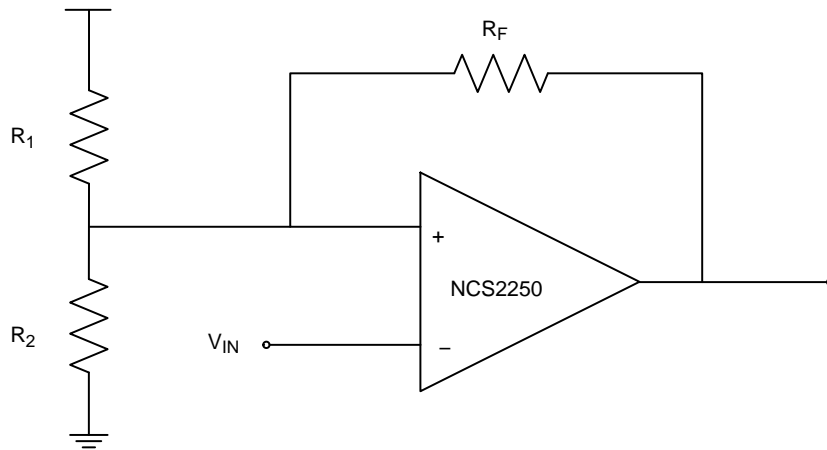

Figure 17. Comparator with Hysteresis, Inverting Configuration

For the inverting configuration, the value of the high-level input voltage which triggers the output to switch from high to low is given by the following equation:

$$V_{IN_high} = \frac{R_1 \times R_F}{R_1 \times R_F + R_1 \times R_2 + R_2 \times R_F} \times V_{DD} \quad (\text{eq. 1})$$

The value of the low-level input voltage which triggers the output to switch from low to high is given by the following equation:

$$V_{IN_low} = \frac{R_1 \times R_F + R_1 \times R_2}{R_1 \times R_F + R_1 \times R_2 + R_2 \times R_F} \times V_{DD} \quad (\text{eq. 2})$$

Figure 18 shows the non-inverting configuration. For the non-inverting configuration, the threshold V_{th} set by R_1 and R_2 is fixed. The output adjusts the input signal on IN+.

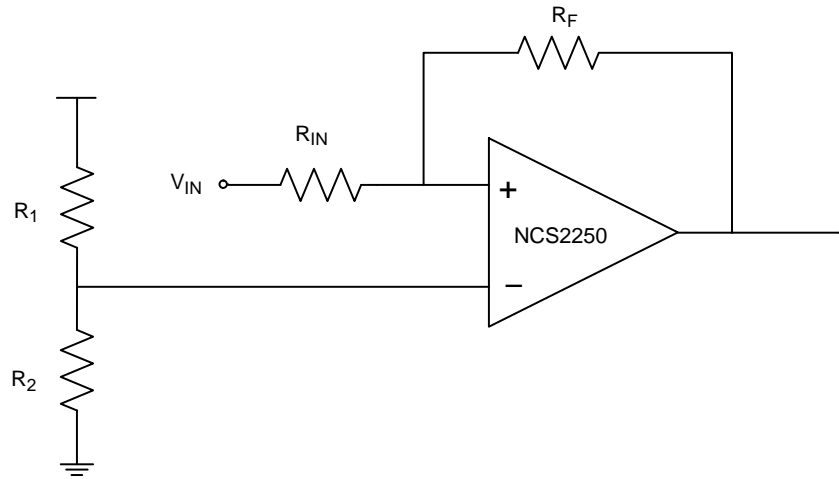

Figure 18. Comparator with Hysteresis, Non-Inverting Configuration

The value of the high-level input voltage which triggers the output to switch from low to high is given by the following equation:

$$V_{IN_high} = \frac{V_{th} \times (R_{IN} + R_F)}{R_F} \quad (\text{eq. 3})$$

The value of the low-level input voltage which triggers the output to switch from high to low is given by the following equation:

$$V_{IN_low} = \frac{V_{th} \times (R_{IN} + R_F) - R_{IN} \times V_{DD}}{R_F} \quad (\text{eq. 4})$$

Power dissipation

The absolute maximum junction temperature is 150°C. The junction temperature can be calculated using the power dissipation P , thermal resistance θ_{JA} , and ambient temperature T_A .

$$T_J = \theta_{JA} \times P + T_A \quad (\text{eq. 5})$$

Layout Techniques

High speed layout techniques are recommended for the best performance.

Bypass capacitors of at least 0.1 μ F must be placed as close as possible to supply pins.

The traces on the input pins should be short to minimize any noise on the high impedance inputs. In general, shorter traces will reduce parasitic capacitance, inductance, and resistance.

Identify and keep sensitive traces away from possible noise sources such as clocks. Crosstalk can be reduced by increasing the distance between traces. Do not let traces run parallel for long distances. Take advantage of routing layers to separate traces that would otherwise run parallel. Ground or DC voltage supplies can be used to separate a sensitive trace from a noise source.

Avoid floating nodes as these will pick up noise.

MECHANICAL CASE OUTLINE

PACKAGE DIMENSIONS

ON Semiconductor®



SCALE 2:1

SC-88A (SC-70-5/SOT-353)
CASE 419A-02
ISSUE L

DATE 17 JAN 2013

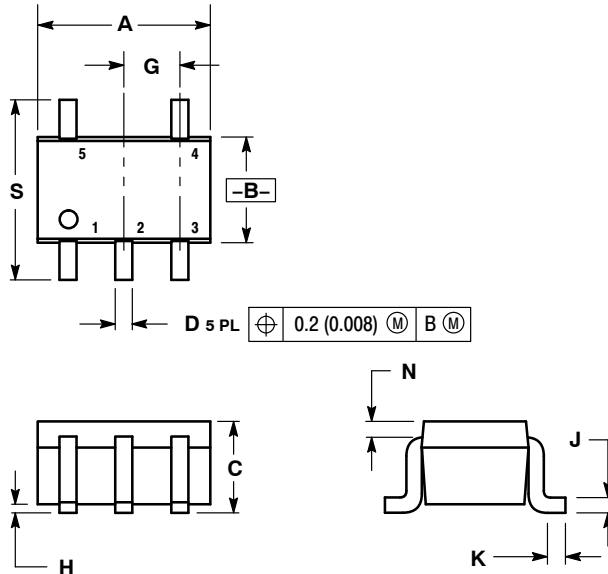

SOLDER FOOTPRINT

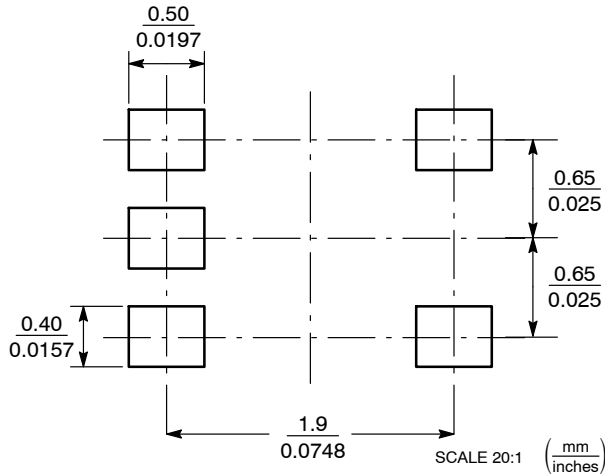

NOTES:

1. DIMENSIONING AND TOLERANCING PER ANSI Y14.5M, 1982.
2. CONTROLLING DIMENSION: INCH.
3. 419A-01 OBSOLETE. NEW STANDARD 419A-02.
4. DIMENSIONS A AND B DO NOT INCLUDE MOLD FLASH, PROTRUSIONS, OR GATE BURRS.

DIM	INCHES		MILLIMETERS	
	MIN	MAX	MIN	MAX
A	0.071	0.087	1.80	2.20
B	0.045	0.053	1.15	1.35
C	0.031	0.043	0.80	1.10
D	0.004	0.012	0.10	0.30
G	0.026 BSC		0.65 BSC	
H	---	0.004	---	0.10
J	0.004	0.010	0.10	0.25
K	0.004	0.012	0.10	0.30
N	0.008 REF		0.20 REF	
S	0.079	0.087	2.00	2.20

GENERIC MARKING DIAGRAM*

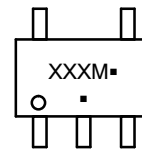

- XXX = Specific Device Code
- M = Date Code
- = Pb-Free Package

(Note: Microdot may be in either location)

*This information is generic. Please refer to device data sheet for actual part marking. Pb-Free indicator, "G" or microdot "▪", may or may not be present. Some products may not follow the Generic Marking.

- | | | | | |
|--|--|--|--|--|
| <p>STYLE 1:
PIN 1. BASE
2. EMITTER
3. BASE
4. COLLECTOR
5. COLLECTOR</p> | <p>STYLE 2:
PIN 1. ANODE
2. EMITTER
3. BASE
4. COLLECTOR
5. CATHODE</p> | <p>STYLE 3:
PIN 1. ANODE 1
2. N/C
3. ANODE 2
4. CATHODE 2
5. CATHODE 1</p> | <p>STYLE 4:
PIN 1. SOURCE 1
2. DRAIN 1/2
3. SOURCE 1
4. GATE 1
5. GATE 2</p> | <p>STYLE 5:
PIN 1. CATHODE
2. COMMON ANODE
3. CATHODE 2
4. CATHODE 3
5. CATHODE 4</p> |
| <p>STYLE 6:
PIN 1. EMITTER 2
2. BASE 2
3. EMITTER 1
4. COLLECTOR
5. COLLECTOR 2/BASE 1</p> | <p>STYLE 7:
PIN 1. BASE
2. EMITTER
3. BASE
4. COLLECTOR
5. COLLECTOR</p> | <p>STYLE 8:
PIN 1. CATHODE
2. COLLECTOR
3. N/C
4. BASE
5. EMITTER</p> | <p>STYLE 9:
PIN 1. ANODE
2. CATHODE
3. ANODE
4. ANODE
5. ANODE</p> | <p>Note: Please refer to datasheet for style callout. If style type is not called out in the datasheet refer to the device datasheet pinout or pin assignment.</p> |

DOCUMENT NUMBER:	98ASB42984B	Electronic versions are uncontrolled except when accessed directly from the Document Repository. Printed versions are uncontrolled except when stamped "CONTROLLED COPY" in red.
DESCRIPTION:	SC-88A (SC-70-5/SOT-353)	PAGE 1 OF 1

ON Semiconductor and ON are trademarks of Semiconductor Components Industries, LLC dba ON Semiconductor or its subsidiaries in the United States and/or other countries. ON Semiconductor reserves the right to make changes without further notice to any products herein. ON Semiconductor makes no warranty, representation or guarantee regarding the suitability of its products for any particular purpose, nor does ON Semiconductor assume any liability arising out of the application or use of any product or circuit, and specifically disclaims any and all liability, including without limitation special, consequential or incidental damages. ON Semiconductor does not convey any license under its patent rights nor the rights of others.

MECHANICAL CASE OUTLINE

PACKAGE DIMENSIONS

ON Semiconductor®



SCALE 2:1

TSOP-5 CASE 483 ISSUE N

DATE 12 AUG 2020

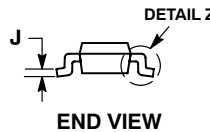
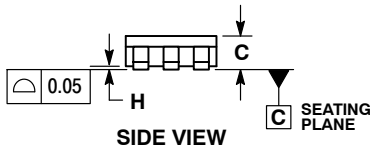
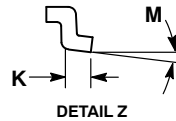
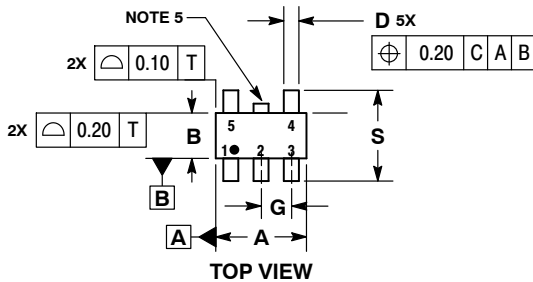

NOTES:

1. DIMENSIONING AND TOLERANCING PER ASME Y14.5M, 1994.
2. CONTROLLING DIMENSION: MILLIMETERS.
3. MAXIMUM LEAD THICKNESS INCLUDES LEAD FINISH THICKNESS. MINIMUM LEAD THICKNESS IS THE MINIMUM THICKNESS OF BASE MATERIAL.
4. DIMENSIONS A AND B DO NOT INCLUDE MOLD FLASH, PROTRUSIONS, OR GATE BURRS. MOLD FLASH, PROTRUSIONS, OR GATE BURRS SHALL NOT EXCEED 0.15 PER SIDE. DIMENSION A.
5. OPTIONAL CONSTRUCTION: AN ADDITIONAL TRIMMED LEAD IS ALLOWED IN THIS LOCATION. TRIMMED LEAD NOT TO EXTEND MORE THAN 0.2 FROM BODY.

DIM	MILLIMETERS	
	MIN	MAX
A	2.85	3.15
B	1.35	1.65
C	0.90	1.10
D	0.25	0.50
G	0.95 BSC	
H	0.01	0.10
J	0.10	0.26
K	0.20	0.60
M	0°	10°
S	2.50	3.00

SOLDERING FOOTPRINT*

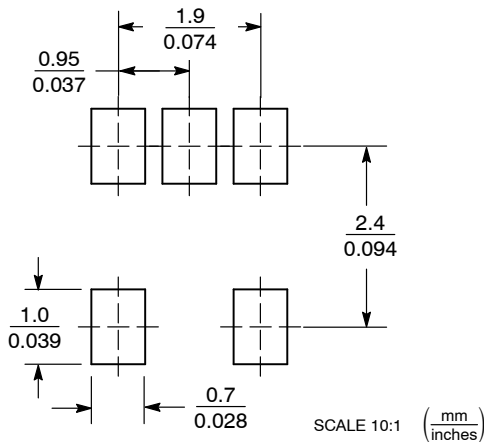

*For additional information on our Pb-Free strategy and soldering details, please download the ON Semiconductor Soldering and Mounting Techniques Reference Manual, SOLDERRM/D.

GENERIC MARKING DIAGRAM*

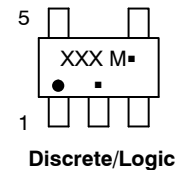
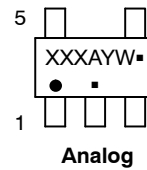

- XXX = Specific Device Code
 A = Assembly Location
 Y = Year
 W = Work Week
 ■ = Pb-Free Package
- XXX = Specific Device Code
 M = Date Code
 ■ = Pb-Free Package

(Note: Microdot may be in either location)

*This information is generic. Please refer to device data sheet for actual part marking. Pb-Free indicator, "G" or microdot "■", may or may not be present.

DOCUMENT NUMBER:	98ARB18753C	Electronic versions are uncontrolled except when accessed directly from the Document Repository. Printed versions are uncontrolled except when stamped "CONTROLLED COPY" in red.
DESCRIPTION:	TSOP-5	PAGE 1 OF 1

ON Semiconductor and ON are trademarks of Semiconductor Components Industries, LLC dba ON Semiconductor or its subsidiaries in the United States and/or other countries. ON Semiconductor reserves the right to make changes without further notice to any products herein. ON Semiconductor makes no warranty, representation or guarantee regarding the suitability of its products for any particular purpose, nor does ON Semiconductor assume any liability arising out of the application or use of any product or circuit, and specifically disclaims any and all liability, including without limitation special, consequential or incidental damages. ON Semiconductor does not convey any license under its patent rights nor the rights of others.

onsemi, **Onsemi**, and other names, marks, and brands are registered and/or common law trademarks of Semiconductor Components Industries, LLC dba "**onsemi**" or its affiliates and/or subsidiaries in the United States and/or other countries. **onsemi** owns the rights to a number of patents, trademarks, copyrights, trade secrets, and other intellectual property. A listing of **onsemi**'s product/patent coverage may be accessed at www.onsemi.com/site/pdf/Patent-Marking.pdf. **onsemi** reserves the right to make changes at any time to any products or information herein, without notice. The information herein is provided "as-is" and **onsemi** makes no warranty, representation or guarantee regarding the accuracy of the information, product features, availability, functionality, or suitability of its products for any particular purpose, nor does **onsemi** assume any liability arising out of the application or use of any product or circuit, and specifically disclaims any and all liability, including without limitation special, consequential or incidental damages. Buyer is responsible for its products and applications using **onsemi** products, including compliance with all laws, regulations and safety requirements or standards, regardless of any support or applications information provided by **onsemi**. "Typical" parameters which may be provided in **onsemi** data sheets and/or specifications can and do vary in different applications and actual performance may vary over time. All operating parameters, including "Typicals" must be validated for each customer application by customer's technical experts. **onsemi** does not convey any license under any of its intellectual property rights nor the rights of others. **onsemi** products are not designed, intended, or authorized for use as a critical component in life support systems or any FDA Class 3 medical devices or medical devices with a same or similar classification in a foreign jurisdiction or any devices intended for implantation in the human body. Should Buyer purchase or use **onsemi** products for any such unintended or unauthorized application, Buyer shall indemnify and hold **onsemi** and its officers, employees, subsidiaries, affiliates, and distributors harmless against all claims, costs, damages, and expenses, and reasonable attorney fees arising out of, directly or indirectly, any claim of personal injury or death associated with such unintended or unauthorized use, even if such claim alleges that **onsemi** was negligent regarding the design or manufacture of the part. **onsemi** is an Equal Opportunity/Affirmative Action Employer. This literature is subject to all applicable copyright laws and is not for resale in any manner.

PUBLICATION ORDERING INFORMATION

LITERATURE FULFILLMENT:

Email Requests to: orderlit@onsemi.com

onsemi Website: www.onsemi.com

TECHNICAL SUPPORT

North American Technical Support:

Voice Mail: 1 800-282-9855 Toll Free USA/Canada

Phone: 011 421 33 790 2910

Europe, Middle East and Africa Technical Support:

Phone: 00421 33 790 2910

For additional information, please contact your local Sales Representative

Mouser Electronics

Authorized Distributor

Click to View Pricing, Inventory, Delivery & Lifecycle Information:

[onsemi:](#)

[NCV2250SN2T3G](#) [NCS2250SN2T3G](#)