

## Pin Configuration

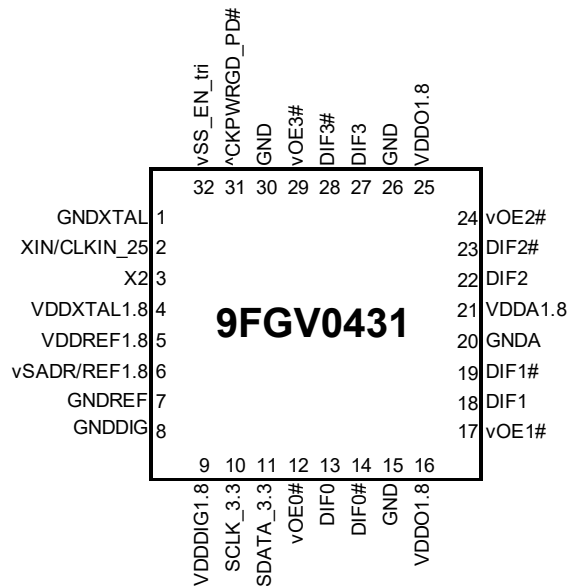

### 32-pin MLF, 5x5 mm, 0.5mm pitch

^ prefix indicates internal 120KOhm pull up resistor  
v prefix indicates internal 120KOhm pull down resistor

## SMBus Address Selection Table

	SADR	Address	+ Read/Write Bit
State of SADR on first application of CKPWRGD_PD#	0	1101000	x
	1	1101010	x

## Power Management Table

CKPWRGD_PD#	SMBus OE bit	DIFx			REF
		OEx#	True O/P	Comp. O/P	
0	X	X	Low	Low	Hi-Z <sup>1</sup>
1	1	0	Running	Running	Running
1	0	1	Low	Low	Low

1. REF is Hi-Z until the 1st assertion of CKPWRGD\_PD# high. After this, when CKPWRGD\_PD# is low, REF is Low.

## Power Connections

Pin Number	VDD	GND	Description
4	1		XTAL Analog
5		7	REF Output
9		8, 30	Digital Power
16, 25		15, 26	DIF outputs
21		20	PLL Analog

## Pin Descriptions

Pin#	Pin Name	Type	Pin Description
1	GNDXTAL	GND	GND for XTAL
2	XIN/CLKIN_25	IN	Crystal input or Reference Clock input. Nominally 25MHz.
3	X2	OUT	Crystal output.
4	VDDXTAL1.8	PWR	Power supply for XTAL, nominal 1.8V
5	VDDREF1.8	PWR	VDD for REF output. nominal 1.8V.
6	vSADR/REF1.8	LATCHED I/O	Latch to select SMBus Address/1.8V LVCMOS copy of X1 pin.
7	GNDREF	GND	Ground pin for the REF outputs.
8	GNDDIG	GND	Ground pin for digital circuitry
9	VDDDIG1.8	PWR	1.8V digital power (dirty power)
10	SCLK_3.3	IN	Clock pin of SMBus circuitry, 3.3V tolerant.
11	SDATA_3.3	I/O	Data pin for SMBus circuitry, 3.3V tolerant.
12	vOE0#	IN	Active low input for enabling DIF pair 0. This pin has an internal pull-down. 1 =disable outputs, 0 = enable outputs
13	DIF0	OUT	Differential true clock output
14	DIF0#	OUT	Differential Complementary clock output
15	GND	GND	Ground pin.
16	VDDO1.8	PWR	Power supply for outputs, nominally 1.8V.
17	vOE1#	IN	Active low input for enabling DIF pair 1. This pin has an internal pull-down. 1 =disable outputs, 0 = enable outputs
18	DIF1	OUT	Differential true clock output
19	DIF1#	OUT	Differential Complementary clock output
20	GNDA	GND	Ground pin for the PLL core.
21	VDDA1.8	PWR	1.8V power for the PLL core.
22	DIF2	OUT	Differential true clock output
23	DIF2#	OUT	Differential Complementary clock output
24	vOE2#	IN	Active low input for enabling DIF pair 2. This pin has an internal pull-down. 1 =disable outputs, 0 = enable outputs
25	VDDO1.8	PWR	Power supply for outputs, nominally 1.8V.
26	GND	GND	Ground pin.
27	DIF3	OUT	Differential true clock output
28	DIF3#	OUT	Differential Complementary clock output
29	vOE3#	IN	Active low input for enabling DIF pair 3. This pin has an internal pull-down. 1 =disable outputs, 0 = enable outputs
30	GND	GND	Ground pin.
31	^CKPWRGD_PD#	IN	Input notifies device to sample latched inputs and start up on first high assertion. Low enters Power Down Mode, subsequent high assertions exit Power Down Mode. This pin has internal pull-up resistor.
32	vSS_EN_tri	LATCHED IN	Latched select input to select spread spectrum amount at initial power up : 1 = -0.5% spread, M = -0.25%, 0 = Spread Off

### Test Loads

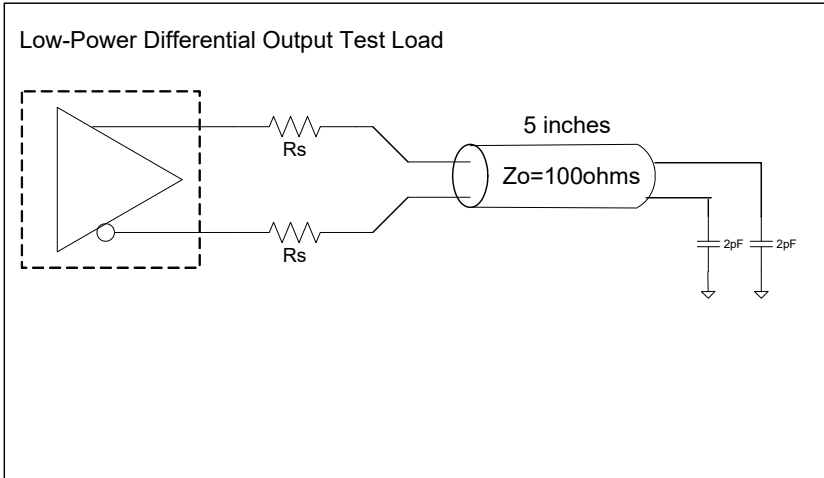

#### Alternate Differential Output Terminations

Rs	Zo	Units
33	100	Ohms
27	85	

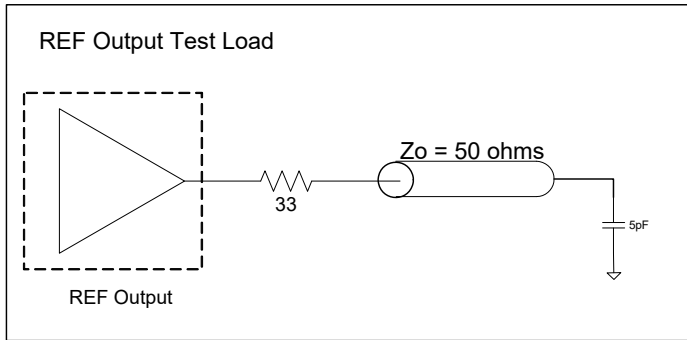

### Alternate Terminations

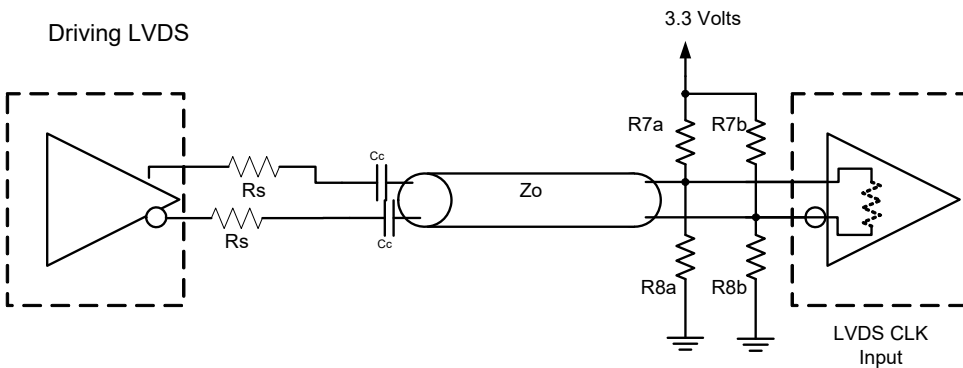

#### Driving LVDS inputs with the 9FGV0431

Component	Value		Note
	Receiver has termination	Receiver does not have termination	
R7a, R7b	10K ohm	140 ohm	
R8a, R8b	5.6K ohm	75 ohm	
Cc	0.1 uF	0.1 uF	
Vcm	1.2 volts	1.2 volts	

## Absolute Maximum Ratings

Stresses above the ratings listed below can cause permanent damage to the 9FGV0431. These ratings, which are standard values for IDT commercially rated parts, are stress ratings only. Functional operation of the device at these or any other conditions above those indicated in the operational sections of the specifications is not implied. Exposure to absolute maximum rating conditions for extended periods can affect product reliability. Electrical parameters are guaranteed only over the recommended operating temperature range.

PARAMETER	SYMBOL	CONDITIONS	MIN	TYP	MAX	UNITS	NOTES
1.8V Supply Voltage	VDDx1.8	Applies to All VDD pins	-0.5		2.5	V	1,2
Input Voltage	V <sub>IN</sub>		-0.5		V <sub>DD</sub> +0.3V	V	1, 3
Input High Voltage, SMBus	V <sub>IHSMB</sub>	SMBus clock and data pins			3.6V	V	1
Storage Temperature	T <sub>s</sub>		-65		150	°C	1
Junction Temperature	T <sub>j</sub>				125	°C	1
Input ESD protection	ESD prot	Human Body Model	2000			V	1

<sup>1</sup>Guaranteed by design and characterization, not 100% tested in production.

<sup>2</sup>Operation under these conditions is neither implied nor guaranteed.

<sup>3</sup>Not to exceed 2.5V.

## Electrical Characteristics—Current Consumption

TA = T<sub>COM</sub> or T<sub>IND</sub>; Supply Voltage per VDD of normal operation conditions, See Test Loads for Loading Conditions

PARAMETER	SYMBOL	CONDITIONS	MIN	TYP	MAX	UNITS	NOTES
Operating Supply Current	I <sub>DDAOP</sub>	VDDA, All outputs active @100MHz		6	8	mA	1
	I <sub>DDOP</sub>	VDD, All outputs active @100MHz		26	30	mA	1
Suspend Supply Current	I <sub>DD SUSP</sub>	VDDxxx, PD# = 0, Wake-On-LAN enabled		6	8	mA	1
Powerdown Current	I <sub>DDPD</sub>	PD#=0		0.6	1	mA	1, 2

<sup>1</sup>Guaranteed by design and characterization, not 100% tested in production.

<sup>2</sup>Assuming REF is not running in power down state

## Electrical Characteristics—Output Duty Cycle, Jitter, and Skew Characteristics

TA = T<sub>COM</sub> or T<sub>IND</sub>; Supply Voltage per VDD of normal operation conditions, See Test Loads for Loading Conditions

PARAMETER	SYMBOL	CONDITIONS	MIN	TYP	MAX	UNITS	NOTES
Duty Cycle	t <sub>DC</sub>	Measured differentially, PLL Mode	45	50.1	55	%	1
Skew, Output to Output	t <sub>sk3</sub>	V <sub>T</sub> = 50%		37	50	ps	1
Jitter, Cycle to cycle	t <sub>j cyc-cyc</sub>	PLL mode		12	50	ps	1,2

<sup>1</sup>Guaranteed by design and characterization, not 100% tested in production.

<sup>2</sup> Measured from differential waveform

## Electrical Characteristics–Input/Supply/Common Parameters–Normal Operating Conditions

TA = T<sub>COM</sub> or T<sub>IND</sub>; Supply Voltage per VDD of normal operation conditions, See Test Loads for Loading Conditions

PARAMETER	SYMBOL	CONDITIONS	MIN	TYP	MAX	UNITS	NOTES
1.8V Supply Voltage	VDD <sub>x1.8</sub>	Supply voltage for core, analog and single-ended LVCMOS outputs	1.7	1.8	1.9	V	1
Ambient Operating Temperature	T <sub>COM</sub>	Commercial range	0	25	70	°C	1
	T <sub>IND</sub>	Industrial range	-40	25	85	°C	1
Input High Voltage	V <sub>IH</sub>	Single-ended inputs, except SMBus	0.75 V <sub>DD</sub>		V <sub>DD</sub> + 0.3	V	1
Input Mid Voltage	V <sub>IM</sub>	Single-ended tri-level inputs ('_tri' suffix, if present)	0.4 V <sub>DD</sub>		0.6 V <sub>DD</sub>	V	1
Input Low Voltage	V <sub>IL</sub>	Single-ended inputs, except SMBus	-0.3		0.25 V <sub>DD</sub>	V	1
Schmitt Trigger Positive Going Threshold Voltage	V <sub>T+</sub>	Single-ended inputs, where indicated	0.4 V <sub>DD</sub>		0.7 V <sub>DD</sub>	V	1
Schmitt Trigger Negative Going Threshold Voltage	V <sub>T-</sub>	Single-ended inputs, where indicated	0.1 V <sub>DD</sub>		0.4 V <sub>DD</sub>	V	1
Hysteresis Voltage	V <sub>H</sub>	V <sub>T+</sub> - V <sub>T-</sub>	0.1 V <sub>DD</sub>		0.4 V <sub>DD</sub>	V	1
Output High Voltage	V <sub>IH</sub>	Single-ended outputs, except SMBus. I <sub>OH</sub> = -2mA	V <sub>DD</sub> -0.45			V	1
Output Low Voltage	V <sub>IL</sub>	Single-ended outputs, except SMBus. I <sub>OL</sub> = -2mA			0.45	V	1
Input Current	I <sub>IN</sub>	Single-ended inputs, V <sub>IN</sub> = GND, V <sub>IN</sub> = VDD	-5		5	uA	1
	I <sub>INP</sub>	Single-ended inputs V <sub>IN</sub> = 0 V; Inputs with internal pull-up resistors V <sub>IN</sub> = VDD; Inputs with internal pull-down resistors	-20		20	uA	1
Input Frequency	F <sub>in</sub>	XTAL, or X1 input	23	25	27	MHz	1
Pin Inductance	L <sub>pin</sub>				7	nH	1
Capacitance	C <sub>IN</sub>	Logic Inputs, except DIF_IN	1.5		5	pF	1
	C <sub>OUT</sub>	Output pin capacitance			6	pF	1
Clk Stabilization	T <sub>STAB</sub>	From V <sub>DD</sub> Power-Up and after input clock stabilization or de-assertion of PD# to 1st clock		0.6	1.8	ms	1,2
SS Modulation Frequency	f <sub>MOD</sub>	Allowable Frequency (Triangular Modulation)	31	31.6	32	kHz	1
OE# Latency	t <sub>LATOE#</sub>	DIF start after OE# assertion DIF stop after OE# deassertion	1	2	3	clocks	1,3
Tdrive_PD#	t <sub>DRVPD</sub>	DIF output enable after PD# de-assertion			300	us	1,3
Tfall	t <sub>F</sub>	Fall time of single-ended control inputs			5	ns	1,2
Trise	t <sub>R</sub>	Rise time of single-ended control inputs			5	ns	1,2
SMBus Input Low Voltage	V <sub>ILSMB</sub>	V <sub>DD</sub> SMB = 3.3V, see note 4 for V <sub>DD</sub> SMB < 3.3V			0.8	V	1,4
SMBus Input High Voltage	V <sub>IHSMB</sub>	V <sub>DD</sub> SMB = 3.3V, see note 5 for V <sub>DD</sub> SMB < 3.3V	2.1		3.6	V	1,5
SMBus Output Low Voltage	V <sub>OLSMB</sub>	@ I <sub>PULLUP</sub>			0.4	V	1
SMBus Sink Current	I <sub>PULLUP</sub>	@ V <sub>OL</sub>	4			mA	1
Nominal Bus Voltage	V <sub>DD</sub> SMB		1.7		3.6	V	1
SCLK/SDATA Rise Time	t <sub>RSMB</sub>	(Max VIL - 0.15) to (Min VIH + 0.15)			1000	ns	1
SCLK/SDATA Fall Time	t <sub>FSMB</sub>	(Min VIH + 0.15) to (Max VIL - 0.15)			300	ns	1
SMBus Operating Frequency	f <sub>MAXSMB</sub>	Maximum SMBus operating frequency			400	kHz	1

<sup>1</sup> Guaranteed by design and characterization, not 100% tested in production.

<sup>2</sup> Control input must be monotonic from 20% to 80% of input swing.

<sup>3</sup> Time from deassertion until outputs are > 200mV.

<sup>4</sup> For V<sub>DD</sub>SMB < 3.3V, V<sub>ILSMB</sub> <= 0.35V<sub>DD</sub>SMB.

<sup>5</sup> For V<sub>DD</sub>SMB < 3.3V, V<sub>IHSMB</sub> >= 0.65V<sub>DD</sub>SMB.

## Electrical Characteristics–DIF 0.7V Low Power HCSL Output

TA = T<sub>COM</sub> or T<sub>IND</sub>; Supply Voltage per VDD of normal operation conditions, See Test Loads for Loading Conditions

PARAMETER	SYMBOL	CONDITIONS	MIN	TYP	MAX	UNITS	NOTES
Slew rate	Trf	Scope averaging on 3.0V/ns setting	2.6	3.5	4.6	V/ns	1, 2, 3
		Scope averaging on 2.0V/ns setting	1.5	2.5	3.5	V/ns	1, 2, 3
Slew rate matching	ΔTrf	Slew rate matching, Scope averaging on		8	20	%	1,2,4
Voltage High	V <sub>HIGH</sub>	Statistical measurement on single-ended signal using oscilloscope math function. (Scope averaging on)	660	797	850	mV	1,8
Voltage Low	V <sub>LOW</sub>		-150	15	150		1
Max Voltage	V <sub>max</sub>	Measurement on single ended signal using absolute value. (Scope averaging off)		833	1150	mV	1
Min Voltage	V <sub>min</sub>		-300	-41			1
Vswing	Vswing	Scope averaging off	300	1564		mV	1,2
Crossing Voltage (abs)	V <sub>cross_abs</sub>	Scope averaging off	300	427	550	mV	1,5
Crossing Voltage (var)	Δ-V <sub>cross</sub>	Scope averaging off		15	140	mV	1,6

<sup>1</sup>Guaranteed by design and characterization, not 100% tested in production. C<sub>L</sub> = 2pF with R<sub>S</sub> = 33Ω for Zo = 50Ω (100Ω differential trace impedance).

<sup>2</sup> Measured from differential waveform

<sup>3</sup> Slew rate is measured through the Vswing voltage range centered around differential 0V. This results in a +/-150mV window around differential 0V.

<sup>4</sup> Matching applies to rising edge rate for Clock and falling edge rate for Clock#. It is measured using a +/-75mV window centered on the average cross point where Clock rising meets Clock# falling. The median cross point is used to calculate the voltage thresholds the oscilloscope is to use for the edge rate calculations.

<sup>5</sup> V<sub>cross</sub> is defined as voltage where Clock = Clock# measured on a component test board and only applies to the differential rising edge (i.e. Clock rising and Clock# falling).

<sup>6</sup> The total variation of all V<sub>cross</sub> measurements in any particular system. Note that this is a subset of V<sub>cross\_min/max</sub> (V<sub>cross</sub> absolute) allowed. The intent is to limit V<sub>cross</sub> induced modulation by setting Δ-V<sub>cross</sub> to be smaller than V<sub>cross</sub> absolute.

<sup>7</sup> At default SMBus settings.

## Electrical Characteristics–Filtered Phase Jitter Parameters - PCIe Common Clocked (CC) Architectures

T<sub>AMB</sub> = over the specified operating range. Supply Voltages per normal operation conditions, See Test Loads for Loading Conditions

SYMBOL	PARAMETER	CONDITIONS	MIN	TYP	MAX	Specification Limit	UNITS	NOTES
t <sub>jphPCIEG1-CC</sub>	Phase Jitter, PLL Mode	PCIe Gen 1	21	25	35	86	ps (p-p)	1, 2, 3
t <sub>jphPCIEG2-CC</sub>		PCIe Gen 2 Low Band 10kHz < f < 1.5MHz (PLL BW of 5-16MHz, 8-16MHz, CDR = 5MHz)	0.9	0.9	1.1	3	ps (rms)	1, 2
		PCIe Gen 2 High Band 1.5MHz < f < Nyquist (50MHz) (PLL BW of 5-16MHz, 8-16MHz, CDR = 5MHz)	1.5	1.6	1.9	3.1	ps (rms)	1, 2
t <sub>jphPCIEG3-CC</sub>		PCIe Gen 3 (PLL BW of 2-4MHz, 2-5MHz, CDR = 10MHz)	0.3	0.37	0.44	1	ps (rms)	1, 2
t <sub>jphPCIEG4-CC</sub>		PCIe Gen 4 (PLL BW of 2-4MHz, 2-5MHz, CDR = 10MHz)	0.3	0.37	0.44	0.5	ps (rms)	1, 2

### Notes on PCIe Filtered Phase Jitter Table.

<sup>1</sup> Applies to all differential outputs, guaranteed by design and characterization.

<sup>2</sup> Calculated from Intel-supplied Clock Jitter Tool, with spread on and off.

<sup>3</sup> Sample size of at least 100K cycles. This figure extrapolates to 108ps pk-pk at 1M cycles for a BER of 1<sup>-12</sup>.

## Electrical Characteristics–REF

TA = T<sub>COM</sub> or T<sub>IND</sub>; Supply Voltage per VDD of normal operation conditions, See Test Loads for Loading Conditions

PARAMETER	SYMBOL	CONDITIONS	MIN	TYP	MAX	UNITS	Notes
Long Accuracy	ppm	see T <sub>period</sub> min-max values		0		ppm	1,2
Clock period	T <sub>period</sub>	25 MHz output nominal		40		ns	1,2
Rise/Fall Slew Rate	t <sub>rf1</sub>	V <sub>OH</sub> = VDD-0.45V, V <sub>OL</sub> = 0.45V	0.5	1.3	2.5	V/ns	1,3
Duty Cycle	d <sub>ted</sub>	V <sub>T</sub> = VDD/2 V	45	53	55	%	1,4
Duty Cycle Distortion	d <sub>t1</sub>	V <sub>T</sub> = VDD/2 V	0	2	3	%	1,5
Jitter, cycle to cycle	t <sub>jcy-cyc</sub>	V <sub>T</sub> = VDD/2 V		20	250	ps	1,4
Noise floor	t <sub>dBc1k</sub>	1kHz offset		-125	-119	dBc	1,4
Noise floor	t <sub>dBc10k</sub>	10kHz offset to Nyquist		-140	-120	dBc	1,4
Jitter, phase	t <sub>jphREF</sub>	12kHz to 5MHz		0.81	1.5	ps (rms)	1,4

<sup>1</sup>Guaranteed by design and characterization, not 100% tested in production.

<sup>2</sup>All Long Term Accuracy and Clock Period specifications are guaranteed assuming that REF is trimmed to 25.00 MHz

<sup>3</sup>Typical value occurs when REF slew rate is set to default value

<sup>4</sup>When driven by a crystal.

<sup>5</sup>When driven by an external oscillator via the X1 pin. X2 should be floating in this case.

## Clock Periods–Differential Outputs with Spread Spectrum Disabled

SSC OFF	Center Freq. MHz	Measurement Window							Units	Notes
		1 Clock	1us	0.1s	0.1s	0.1s	1us	1 Clock		
		-c2c jitter AbsPer Min	-SSC Short-Term Average Min	- ppm Long-Term Average Min	0 ppm Period Nominal	+ ppm Long-Term Average Max	+SSC Short-Term Average Max	+c2c jitter AbsPer Max		
DIF	100.00	9.94900		9.99900	10.00000	10.00100		10.05100	ns	1,2

## Clock Periods–Differential Outputs with -0.5% Spread Spectrum Enabled

SSC ON	Center Freq. MHz	Measurement Window							Units	Notes
		1 Clock	1us	0.1s	0.1s	0.1s	1us	1 Clock		
		-c2c jitter AbsPer Min	-SSC Short-Term Average Min	- ppm Long-Term Average Min	0 ppm Period Nominal	+ ppm Long-Term Average Max	+SSC Short-Term Average Max	+c2c jitter AbsPer Max		
DIF	99.75	9.94906	9.99906	10.02406	10.02506	10.02607	10.05107	10.10107	ns	1,2

<sup>1</sup>Guaranteed by design and characterization, not 100% tested in production.

<sup>2</sup>All Long Term Accuracy and Clock Period specifications are guaranteed assuming that REF is trimmed to 25.00 MHz

## General SMBus Serial Interface Information

### How to Write

- Controller (host) sends a start bit
- Controller (host) sends the write address
- IDT clock will **acknowledge**
- Controller (host) sends the beginning byte location = N
- IDT clock will **acknowledge**
- Controller (host) sends the byte count = X
- IDT clock will **acknowledge**
- Controller (host) starts sending Byte N through Byte N+X-1
- IDT clock will **acknowledge** each byte **one at a time**
- Controller (host) sends a Stop bit

Index Block Write Operation		
Controller (Host)		IDT (Slave/Receiver)
T	starT bit	
Slave Address		
WR	WRite	
Beginning Byte = N		ACK
		ACK
Data Byte Count = X		ACK
Beginning Byte N		ACK
O	X Byte	O
O		O
O		O
Byte N + X - 1		ACK
P	stoP bit	

**Note:** Read/Write address is latched on SADR pin.

### How to Read

- Controller (host) will send a start bit
- Controller (host) sends the write address
- IDT clock will **acknowledge**
- Controller (host) sends the beginning byte location = N
- IDT clock will **acknowledge**
- Controller (host) will send a separate start bit
- Controller (host) sends the read address
- IDT clock will **acknowledge**
- IDT clock will send the data byte count = X
- IDT clock sends Byte N+X-1
- IDT clock sends **Byte 0 through Byte X (if X<sub>(H)</sub> was written to Byte 8)**
- Controller (host) will need to acknowledge each byte
- Controller (host) will send a not acknowledge bit
- Controller (host) will send a stop bit

Index Block Read Operation		
Controller (Host)		IDT (Slave/Receiver)
T	starT bit	
Slave Address		
WR	WRite	
Beginning Byte = N		ACK
		ACK
RT	Repeat starT	
Slave Address		
RD	ReaD	
		ACK
ACK		Data Byte Count=X
		Beginning Byte N
O	X Byte	O
O		O
O		O
O		O
		Byte N + X - 1
N	Not acknowledge	
P	stoP bit	



**SMBus Table: Output Enable Register**

Byte 0	Name	Control Function	Type	0	1	Default
Bit 7		Reserved				1
Bit 6		Reserved				1
Bit 5		Reserved				1
Bit 4		Reserved				1
Bit 3	DIF OE3	Output Enable	RW	Low/Low	Enabled	1
Bit 2	DIF OE3	Output Enable	RW	Low/Low	Enabled	1
Bit 1	DIF OE2	Output Enable	RW	Low/Low	Enabled	1
Bit 0	DIF OE1	Output Enable	RW	Low/Low	Enabled	1

**SMBus Table: SS Readback and Vhigh Control Register**

Byte 1	Name	Control Function	Type	0	1	Default
Bit 7	SSENRB1	SS Enable Readback Bit1	R	00' for SS_EN_tri = 0, '01' for SS_EN_tri = 'M', '11 for SS_EN_tri = '1'		Latch
Bit 6	SSENRB1	SS Enable Readback Bit0	R			Latch
Bit 5	SSEN_SWCNTRL	Enable SW control of SS	RW	SS control locked	Values in B1[4:3] control SS amount.	0
Bit 4	SSENSW1	SS Enable Software Ctl Bit1	RW <sup>1</sup>	00' = SS Off, '01' = -0.25% SS,		0
Bit 3	SSENSW0	SS Enable Software Ctl Bit0	RW <sup>1</sup>	'10' = Reserved, '11' = -0.5% SS		0
Bit 2		Reserved				1
Bit 1	AMPLITUDE 1	Controls Output Amplitude	RW	00 = 0.6V	01 = 0.7V	1
Bit 0	AMPLITUDE 0		RW	10 = 0.8V	11 = 0.9V	0

1. B1[5] must be set to a 1 for these bits to have any effect on the part.

**SMBus Table: DIF Slew Rate Control Register**

Byte 2	Name	Control Function	Type	0	1	Default
Bit 7		Reserved				1
Bit 6		Reserved				1
Bit 5		Reserved				1
Bit 4		Reserved				1
Bit 3	SLEWRATESEL DIF3	Adjust Slew Rate of DIF3	RW	2.0V/ns	3.0V/ns	1
Bit 2	SLEWRATESEL DIF2	Adjust Slew Rate of DIF2	RW	2.0V/ns	3.0V/ns	1
Bit 1	SLEWRATESEL DIF1	Adjust Slew Rate of DIF3	RW	2.0V/ns	3.0V/ns	1
Bit 0	SLEWRATESEL DIF0	Adjust Slew Rate of DIF1	RW	2.0V/ns	3.0V/ns	1

**SMBus Table: REF Control Register**

Byte 3	Name	Control Function	Type	0	1	Default
Bit 7	REF	Slew Rate Control	RW	00 = 0.9V/ns	01 = 1.3V/ns	0
Bit 6			RW	10 = 1.6V/ns	11 = 1.8V/ns	1
Bit 5	REF Power Down Function	Wake-on-Lan Enable for REF	RW	REF does not run in Power Down	REF runs in Power Down	0
Bit 4	REF OE	REF Output Enable	RW	Low	Enabled	1
Bit 3		Reserved				1
Bit 2		Reserved				1
Bit 1		Reserved				1
Bit 0		Reserved				1

Byte 4 is reserved and reads back 'hFF'.

**SMBus Table: Revision and Vendor ID Register**

Byte 5	Name	Control Function	Type	0	1	Default
Bit 7	RID3	Revision ID	R	A rev = 0000		0
Bit 6	RID2		R			0
Bit 5	RID1		R			0
Bit 4	RID0		R			0
Bit 3	VID3	VENDOR ID	R	0001 = IDT		0
Bit 2	VID2		R			0
Bit 1	VID1		R			0
Bit 0	VID0		R			1

**SMBus Table: Device Type/Device ID**

Byte 6	Name	Control Function	Type	0	1	Default
Bit 7	Device Type1	Device Type	R	00 = FGV, 01 = DBV, 10 = DMV, 11= Reserved		0
Bit 6	Device Type0		R			0
Bit 5	Device ID5	Device ID	R	000100 binary or 04 hex		0
Bit 4	Device ID4		R			0
Bit 3	Device ID3		R			0
Bit 2	Device ID2		R			1
Bit 1	Device ID1		R			0
Bit 0	Device ID0		R			0

**SMBus Table: Byte Count Register**

Byte 7	Name	Control Function	Type	0	1	Default
Bit 7		Reserved				0
Bit 6		Reserved				0
Bit 5		Reserved				0
Bit 4	BC4	Byte Count Programming	RW	Writing to this register will configure how many bytes will be read back, default is = 8 bytes.		0
Bit 3	BC3		RW			1
Bit 2	BC2		RW			0
Bit 1	BC1		RW			0
Bit 0	BC0		RW			0

## Recommended Crystal Characteristics (3225 package)

PARAMETER	VALUE	UNITS	NOTES
Frequency	25	MHz	1
Resonance Mode	Fundamental	-	1
Frequency Tolerance @ 25°C	±20	PPM Max	1
Frequency Stability, ref @ 25°C Over Operating Temperature Range	±20	PPM Max	1
Temperature Range (commercial)	0~70	°C	1
Temperature Range (industrial)	-40~85	°C	2
Equivalent Series Resistance (ESR)	50	Ω Max	1
Shunt Capacitance (C <sub>0</sub> )	7	pF Max	1
Load Capacitance (C <sub>L</sub> )	8	pF Max	1
Drive Level	0.3	mW Max	1
Aging per year	±5	PPM Max	1

**Notes:**

1. FOX 603-25-150.
2. For I-temp, FOX 603-25-261.

### Thermal Characteristics

PARAMETER	SYMBOL	CONDITIONS	PKG	TYP.	UNITS	NOTES
Thermal Resistance	$\theta_{JC}$	Junction to Case	NLG32	42	°C/W	1
	$\theta_{Jb}$	Junction to Base		2.4	°C/W	1
	$\theta_{JA0}$	Junction to Air, still air		39	°C/W	1
	$\theta_{JA1}$	Junction to Air, 1 m/s air flow		33	°C/W	1
	$\theta_{JA3}$	Junction to Air, 3 m/s air flow		28	°C/W	1
	$\theta_{JA5}$	Junction to Air, 5 m/s air flow		27	°C/W	1

<sup>1</sup>ePad soldered to board

### Marking Diagrams

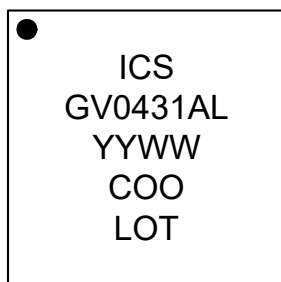
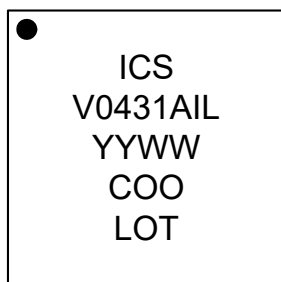

Notes:

1. Line 2 is the truncated part number.
2. 'L' denotes RoHS compliant package.
3. 'I' denotes industrial temperature grade.
4. 'YYWW' is the last two digits of the year and week that the part was assembled.
5. 'COO' denotes country of origin.
6. 'LOT' is the lot number.

Package Outline and Dimensions (NLG32)

REVISIONS		
REV	DESCRIPTION	DATE
00	INITIAL RELEASE	11/23/15
01	MODIFY DIMENSION TABLE	11/30/15

DIMENSION	
SYMBOL	MIN NOM MAX
b	0.18 0.25 0.30
D	5.00 BSC
E	5.00 BSC
D2	3.00 3.10 3.20
E2	3.00 3.10 3.20
L	0.50 0.40 0.50
e	0.50 BSC
A	0.80 0.90 1.00
A1	0.00 0.02 0.05
A3	0.2 REF
k	0.55

INDEX AREA

BOTTOM VIEW

SIDE VIEW

TOP VIEW

PIN #1 ID OPTION

NOTE :

- ALL DIMENSION ARE IN mm. ANGLES IN DEGREES.
- COPPLANARITY APPLIES TO THE EXPOSED PAD AS WELL AS THE TERMINALS.
- WARRIAGE SHALL NOT EXCEED 0.08 mm.
- WARRIAGE SHALL NOT EXCEED 0.10 mm.

TOLERANCES UNLESS SPECIFIED	
DECIMAL	ANGULAR
X ± .1	± 1°
XX ± .05	
XXX ± .030	

APPROVALS	DATE
DRAWN: 24C	11/23/15
CHECKED	

6024 Silver Creek Valley Rd San Jose, CA 95138 PHONE: (408) 284-8200 FAX: (408) 284-3572	
<b>IDT</b> www.IDT.com	
TITLE NL/NLG 32 PACKAGE OUTLINE	
5.0 x 5.0 mm BODY, EPAD 3.10 mm SQ	
0.50 mm PITCH QFN.	
SIZE	DRAWING NO.
C	PSC-4171-03
REV	
01	
DO NOT SCALE DRAWING	
SHEET 1 OF 2	

Package Outline and Dimensions (NLG32), cont.

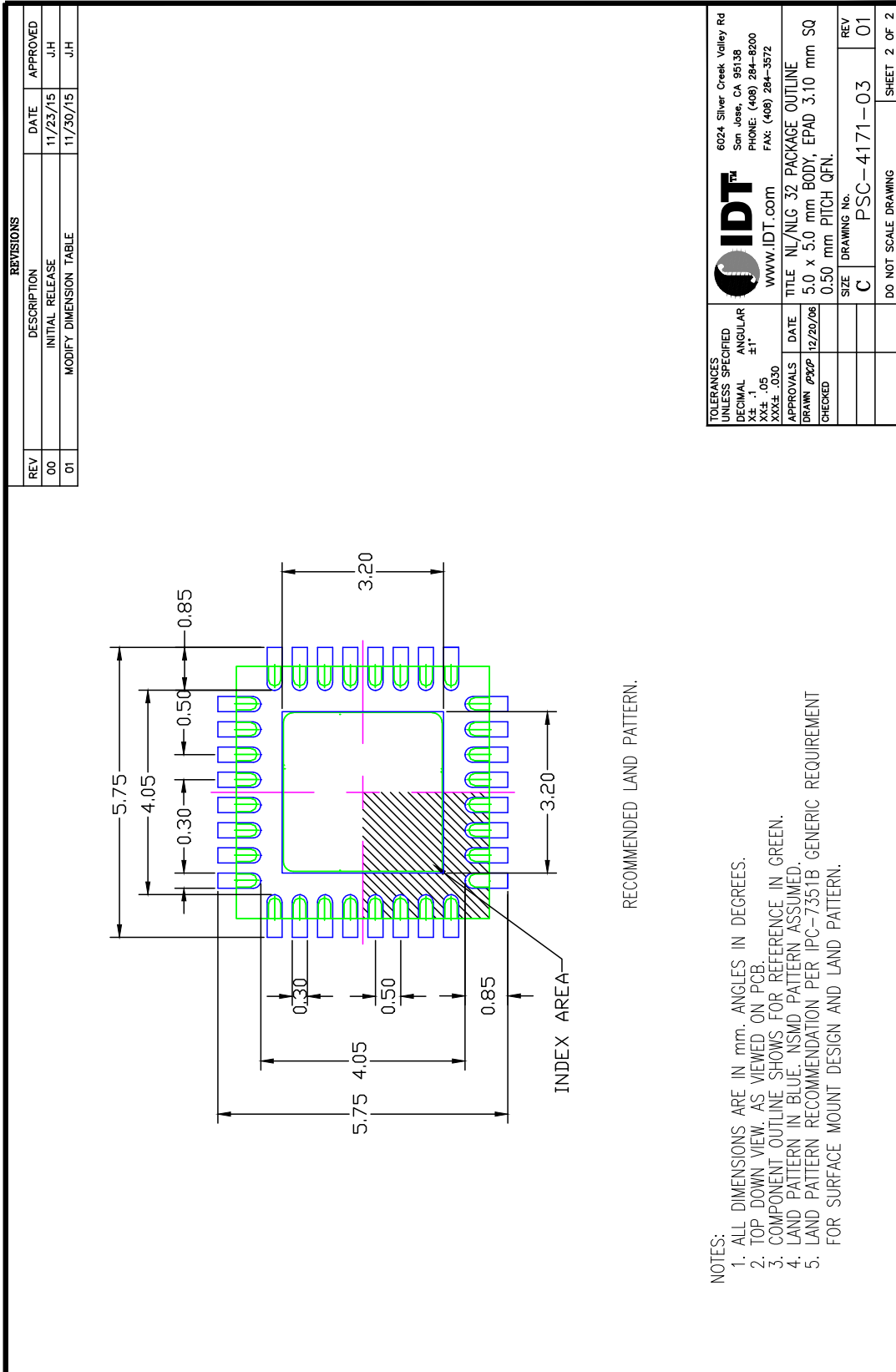

## Ordering Information

Part / Order Number	Shipping Packaging	Package	Temperature
9FGV0431AKLF	Trays	32-pin MLF	0 to +70° C
9FGV0431AKLFT	Tape and Reel	32-pin MLF	0 to +70° C
9FGV0431AKILF	Trays	32-pin MLF	-40 to +85° C
9FGV0431AKILFT	Tape and Reel	32-pin MLF	-40 to +85° C

“LF” suffix to the part number are the Pb-Free configuration and are RoHS compliant.

“A” is the device revision designator (will not correlate with the datasheet revision).

## Revision History

Issue Date	Description
October 18, 2016	Removed IDT crystal part number
June 22, 2017	Updated front page Gendes to reflect the PCIe Gen4 updates. Updated Electrical Characteristics - Filtered Phase Jitter Parameters - PCIe Common Clocked (CC) Architectures and added PCIe Gen4 Data
June 6, 2019	Updated Input Current minimum and maximum values from -200/200uA to -20/20uA.



## IMPORTANT NOTICE AND DISCLAIMER

RENESAS ELECTRONICS CORPORATION AND ITS SUBSIDIARIES (“RENESAS”) PROVIDES TECHNICAL SPECIFICATIONS AND RELIABILITY DATA (INCLUDING DATASHEETS), DESIGN RESOURCES (INCLUDING REFERENCE DESIGNS), APPLICATION OR OTHER DESIGN ADVICE, WEB TOOLS, SAFETY INFORMATION, AND OTHER RESOURCES “AS IS” AND WITH ALL FAULTS, AND DISCLAIMS ALL WARRANTIES, EXPRESS OR IMPLIED, INCLUDING, WITHOUT LIMITATION, ANY IMPLIED WARRANTIES OF MERCHANTABILITY, FITNESS FOR A PARTICULAR PURPOSE, OR NON-INFRINGEMENT OF THIRD PARTY INTELLECTUAL PROPERTY RIGHTS.

These resources are intended for developers skilled in the art designing with Renesas products. You are solely responsible for (1) selecting the appropriate products for your application, (2) designing, validating, and testing your application, and (3) ensuring your application meets applicable standards, and any other safety, security, or other requirements. These resources are subject to change without notice. Renesas grants you permission to use these resources only for development of an application that uses Renesas products. Other reproduction or use of these resources is strictly prohibited. No license is granted to any other Renesas intellectual property or to any third party intellectual property. Renesas disclaims responsibility for, and you will fully indemnify Renesas and its representatives against, any claims, damages, costs, losses, or liabilities arising out of your use of these resources. Renesas' products are provided only subject to Renesas' Terms and Conditions of Sale or other applicable terms agreed to in writing. No use of any Renesas resources expands or otherwise alters any applicable warranties or warranty disclaimers for these products.

(Rev.1.0 Mar 2020)

### Corporate Headquarters

TOYOSU FORESIA, 3-2-24 Toyosu,  
Koto-ku, Tokyo 135-0061, Japan  
[www.renesas.com](http://www.renesas.com)

### Contact Information

For further information on a product, technology, the most up-to-date version of a document, or your nearest sales office, please visit:  
[www.renesas.com/contact/](http://www.renesas.com/contact/)

### Trademarks

Renesas and the Renesas logo are trademarks of Renesas Electronics Corporation. All trademarks and registered trademarks are the property of their respective owners.



# Mouser Electronics

Authorized Distributor

Click to View Pricing, Inventory, Delivery & Lifecycle Information:

[Renesas Electronics:](#)

[9FGV0431AKLF](#) [9FGV0431AKLFT](#) [9FGV0431AKILFT](#) [9FGV0431AKILF](#)