

Jan.1.2022 Copyright 2022 HIROSE ELECTRIC CO., LTD. All Rights Reserved.  
 In case of consideration for using Automotive equipment / device which demand high reliability, kindly contact our sales window correspondents.

◆ RECOMMENDED PCB LAYOUT

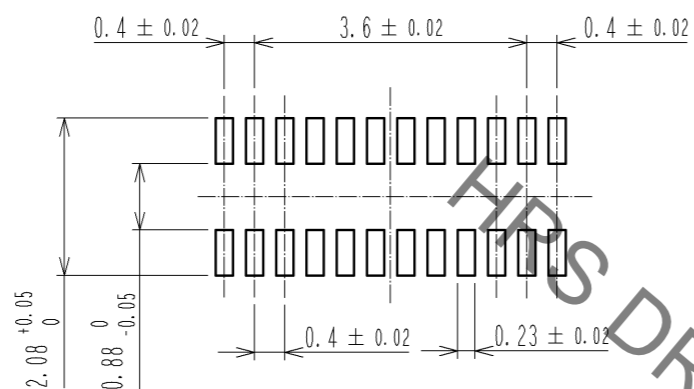

◆ RECOMMENDED METAL MASK DIMENSIONS <sup>△</sup>

METAL MASK THICKNESS : 100 μm

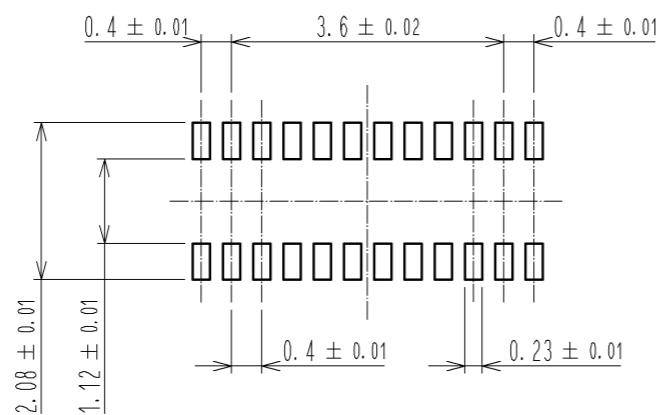

6 RECOMMENDED REFLOW TEMPERATURE PROFILE USING LEAD-FREE SOLDER PASTE.

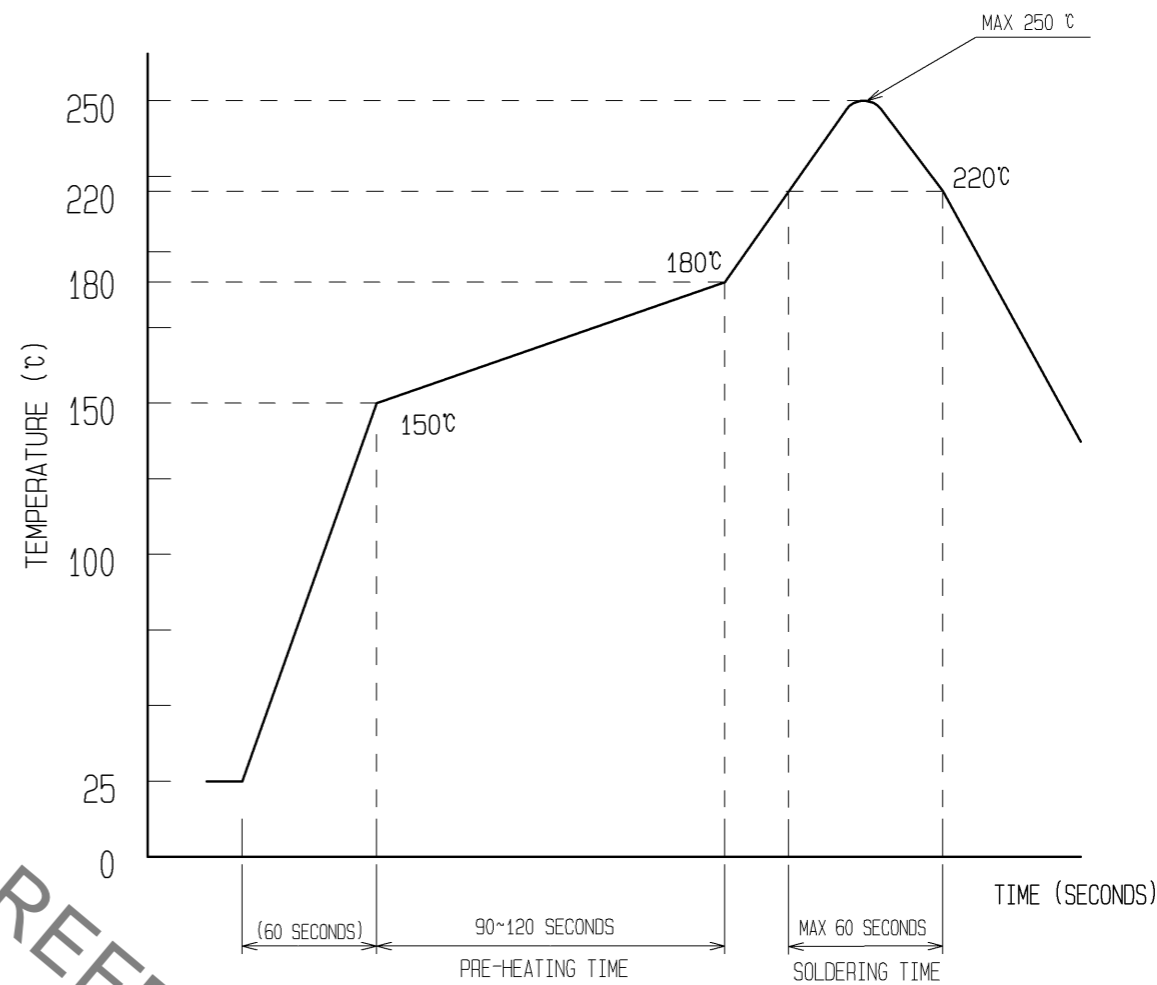

REFLOW METHOD: IR REFLOW  
 NUMBER OF REFLOW CYCLES: 2 CYCLES MAX.  
 1) REFLOW TIME  
 DURATION ABOVE 220°C: 60 SEC MAX.  
 (PEAK TEMPERATURE: 250°C MAX)  
 2) PRE-HEAT TIME  
 PRE-HEAT TEMPERATURE(MIN): 150°C  
 PRE-HEAT TEMPERATURE(MAX): 180°C  
 PRE-HEAT TIME: 90-120 SEC.

6 THIS TEMPERATURE PROFILE IS PER THE CONDITIONS SHOWN ABOVE. ADDITIONAL FACTORS, SUCH AS SOLDER PASTE TYPE, PCB SIZE AND OTHER MOUNTED COMPONENTS COULD AFFECT THE PROFILE. THEREFORE, A THOROUGH EVALUATION OF MOUNTING COONDITION IS REQUIRED PRIOR TO PRODUCTION. TEPERATURE IS MEASURED AT CONTACT LEAD.

<b>HRS</b>	DRAWING NO.	EDC3-332308-01
	PART NO.	BM20B(0.8)-20DP-0.4V(51)
	CODE NO.	CL684-9002-8-51

Jan.1.2022 Copyright 2022 HIROSE ELECTRIC CO., LTD. All Rights Reserved.  
 In case of consideration for using Automotive equipment / device which demand high reliability, kindly contact our sales window correspondents.

EMBOSED CARRIER TAPE PACKAGING (5:1)

STYLE AND DIMENTION OF REEL (FREE)

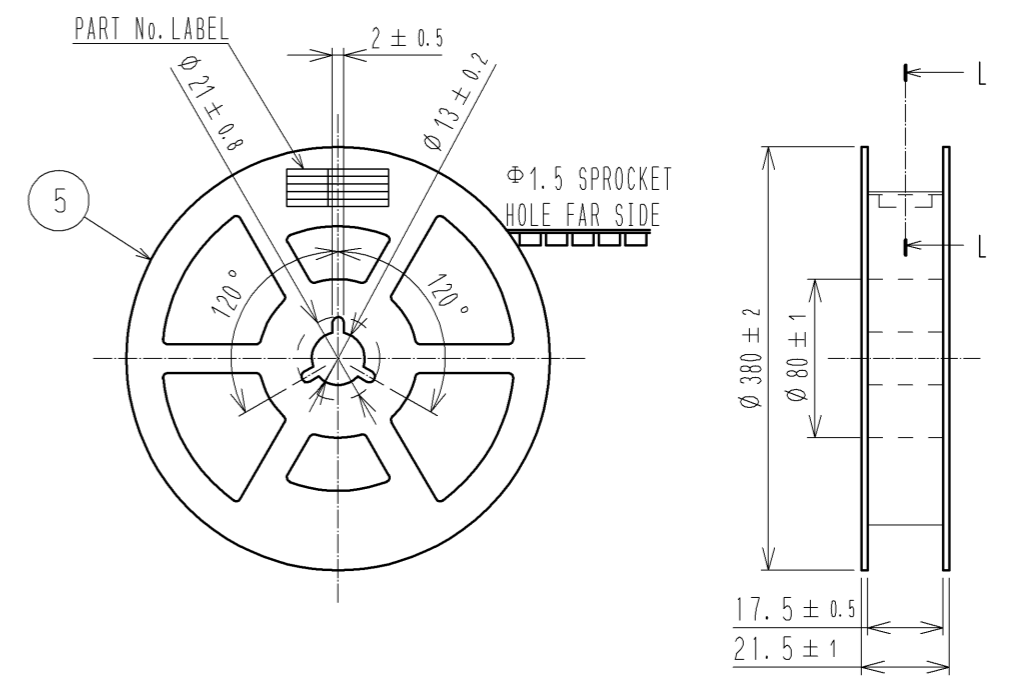
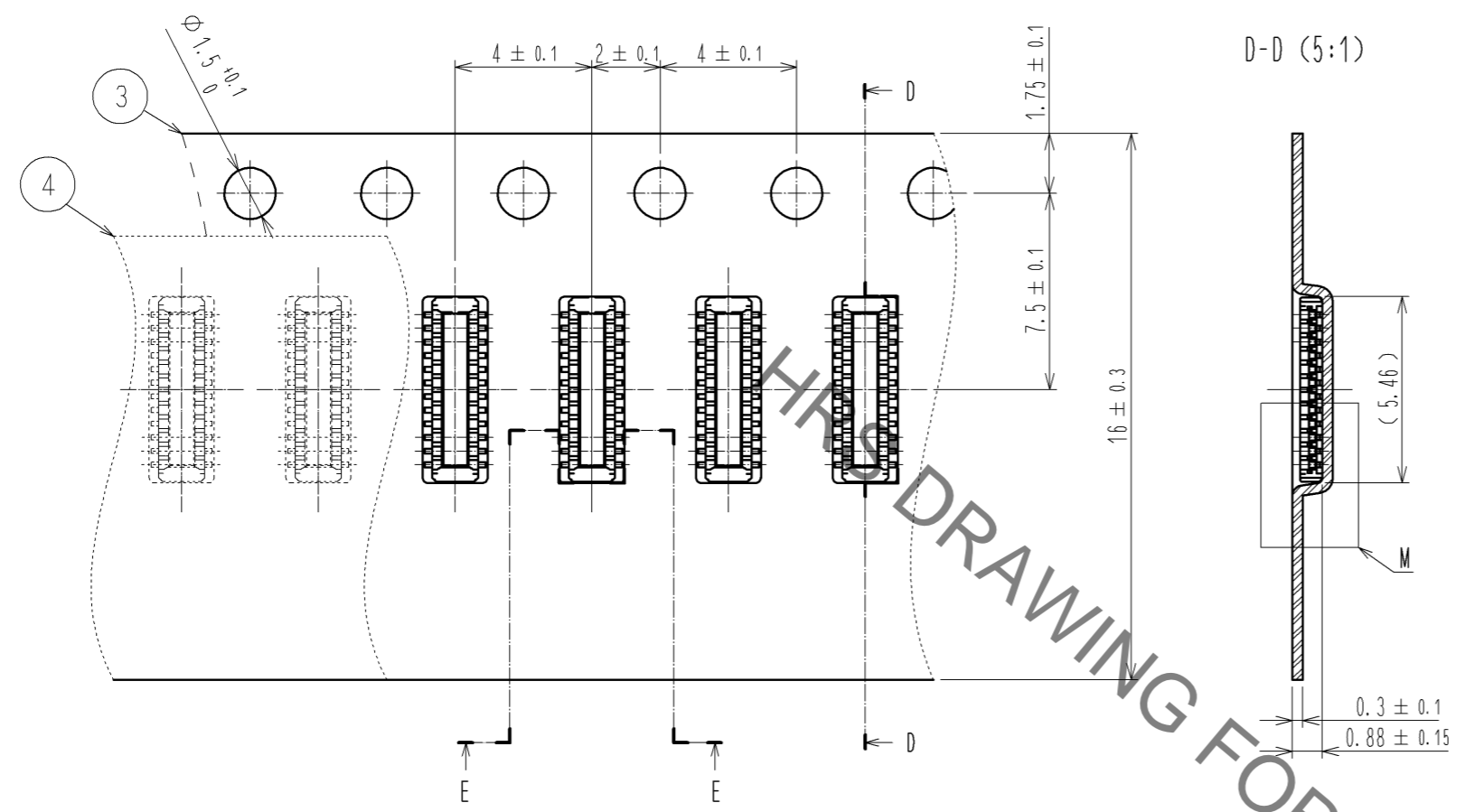

DIRECTION OF UNREELING

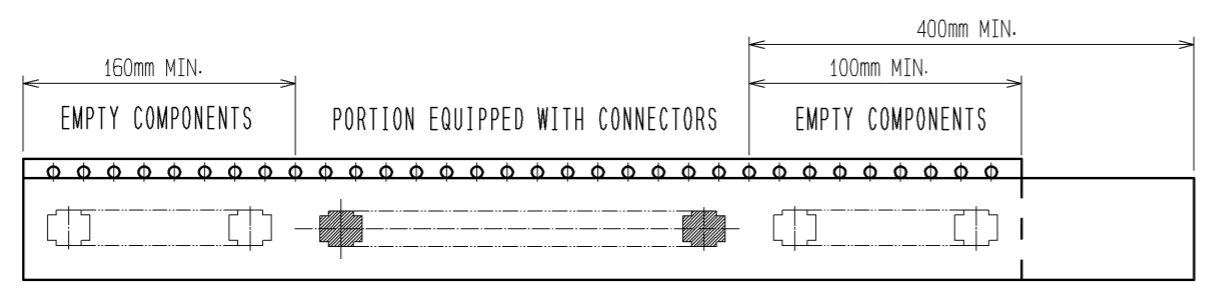
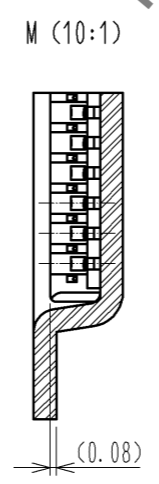
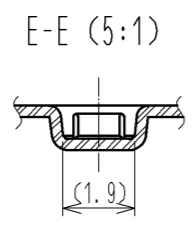
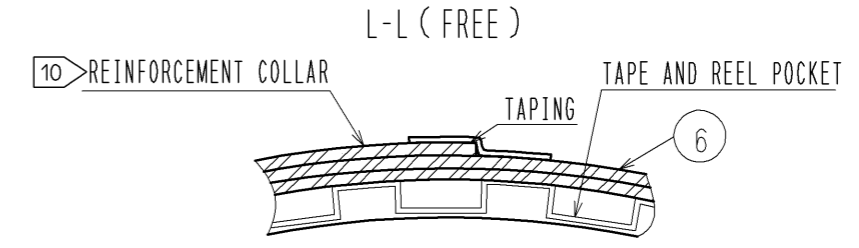

9 TAPING(FREE)

DETAIL OF PART No. LABEL

製造年月日	** ** *	DATE OF MANUFACTURED
製品コード	CL684-9002-8-51	CODE No.
製品名	BM20B(0.8)-20DP-0.4V(51)	PART No.
数量	8,000	QUANTITY
納入者	ヒロセ電機(株)	SUPPLIER

- 7. PER REEL 8000 CONNECTORS.
- 8. THE DIMENTION IN PARENTHESSES ARE FOR REFERENCE.
- 9 REFER TO JIS C 0806(PACKAGING OF COMPONENTS FOR AUTOMATIC HANDLING)
- 10 AFTER PACKAGING, ROLL 2 METERS OF THE REINFORCEMENT COLLAR TO OUTER CIRCUMFERENCE OF TAPE AND REEL POCKET. AND TAPE DOWN AT THE END THE COLLAR.

<b>HRS</b>	DRAWING NO.	EDC3-332308-01	
	PART NO.	BM20B(0.8)-20DP-0.4V(51)	
	CODE NO.	CL684-9002-8-51	3/3

# Mouser Electronics

Authorized Distributor

Click to View Pricing, Inventory, Delivery & Lifecycle Information:

[Hirose Electric:](#)

[BM20B\(0.8\)-20DP-0.4V\(51\)](#)