

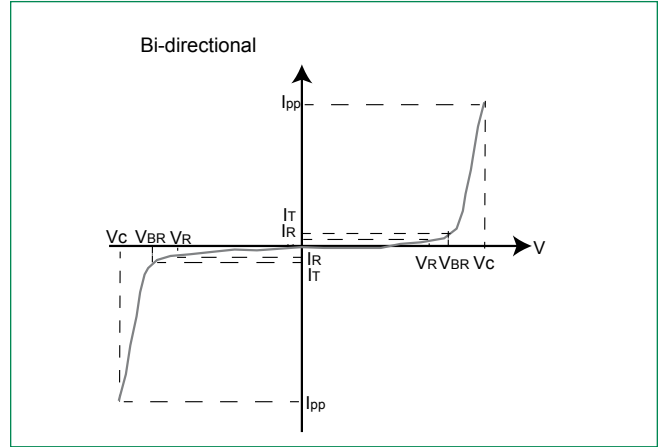
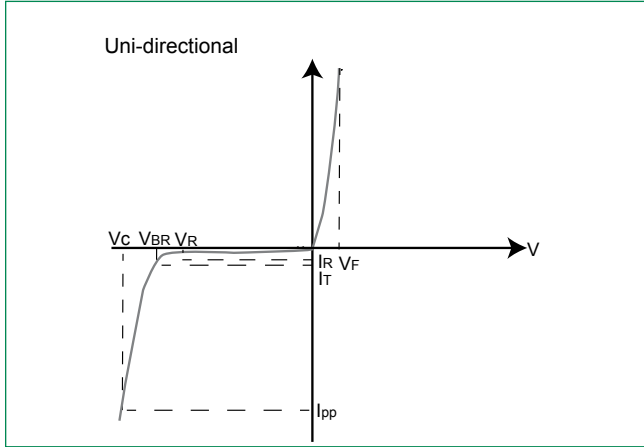
### Electrical Characteristics (T<sub>A</sub>=25°C unless otherwise noted)

Part Number		Marking Code		Breakdown Voltage VBR (Volts) @ IT		Test Current IT (mA)	Reverse Stand off Voltage VR (V)	Maximum Reverse Leakage @ VR IR (µA)	Maximum Peak Pulse Current Ipp (A) 10*1000us	Maximum Clamping Voltage @Ipp VC (V) 10*1000us	Agency Approval	
Uni	Bi	Uni	Bi	MIN	MAX						Uni	Bi
SMF5.0A	SMF5.0CA	AE	HE	6.40	7.00	10	5.0	400	21.7	9.2	X	-
SMF6.0A	SMF6.0CA	AG	HG	6.67	7.37	10	6.0	400	19.4	10.3	X	-
SMF6.5A	SMF6.5CA	AK	HK	7.22	7.98	10	6.5	250	17.9	11.2	X	-
SMF7.0A	SMF7.0CA	AM	HM	7.78	8.60	10	7.0	100	16.7	12.0	X	-
SMF7.5A	SMF7.5CA	AP	HP	8.33	9.21	1	7.5	50	15.5	12.9	X	-
SMF8.0A	SMF8.0CA	AR	HR	8.89	9.83	1	8.0	25	14.7	13.6	X	-
SMF8.5A	SMF8.5CA	AT	HT	9.44	10.40	1	8.5	10	13.9	14.4	X	-
SMF9.0A	SMF9.0CA	AV	HV	10.00	11.10	1	9.0	2.5	13.0	15.4	X	-
SMF10A	SMF10CA	AX	HX	11.10	12.30	1	10	2.5	11.8	17.0	X	-
SMF11A	SMF11CA	AZ	HZ	12.20	13.50	1	11	2.5	11.0	18.2	X	-
SMF12A	SMF12CA	BE	IE	13.30	14.70	1	12	2.5	10.1	19.9	X	-
SMF13A	SMF13CA	BG	IG	14.40	15.90	1	13	1.0	9.3	21.5	X	-
SMF14A	SMF14CA	BK	IK	15.60	17.20	1	14	1.0	8.6	23.2	X	-
SMF15A	SMF15CA	BM	IM	16.70	18.50	1	15	1.0	8.2	24.4	X	-
SMF16A	SMF16CA	BP	IP	17.80	19.70	1	16	1.0	7.7	26.0	X	-
SMF17A	SMF17CA	BR	IR	18.90	20.90	1	17	1.0	7.2	27.6	X	-
SMF18A	SMF18CA	BT	IT	20.00	22.10	1	18	1.0	6.8	29.2	X	-
SMF20A	SMF20CA	BV	IV	22.20	24.50	1	20	1.0	6.2	32.4	X	-
SMF22A	SMF22CA	BX	IX	24.40	26.90	1	22	1.0	5.6	35.5	X	-
SMF24A	SMF24CA	BZ	IZ	26.70	29.50	1	24	1.0	5.1	38.9	X	-
SMF26A	SMF26CA	CE	JE	28.90	31.90	1	26	1.0	4.8	42.1	X	-
SMF28A	SMF28CA	CG	JG	31.10	34.40	1	28	1.0	4.4	45.4	X	-
SMF30A	SMF30CA	CK	JK	33.30	36.80	1	30	1.0	4.1	48.4	X	-
SMF33A	SMF33CA	CM	JM	36.70	40.60	1	33	1.0	3.8	53.3	X	-
SMF36A	SMF36CA	CP	JP	40.00	44.20	1	36	1.0	3.4	58.1	X	-
SMF40A	SMF40CA	CR	JR	44.40	49.10	1	40	1.0	3.1	64.5	X	-
SMF43A	SMF43CA	CT	JT	47.80	52.80	1	43	1.0	2.9	69.4	X	-
SMF45A	SMF45CA	CV	JV	50.00	55.30	1	45	1.0	2.8	72.7	X	-
SMF48A	SMF48CA	CX	JX	53.30	58.90	1	48	1.0	2.6	77.4	X	-
SMF51A	SMF51CA	CZ	JZ	56.70	62.70	1	51	1.0	2.4	82.4	X	-
SMF54A	SMF54CA	DE	KE	60.00	66.30	1	54	1.0	2.3	87.1	X	-
SMF58A	SMF58CA	RG	KG	64.40	71.20	1	58	1.0	2.1	93.6	-	-
SMF60A	SMF60CA	RK	KK	66.70	73.70	1	60	1.0	2.1	96.8	-	-
SMF64A	SMF64CA	RM	KM	71.10	78.60	1	64	1.0	1.9	103.0	-	-
SMF70A	SMF70CA	RP	KP	77.80	86.00	1	70	1.0	1.7	113.0	-	-
SMF75A	SMF75CA	RR	KR	83.30	92.10	1	75	1.0	1.6	121.0	-	-
SMF78A	SMF78CA	RT	KT	86.70	95.80	1	78	1.0	1.6	126.0	-	-
SMF85A	SMF85CA	RV	KV	94.40	104.00	1	85	1.0	1.5	137.0	-	-
SMF90A	-	RW	-	100.00	111.00	1	90	1.0	1.2	146.0	-	-
SMF100A	-	RX	-	111.00	123.00	1	100	1.0	1.1	162.0	-	-
SMF110A	-	SE	-	122.00	135.00	1	110	1.0	1.1	177.0	-	-
SMF120A	-	SG	-	133.00	147.00	1	120	1.0	1.0	193.0	-	-
SMF130A	-	SK	-	144.00	159.00	1	130	1.0	1.0	209.0	-	-
SMF150A	-	SM	-	167.00	185.00	1	150	1.0	0.8	243.0	-	-
SMF160A	-	SP	-	178.00	197.00	1	160	1.0	0.8	259.0	-	-
SMF170A	-	SR	-	189.00	209.00	1	170	1.0	0.7	275.0	-	-
SMF180A	-	ST	-	201.00	222.00	1	180	1.0	0.7	292.0	-	-
SMF188A	-	SV	-	209.00	231.00	1	188	1.0	0.7	304.0	-	-
SMF200A	-	SX	-	224.00	247.00	1	200	1.0	0.6	324.0	-	-
SMF220A	-	SZ	-	246.00	272.00	1	220	1.0	0.6	356.0	-	-
SMF250A	-	TE	-	279.00	309.00	1	250	1.0	0.5	405.0	-	-

**-Notes:**

1. V<sub>BR</sub> measured after I<sub>T</sub> applied for 300µs, I<sub>T</sub> = square wave pulse or equivalent.
2. Surge current waveform per 10/1000µs exponential wave and derated per Fig.2.
3. All terms and symbols are consistent with ANSI/IEEE C62.35.
4. For bidirectional type having VR of 10 volts and less, the IR limit is double.

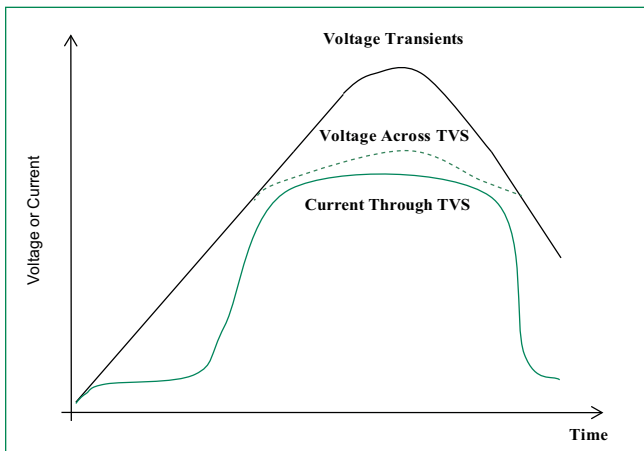
**I-V Curve Characteristics**



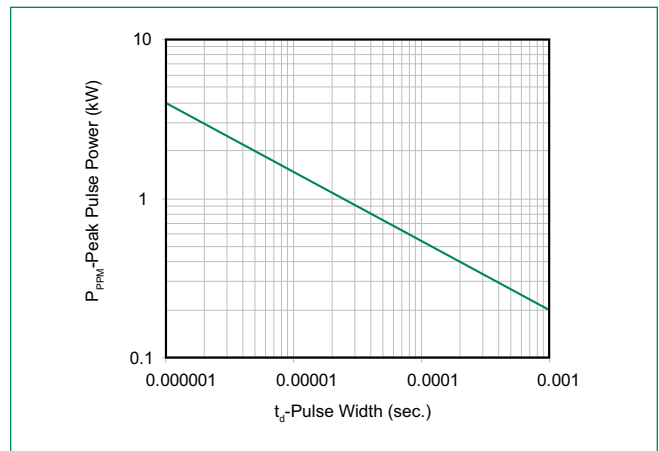
- $P_{PPM}$  Peak Pulse Power Dissipation** – Max power dissipation
- $V_R$  Stand-off Voltage** – Maximum voltage that can be applied to the TVS without operation
- $V_{BR}$  Breakdown Voltage** – Maximum voltage that flows through the TVS at a specified test current ( $I_T$ )
- $V_C$  Clamping Voltage** – Peak voltage measured across the TVS at a specified  $I_{ppm}$  (peak impulse current)
- $I_R$  Reverse Leakage Current** – Current measured at  $V_R$
- $V_F$  Forward Voltage Drop for Uni-directional**

**Ratings and Characteristic Curves ( $T_A=25^\circ\text{C}$  unless otherwise noted)**

**Figure 1 - TVS Transients Clamping Waveform**

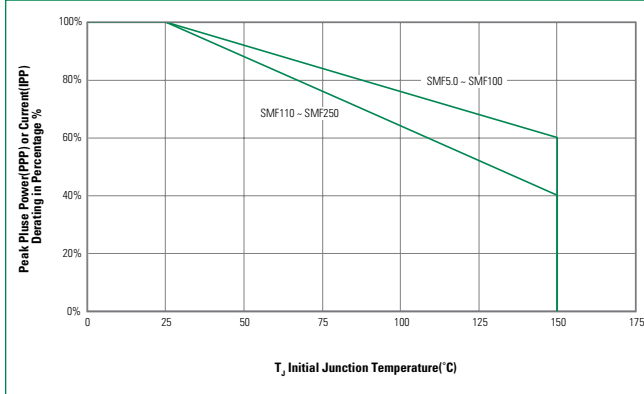


**Figure 2 - Peak Pulse Power Rating Curve**

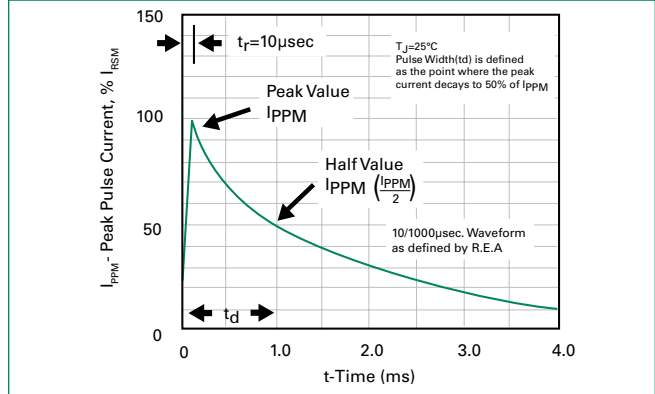


**Ratings and Characteristic Curves** ( $T_A=25^\circ\text{C}$  unless otherwise noted) (Continued)

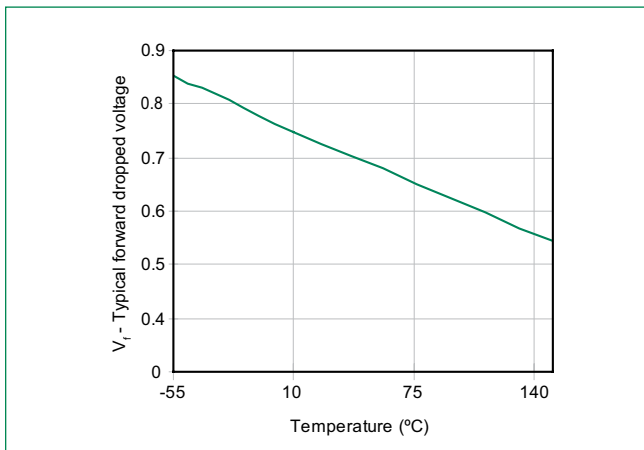
**Figure 3 - Peak Pulse Power Derating Curve**



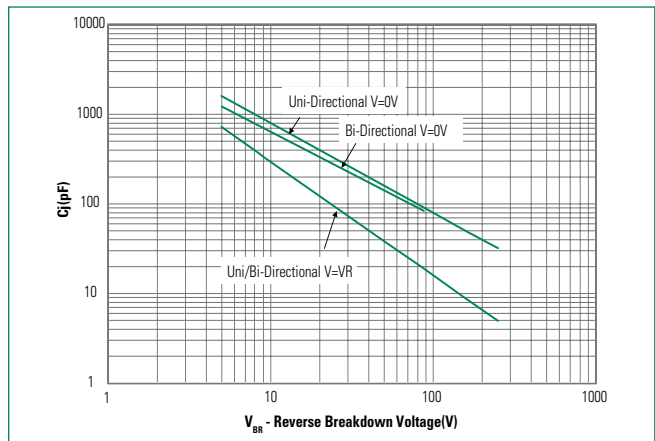
**Figure 4 - Pulse Waveform - 10/1000 $\mu\text{s}$**



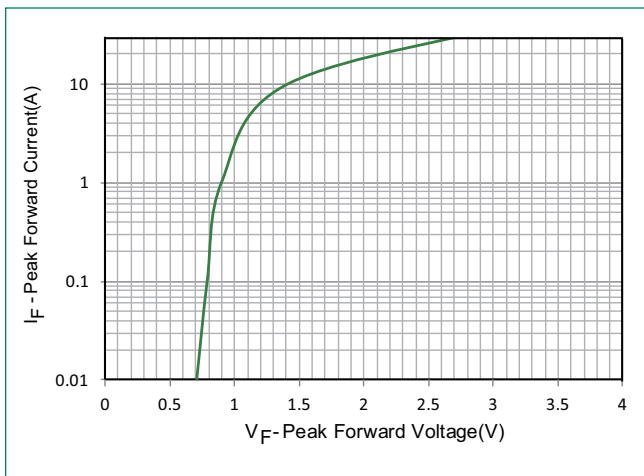
**Figure 5 - Forward Voltage**



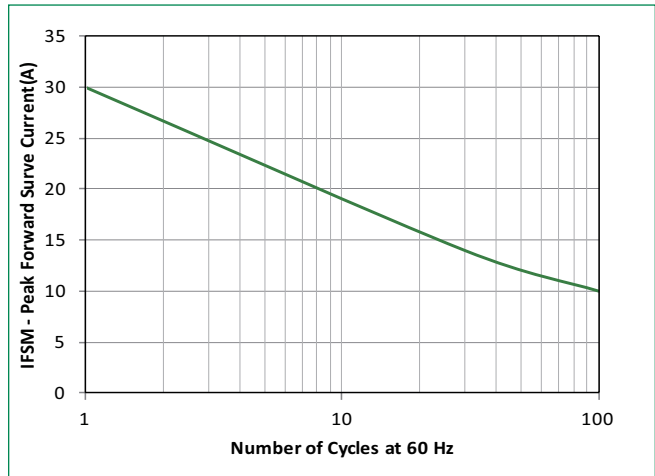
**Figure 6 - Typical Junction Capacitance**



**Figure 7 - Peak Forward Voltage Drop vs. Peak Forward Current**

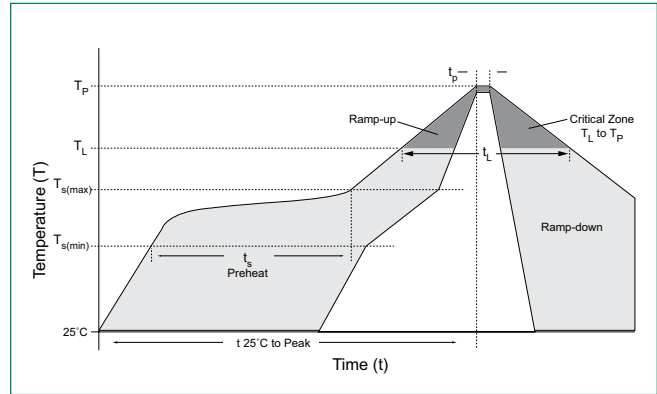


**Figure 8 - Maximum Non-Repetitive Forward Surge Current Uni-Directional Only**



### Soldering Parameters

<b>Reflow Condition</b>		Lead-free assembly
<b>Pre Heat</b>	- Temperature Min ( $T_{s(min)}$ )	150°C
	- Temperature Max ( $T_{s(max)}$ )	200°C
	- Time (min to max) ( $t_s$ )	60 – 120 secs
<b>Average ramp up rate (Liquidus Temp (<math>T_L</math>) to peak)</b>		3°C/second max
<b><math>T_{s(max)}</math> to <math>T_L</math> - Ramp-up Rate</b>		3°C/second max
<b>Reflow</b>	- Temperature ( $T_L$ ) (Liquidus)	217°C
	- Time (min to max) ( $t_L$ )	60 – 150 seconds
<b>Peak Temperature (<math>T_p</math>)</b>		260 <sup>+0/-5</sup> °C
<b>Time within 5°C of actual peak temperature (<math>t_p</math>)</b>		30 Seconds Max
<b>Ramp-down Rate</b>		6°C/second Max
<b>Time 25°C to peak Temperature (<math>T_p</math>)</b>		8 minutes Max.
<b>Do not exceed</b>		260°C



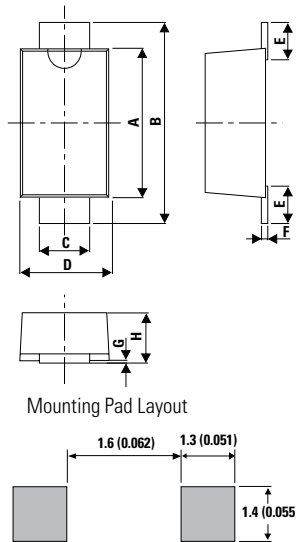
### Physical Specifications

<b>Case</b>	SOD-123FL plastic over glass passivated junction
<b>Polarity</b>	Color band denotes cathode except bipolar
<b>Terminal</b>	Matte tin-plated leads, solderable per JESD22-B102

### Environmental Specifications

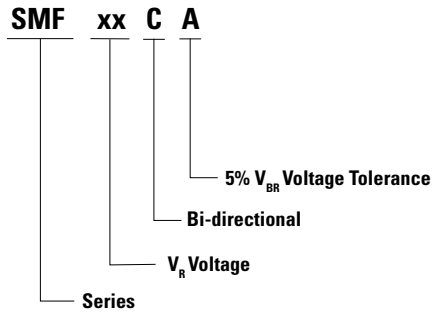
<b>High Temp. Storage</b>	JESD22-A103
<b>HTRB</b>	JESD22-A108
<b>Temperature Cycling</b>	JESD22-A104
<b>MSL</b>	JEDEC-J-STD-020, Level 1
<b>H3TRB</b>	JESD22-A101
<b>RSH</b>	JESD22-A111

### Dimensions - SOD-123FL Package

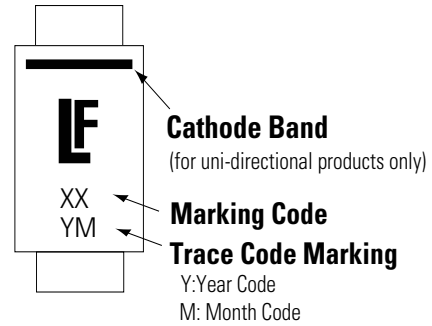


Dimensions	Millimeters		Inches		
	Min	Max	Min	Max	
<b>A</b>	SMF5.0A~SMF100A	2.50	2.90	0.0984	0.1142
	SMF110A~SMF250A	2.90	3.10	0.1142	0.1220
	SMF5.0CA~SMF85CA				
<b>B</b>		3.40	3.90	0.1339	0.1535
<b>C</b>		0.70	1.20	0.0275	0.0472
<b>D</b>		1.50	2.00	0.0591	0.0787
<b>E</b>		0.35	0.90	0.0138	0.0354
<b>F</b>		0.05	0.26	0.0020	0.0102
<b>G</b>		0.00	0.10	0.000	0.0039
<b>H</b>	SMF5.0A~SMF100A	0.95	1.10	0.0374	0.0433
	SMF110A~SMF250A	0.90	1.08	0.0354	0.0425
	SMF5.0CA~SMF85CA				

**Part Numbering System**



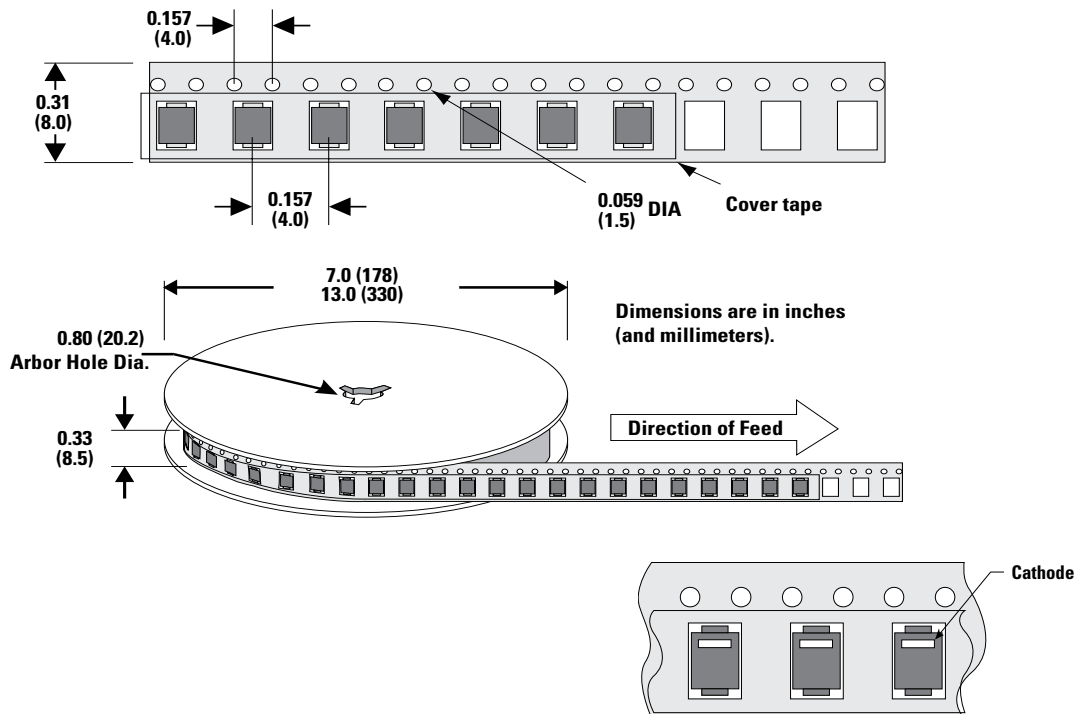
**Part Marking System**



**Packaging Options**

Part number	Component Package	Quantity	Packaging Option	Packaging Specification
SMFXXX	SOD-123FL	3000	Tape & Reel – 8mm tape/7" reel	EIA RS-481
SMFXXX-T13	SOD-123FL	10000	Tape & Reel – 8mm tape/13" reel	EIA RS-481

**Tape and Reel Specification**



# Mouser Electronics

Authorized Distributor

Click to View Pricing, Inventory, Delivery & Lifecycle Information:

## Littelfuse:

[SMF5.0A](#) [SMF6.5A](#) [SMF8.0A](#) [SMF9.0A](#) [SMF10A](#) [SMF11A](#) [SMF12A](#) [SMF33A](#) [SMF20A](#) [SMF18A](#) [SMF54A](#)  
[SMF51A](#) [SMF22A](#) [SMF45A](#) [SMF40A](#) [SMF28A](#) [SMF26A](#) [SMF43A](#) [SMF16A](#) [SMF13A](#) [SMF30A](#) [SMF24A](#)  
[SMF15A](#) [SMF14A](#) [SMF36A](#) [SMF17A](#) [SMF48A](#) [SMF13A-T13](#) [SMF17A-T13](#) [SMF51A-T13](#) [SMF8.0A-T13](#)  
[SMF7.0A-T13](#) [SMF16A-T13](#) [SMF6.0A-T13](#) [SMF8.5A-T13](#) [SMF24A-T13](#) [SMF22A-T13](#) [SMF15A-T13](#) [SMF5.0A-T13](#)  
[SMF7.5A-T13](#) [SMF9.0A-T13](#) [SMF54A-T13](#) [SMF14A-T13](#) [SMF45A-T13](#) [SMF26A-T13](#) [SMF36A-T13](#) [SMF6.5A-T13](#)  
[SMF12A-T13](#) [SMF43A-T13](#) [SMF33A-T13](#) [SMF20A-T13](#) [SMF30A-T13](#) [SMF11A-T13](#) [SMF10A-T13](#) [SMF48A-T13](#)  
[SMF18A-T13](#) [SMF28A-T13](#) [SMF40A-T13](#) [SMF58A](#) [SMF64A](#) [SMF78A](#)