

Part Numbering System

Family

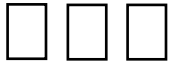

A2 - standard barrier
LP2 - low profile barrier

Terminal Style

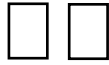

01* - handwired
02 - printed circuit
03 - non feed-thru
04 - wire wrap tail
06 - handwired
07 - extended pin
08 - printed circuit
09 - 0.250" QC short
10 - 0.187" QC
14 - printed circuit
19 - 0.250" QC long

Base/End



1 - std. base/
mnt. end
2 - std. base/
barrier end on
mount
3 - insulator
base/mnt. end
4 - insulator
base/barrier end
5 - closed base/
mount end
6 - closed base/
molded mount
end

Base/End
Note: 5 & 6
Styles only
available with 03
terminals.

Poles

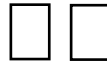

02 to 26 Barrier end
02 to 24 Mount end

Screw Options

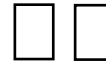

Blank-std. screws
00 - screws shipped
bulk
03* - stainless steel
04 - brass nickel-plated
07 - steel SEMS***
09* - brass SEMS
nickel-plated***
CA** - captive screw
WR* - wire ready

Options

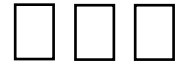

AB* - angle mnt. options (pg
11)
A1 to A9 - 0.250" QC
B1 to B9 - 0.187" QC
DR* - drilled right angle
(pg 11)
L1 to L6 marking options
(pg 25)
MP* mounting plates (pg 11)
R30 to R75 - right angle
bends (pg 11)
S1* - solder lug/flat
Covers - (pg 26)

* A2 only.

** Not compatible with 03-stainless steel screws.

*** SEMS screws not available with hardware options

Terminal Styles Inches (Millimeters)

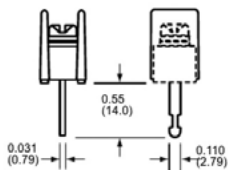

01
Handwired

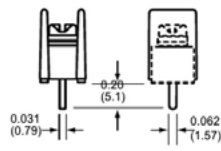

02
Printed Circuit



03
Non Feed-Thru

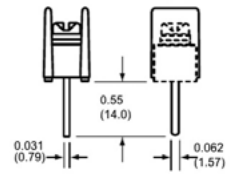

04
Wire Wrap Tail

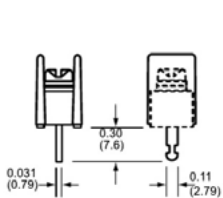

06
Handwired

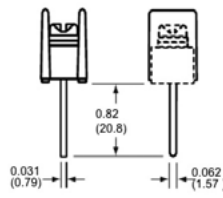

07
Extended Pin

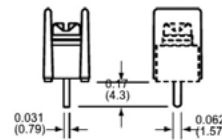

08
Printed Circuit

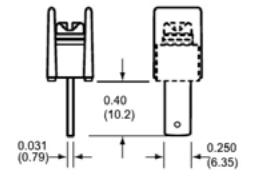

09
0.250" QC short

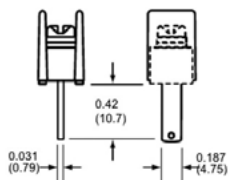

10
0.187" QC

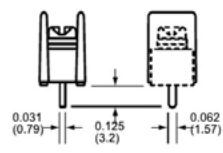

14
Printed Circuit

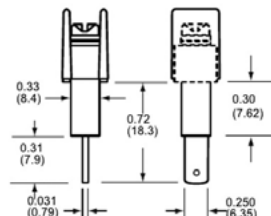

19
0.250" QC long

Screw Options

(Bulk ordering part numbers are in parentheses)

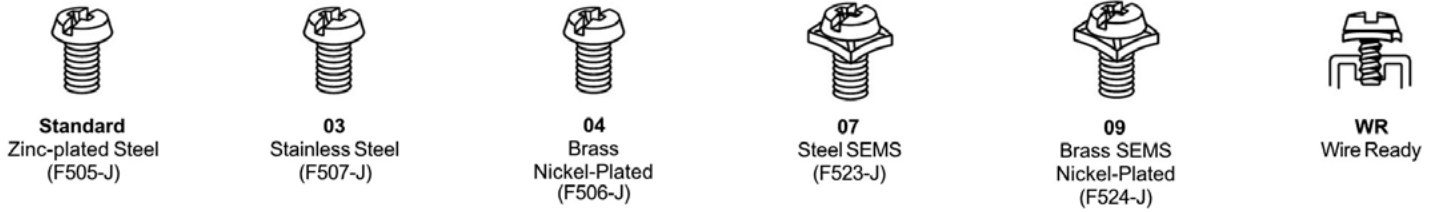

Hardware Options Inches (Millimeters)

(Bulk ordering part numbers are in parentheses)

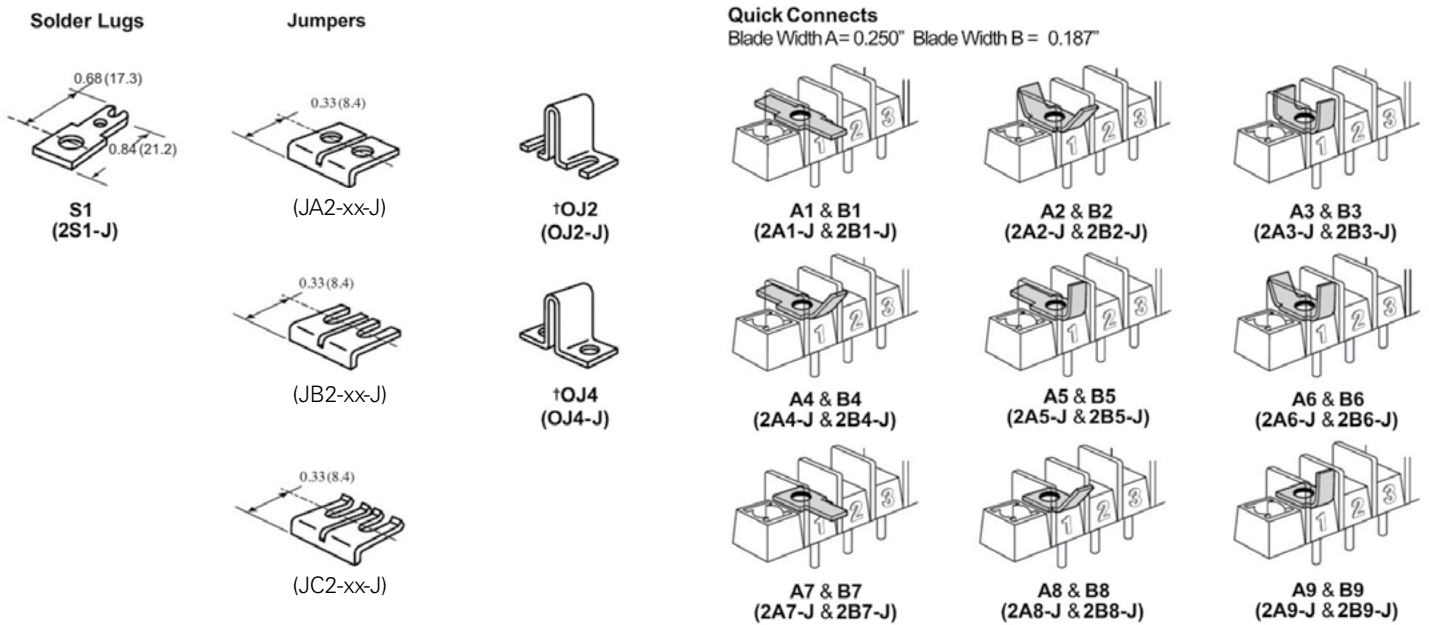

† Contact Eaton for desired configuration.

Base/End Options Inches (Millimeters)

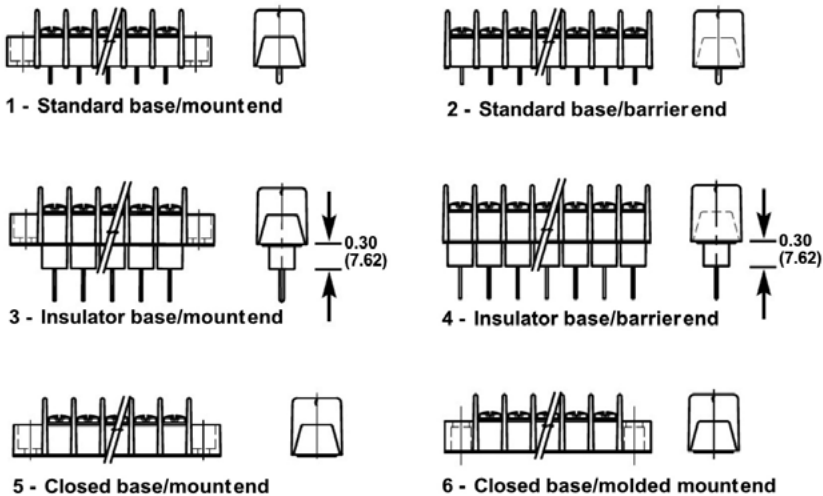

(not available with covers)

Mount End Details

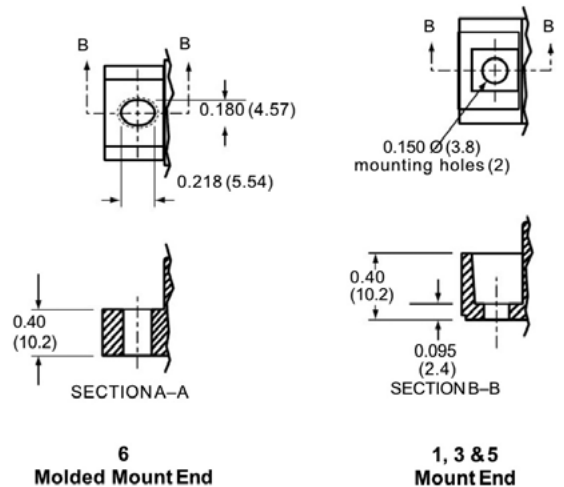

Note: On 1, 3 and 5 bases, Eaton may drill a terminal spacing to be a mount end. There will be no fit/form/function effect of mounting the product

Mounting Options Inches (Millimeters)

Right Angle Bends

Right angle terminals are offered on the A2 & LP2. Configurations are defined in these dimensions: X = pin extension beyond the block base; Z = length from block base to centerline of the terminal tip. Standard bends consist of the X and Z dimensions shown in the chart. Specify by adding the selected Bend Option Code to the terminal part number.

04 Terminal Bend Configurations

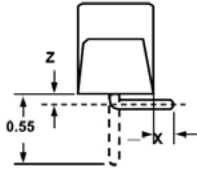

Bend Option Code	X (minimum)	Z	Available with insulator base
R35	0.01	0.23	No
R42	0.08	0.16	No
R46	0.12	0.12	No
R50	0.16	0.08	No

Dimensions in inches. To convert to millimeters, multiply by 25.4.

Angle Brackets

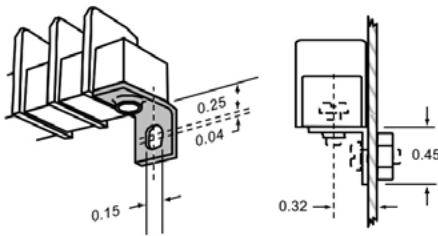

Option AB

Angle brackets enable block to be fastened at right angles to normal mount position. Bulk part number **2AB-J**.

Mounting Plates

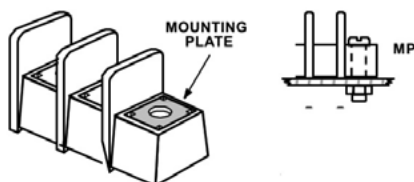

Options MP

MP Metal inserts with 0.150" dia. hole accept #6 screw. Bulk part number **2MP-J**.

07 Terminal Bend Configurations

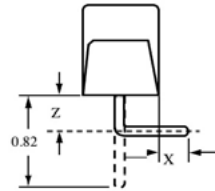

Bend Option Code	X (minimum)	Z	Available with insulator base
R35	0.01	0.50	Yes
R42	0.08	0.43	Yes
R46	0.12	0.39	Yes
R50	0.16	0.35	No
R53	0.19	0.32	No
R66	0.32	0.19	No
R75	0.41	0.10	No

Dimensions in inches. To convert to millimeters, multiply by 25.4.

Drilled Right Angle

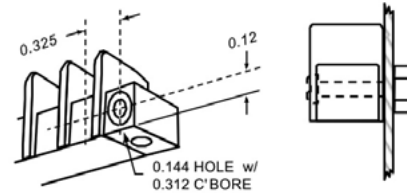

Option DR

Counterbored holes across mount ends of block enable fastening with two screws at right angles to normal mount position.

Part Numbering System

Family	Terminal Style	Base/End	Poles	Screw Options	Options
<div style="display: flex; gap: 10px;"> <div style="border: 1px solid black; padding: 2px 5px;">C</div> <div style="border: 1px solid black; padding: 2px 5px;">B</div> <div style="border: 1px solid black; padding: 2px 5px;">2</div> </div> <p>CB2 - closed back</p>	<div style="display: flex; gap: 10px;"> <div style="border: 1px solid black; width: 20px; height: 20px;"></div> <div style="border: 1px solid black; width: 20px; height: 20px;"></div> </div> <p>01 - handwired 02 - printed circuit 07 - extended pin 14 - printed circuit</p>	<div style="border: 1px solid black; width: 20px; height: 20px;"></div> <p>1 - mount end 2 - barrier end</p>	<div style="display: flex; gap: 10px;"> <div style="border: 1px solid black; width: 20px; height: 20px;"></div> <div style="border: 1px solid black; width: 20px; height: 20px;"></div> </div> <p>02 to 26 on barrier end 02 to 24 on mount end</p>	<div style="display: flex; gap: 10px;"> <div style="border: 1px solid black; width: 20px; height: 20px;"></div> <div style="border: 1px solid black; width: 20px; height: 20px;"></div> </div> <p>Blank—std. screws 07 - steel SEMS standard 09 - brass SEMS nickel-plated</p>	<div style="display: flex; gap: 10px;"> <div style="border: 1px solid black; width: 20px; height: 20px;"></div> <div style="border: 1px solid black; width: 20px; height: 20px;"></div> <div style="border: 1px solid black; width: 20px; height: 20px;"></div> </div> <p>AB - angle mounting brackets (pg 13) A7 to A9 - 0.250" QC B7 to B9 - 0.187" QC EB - exit back terminals EF - exit front terminals L1 to L6 marking options (pg 25) LT1 to LT6 marking options (pg 25) MP mtg. plates (pg 13) Covers - (pg 26)</p>

Terminal Styles Inches (Millimeters)

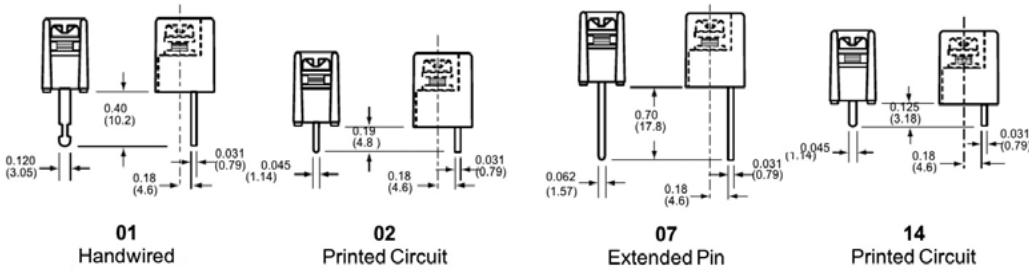

Screw Options

(Bulk ordering part numbers are in parentheses)

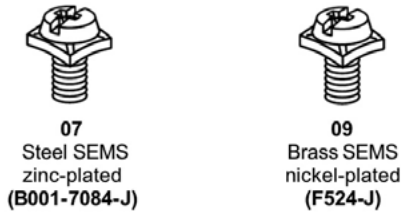

* NOTE: Wire ready screws standard on all terminal styles.

CB2 Terminal Exit Options Inches (Millimeters)

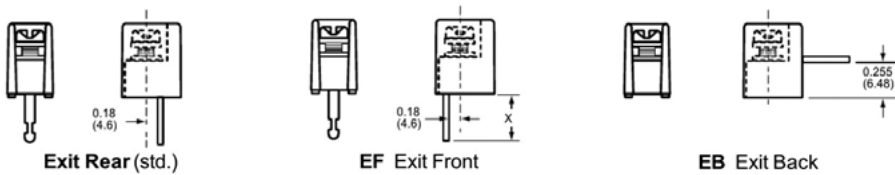

Hardware Options Inches (Millimeters)

(Bulk ordering part numbers are in parentheses)

Jumpers

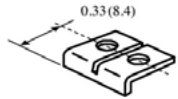

†1JA
(JA2-XX-J)



†1OJ2
(OJ2-J)

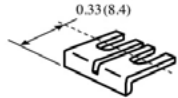

†1JB
(JB2-XX-J)



†1OJ4
(OJ4-J)

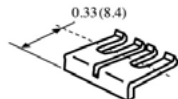

†1JC
(JC2-XX-J)

† Contact Eaton for desired configuration.

Quick Connects

Blade Width A = 0.250". Blade Width B = 0.187".

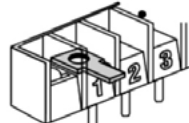

A7 & B7
(2A7-J & 2B7-J)



A8 & B8
(2A8-J & 2B8-J)

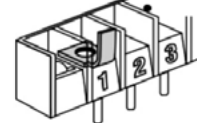

A9 & B9
(2A9-J & 2B9-J)

Mounting Options Inches (Millimeters)

Right Angle Mounting Bracket

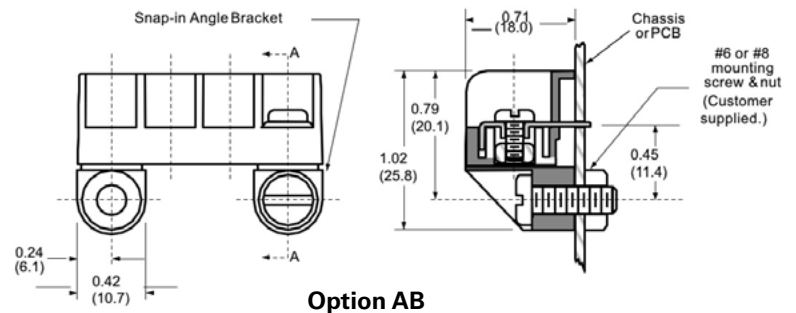
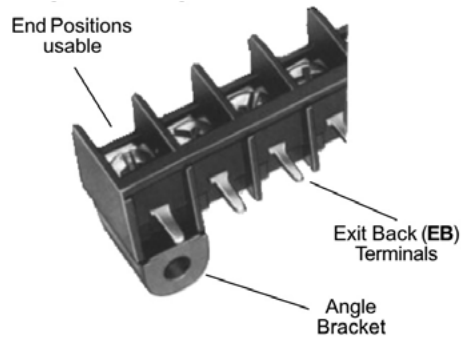

Option AB

Mounts blocks on PC boards at a right angle.

- Protects solder joints.
- Bracket snaps securely on block (no hardware required).
- Minimum strip length (end positions are usable).
- Mount with #6-32 or #8-32 screws (not supplied).
- Available on 3 pole configurations and greater

Mounting Plates



Option MP

MP Metal inserts with 0.150" dia. hole accept #6 screw.

Bulk part number **2MP-J**.

Tools & resources

- [Webpage](#)
- [Terminal block selector tool](#)
- [Terminal block cross reference](#)
- [Contact us](#)

Eaton
Electronics Division
1000 Eaton Boulevard
Cleveland, OH 44122
United States
Eaton.com/electronics

© 2020 Eaton
All Rights Reserved
Printed in USA
Publication No. 10682
June 2020

Eaton is a registered trademark.

All other trademarks are property
of their respective owners.

Follow us on social media to get the
latest product and support information.



Mouser Electronics

Authorized Distributor

Click to View Pricing, Inventory, Delivery & Lifecycle Information:

Eaton:

[LP201106MP](#) [LP202104MT](#) [LP202107MT](#) [LP202109MT](#) [LP20220809](#) [LP203130A3](#) [LP203130A6](#) [LP20350207S1](#)
[LP21931309MP8](#) [A20110904](#) [A204103R48MP](#) [A20140807RC](#) [A202230](#) [A20300209A8](#) [A202108MT](#)
[A20741507RC](#) [A20140307RC](#) [A20200707](#) [A21990404](#) [A203103A2JB](#) [A20223200](#) [A20910207MP8](#) [A204110R30](#)
[A20210204OJ2](#) [A204304SO](#) [A219904CA](#) [A207317R30](#) [A20132804](#) [A207113R77](#) [A207114R77](#) [A20300409A8](#)
[A20740207CARC](#) [A20222809CA](#) [A201002A9](#) [A207106R77](#) [A21941007RC](#) [A203504MT](#) [A20810607MT](#)
[A20813007MT](#) [A20740407CARC](#) [A202216MT](#) [A20812007MT](#) [A202110MT](#) [A202232](#) [CB20221500](#) [CB20222807EB](#)
[CB20223209](#) [LP21930209MP8](#) [CB20722807EB](#) [CB20721500](#) [CB20120707EBABLT1](#) [A207205](#)