

● Absolute maximum ratings

BU52054GWZ, BU52055GWZ (Ta=25°C)

Parameter	Symbol	Ratings	Unit
Power Supply Voltage	V _{DD}	-0.1~+4.5 ^{※1}	V
Output Current	I _{OUT}	±0.5	mA
Power Dissipation	P _d	100 ^{※2}	mW
Operating Temperature Range	T _{opr}	-40~+85	°C
Storage Temperature Range	T _{stg}	-40~+125	°C

※1. Not to exceed Pd

※2. Reduced by 1.00mW for each increase in Ta of 1°C over 25°C (mounted on 24mm × 20mm Glass-epoxy PCB)

BU52015GUL (Ta=25°C)

Parameter	Symbol	Ratings	Unit
Power Supply Voltage	V _{DD}	-0.1~+4.5 ^{※3}	V
Output Current	I _{OUT}	±0.5	mA
Power Dissipation	P _d	420 ^{※4}	mW
Operating Temperature Range	T _{opr}	-40~+85	°C
Storage Temperature Range	T _{stg}	-40~+125	°C

※3. Not to exceed Pd

※4. Reduced by 4.20mW for each increase in Ta of 1°C over 25°C (mounted on 50mm × 58mm Glass-epoxy PCB)

BU52001GUL (Ta=25°C)

Parameter	Symbol	Ratings	Unit
Power Supply Voltage	V _{DD}	-0.1~+4.5 ^{※5}	V
Output Current	I _{OUT}	±1	mA
Power Dissipation	P _d	420 ^{※6}	mW
Operating Temperature Range	T _{opr}	-40~+85	°C
Storage Temperature Range	T _{stg}	-40~+125	°C

※5. Not to exceed Pd

※6. Reduced by 4.20mW for each increase in Ta of 1°C over 25°C (mounted on 50mm × 58mm Glass-epoxy PCB)

BU52061NVX, BU52053NVX, BU52056NVX(Ta=25°C)

Parameter	Symbol	Ratings	Unit
Power Supply Voltage	V _{DD}	-0.1~+4.5 ^{※7}	V
Output Current	I _{OUT}	±0.5	mA
Power Dissipation	P _d	2049 ^{※8}	mW
Operating Temperature Range	T _{opr}	-40~+85	°C
Storage Temperature Range	T _{stg}	-40~+125	°C

※7. Not to exceed Pd

※8. Reduced by 4.20mW for each increase in Ta of 1°C over 25°C (mounted on 50mm × 58mm Glass-epoxy PCB)

BU52011HFV (Ta=25°C)

Parameter	Symbol	Ratings	Unit
Power Supply Voltage	V _{DD}	-0.1~+4.5 ^{※9}	V
Output Current	I _{OUT}	±0.5	mA
Power Dissipation	P _d	536 ^{※10}	mW
Operating Temperature Range	T _{opr}	-40~+85	°C
Storage Temperature Range	T _{stg}	-40~+125	°C

※9. Not to exceed Pd

※10. Reduced by 5.36mW for each increase in Ta of 1°C over 25°C (mounted on 70mm × 70 mm × 1.6mm Glass-epoxy PCB)

BU52021HFV (Ta=25°C)

Parameter	Symbol	Ratings	Unit
Power Supply Voltage	V _{DD}	-0.1~+4.5 ^{※11}	V
Output Current	I _{OUT}	±1	mA
Power Dissipation	P _d	536 ^{※12}	mW
Operating Temperature Range	T _{opr}	-40~+85	°C
Storage Temperature Range	T _{stg}	-40~+125	°C

※11 Not to exceed Pd

※12. Reduced by 5.36mW for each increase in Ta of 1°C over 25°C (mounted on 70mm × 70 mm × 1.6mm Glass-epoxy PCB)

BU52025G (Ta=25°C)

Parameter	Symbol	Ratings	Unit
Power Supply Voltage	V _{DD}	-0.1~+4.5 ^{※13}	V
Output Current	I _{OUT}	±1	mA
Power Dissipation	P _d	540 ^{※14}	mW
Operating Temperature Range	T _{opr}	-40~+85	°C
Storage Temperature Range	T _{stg}	-40~+125	°C

※13. Not to exceed Pd

※14. Reduced by 5.40mW for each increase in Ta of 1°C over 25°C (mounted on 70mm × 70 mm × 1.6mm Glass-epoxy PCB)

BD7411G (Ta=25°C)

Parameter	Symbol	Ratings	Unit
Power Supply Voltage	V _{DD}	-0.3~+7.0 ^{※15}	V
Output Current	I _{OUT}	±1	mA
Power Dissipation	P _d	540 ^{※16}	mW
Operating Temperature Range	T _{opr}	-40~+85	°C
Storage Temperature Range	T _{stg}	-55~+150	°C

※15. Not to exceed Pd

※16. Reduced by 5.40mW for each increase in Ta of 1°C over 25°C (mounted on 70mm × 70 mm × 1.6mm Glass-epoxy PCB)

●Magnetic, Electrical characteristics

BU52054GWZ (Unless otherwise specified, $V_{DD}=1.80V$, $T_a=25^{\circ}C$)

Parameter	Symbol	Limits			Unit	Conditions
		Min.	Typ.	Max.		
Power Supply Voltage	V_{DD}	1.65	1.80	3.60	V	
Operate Point	B_{opS}	-	6.3	7.9	mT	
	B_{opN}	-7.9	-6.3	-		
Release Point	B_{rpS}	3.5	5.4	-	mT	
	B_{rpN}	-	-5.4	-3.5		
Hysteresis	B_{hysS}	-	0.9	-	mT	
	B_{hysN}	-	0.9	-		
Period	T_p	-	50	100	ms	
Output High Voltage	V_{OH}	$V_{DD}-0.2$	-	-	V	$B_{rpN} < B < B_{rpS}$ $I_{OUT} = -0.5mA$ ※17
Output Low Voltage	V_{OL}	-	-	0.2	V	$B < B_{opN}$, $B_{opS} < B$ $I_{OUT} = +0.5mA$ ※17
Supply Current	$I_{DD(AVG)}$	-	5	8	μA	Average
Supply Current During Startup Time	$I_{DD(EN)}$	-	2.8	-	mA	During Startup Time Value
Supply Current During Standby Time	$I_{DD(DIS)}$	-	1.8	-	μA	During Standby Time Value

※17 B = Magnetic flux density
 1mT=10Gauss

Positive (“+”) polarity flux is defined as the magnetic flux from south pole which is direct toward to the branded face of the sensor.

After applying power supply, it takes one cycle of period (T_p) to become definite output.

Radiation hardness is not designed.

BU52055GWZ (Unless otherwise specified, $V_{DD}=1.80V$, $T_a=25^{\circ}C$)

Parameter	Symbol	Limits			Unit	Conditions
		Min.	Typ.	Max.		
Power Supply Voltage	V_{DD}	1.65	1.80	3.60	V	
Operate Point	B_{opS}	-	4.1	5.5	mT	
	B_{opN}	-5.5	-4.1	-		
Release Point	B_{rpS}	1.5	3.3	-	mT	
	B_{rpN}	-	-3.3	-1.5		
Hysteresis	B_{hysS}	-	0.8	-	mT	
	B_{hysN}	-	0.8	-		
Period	T_p	-	50	100	ms	
Output High Voltage	V_{OH}	$V_{DD}-0.2$	-	-	V	$B_{rpN} < B < B_{rpS}$ $I_{OUT} = -0.5mA$ ※18
Output Low Voltage	V_{OL}	-	-	0.2	V	$B < B_{opN}$, $B_{opS} < B$ $I_{OUT} = +0.5mA$ ※18
Supply Current	$I_{DD(AVG)}$	-	5	8	μA	Average
Supply Current During Startup Time	$I_{DD(EN)}$	-	2.8	-	mA	During Startup Time Value
Supply Current During Standby Time	$I_{DD(DIS)}$	-	1.8	-	μA	During Standby Time Value

※18 B = Magnetic flux density

1mT=10Gauss

Positive (“+”) polarity flux is defined as the magnetic flux from south pole which is direct toward to the branded face of the sensor.

After applying power supply, it takes one cycle of period (T_p) to become definite output.

Radiation hardness is not designed.

BU52015GUL (Unless otherwise specified, $V_{DD}=1.80V$, $T_a=25^{\circ}C$)

Parameter	Symbol	Limits			Unit	Conditions
		Min.	Typ.	Max.		
Power Supply Voltage	V_{DD}	1.65	1.80	3.30	V	
Operate Point	B_{opS}	-	3.0	5.0	mT	
	B_{opN}	-5.0	-3.0	-		
Release Point	B_{rpS}	0.6	2.1	-	mT	
	B_{rpN}	-	-2.1	-0.6		
Hysteresis	B_{hysS}	-	0.9	-	mT	
	B_{hysN}	-	0.9	-		
Period	T_p	-	50	100	ms	
Output High Voltage	V_{OH}	$V_{DD}-0.2$	-	-	V	OUT1: $B_{rpN} < B < B_{rpS}$ ※19 OUT2: $B < B_{opN}$, $B_{opS} < B$ $I_{OUT} = -0.5mA$
Output Low Voltage	V_{OL}	-	-	0.2	V	OUT1: $B < B_{opN}$, $B_{opS} < B$ ※19 OUT2: $B_{rpN} < B < B_{rpS}$ $I_{OUT} = +0.5mA$
Supply Current 1	$I_{DD1(AVG)}$	-	5	8	μA	$V_{DD}=1.8V$, Average
Supply Current During Startup Time 1	$I_{DD1(EN)}$	-	2.8	-	mA	$V_{DD}=1.8V$, During Startup Time Value
Supply Current During Standby Time 1	$I_{DD1(DIS)}$	-	1.8	-	μA	$V_{DD}=1.8V$, During Standby Time Value
Supply Current 2	$I_{DD2(AVG)}$	-	8	12	μA	$V_{DD}=2.7V$, Average
Supply Current During Startup Time 2	$I_{DD2(EN)}$	-	4.5	-	mA	$V_{DD}=2.7V$, During Startup Time Value
Supply Current During Standby Time 2	$I_{DD2(DIS)}$	-	4.0	-	μA	$V_{DD}=2.7V$, During Standby Time Value

※19 B = Magnetic flux density
 1mT=10Gauss

Positive (“+”) polarity flux is defined as the magnetic flux from south pole which is direct toward to the branded face of the sensor.

After applying power supply, it takes one cycle of period (T_p) to become definite output.

Radiation hardness is not designed.

BU52001GUL (Unless otherwise specified, $V_{DD}=3.0V$, $T_a=25^{\circ}C$)

Parameter	Symbol	Limits			Unit	Conditions
		Min.	Typ.	Max.		
Power Supply Voltage	V_{DD}	2.4	3.0	3.3	V	
Operate Point	B_{opS}	-	3.7	5.5	mT	
	B_{opN}	-5.5	-3.7	-		
Release Point	B_{rpS}	0.8	2.9	-	mT	
	B_{rpN}	-	-2.9	-0.8		
Hysteresis	B_{hysS}	-	0.8	-	mT	
	B_{hysN}	-	0.8	-		
Period	T_p	-	50	100	ms	
Output High Voltage	V_{OH}	$V_{DD}-0.4$	-	-	V	$B_{rpN} < B < B_{rpS}$ $I_{OUT} = -1.0mA$ ※20
Output Low Voltage	V_{OL}	-	-	0.4	V	$B < B_{opN}, B_{opS} < B$ $I_{OUT} = +1.0mA$ ※20
Supply Current	$I_{DD(AVG)}$	-	8	12	μA	Average
Supply Current During Startup Time	$I_{DD(EN)}$	-	4.7	-	mA	During Startup Time Value
Supply Current During Standby Time	$I_{DD(DIS)}$	-	3.8	-	μA	During Standby Time Value

※20 B = Magnetic flux density
 1mT=10Gauss

Positive (“+”) polarity flux is defined as the magnetic flux from south pole which is direct toward to the branded face of the sensor.

After applying power supply, it takes one cycle of period (T_p) to become definite output.

Radiation hardness is not designed.

BU52061NVX (Unless otherwise specified, $V_{DD}=1.80V$, $T_a=25^{\circ}C$)

Parameter	Symbol	Limits			Unit	Conditions
		Min.	Typ.	Max.		
Power Supply Voltage	V_{DD}	1.65	1.80	3.60	V	
Operate Point	B_{opS}	2.3	3.3	4.7	mT	
	B_{opN}	-4.7	-3.3	-2.3		
Release Point	B_{rpS}	1.2	2.4	3.4	mT	
	B_{rpN}	-3.4	-2.4	-1.2		
Hysteresis	B_{hysS}	-	0.9	-	mT	
	B_{hysN}	-	0.9	-		
Period	T_p	-	50	100	ms	
Output High Voltage	V_{OH}	$V_{DD}-0.2$	-	-	V	$B_{rpN} < B < B_{rpS}$ $I_{OUT} = -0.5mA$ ※21
Output Low Voltage	V_{OL}	-	-	0.2	V	$B < B_{opN}$, $B_{opS} < B$ $I_{OUT} = +0.5mA$ ※21
Supply Current 1	$I_{DD1(AVG)}$	-	4	7	μA	$V_{DD}=1.8V$, Average
Supply Current During Startup Time 1	$I_{DD1(EN)}$	-	5.0	-	mA	$V_{DD}=1.8V$, During Startup Time Value
Supply Current During Standby Time 1	$I_{DD1(DIS)}$	-	1.8	-	μA	$V_{DD}=1.8V$, During Standby Time Value
Supply Current 2	$I_{DD2(AVG)}$	-	9	16	μA	$V_{DD}=3.0V$, Average
Supply Current During Startup Time 2	$I_{DD2(EN)}$	-	9.0	-	mA	$V_{DD}=3.0V$, During Startup Time Value
Supply Current During Standby Time 2	$I_{DD2(DIS)}$	-	4.4	-	μA	$V_{DD}=3.0V$, During Standby Time Value

※21 B = Magnetic flux density
 1mT=10Gauss

Positive (“+”) polarity flux is defined as the magnetic flux from south pole which is direct toward to the branded face of the sensor.

After applying power supply, it takes one cycle of period (T_p) to become definite output.

Radiation hardness is not designed.

BU52053NVX (Unless otherwise specified, $V_{DD}=1.80V$, $T_a=25^{\circ}C$)

Parameter	Symbol	Limits			Unit	Conditions
		Min.	Typ.	Max.		
Power Supply Voltage	V_{DD}	1.65	1.80	3.60	V	
Operate Point	B_{opS}	-	3.0	5.0	mT	
	B_{opN}	-5.0	-3.0	-		
Release Point	B_{rpS}	0.6	2.1	-	mT	
	B_{rpN}	-	-2.1	-0.6		
Hysteresis	B_{hysS}	-	0.9	-	mT	
	B_{hysN}	-	0.9	-		
Period	T_p	-	50	100	ms	
Output High Voltage	V_{OH}	$V_{DD}-0.2$	-	-	V	$B_{rpN} < B < B_{rpS}$ $I_{OUT} = -0.5mA$ ※22
Output Low Voltage	V_{OL}	-	-	0.2	V	$B < B_{opN}$, $B_{opS} < B$ $I_{OUT} = +0.5mA$ ※22
Supply Current	$I_{DD(AVG)}$	-	5	8	μA	Average
Supply Current During Startup Time	$I_{DD(EN)}$	-	2.8	-	mA	During Startup Time Value
Supply Current During Standby Time	$I_{DD(DIS)}$	-	1.8	-	μA	During Standby Time Value

※22 B = Magnetic flux density

1mT=10Gauss

Positive (“+”) polarity flux is defined as the magnetic flux from south pole which is direct toward to the branded face of the sensor.

After applying power supply, it takes one cycle of period (T_p) to become definite output.

Radiation hardness is not designed.

BU52011HFV (Unless otherwise specified, $V_{DD}=1.80V$, $T_a=25^{\circ}C$)

Parameter	Symbol	Limits			Unit	Conditions
		Min.	Typ.	Max.		
Power Supply Voltage	V_{DD}	1.65	1.80	3.30	V	
Operate Point	B_{opS}	-	3.0	5.0	mT	
	B_{opN}	-5.0	-3.0	-		
Release Point	B_{rpS}	0.6	2.1	-	mT	
	B_{rpN}	-	-2.1	-0.6		
Hysteresis	B_{hysS}	-	0.9	-	mT	
	B_{hysN}	-	0.9	-		
Period	T_p	-	50	100	ms	
Output High Voltage	V_{OH}	$V_{DD}-0.2$	-	-	V	$B_{rpN} < B < B_{rpS}$ $I_{OUT} = -0.5mA$ ※23
Output Low Voltage	V_{OL}	-	-	0.2	V	$B < B_{opN}$, $B_{opS} < B$ $I_{OUT} = +0.5mA$ ※23
Supply Current 1	$I_{DD1(AVG)}$	-	5	8	μA	$V_{DD}=1.8V$, Average
Supply Current During Startup Time 1	$I_{DD1(EN)}$	-	2.8	-	mA	$V_{DD}=1.8V$, During Startup Time Value
Supply Current During Standby Time 1	$I_{DD1(DIS)}$	-	1.8	-	μA	$V_{DD}=1.8V$, During Standby Time Value
Supply Current 2	$I_{DD2(AVG)}$	-	8	12	μA	$V_{DD}=2.7V$, Average
Supply Current During Startup Time 2	$I_{DD2(EN)}$	-	4.5	-	mA	$V_{DD}=2.7V$, During Startup Time Value
Supply Current During Standby Time 2	$I_{DD2(DIS)}$	-	4.0	-	μA	$V_{DD}=2.7V$, During Standby Time Value

※23 B = Magnetic flux density
 1mT=10Gauss

Positive (“+”) polarity flux is defined as the magnetic flux from south pole which is direct toward to the branded face of the sensor.

After applying power supply, it takes one cycle of period (T_p) to become definite output.

Radiation hardness is not designed.

BU52056NVX (Unless otherwise specified, $V_{DD}=1.80V$, $T_a=25^{\circ}C$)

Parameter	Symbol	Limits			Unit	Conditions
		Min.	Typ.	Max.		
Power Supply Voltage	V_{DD}	1.65	1.80	3.60	V	
Operate Point	B_{opS}	-	4.6	6.4	mT	
	B_{opN}	-6.4	-4.6	-		
Release Point	B_{rpS}	2.0	3.8	-	mT	
	B_{rpN}	-	-3.8	-2.0		
Hysteresis	B_{hysS}	-	0.8	-	mT	
	B_{hysN}	-	0.8	-		
Period	T_p	-	50	100	ms	
Output High Voltage	V_{OH}	$V_{DD}-0.2$	-	-	V	$B_{rpN} < B < B_{rpS}$ $I_{OUT} = -0.5mA$ ※24
Output Low Voltage	V_{OL}	-	-	0.2	V	$B < B_{opN}, B_{opS} < B$ $I_{OUT} = +0.5mA$ ※24
Supply Current	$I_{DD(AVG)}$	-	5	8	μA	Average
Supply Current During Startup Time	$I_{DD(EN)}$	-	2.8	-	mA	During Startup Time Value
Supply Current During Standby Time	$I_{DD(DIS)}$	-	1.8	-	μA	During Standby Time Value

※24 B = Magnetic flux density

1mT=10Gauss

Positive (“+”) polarity flux is defined as the magnetic flux from south pole which is direct toward to the branded face of the sensor.

After applying power supply, it takes one cycle of period (T_p) to become definite output.

Radiation hardness is not designed.

BU52021HFV, BU52025G (Unless otherwise specified, $V_{DD}=3.0V$, $T_a=25^{\circ}C$)

Parameter	Symbol	Limits			Unit	Conditions
		Min.	Typ.	Max.		
Power Supply Voltage	V_{DD}	2.4	3.0	3.6	V	
Operate Point	B_{opS}	-	3.7	5.5	mT	
	B_{opN}	-5.5	-3.7	-		
Release Point	B_{rpS}	0.8	2.9	-	mT	
	B_{rpN}	-	-2.9	-0.8		
Hysteresis	B_{hysS}	-	0.8	-	mT	
	B_{hysN}	-	0.8	-		
Period	T_p	-	50	100	ms	
Output High Voltage	V_{OH}	$V_{DD}-0.4$	-	-	V	$B_{rpN} < B < B_{rpS}$ $I_{OUT} = -1.0mA$ ※25
Output Low Voltage	V_{OL}	-	-	0.4	V	$B < B_{opN}$, $B_{opS} < B$ $I_{OUT} = +1.0mA$ ※25
Supply Current	$I_{DD(AVG)}$	-	8	12	μA	Average
Supply Current During Startup Time	$I_{DD(EN)}$	-	4.7	-	mA	During Startup Time Value
Supply Current During Standby Time	$I_{DD(DIS)}$	-	3.8	-	μA	During Standby Time Value

※25 B = Magnetic flux density

1mT=10Gauss

Positive (“+”) polarity flux is defined as the magnetic flux from south pole which is direct toward to the branded face of the sensor.

After applying power supply, it takes one cycle of period (T_p) to become definite output.

Radiation hardness is not designed.

BD7411G (Unless otherwise specified, $V_{DD}=5.0V$, $T_a=25^{\circ}C$)

Parameter	Symbol	Limits			Unit	Conditions
		Min.	Typ.	Max.		
Power Supply Voltage	V_{DD}	4.5	5.0	5.5	V	
Operate Point	B_{opS}	-	3.4	5.6	mT	
	B_{opN}	-5.6	-3.4	-		
Release Point	B_{rpS}	1.5	3.0	-	mT	
	B_{rpN}	-	-3.0	-1.5		
Hysteresis	B_{hysS}	-	0.4	-	mT	
	B_{hysN}	-	0.4	-		
Output High Voltage	V_{OH}	4.6	-	-	V	$B_{rpN} < B < B_{rpS}$ $I_{OUT} = -1.0mA$ ※26
Output Low Voltage	V_{OL}	-	-	0.4	V	$B < B_{opN}$, $B_{opS} < B$ $I_{OUT} = +1.0mA$ ※26
Supply Current	I_{DD}	-	2	4	mA	

※26 B = Magnetic flux density

1mT=10Gauss

Positive (“+”) polarity flux is defined as the magnetic flux from south pole which is direct toward to the branded face of the sensor.

Radiation hardness is not designed.

● Figure of measurement circuit

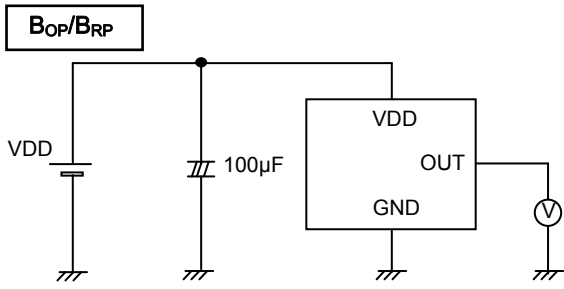

Bop and Brp are measured with applying the magnetic field from the outside.

Fig.1 B_{op}, B_{rp} measurement circuit

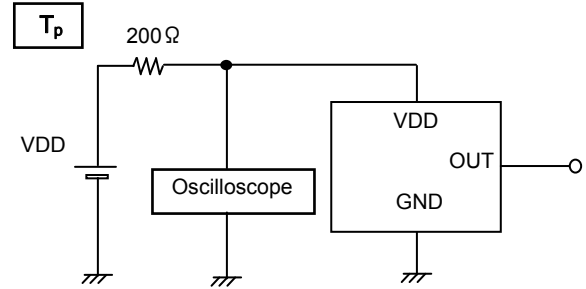

The period is monitored by Oscilloscope.

Fig.2 T_p measurement circuit

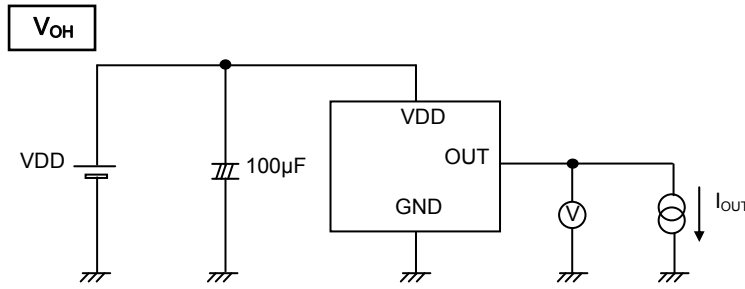

Fig.3 V_{OH} measurement circuit

Product Name	I _{OUT}
BU52001GUL, BU52021HFV, BU52025G, BD7411G	1.0mA
BU52054GWZ, BU52055GWZ, BU52015GUL, BU52061NVX, BU52053NVX, BU52056NVX, BU52011HFV	0.5mA

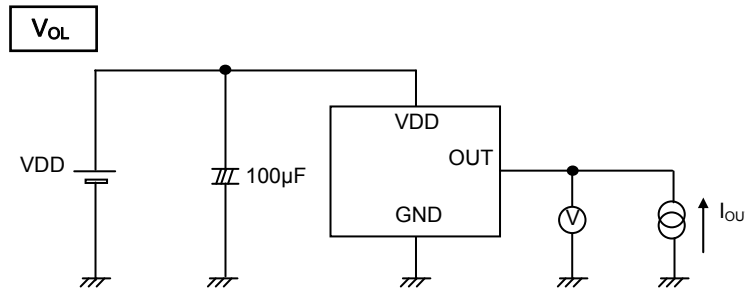

Fig.4 V_{OL} measurement circuit

Product Name	I _{OUT}
BU52001GUL, BU52021HFV, BU52025G, BD7411G	1.0mA
BU52054GWZ, BU52055GWZ, BU52015GUL, BU52061NVX, BU52053NVX, BU52056NVX, BU52011HFV	0.5mA

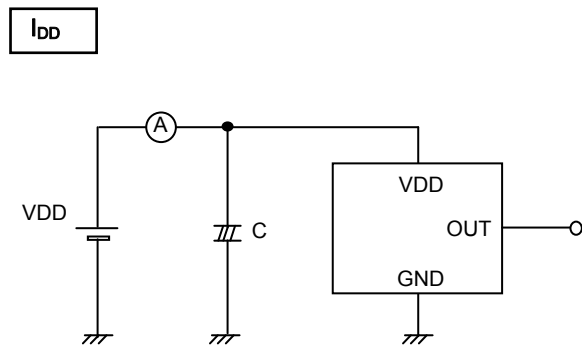

Fig.5 I_{DD} measurement circuit

Product Name	C
BU52054GWZ, BU52055GWZ, BU52015GUL, BU52001GUL, BU52061NVX, BU52053NVX, BU52056NVX, BU52011HFV, BU52021HFV, BU52025G	2200µF
BD7411G	100µF

● Technical (Reference) Data

BU52054GWZ (V_{DD}=1.65~3.6V type)

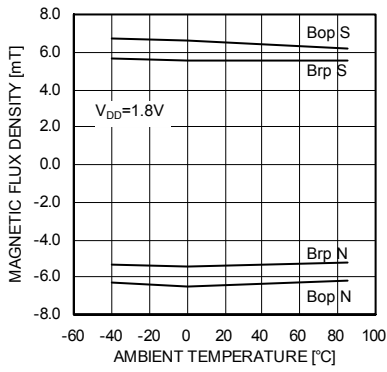

Fig. 6 Bop, Brp– Ambient temperature

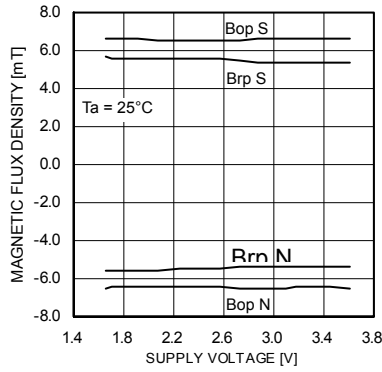

Fig. 7 Bop, Brp– Supply voltage

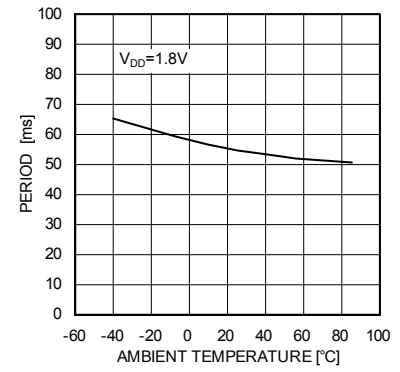

Fig. 8 T_P– Ambient temperature

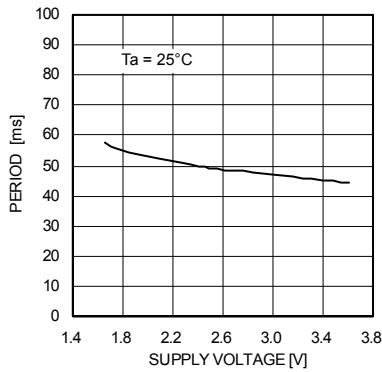

Fig. 9 T_P– Supply voltage

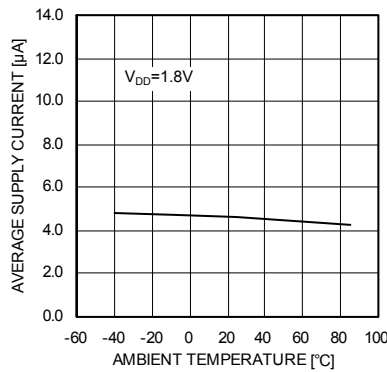

Fig. 10 I_{DD}– Ambient temperature

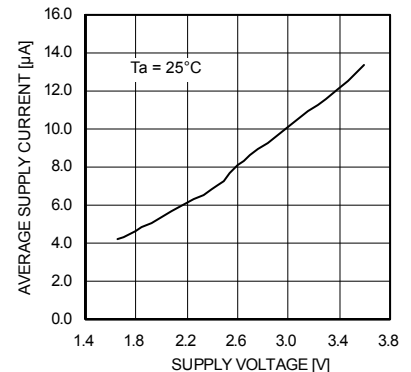

Fig. 11 I_{DD}– Supply voltage

BU52055GWZ (V_{DD}=1.65~3.6V type)

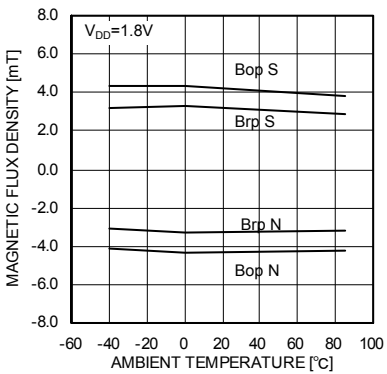

Fig. 12 Bop, Brp– Ambient temperature

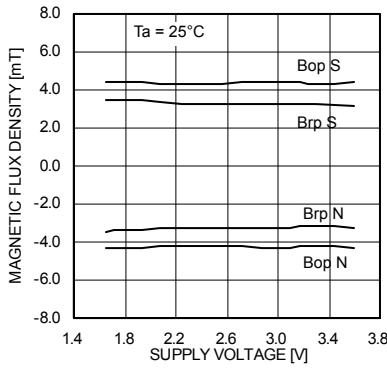

Fig. 13 Bop, Brp– Supply voltage

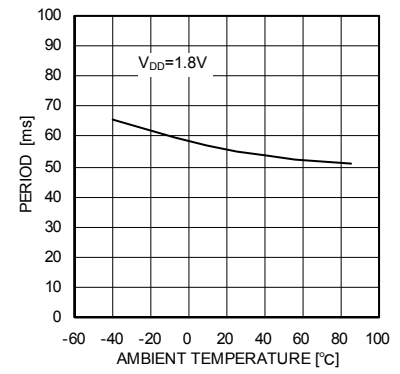

Fig. 14 T_P– Ambient temperature

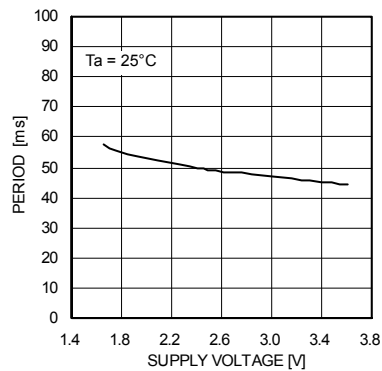

Fig. 15 T_P– Supply voltage

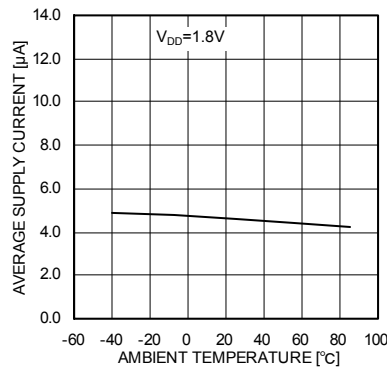

Fig. 16 I_{DD}– Ambient temperature

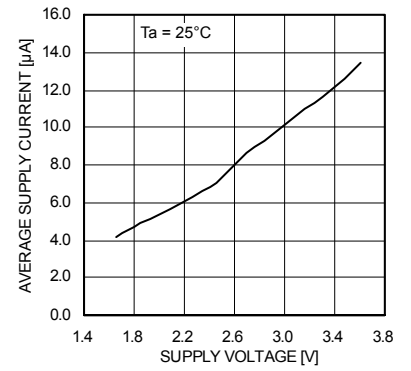

Fig. 17 I_{DD}– Supply voltage

BU52015GUL, BU52011HFV ($V_{DD}=1.65\sim 3.3V$ type)

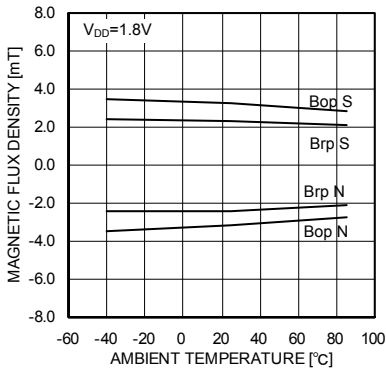

Fig. 18 Bop, Brp– Ambient temperature

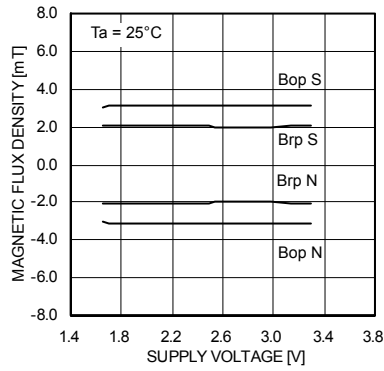

Fig. 19 Bop, Brp Supply voltage

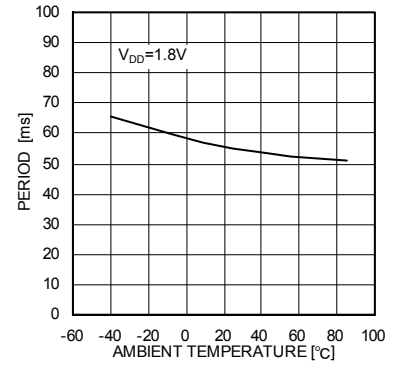

Fig. 20 T_P – Ambient temperature

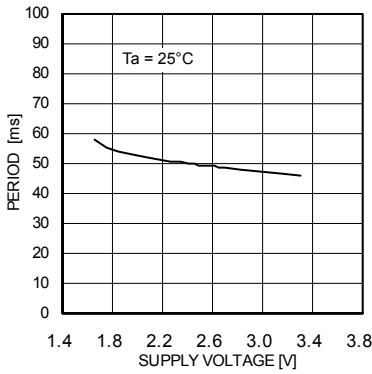

Fig. 21 T_P – Supply voltage

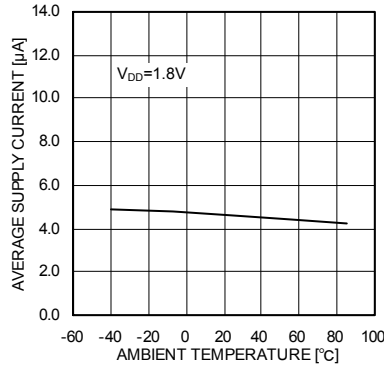

Fig. 22 I_{DD} – Ambient temperature

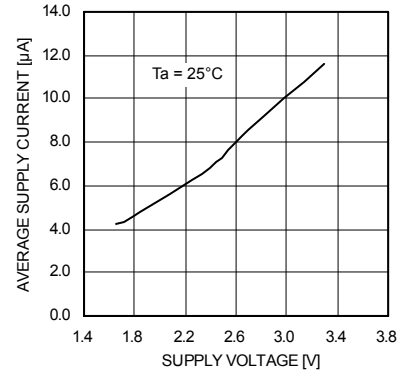

Fig. 23 I_{DD} – Supply voltage

BU52001GUL ($V_{DD}=2.4\sim 3.3V$ type)

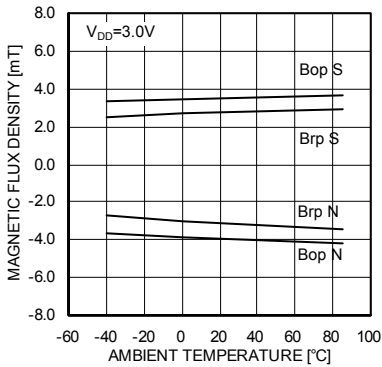

Fig. 24 Bop, Brp– Ambient temperature

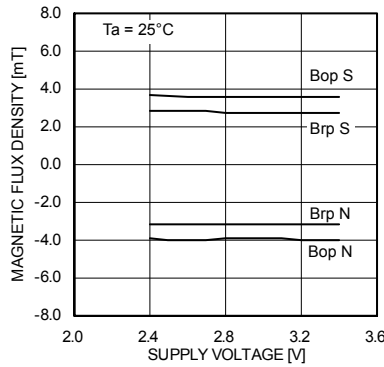

Fig. 25 Bop, Brp– Supply voltage

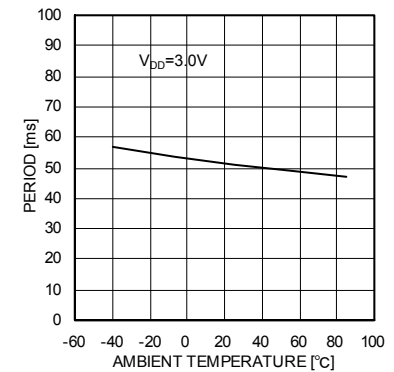

Fig. 26 T_P – Ambient temperature

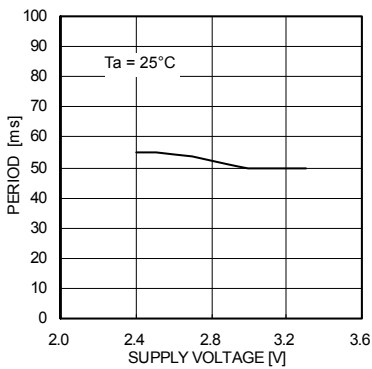

Fig. 27 T_P – Supply voltage

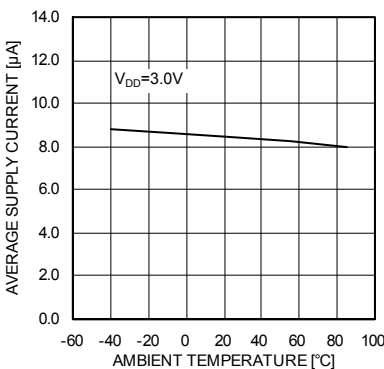

Fig. 28 I_{DD} – Ambient temperature

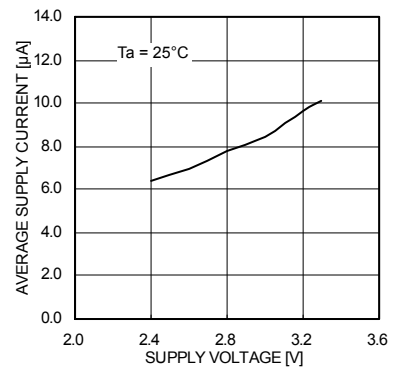

Fig. 29 I_{DD} – Supply voltage

BU52061NVX (V_{DD}=1.65~3.6V type)

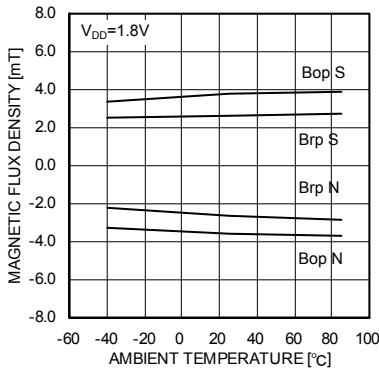

Fig.30 Bop,Brp- Ambient temperature

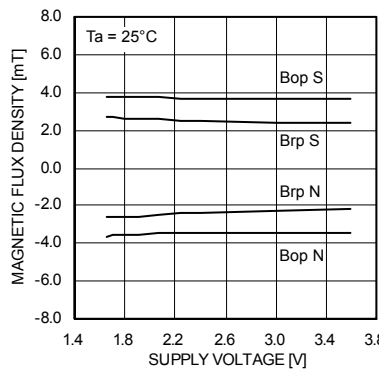

Fig.31 Bop,Brp- Supply voltage

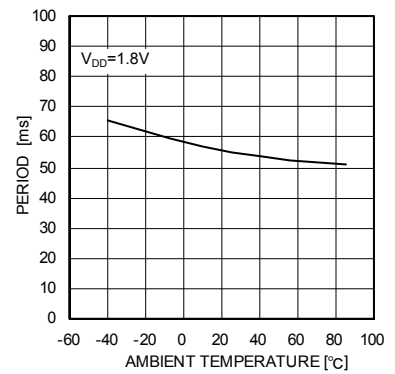

Fig.32 T_P - Ambient temperature

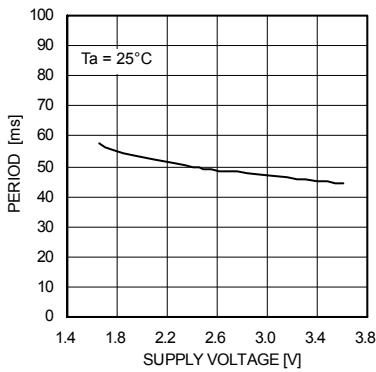

Fig.33 T_P- Supply voltage

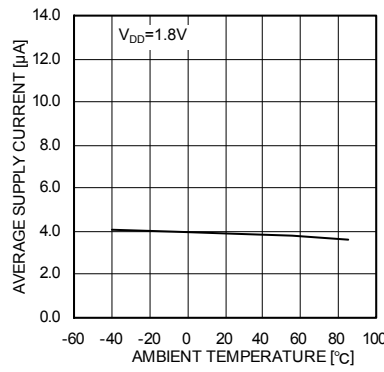

Fig.34 I_{DD}- Ambient temperature

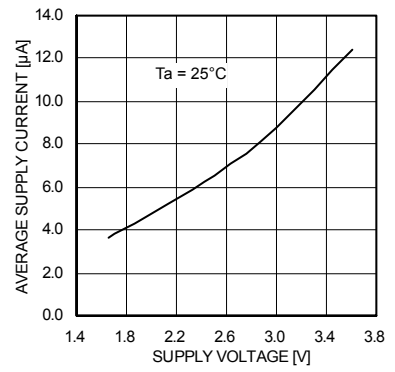

Fig.35 I_{DD} - Supply voltage

BU52053NVX (V_{DD}=1.65~3.6V type)

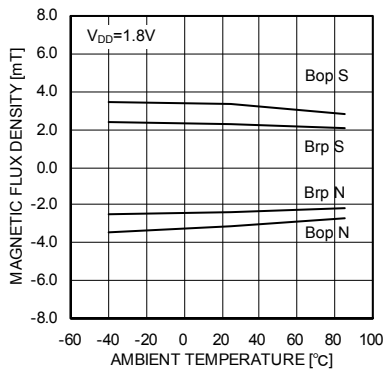

Fig.36 Bop,Brp- Ambient temperature

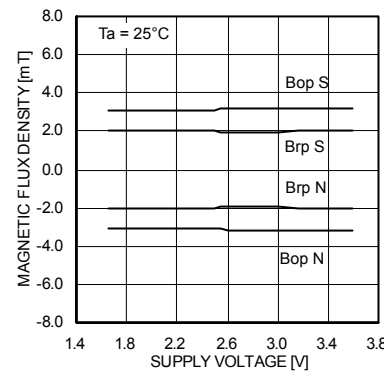

Fig.37 Bop,Brp- Supply voltage

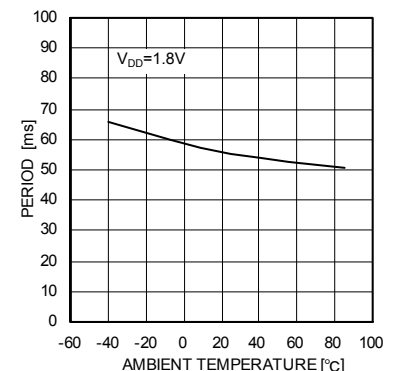

Fig.38 T_P - Ambient temperature

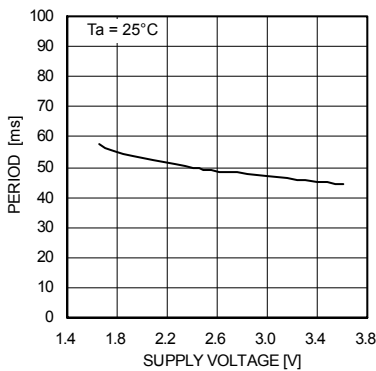

Fig.39 T_P- Supply voltage

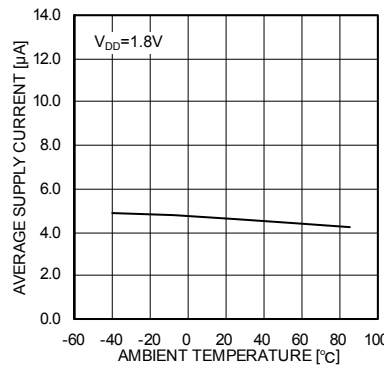

Fig.40 I_{DD}- Ambient temperature

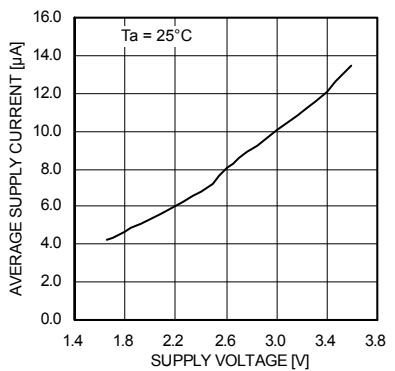

Fig.41 I_{DD} - Supply voltage

BU52056NVX (V_{DD}=1.65~3.6V type)

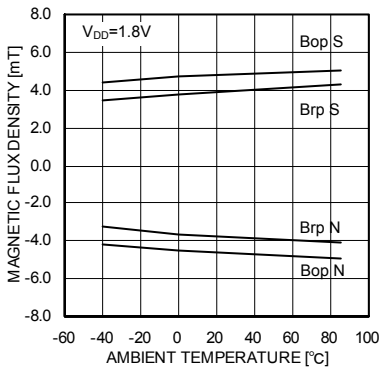

Fig.42 Bop, Brp – Ambient temperature

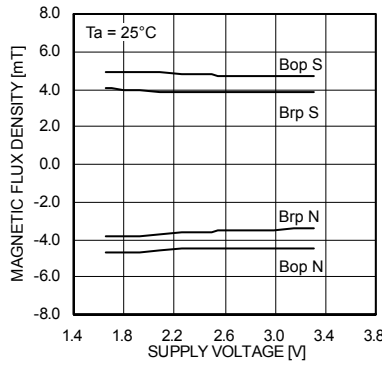

Fig.43 Bop, Brp – Supply voltage

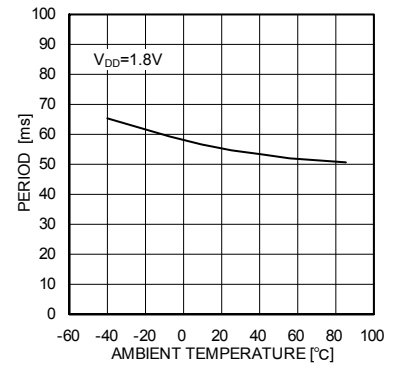

Fig.44 T_P – Ambient temperature

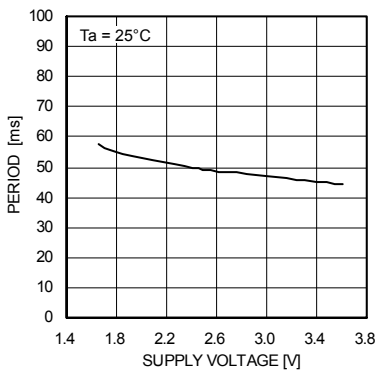

Fig.45 T_P – Supply voltage

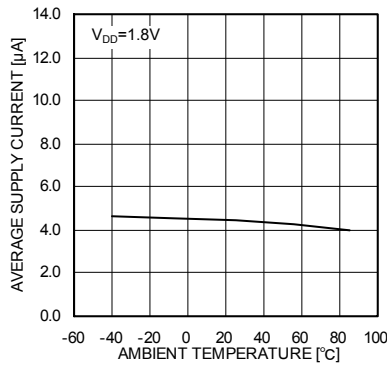

Fig.46 I_{DD} – Ambient temperature

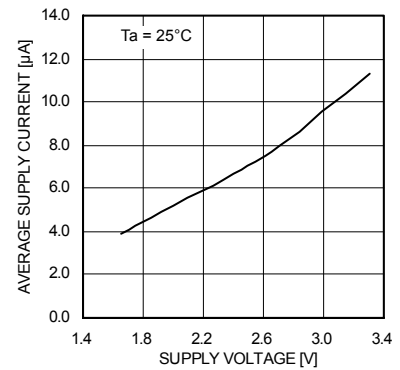

Fig.47 I_{DD} – Supply voltage

BU52021HFV, BU52025G (V_{DD}=2.4~3.6V type)

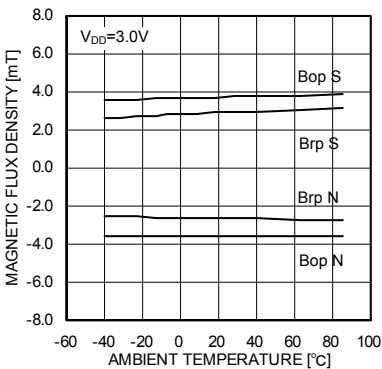

Fig.48 Bop, Brp – Ambient temperature

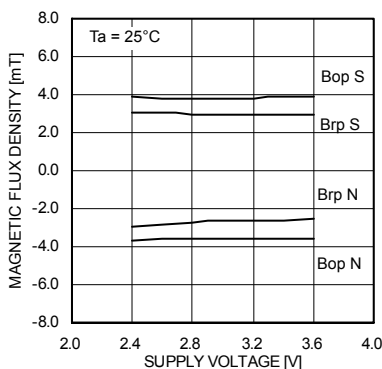

Fig.49 Bop, Brp – Supply voltage

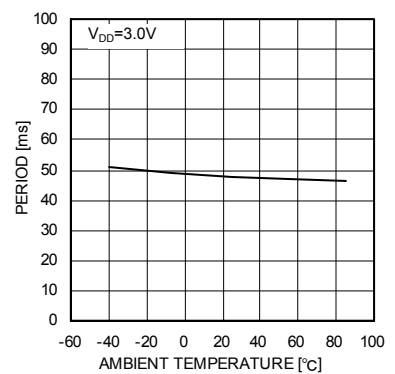

Fig.50 T_P – Ambient temperature

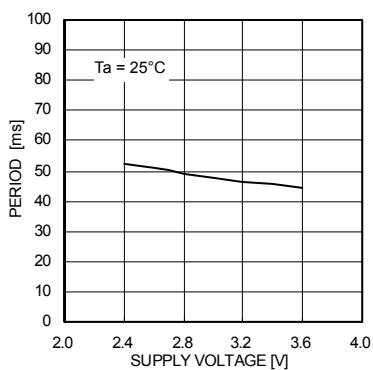

Fig.51 T_P – Supply voltage

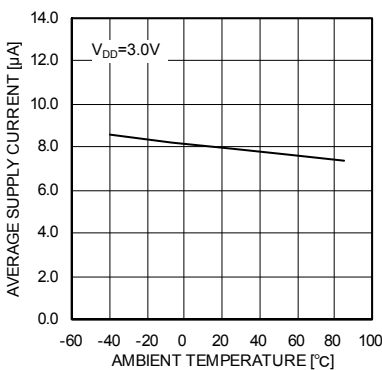

Fig.52 I_{DD} – Ambient temperature

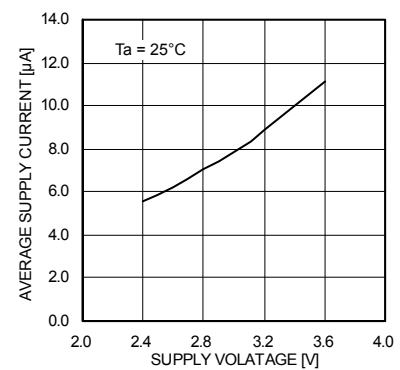

Fig.53 I_{DD} – Supply voltage

BD7411G (V_{DD}=4.5~5.5V type)

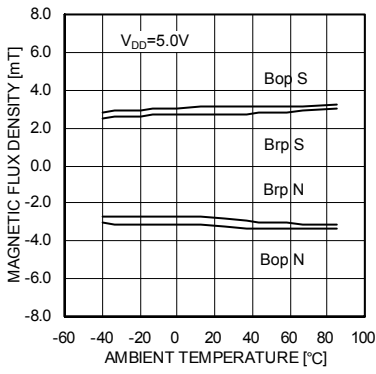

Fig.54 Bop,Brp–Ambient temperature

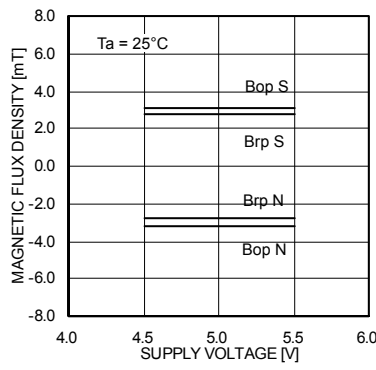

Fig.55 Bop,Brp– Supply voltage

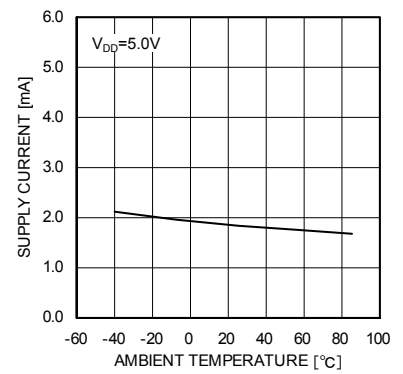

Fig.56 I_{DD} – Ambient temperature

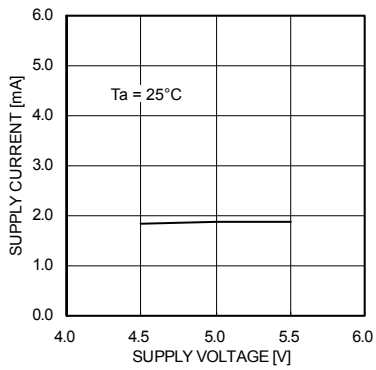
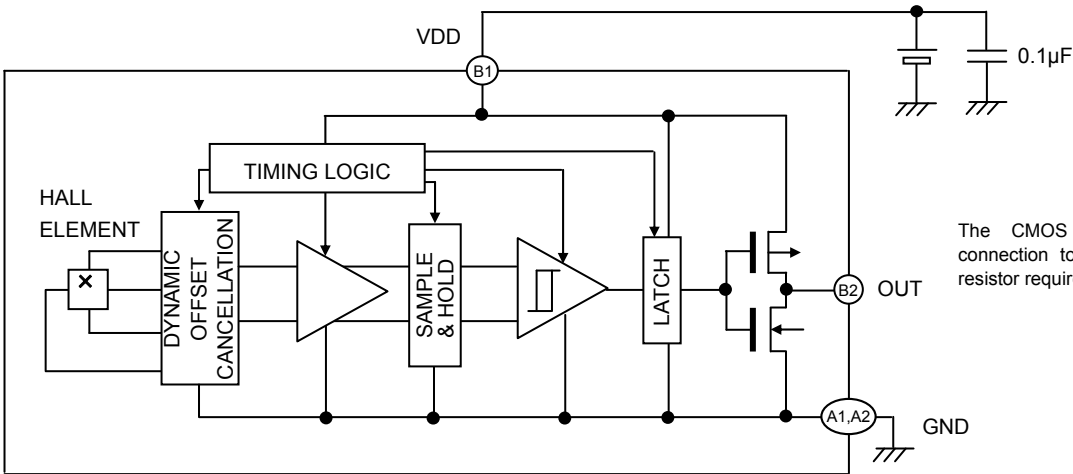

Fig.57 I_{DD} – Supply voltage

● Block Diagram

BU52054GWZ, BU52055GWZ



Adjust the bypass capacitor value as necessary, according to voltage noise conditions, etc.

The CMOS output terminals enable direct connection to the PC, with no external pull-up resistor required.

Fig.58

PIN No.	PIN NAME	FUNCTION	COMMENT
A1	GND	GROUND	
A2	GND	GROUND	
B1	VDD	POWER SUPPLY	
B2	OUT	OUTPUT	

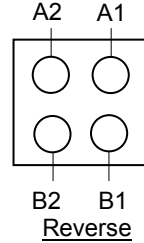
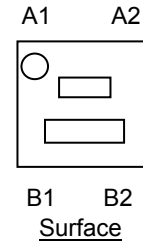

BU52015GUL

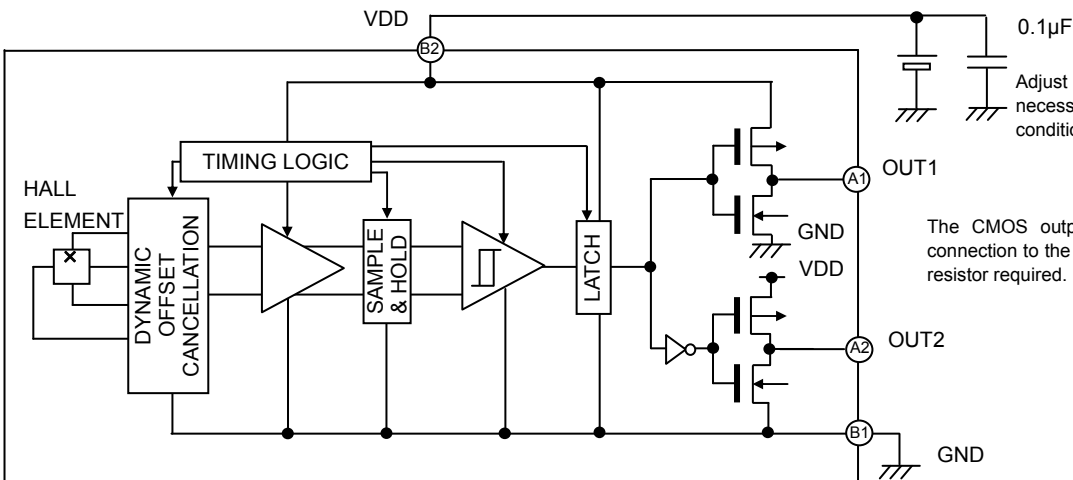

Adjust the bypass capacitor value as necessary, according to voltage noise conditions, etc.

The CMOS output terminals enable direct connection to the PC, with no external pull-up resistor required.

Fig.59

PIN No.	PIN NAME	FUNCTION	COMMENT
A1	OUT1	Output pin (Active Low)	
A2	OUT2	Output pin (Active High)	
B1	GND	GROUND	
B2	VDD	Power Supply Voltage	

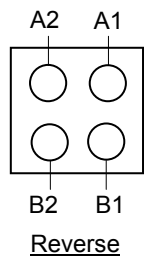
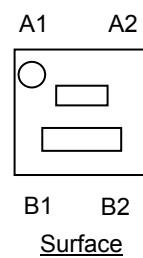

BU52001GUL

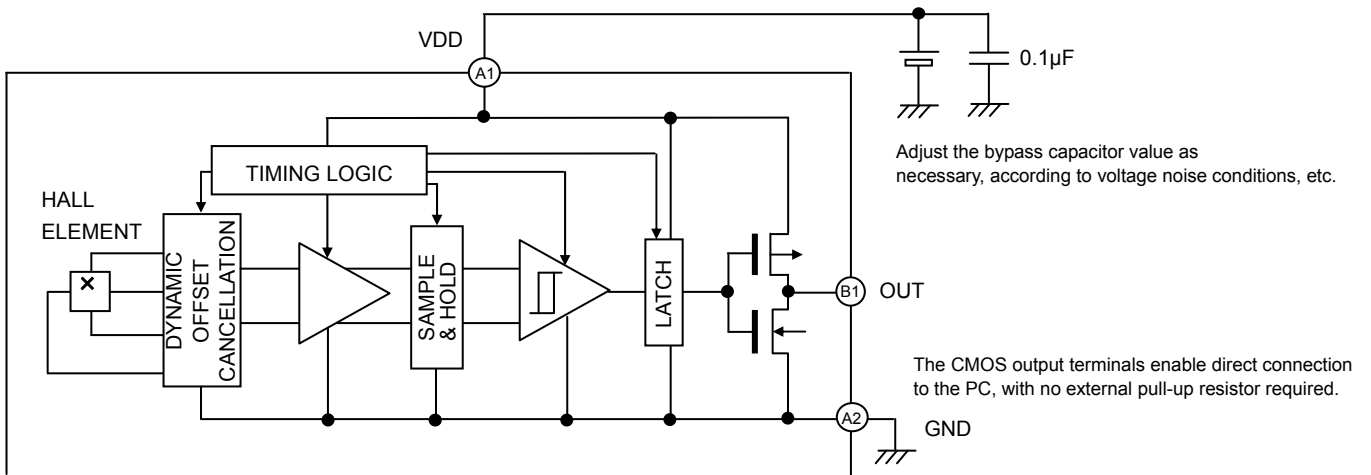
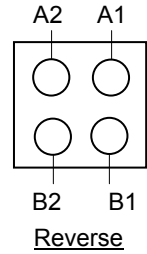
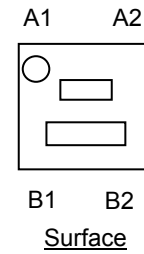

Fig.60

PIN No.	PIN NAME	FUNCTION	COMMENT
A1	VDD	POWER SUPPLY	
A2	GND	GROUND	
B1	OUT	OUTPUT	
B2	N.C.		OPEN or Short to GND.



BU52061NVX, BU52053NVX, BU52056NVX

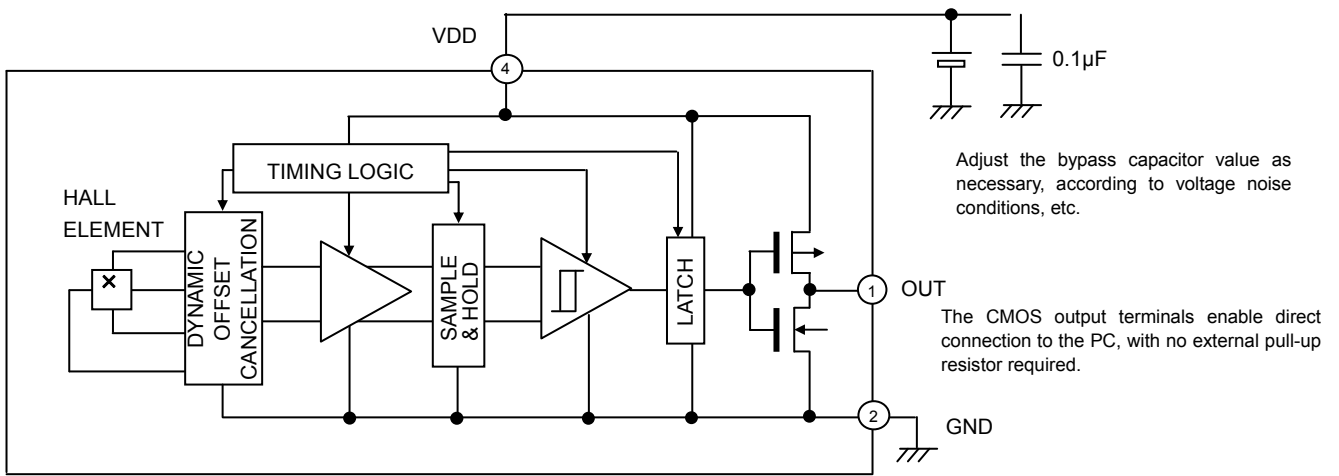
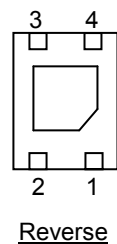
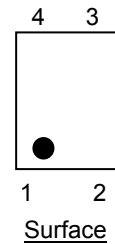

Fig.61

PIN No.	PIN NAME	FUNCTION	COMMENT
1	OUT	OUTPUT	
2	GND	GROUND	
3	N.C.		OPEN or Short to GND.
4	VDD	POWER SUPPLY	



BU52011HFV, BU52021HFV

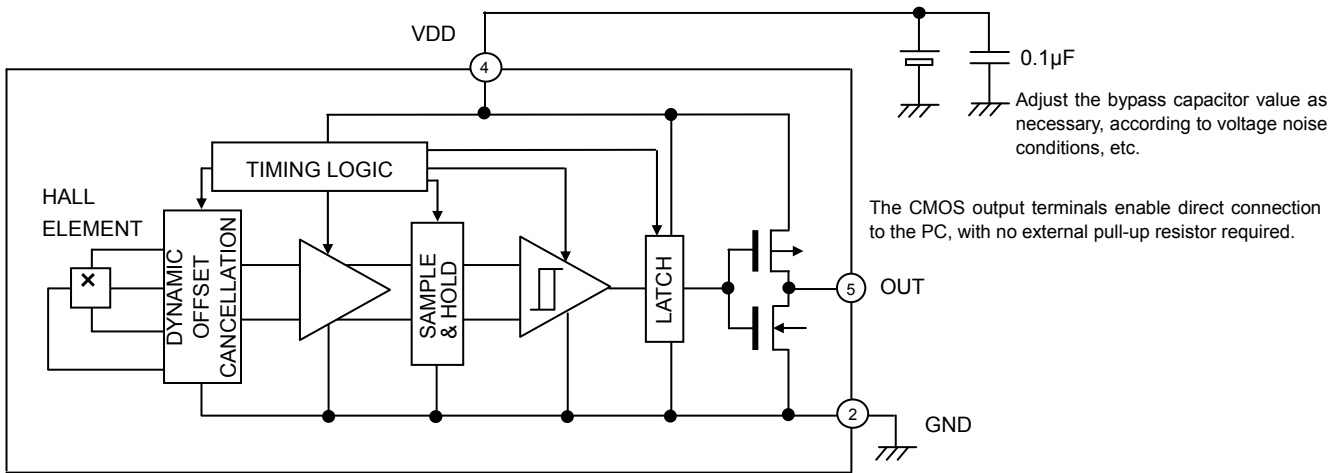
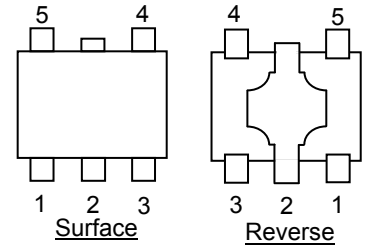

Fig.62

PIN No.	PIN NAME	FUNCTION	COMMENT
1	N.C.		OPEN or Short to GND.
2	GND	GROUND	
3	N.C.		OPEN or Short to GND.
4	VDD	POWER SUPPLY	
5	OUT	OUTPUT	



BU52025G

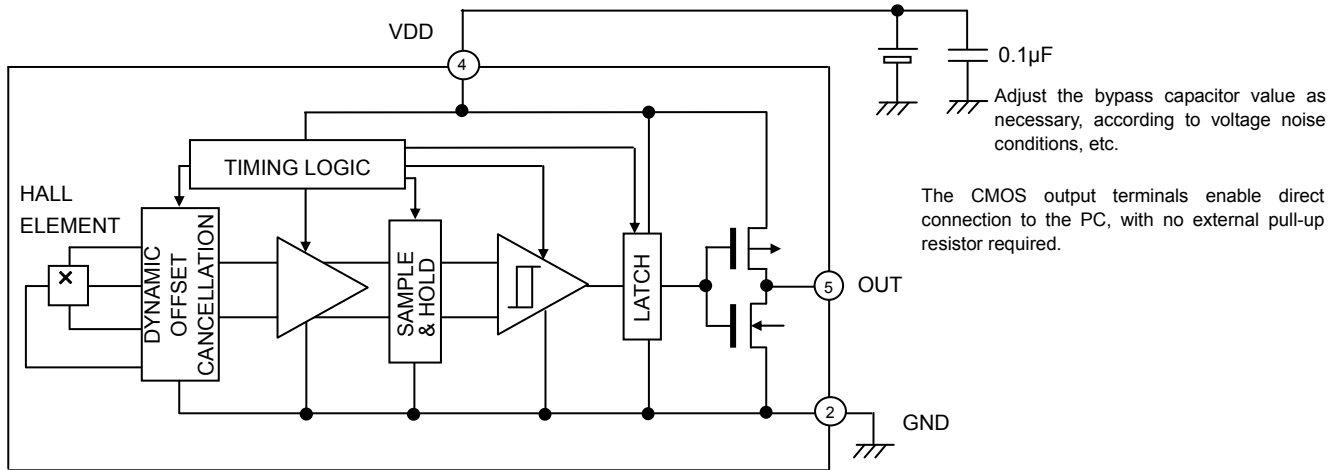
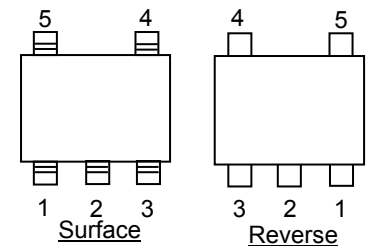

Fig.63

PIN No.	PIN NAME	FUNCTION	COMMENT
1	N.C.		OPEN or Short to GND.
2	GND	GROUND	
3	N.C.		OPEN or Short to GND.
4	VDD	POWER SUPPLY	
5	OUT	OUTPUT	



BD7411G

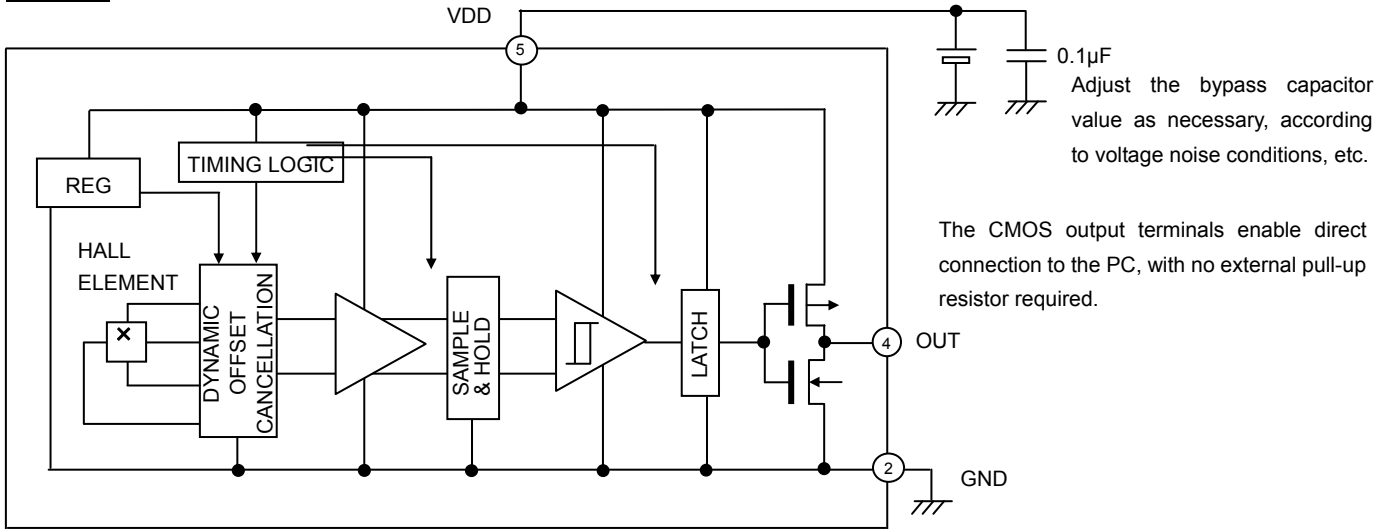
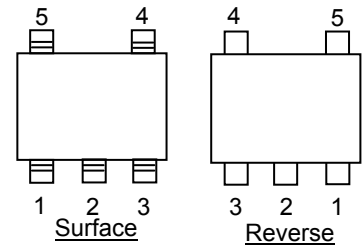

Fig.64

PIN No.	PIN NAME	FUNCTION	COMMENT
1	N.C.		OPEN or Short to GND.
2	GND	GROUND	
3	N.C.		OPEN or Short to GND.
4	OUT	OUTPUT	
5	VDD	POWER SUPPLY	



●Description of Operations

(Micropower Operation)

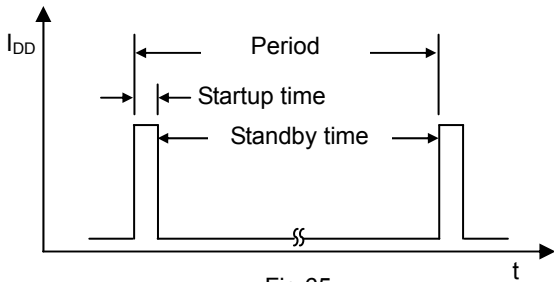

Fig.65

The bipolar detection Hall IC adopts an intermittent operation method to save energy. At startup, the Hall elements, amp, comparator and other detection circuits power ON and magnetic detection begins. During standby, the detection circuits power OFF, thereby reducing current consumption. The detection results are held while standby is active, and then output.

Reference period: 50ms (MAX100ms)
 Reference startup time: 48 μ s

※BD7411G don't adopts an intermittent operation method.

(Offset Cancellation)

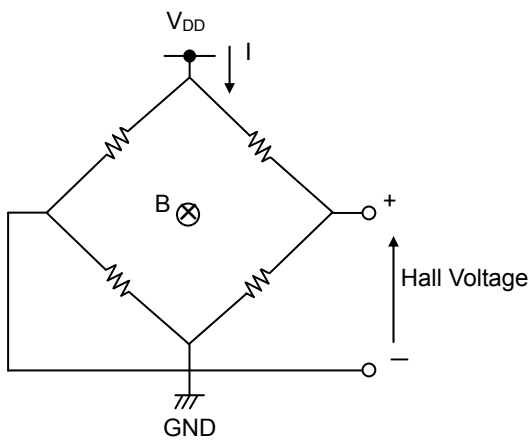

Fig.66

The Hall elements form an equivalent Wheatstone (resistor) bridge circuit. Offset voltage may be generated by a differential in this bridge resistance, or can arise from changes in resistance due to package or bonding stress. A dynamic offset cancellation circuit is employed to cancel this offset voltage.

When Hall elements are connected as shown in Fig. 66 and a magnetic field is applied perpendicular to the Hall elements, voltage is generated at the mid-point terminal of the bridge. This is known as Hall voltage.

Dynamic cancellation switches the wiring (shown in the figure) to redirect the current flow to a 90° angle from its original path, and thereby cancels the Hall voltage.

The magnetic signal (only) is maintained in the sample/hold circuit during the offset cancellation process and then released.

(Magnetic Field Detection Mechanism)

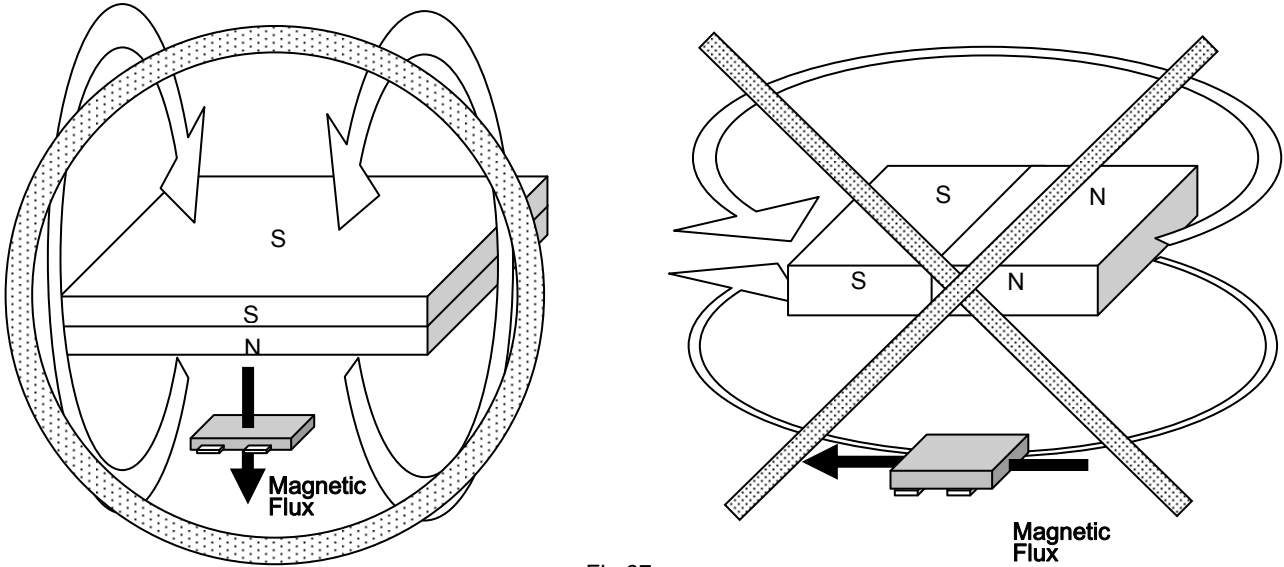

Fig.67

The Hall IC cannot detect magnetic fields that run horizontal to the package top layer. Be certain to configure the Hall IC so that the magnetic field is perpendicular to the top layer.

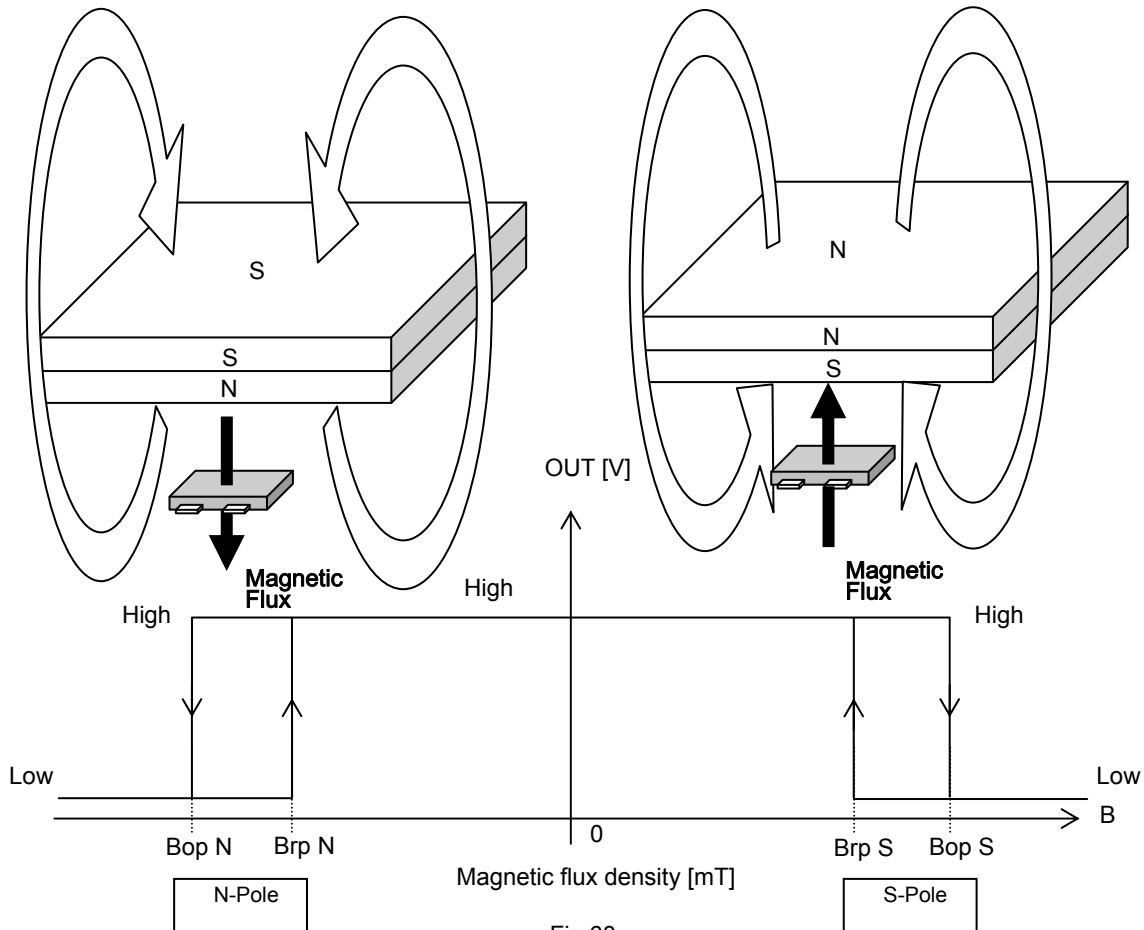

Fig.68

The bipolar detection Hall IC detects magnetic fields running perpendicular to the top surface of the package. There is an inverse relationship between magnetic flux density and the distance separating the magnet and the Hall IC: when distance increases magnetic density falls. When it drops below the operate point (Bop), output goes HIGH. When the magnet gets closer to the IC and magnetic density rises, to the operate point, the output switches LOW. In LOW output mode, the distance from the magnet to the IC increases again until the magnetic density falls to a point just below Bop, and output returns HIGH. (This point, where magnetic flux density restores HIGH output, is known as the release point, Brp.) This detection and adjustment mechanism is designed to prevent noise, oscillation and other erratic system operation.

● Intermittent Operation at Power ON
Power ON

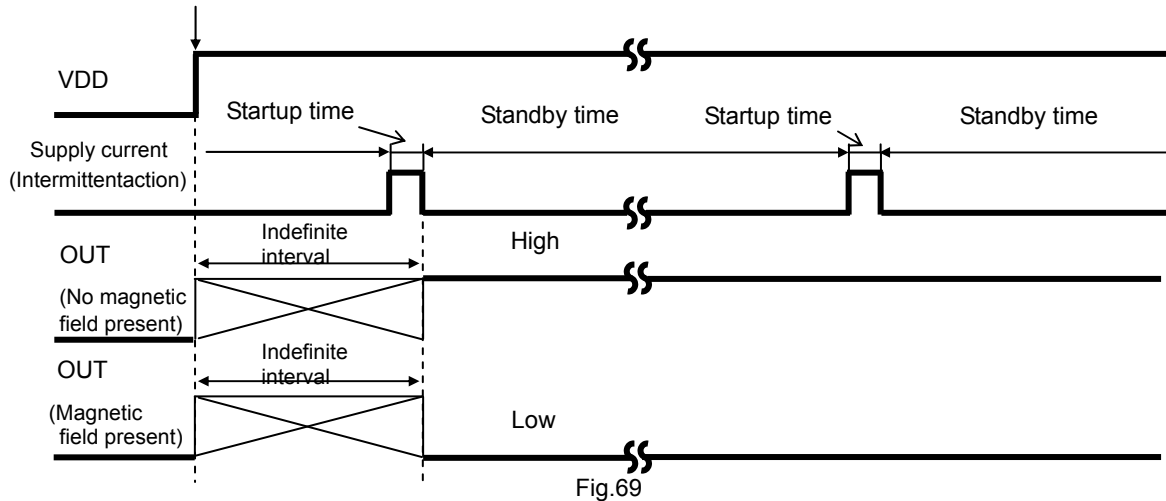

Fig.69

The bipolar detection Hall IC adopts an intermittent operation method in detecting the magnetic field during startup, as shown in Fig. 69. It outputs to the appropriate terminal based on the detection result and maintains the output condition during the standby period. The time from power ON until the end of the initial startup period is an indefinite interval, but it cannot exceed the maximum period, 100ms. To accommodate the system design, the Hall IC output read should be programmed within 100ms of power ON, but after the time allowed for the period ambient temperature and supply voltage. ※BD7411G don't adopts an intermittent operation method.

● Magnet Selection

Of the two representative varieties of permanent magnet, neodymium generally offers greater magnetic power per volume than ferrite, thereby enabling the highest degree of miniaturization. Thus, neodymium is best suited for small equipment applications. Fig. 70 shows the relation between the size (volume) of a neodymium magnet and magnetic flux density. The graph plots the correlation between the distance (L) from three versions of a 4mm X 4mm cross-section neodymium magnet (1mm, 2mm, and 3mm thick) and magnetic flux density. Fig. 71 shows Hall IC detection distance – a good guide for determining the proper size and detection distance of the magnet. Based on the BU52011HFV, BU52015GUL operating point max 5.0 mT, the minimum detection distance for the 1mm, 2mm and 3mm magnets would be 7.6mm, 9.22mm, and 10.4mm, respectively. To increase the magnet's detection distance, either increase its thickness or sectional area.

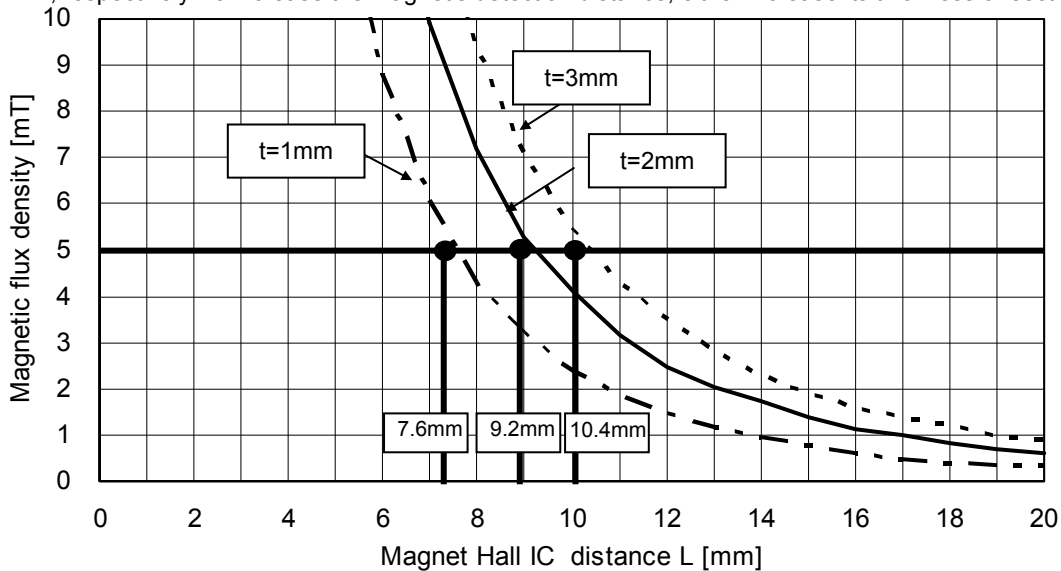
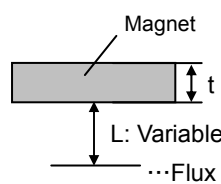
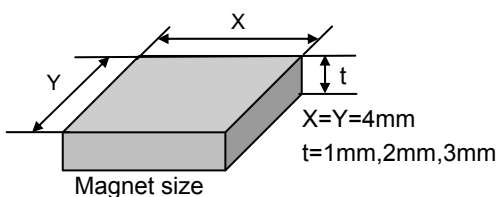

Fig.70



Magnet material: NMX-44CH
Maker: Hitachi Metals.,LTD

...Flux density measuring point

Fig.71 Magnet Dimensions and Flux Density Measuring Point

●Position of the Hall Effect IC(Reference)

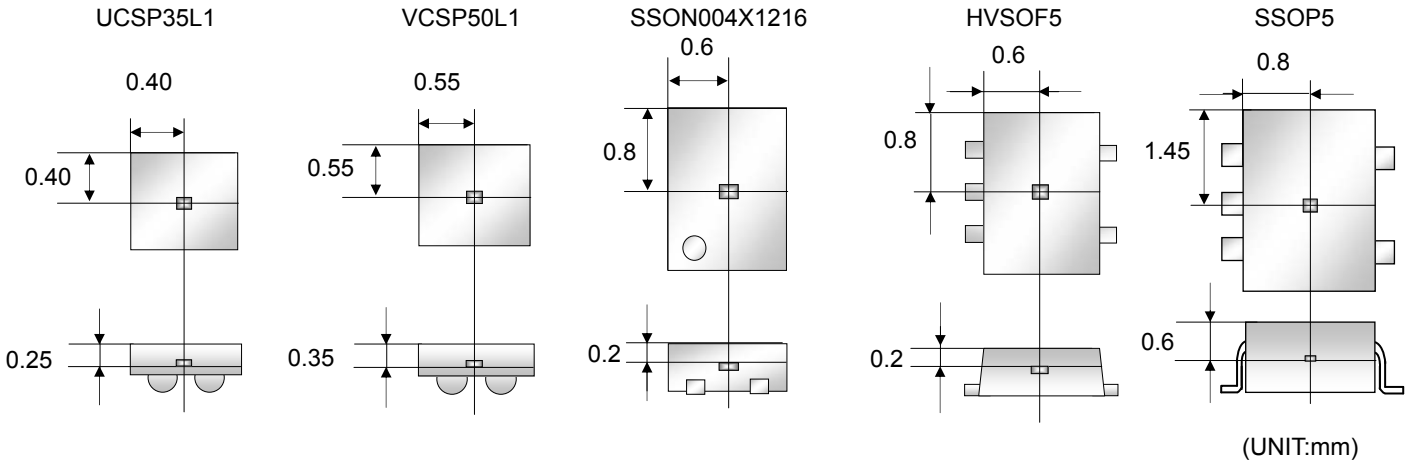

●Footprint dimensions (Optimize footprint dimensions to the board design and soldering condition)

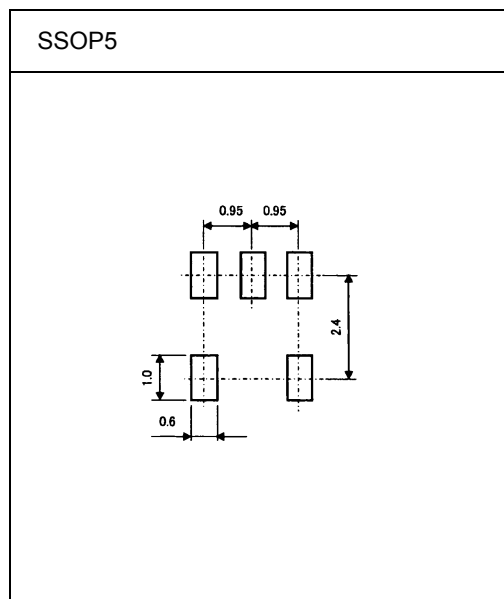
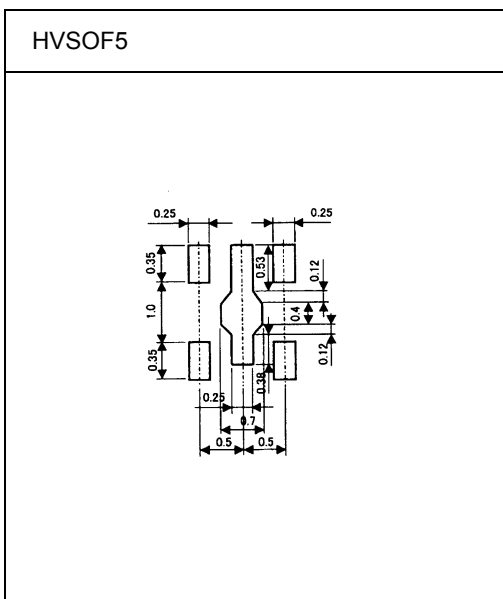
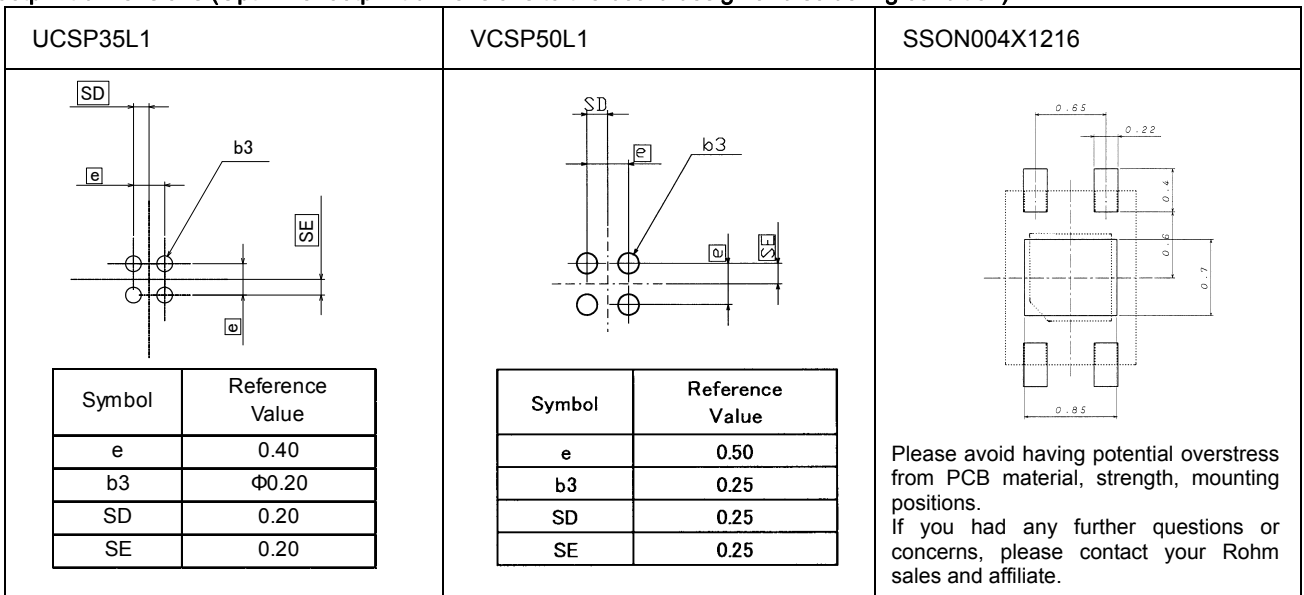

(UNIT:mm)

● Terminal Equivalent Circuit Diagram

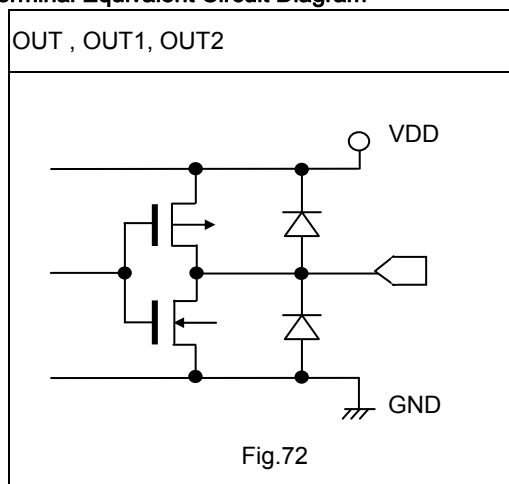

Because they are configured for CMOS (inverter) output, the output pins require no external resistance and allow direct connection to the PC. This, in turn, enables reduction of the current that would otherwise flow to the external resistor during magnetic field detection, and supports overall low current (micropower) operation.

● Notes for use

- 1) Absolute maximum ratings
 Exceeding the absolute maximum ratings for supply voltage, operating conditions, etc. may result in damage to or destruction of the IC. Because the source (short mode or open mode) cannot be identified if the device is damaged in this way, it is important to take physical safety measures such as fusing when implementing any special mode that operates in excess of absolute rating limits.
- 2) GND voltage
 Make sure that the GND terminal potential is maintained at the minimum in any operating state, and is always kept lower than the potential of all other pins.
- 3) Thermal design
 Use a thermal design that allows for sufficient margin in light of the power dissipation (Pd) in actual operating conditions.
- 4) Pin shorts and mounting errors
 Use caution when positioning the IC for mounting on printed circuit boards. Mounting errors, such as improper positioning or orientation, may damage or destroy the device. The IC may also be damaged or destroyed if output pins are shorted together, or if shorts occur between the output pin and supply pin or GND.
- 5) Positioning components in proximity to the Hall IC and magnet
 Positioning magnetic components in close proximity to the Hall IC or magnet may alter the magnetic field, and therefore the magnetic detection operation. Thus, placing magnetic components near the Hall IC and magnet should be avoided in the design if possible. However, where there is no alternative to employing such a design, be sure to thoroughly test and evaluate performance with the magnetic component(s) in place to verify normal operation before implementing the design.
- 6) Slide-by position sensing
 Fig.73 depicts the slide-by configuration employed for position sensing. Note that when the gap (d) between the magnet and the Hall IC is narrowed, the reverse magnetic field generated by the magnet can cause the IC to malfunction. As seen in Fig.74, the magnetic field runs in opposite directions at Point A and Point B. Since the bipolar detection Hall IC can detect the S-pole at Point A and the N-pole at Point B, it can wind up switching output ON as the magnet slides by in the process of position detection. Fig. 75 plots magnetic flux density during the magnet slide-by. Although a reverse magnetic field was generated in the process, the magnetic flux density decreased compared with the center of the magnet. This demonstrates that slightly widening the gap (d) between the magnet and Hall IC reduces the reverse magnetic field and prevents malfunctions.

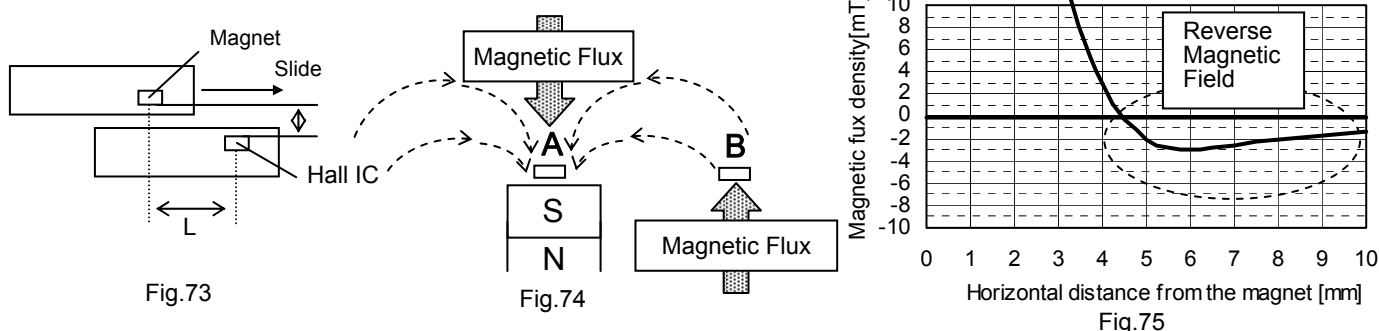

- 7) Operation in strong electromagnetic fields
 Exercise extreme caution about using the device in the presence of a strong electromagnetic field, as such use may cause the IC to malfunction.
- 8) Common impedance
 Make sure that the power supply and GND wiring limits common impedance to the extent possible by, for example, employing short, thick supply and ground lines. Also, take measures to minimize ripple such as using an inductor or capacitor.
- 9) GND wiring pattern
 When both a small-signal GND and high-current GND are provided, single-point grounding at the reference point of the set PCB is recommended, in order to separate the small-signal and high-current patterns, and to ensure that voltage changes due to the wiring resistance and high current do not cause any voltage fluctuation in the small-signal GND. In the same way, care must also be taken to avoid wiring pattern fluctuations in the GND wiring pattern of external components.
- 10) Exposure to strong light
 Exposure to halogen lamps, UV and other strong light sources may cause the IC to malfunction. If the IC is subject to such exposure, provide a shield or take other measures to protect it from the light. In testing, exposure to white LED and fluorescent light sources was shown to have no significant effect on the IC.
- 11) Power source design
 Since the IC performs intermittent operation, it has peak current when it's ON. Please taking that into account and under examine adequate evaluations when designing the power source.

● Ordering part number

B	U	5	2	0	0	1	G	U	L	-	E	2
Part No. BU, BD		Part No. 52054, 52055, 52015 52001, 52061, 52053 52056, 52011, 52021 52025, 7411					Package GWZ : UCSP35L1 GUL : VSCP50L1 NVX : SSON004X1216 HFV : HVSO5F5 G : SSOP5			Packaging and forming specification E2: Embossed tape and reel (UCSP35L1, VSCP50L1) TR: Embossed tape and reel (SSON004X1216, HVSO5F5, SSOP5)		

UCSP35L1(BU52054GWZ)

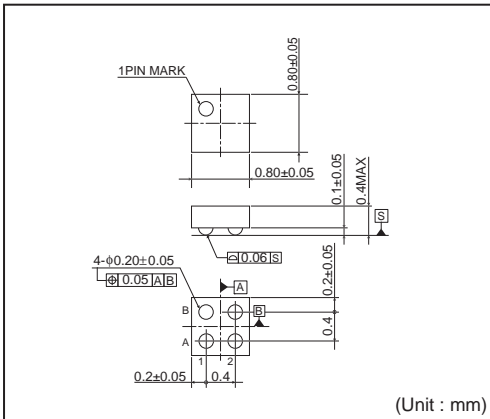

<Tape and Reel information>

Tape	Embossed carrier tape
Quantity	3000pcs
Direction of feed	E2 (The direction is the 1pin of product is at the upper left when you hold reel on the left hand and you pull out the tape on the right hand)

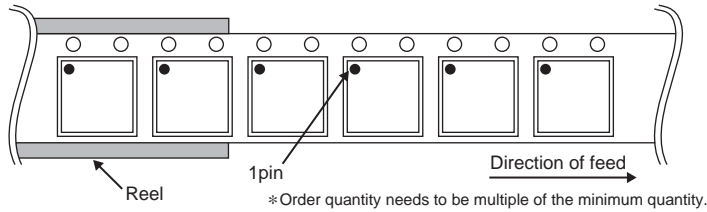

UCSP35L1(BU52055GWZ)

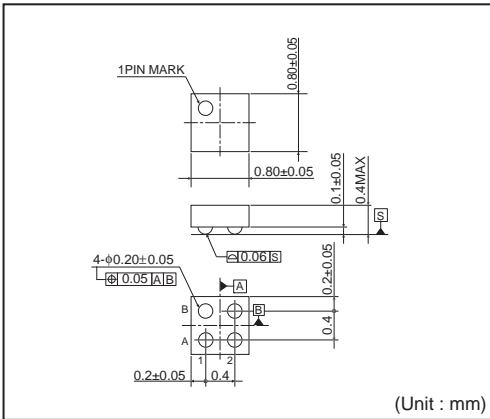

<Tape and Reel information>

Tape	Embossed carrier tape
Quantity	3000pcs
Direction of feed	E2 (The direction is the 1pin of product is at the upper left when you hold reel on the left hand and you pull out the tape on the right hand)

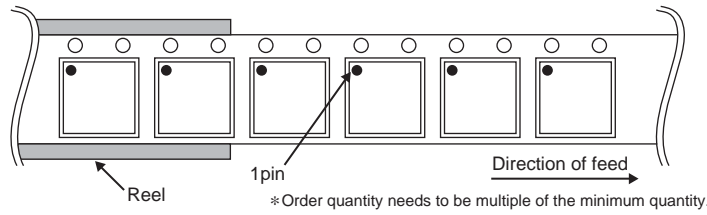

VCSP50L1(BU52015GUL)

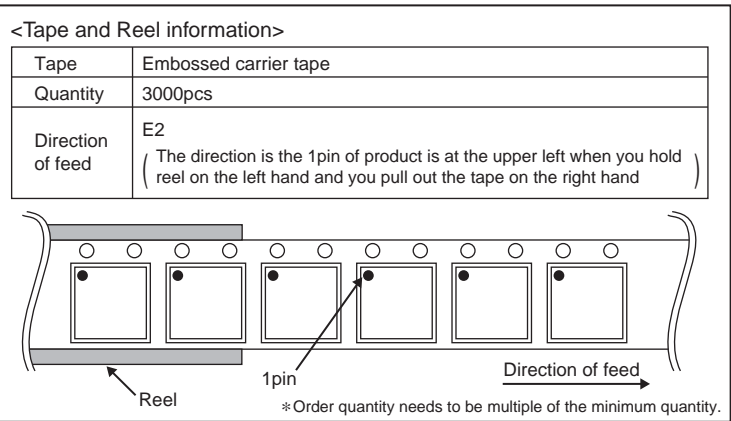
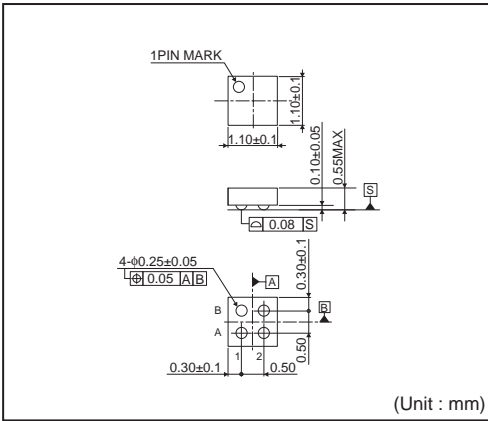

VCSP50L1(BU52001GUL)

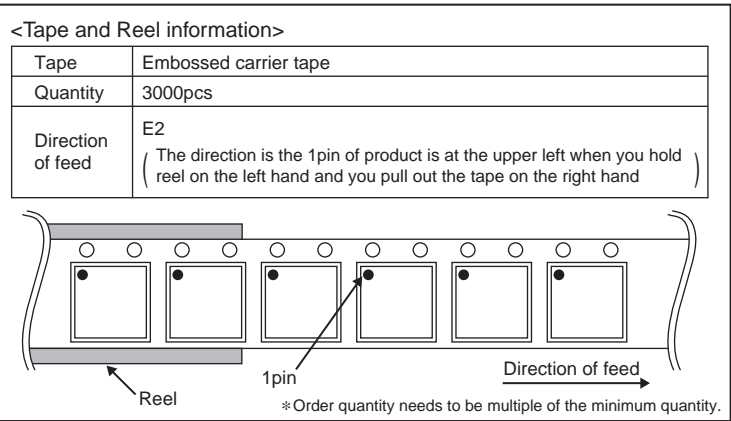
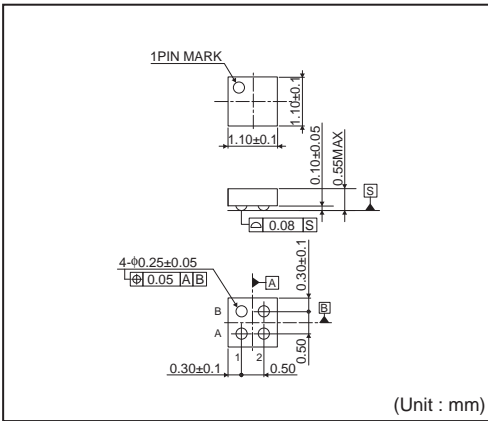

SSON004X1216

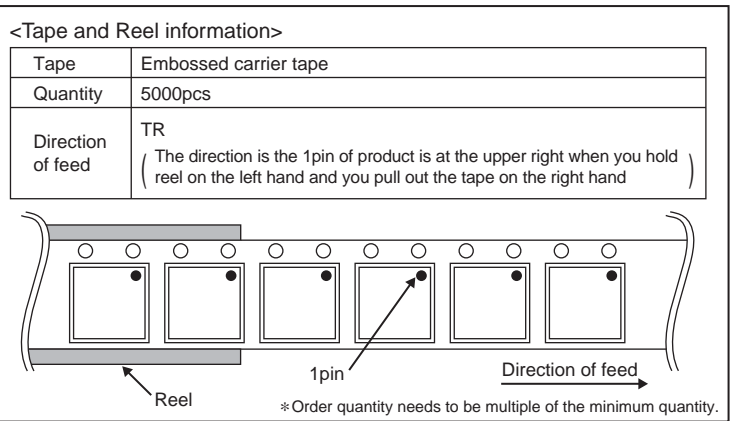
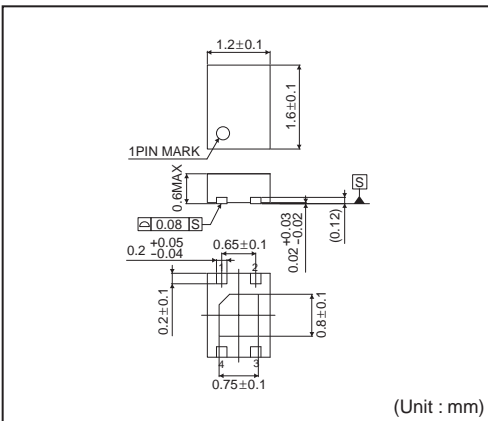

Notes

No copying or reproduction of this document, in part or in whole, is permitted without the consent of ROHM Co.,Ltd.

The content specified herein is subject to change for improvement without notice.

The content specified herein is for the purpose of introducing ROHM's products (hereinafter "Products"). If you wish to use any such Product, please be sure to refer to the specifications, which can be obtained from ROHM upon request.

Examples of application circuits, circuit constants and any other information contained herein illustrate the standard usage and operations of the Products. The peripheral conditions must be taken into account when designing circuits for mass production.

Great care was taken in ensuring the accuracy of the information specified in this document. However, should you incur any damage arising from any inaccuracy or misprint of such information, ROHM shall bear no responsibility for such damage.

The technical information specified herein is intended only to show the typical functions of and examples of application circuits for the Products. ROHM does not grant you, explicitly or implicitly, any license to use or exercise intellectual property or other rights held by ROHM and other parties. ROHM shall bear no responsibility whatsoever for any dispute arising from the use of such technical information.

The Products specified in this document are intended to be used with general-use electronic equipment or devices (such as audio visual equipment, office-automation equipment, communication devices, electronic appliances and amusement devices).

The Products specified in this document are not designed to be radiation tolerant.

While ROHM always makes efforts to enhance the quality and reliability of its Products, a Product may fail or malfunction for a variety of reasons.

Please be sure to implement in your equipment using the Products safety measures to guard against the possibility of physical injury, fire or any other damage caused in the event of the failure of any Product, such as derating, redundancy, fire control and fail-safe designs. ROHM shall bear no responsibility whatsoever for your use of any Product outside of the prescribed scope or not in accordance with the instruction manual.

The Products are not designed or manufactured to be used with any equipment, device or system which requires an extremely high level of reliability the failure or malfunction of which may result in a direct threat to human life or create a risk of human injury (such as a medical instrument, transportation equipment, aerospace machinery, nuclear-reactor controller, fuel-controller or other safety device). ROHM shall bear no responsibility in any way for use of any of the Products for the above special purposes. If a Product is intended to be used for any such special purpose, please contact a ROHM sales representative before purchasing.

If you intend to export or ship overseas any Product or technology specified herein that may be controlled under the Foreign Exchange and the Foreign Trade Law, you will be required to obtain a license or permit under the Law.



Thank you for your accessing to ROHM product informations.
More detail product informations and catalogs are available, please contact us.

ROHM Customer Support System

<http://www.rohm.com/contact/>



Mouser Electronics

Authorized Distributor

Click to View Pricing, Inventory, Delivery & Lifecycle Information:

[ROHM Semiconductor:](#)

[BU52053NVX-TR](#) [BU52056NVX-TR](#)