

CMDSH-4E

**ENHANCED SPECIFICATION
SURFACE MOUNT SILICON
SCHOTTKY DIODE**

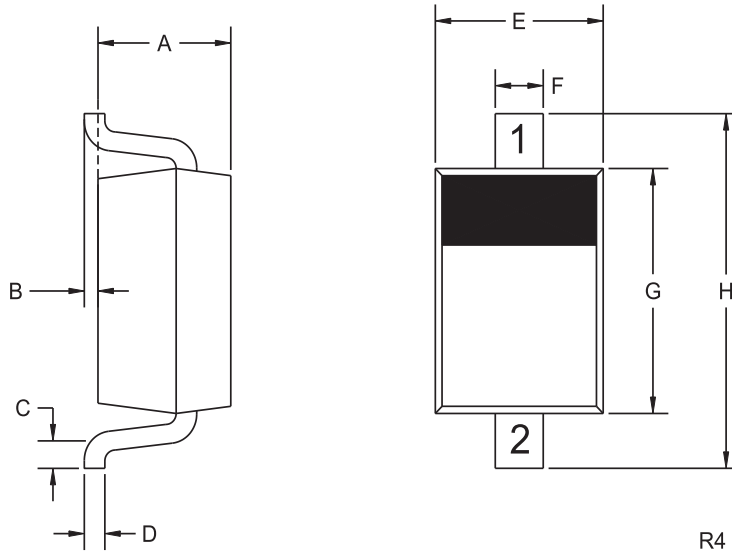

SOD-323 CASE - MECHANICAL OUTLINE



LEAD CODE:

- 1) Cathode
- 2) Anode

MARKING CODE: S1E

DIMENSIONS				
SYMBOL	INCHES		MILLIMETERS	
	MIN	MAX	MIN	MAX
A	0.031	0.039	0.80	1.00
B	0.000	0.004	0.00	0.10
C	0.008	-	0.20	-
D	0.004	0.007	0.11	0.19
E	0.045	0.053	1.15	1.35
F	-	0.014	-	0.35
G	0.063	0.071	1.60	1.80
H	0.094	0.102	2.40	2.60

SOD-323 (REV: R4)

R3 (11-February 2016)

CMDSH-4E

**ENHANCED SPECIFICATION
SURFACE MOUNT SILICON
SCHOTTKY DIODE**



TYPICAL ELECTRICAL CHARACTERISTICS

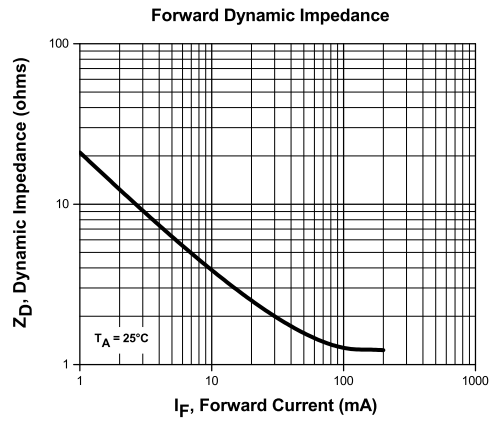
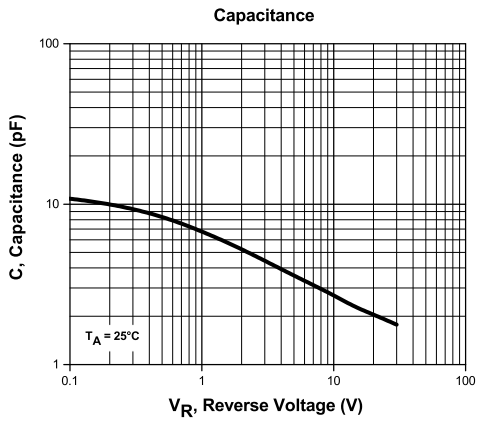
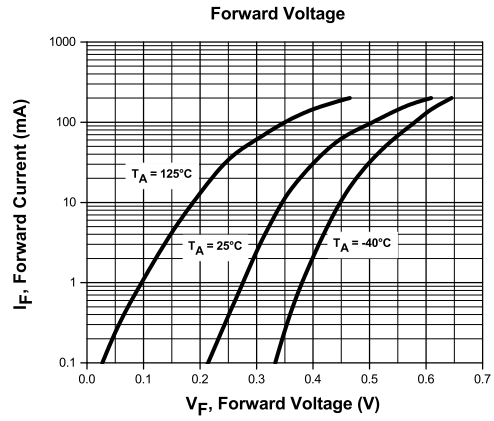
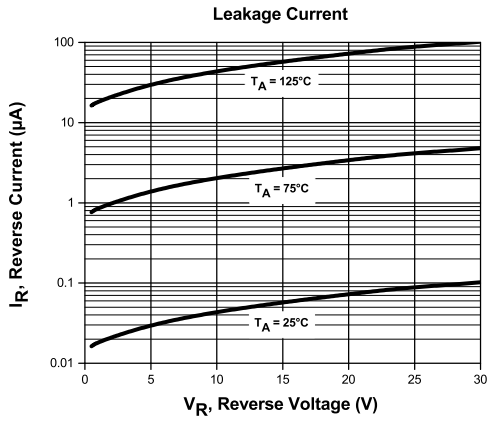

R3 (11-February 2016)

CMDSH-4E

**ENHANCED SPECIFICATION
SURFACE MOUNT SILICON
SCHOTTKY DIODE**



TYPICAL ELECTRICAL CHARACTERISTICS

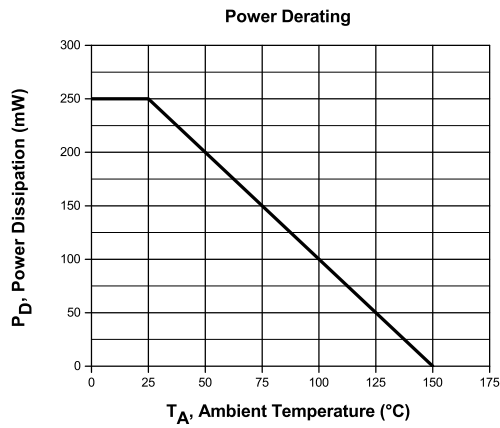
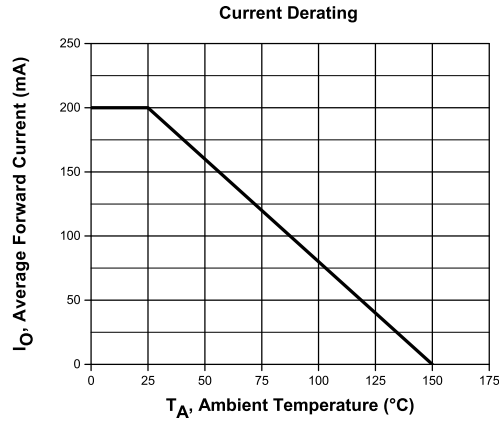
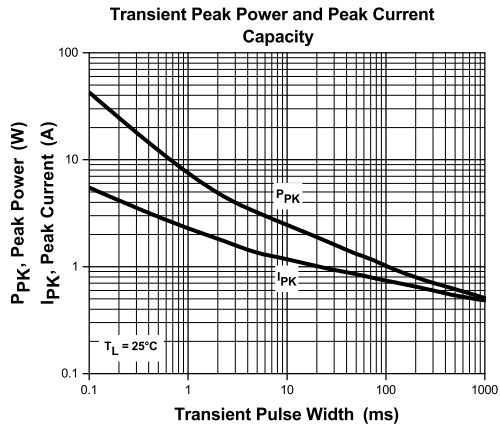

R3 (11-February 2016)

OUTSTANDING SUPPORT AND SUPERIOR SERVICES



PRODUCT SUPPORT

Central's operations team provides the highest level of support to insure product is delivered on-time.

- Supply management (Customer portals)
- Inventory bonding
- Consolidated shipping options
- Custom bar coding for shipments
- Custom product packing

DESIGNER SUPPORT/SERVICES

Central's applications engineering team is ready to discuss your design challenges. Just ask.

- Free quick ship samples (2nd day air)
- Online technical data and parametric search
- SPICE models
- Custom electrical curves
- Environmental regulation compliance
- Customer specific screening
- Up-screening capabilities
- Special wafer diffusions
- PbSn plating options
- Package details
- Application notes
- Application and design sample kits
- Custom product and package development

REQUESTING PRODUCT PLATING

1. If requesting Tin/Lead plated devices, add the suffix " TIN/LEAD" to the part number when ordering (example: 2N2222A TIN/LEAD).
2. If requesting Lead (Pb) Free plated devices, add the suffix " PBFREE" to the part number when ordering (example: 2N2222A PBFREE).

CONTACT US

Corporate Headquarters & Customer Support Team

Central Semiconductor Corp.
145 Adams Avenue
Hauppauge, NY 11788 USA
Main Tel: (631) 435-1110
Main Fax: (631) 435-1824
Support Team Fax: (631) 435-3388
www.centrasemi.com

Worldwide Field Representatives:
www.centrasemi.com/wwreps

Worldwide Distributors:
www.centrasemi.com/wwdistributors

For the latest version of Central Semiconductor's **LIMITATIONS AND DAMAGES DISCLAIMER**, which is part of Central's Standard Terms and Conditions of sale, visit: www.centrasemi.com/terms