

Dual, 8-Bit, Voltage-Output Serial DAC in 8-Pin SO Package

ABSOLUTE MAXIMUM RATINGS

V_{DD} to GND	-0.3V, +6V
Digital Inputs and Outputs to GND	-0.3V, ($V_{DD} + 0.3V$)
REF	-0.3V, ($V_{DD} + 0.3V$)
OUTA, OUTB (Note 1)	V_{DD}
Continuous Power Dissipation ($T_A = +70^\circ\text{C}$)	
Plastic DIP (derate 9.09mW/ $^\circ\text{C}$ above $+70^\circ\text{C}$)	727mW
SO (derate 5.88mW/ $^\circ\text{C}$ above $+70^\circ\text{C}$)	471mW

Operating Temperature Ranges

MAX522C_A	0°C to $+70^\circ\text{C}$
MAX522E_A	-40°C to $+85^\circ\text{C}$
Storage Temperature Range	-65°C to $+165^\circ\text{C}$
Lead Temperature (soldering, 10sec)	$+300^\circ\text{C}$

Note 1: The outputs may be shorted to V_{DD} or GND if the package power dissipation is not exceeded. Typical short-circuit current to GND is 50mA.

Stresses beyond those listed under "Absolute Maximum Ratings" may cause permanent damage to the device. These are stress ratings only, and functional operation of the device at these or any other conditions beyond those indicated in the operational sections of the specifications is not implied. Exposure to absolute maximum rating conditions for extended periods may affect device reliability.

ELECTRICAL CHARACTERISTICS

($V_{DD} = +2.7V$ to $+5.5V$, REF = V_{DD} , $T_A = T_{MIN}$ to T_{MAX} , unless otherwise noted. Typical values are at $T_A = +25^\circ\text{C}$.)

PARAMETER	SYMBOL	CONDITIONS	MIN	TYP	MAX	UNITS
STATIC PERFORMANCE						
Resolution	N		8			Bits
Differential Nonlinearity	DNL	Guaranteed monotonic			± 1	LSB
Integral Nonlinearity	INL	(Note 2)			± 1.5	LSB
Total Unadjusted Error	TUE	(Note 2)		± 1		LSB
Zero-Code Temperature Coefficient				100		$\mu\text{V}/^\circ\text{C}$
Power-Supply Rejection Ratio	PSRR	$4.5V \leq V_{DD} \leq 5.5V$, REF = 4.096V		0.01		%/%
		$2.7V \leq V_{DD} \leq 3.6V$, REF = 2.4V		0.015		
REFERENCE INPUTS						
Reference Input Voltage Range			GND		V_{DD}	V
Reference Input Capacitance				25		pF
Reference Input Resistance	R_{REF}	(Note 3)	8			$k\Omega$
Reference Input Resistance (shutdown mode)				2		$M\Omega$
DAC OUTPUTS						
Output Voltage Range			0		REF	V
Capacitive Load at OUT_		DAC A	0.1			μF
		DAC B	0.01			
Output Resistance		DAC A		50		Ω
		DAC B		500		
DIGITAL INPUTS						
Input High Voltage	V_{IH}		(0.7)(V_{DD})			V
Input Low Voltage	V_{IL}			(0.3)(V_{DD})		V
Input Current	I_{IN}	$V_{IN} = 0V$ or V_{DD}		0.1	± 10	μA
Input Capacitance	C_{IN}	(Notes 4, 5)			10	pF

Dual, 8-Bit, Voltage-Output Serial DAC in 8-Pin SO Package

MAX522

ELECTRICAL CHARACTERISTICS (continued)

($V_{DD} = +2.7V$ to $+5.5V$, $REF = V_{DD}$, $T_A = T_{MIN}$ to T_{MAX} , unless otherwise noted. Typical values are at $T_A = +25^\circ C$.)

PARAMETER	SYMBOL	CONDITIONS	MIN	TYP	MAX	UNITS
DYNAMIC PERFORMANCE						
Voltage-Output Slew Rate	SR	$C_L = 0.1\mu F$ (DAC A), $C_L = 0.01\mu F$ (DAC B)		0.1		V/ μs
Voltage-Output Settling Time		$T_o \pm 1/2LSB$	$C_L = 0.1\mu F$ (DAC A)	70		μs
			$C_L = 0.01\mu F$ (DAC B)	70		
Digital Feedthrough and Crosstalk		All 0s to all 1s		10		nV-s
POWER SUPPLIES						
Supply Voltage Range	V_{DD}		2.7		5.5	V
Supply Current	I_{DD}	All inputs = 0V	$V_{DD} = 5.5V$	1.3	2.8	mA
			$V_{DD} = 3.6V$	0.9	2.5	
Shutdown Supply Current		$V_{DD} = 5.5V$		0.1		μA

TIMING CHARACTERISTICS (Note 4)

($V_{DD} = +2.7V$ to $+5.5V$, $T_A = T_{MIN}$ to T_{MAX} , unless otherwise noted.)

PARAMETER	SYMBOL	CONDITIONS	MIN	TYP	MAX	UNITS
SERIAL INTERFACE TIMING						
\overline{CS} Fall to SCLK Rise Setup Time	t_{CSS}		150			ns
SCLK Rise to \overline{CS} Rise Setup Time	t_{CSH}		150			ns
DIN to SCLK Rise Setup Time	t_{DS}		50			ns
DIN to SCLK Rise Hold Time	t_{DH}		50			ns
SCLK Pulse Width High	t_{CH}		100			ns
SCLK Pulse Width Low	t_{CL}		100			ns
\overline{CS} Pulse Width High	t_{CSPWH}		200			ns

Note 2: Reduced digital code range (code 24 through code 232) is due to swing limitations of the output amplifiers. See *Typical Operating Characteristics*.

Note 3: Reference input resistance is code dependent. The lowest input resistance occurs at code 55hex. Refer to the *Reference Input* section in the *Detailed Description*.

Note 4: Guaranteed by design. Not production tested.

Note 5: Input capacitance is code dependent. The highest capacitance occurs at code 00hex.

Dual, 8-Bit, Voltage-Output Serial DAC in 8-Pin SO Package

Typical Operating Characteristics

($T_A = +25^\circ\text{C}$, unless otherwise noted.)

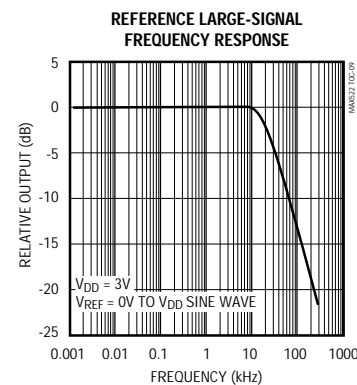
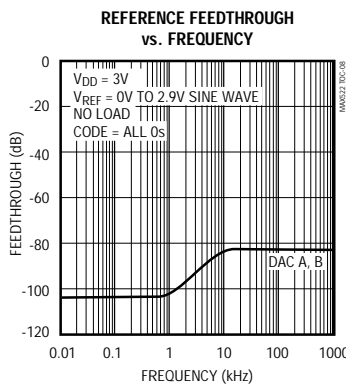
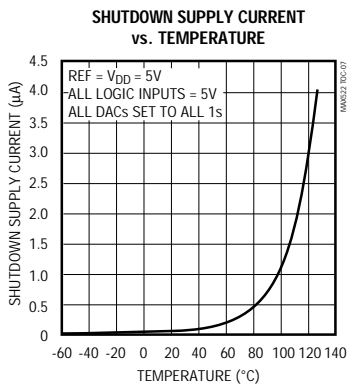
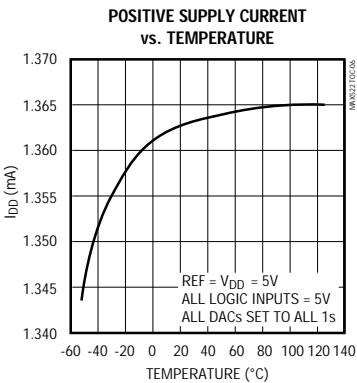
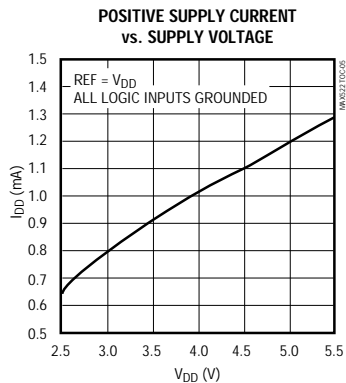
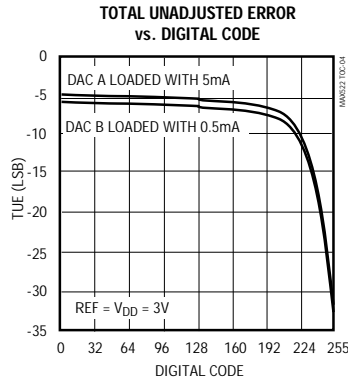
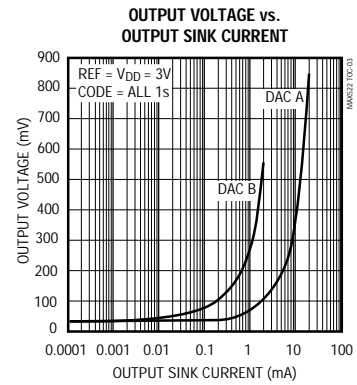
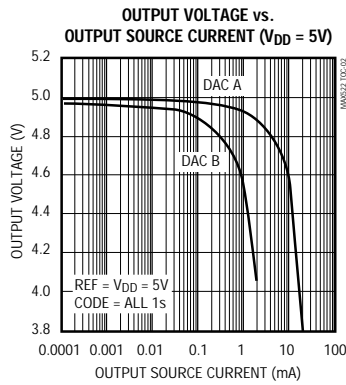
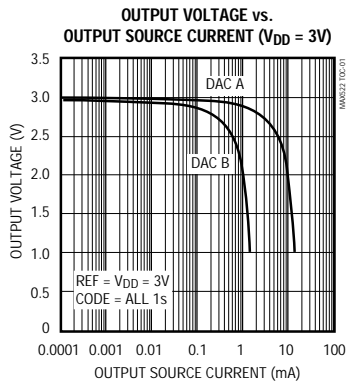

Dual, 8-Bit, Voltage-Output Serial DAC in 8-Pin SO Package

MAX522

Typical Operating Characteristics (continued)
($T_A = +25^\circ\text{C}$, unless otherwise noted.)

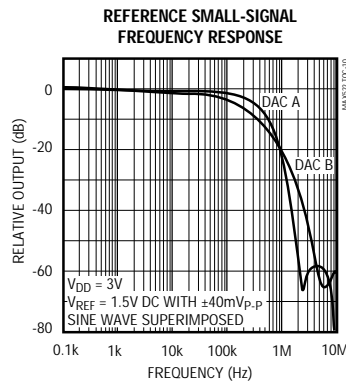

LINE-TRANSIENT RESPONSE (OUTA)

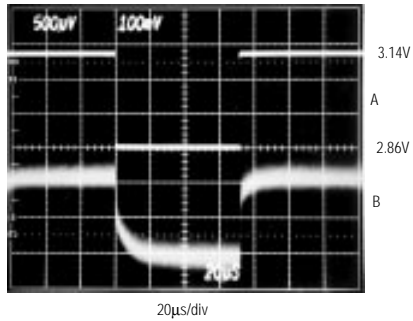

REF = 2.56V, NO LOAD, CODE = ALL 1s
A : V_{DD} , 100mV/div
B : OUTA, 500µV/div

CLOCK FEEDTHROUGH (OUTA)

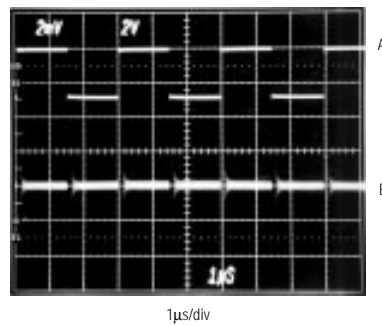

$\overline{CS} = \text{HIGH}$
A : SCLK, 333kHz, 0V TO 2.9V, 2V/div
B : OUTA, 2mV/div

Dual, 8-Bit, Voltage-Output Serial DAC in 8-Pin SO Package

Typical Operating Characteristics (continued)
(T_A = +25°C, unless otherwise noted).

POSITIVE SETTLING TIME (DAC A)

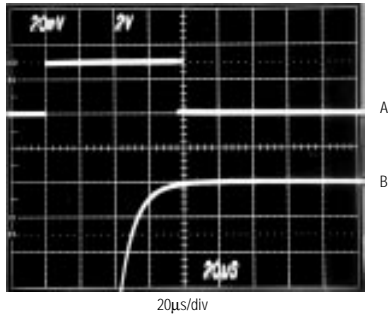

V_{DD} = 3V, REF = V_{DD}, R_L = 1k Ω, C_L = 0.1µF,
ALL BITS OFF TO ALL BITS ON
A: CS, 2V/div
B: OUTA, 20mV/div

POSITIVE SETTLING TIME (DAC B)

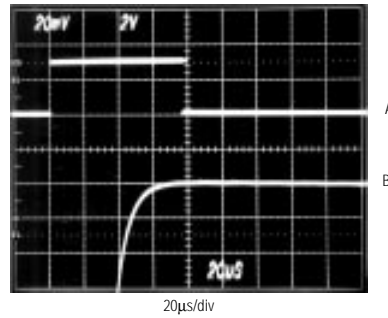

V_{DD} = 3V, REF = V_{DD}, R_L = 10k Ω, C_L = 0.01µF,
ALL BITS OFF TO ALL BITS ON
A: CS, 2V/div
B: OUTB, 20mV/div

TIME EXITING SHUTDOWN MODE

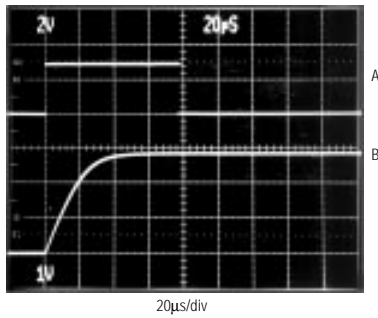

V_{DD} = 3V, REF = V_{DD}, R_L = 1k Ω, C_L = 0.1µF,
DAC LOADED WITH ALL 1s
A: CS, 2V/div
B: OUTA, 1V/div

OUTPUT VOLTAGE NOISE (DC TO 1MHz)

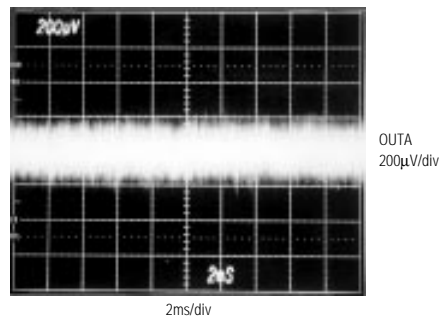

DIGITAL CODE = 80, REF = V_{DD}, NO LOAD

Dual, 8-Bit, Voltage-Output Serial DAC in 8-Pin SO Package

Pin Description

MAX522

PIN	NAME	FUNCTION
1	\overline{CS}	Chip Select (active low). Enables data to be shifted into the 16-bit shift register. Programming commands are executed at the rising edge of \overline{CS} .
2	SCLK	Serial Clock Input. Data is clocked in on the rising edge of SCLK.
3	V _{DD}	Positive Power Supply (2.7V to 5.5V). Bypass with 0.22 μ F to GND.
4	GND	Ground
5	OUTA	DAC A Output Voltage (Buffered). Connect 0.1μF capacitor or greater to GND.
6	OUTB	DAC B Output Voltage (Buffered). Connect 0.01μF capacitor or greater to GND.
7	REF	Reference Input for DAC A and DAC B
8	DIN	Serial Data Input of the 16-bit shift register. Data is clocked into the register on the rising edge of SCLK.

Detailed Description

Analog Section

The MAX522 contains two 8-bit, voltage-output digital-to-analog converters (DACs). The DACs are “inverted” R-2R ladder networks using complementary switches that convert 8-bit digital inputs into equivalent analog output voltages in proportion to the applied reference voltage.

The MAX522 has one reference input which is shared by DAC A and DAC B. The device includes output buffer amplifiers for both DACs and input logic for simple microprocessor (μ P) and CMOS interfaces. The power-supply range is from +5.5V down to +2.7V.

Reference Input and DAC Output Range

The voltage at REF sets the full-scale output of the DACs. The input impedance of the REF input is code dependent. The lowest value, approximately 8k Ω , occurs when the input code is 01010101 (55hex). The maximum value of infinity occurs when the input code is zero.

In shutdown mode, the selected DAC output is set to zero while the value stored in the DAC register remains unchanged. This removes the load from the reference input to save power. Bringing the MAX522 out of shutdown mode restores the DAC output voltage. Because the input resistance at REF is code dependent, the DAC’s reference sources should have an output impedance of no more than 5 Ω . The input capacitance at the REF pin is also code dependent and typically does not exceed 25pF.

The reference voltage on REF can range anywhere from GND to V_{DD}. See the *Output Buffer Amplifier* section for more information.

Output Buffer Amplifiers

DAC A and DAC B voltage outputs are internally buffered. The buffer amplifiers have a rail-to-rail (GND to V_{DD}) output voltage range.

The DAC outputs are internally divided by two and the buffer is set to a gain of two, eliminating the need for a buffer input voltage range to the positive supply rail.

DAC A’s output amplifier can source and sink up to 5mA of current (0.5mA for DAC B’s buffer). See the Total Unadjusted Error vs. Digital Code graph in the *Typical Operating Characteristics*. The amplifier is unity-gain stable with a capacitive load of 0.1 μ F (0.01 μ F for DAC B’s buffer) or greater. The slew rate is limited by the load capacitor and is typically 0.1V/ μ s with a 0.1 μ F load (0.01 μ F for DAC B’s buffer).

Shutdown Mode

When programmed to shutdown mode, the outputs of DAC A and DAC B go into a high-impedance state. Virtually no current flows into or out of the buffer amplifiers in that state. In shutdown mode, the REF inputs are high impedance (2M Ω typical) to conserve current drain from the system reference; therefore, the system reference does not have to be powered down.

Coming out of shutdown, the DAC outputs return to the values kept in the registers. The recovery time is equivalent to the DAC settling time.

Dual, 8-Bit, Voltage-Output Serial DAC in 8-Pin SO Package

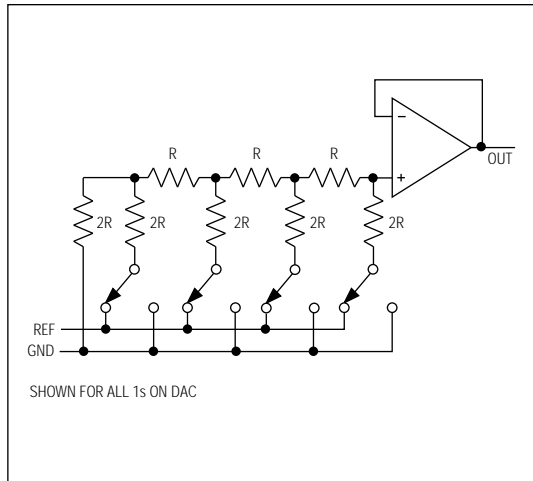

Figure 1. DAC Simplified Circuit Diagram

Serial Interface

An active-low chip select (\overline{CS}) enables the shift register to receive data from the serial data input. Data is clocked into the shift register on every rising edge of the serial clock signal (SCLK). The clock frequency can be as high as 5MHz.

Data is sent MSB first and can be transmitted in one 16-bit word. The write cycle can be segmented when \overline{CS} is kept active (low) to allow, for example, two 8-bit-wide transfers. After clocking all 16 bits into the input shift register, the rising edge of \overline{CS} updates the DAC outputs and the shutdown status. Because of their single buffered structure, DACs cannot be simultaneously updated to different digital values.

Table 1. Input Shift Register

DATA BITS	B0*	DAC Data Bit 0 (LSB)
	B1	DAC Data Bit 1
	B2	DAC Data Bit 2
	B3	DAC Data Bit 3
	B4	DAC Data Bit 4
	B5	DAC Data Bit 5
	B6	DAC Data Bit 6
	B7	DAC Data Bit 7 (MSB)
CONTROL BITS	LA	Load Reg DAC A, Active High
	LB	Load Reg DAC B, Active High
	UB4	Uncommitted Bit 4
	SA	Shut Down DAC A, Active High
	SB	Shut Down DAC B, Active High
	UB3	Uncommitted Bit 3
	UB2	Uncommitted Bit 2
	UB1**	Uncommitted Bit 1

* Clocked in last.

**Clocked in first.

Serial-Input Data Format and Control Codes

Table 2 lists the serial-input data format. The 16-bit input word consists of an 8-bit control byte and an 8-bit data byte. The 8-bit control byte is not decoded internally. Every control bit performs one function. Data is clocked in starting with UB1 (Uncommitted Bit), followed by the remaining control bits and the data byte. The LSB of the data byte (B0) is the last bit clocked into the shift register (Figure 2).

Table 3 is an example of a 16-bit input word. It performs the following functions:

- 80hex (128 decimal) loaded into DAC registers A and B.
- DAC A and DAC B are active.

Dual, 8-Bit, Voltage-Output Serial DAC in 8-Pin SO Package

MAX522

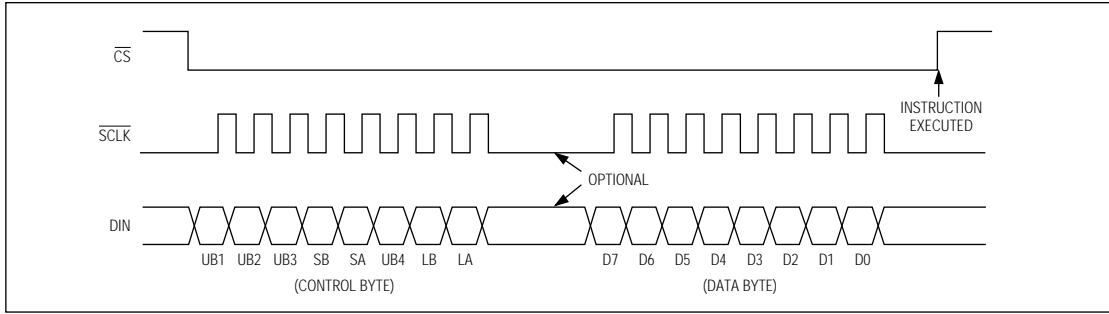

Figure 2. MAX522 3-Wire Serial-Interface Timing Diagram

Table 2. Serial-Interface Programming Commands

CONTROL									DATA								FUNCTION
UB1	UB2	UB3	SB	SA	UB4	LB	LA	B7 MSB	B6	B5	B4	B3	B2	B1	B0 LSB		
X	X	1	*	*	0	0	0	X	X	X	X	X	X	X	X	No Operation to DAC Registers	
X	X	1	*	*	0	0	0									Unassigned Command	
X	X	1	*	*	0	1	0	8-Bit DAC Data								Load Register to DAC B	
X	X	1	*	*	0	0	1	8-Bit DAC Data								Load Register to DAC A	
X	X	1	*	*	0	1	1	8-Bit DAC Data								Load Both DAC Registers	
X	X	1	0	0	0	*	*	X	X	X	X	X	X	X	X	All DACs Active	
X	X	1	0	0	0	*	*	X	X	X	X	X	X	X	X	Unassigned Command	
X	X	1	1	0	0	*	*	X	X	X	X	X	X	X	X	Shut Down DAC B	
X	X	1	0	1	0	*	*	X	X	X	X	X	X	X	X	Shut Down DAC A	
X	X	1	1	1	0	*	*	X	X	X	X	X	X	X	X	Shut Down All DACs	

X = Don't care.

* = Not shown, for the sake of clarity. The functions of loading and shutting down the DACs and programming the logic can be combined in a single command.

Table 3. Example of a 16-Bit Input Word

Loaded in First																Loaded in Last
UB1	UB2	UB3	SB	SA	UB4	LB	LA	B7	B6	B5	B4	B3	B2	B1	B0	
X	X	1	0	0	0	1	1	1	0	0	0	0	0	0	0	

Dual, 8-Bit, Voltage-Output Serial DAC in 8-Pin SO Package

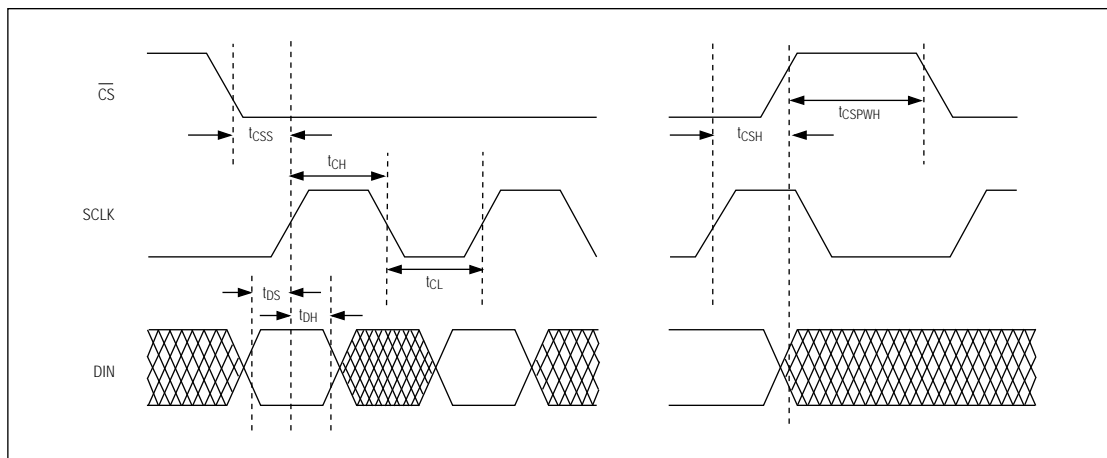

Figure 3. MAX522 Detailed Serial-Interface Timing Diagram

Digital Inputs

The digital inputs are compatible with CMOS logic. Supply current increases slightly when toggling the logic inputs through the transition zone between $(0.3)(V_{DD})$ and $(0.7)(V_{DD})$.

Microprocessor Interfacing

The MAX522 serial interface is compatible with Microwire, SPI, and QSPI. For SPI, clear the CPOL and CPHA bits (CPOL = 0 and CPHA = 0). CPOL = 0 sets the inactive clock state to zero and CPHA = 0 changes data at the falling edge of SCLK. This setting allows SPI to run at full clock speeds (0.5MHz). If a serial port is not available on your μP , three bits of a parallel port can be used to emulate a serial port by bit manipulation. Minimize digital feedthrough at the voltage outputs by operating the serial clock only when necessary.

Table 4. Code Table

DAC CONTENTS								ANALOG OUTPUT
B7	B6	B5	B4	B3	B2	B1	B0	
1	1	1	1	1	1	1	1	$+REF \times \left(\frac{255}{256}\right)$
1	0	0	0	0	0	0	1	$+REF \times \left(\frac{129}{256}\right)$
1	0	0	0	0	0	0	0	$+REF \times \left(\frac{128}{256}\right) = +\frac{REF}{2}$
0	1	1	1	1	1	1	1	$+REF \times \left(\frac{127}{256}\right)$
0	0	0	0	0	0	0	1	$+REF \times \left(\frac{1}{256}\right)$
0	0	0	0	0	0	0	0	0V

Note:

$$1\text{LSB} = REF \times 2^{-8} = REF \times \left(\frac{1}{256}\right)$$

$$\text{ANALOG OUTPUT} = REF \times \left(\frac{D}{256}\right) \text{ where } D = \text{Decimal Value of Digital Input}$$

Dual, 8-Bit, Voltage-Output Serial DAC in 8-Pin SO Package

MAX522

Applications Information

The MAX522 is specified for single-supply operation with V_{DD} ranging from 2.7V to 5.5V, covering all commonly used supply voltages in 3V and 5V systems.

Initialization

There is no internal power-on reset. Therefore, at power-up, perform an initial write operation to set the outputs to the desired voltage.

Power-Supply and Ground Management

GND should be connected to the highest quality ground available. Bypass V_{DD} with a 0.1 μ F to 0.22 μ F capacitor to GND. The reference input can be used without bypassing. For optimum line/load-transient response and noise performance, bypass the reference input with 0.1 μ F to 4.7 μ F to GND. Careful PC board layout minimizes crosstalk among DAC outputs, the reference, and digital inputs. Separate analog lines with ground traces between them. Make sure that high-frequency digital lines are not routed in parallel to analog lines.

MAX522

Dual, 8-Bit, Voltage-Output Serial DAC in 8-Pin SO Package

Package Information

**Plastic DIP
PLASTIC
DUAL-IN-LINE
PACKAGE
(0.300 in.)**

DIM	INCHES		MILLIMETERS	
	MIN	MAX	MIN	MAX
A	—	0.200	—	5.08
A1	0.015	—	0.38	—
A2	0.125	0.175	3.18	4.45
A3	0.055	0.080	1.40	2.03
B	0.016	0.022	0.41	0.56
B1	0.045	0.065	1.14	1.65
C	0.008	0.012	0.20	0.30
D1	0.005	0.080	0.13	2.03
E	0.300	0.325	7.62	8.26
E1	0.240	0.310	6.10	7.87
e	0.100	—	2.54	—
eA	0.300	—	7.62	—
eB	—	0.400	—	10.16
L	0.115	0.150	2.92	3.81

PKG.	DIM	PINS	INCHES		MILLIMETERS	
			MIN	MAX	MIN	MAX
P	D	8	0.348	0.390	8.84	9.91
P	D	14	0.735	0.765	18.67	19.43
P	D	16	0.745	0.765	18.92	19.43
P	D	18	0.885	0.915	22.48	23.24
P	D	20	1.015	1.045	25.78	26.54
N	D	24	1.14	1.265	28.96	32.13

21-0043A

**Narrow SO
SMALL-OUTLINE
PACKAGE
(0.150 in.)**

DIM	INCHES		MILLIMETERS	
	MIN	MAX	MIN	MAX
A	0.053	0.069	1.35	1.75
A1	0.004	0.010	0.10	0.25
B	0.014	0.019	0.35	0.49
C	0.007	0.010	0.19	0.25
E	0.150	0.157	3.80	4.00
e	0.050		1.27	
H	0.228	0.244	5.80	6.20
L	0.016	0.050	0.40	1.27

DIM	PINS	INCHES		MILLIMETERS	
		MIN	MAX	MIN	MAX
D	8	0.189	0.197	4.80	5.00
D	14	0.337	0.344	8.55	8.75
D	16	0.386	0.394	9.80	10.00

21-0041A

Maxim cannot assume responsibility for use of any circuitry other than circuitry entirely embodied in a Maxim product. No circuit patent licenses are implied. Maxim reserves the right to change the circuitry and specifications without notice at any time.

12 _____ Maxim Integrated Products, 120 San Gabriel Drive, Sunnyvale, CA 94086 (408) 737-7600

© 1995 Maxim Integrated Products

Printed USA

MAXIM is a registered trademark of Maxim Integrated Products.

Mouser Electronics

Authorized Distributor

Click to View Pricing, Inventory, Delivery & Lifecycle Information:

[Maxim Integrated:](#)

[MAX522CPA+](#) [MAX522CSA+](#) [MAX522ESA+](#) [MAX522CSA+T](#) [MAX522EPA+](#) [MAX522ESA+T](#)