

# MAX4173

## Low-Cost, SOT23, Voltage-Output, High-Side Current-Sense Amplifier

### ABSOLUTE MAXIMUM RATINGS

V<sub>CC</sub>, RS+, RS- to GND ..... -0.3V to +30V  
 OUT to GND ..... -0.3V to (V<sub>CC</sub> + 0.3V)  
 Output Short-Circuit to V<sub>CC</sub> or GND ..... Continuous  
 Differential Input Voltage (V<sub>RS+</sub> - V<sub>RS-</sub>) ..... ±0.3V  
 Current into Any Pin ..... ±20mA

Continuous Power Dissipation (T<sub>A</sub> = +70°C)  
 8-Pin SO (derate 5.88mW/°C above +70°C) ..... 471mW  
 SOT23-6 (derate 8.7mW/°C above +70°C) ..... 696mW  
 Operating Temperature Range ..... -40°C to +85°C  
 Storage Temperature Range ..... -65°C to +150°C  
 Lead Temperature (soldering, 10s) ..... +300°C  
 Soldering Temperature (reflow) ..... +260°C

Stresses beyond those listed under "Absolute Maximum Ratings" may cause permanent damage to the device. These are stress ratings only, and functional operation of the device at these or any other conditions beyond those indicated in the operational sections of the specifications is not implied. Exposure to absolute maximum rating conditions for extended periods may affect device reliability.

### ELECTRICAL CHARACTERISTICS

(V<sub>RS+</sub> = 0 to +28V, V<sub>CC</sub> = +3V to +28V, V<sub>SENSE</sub> = 0V, T<sub>A</sub> = T<sub>MIN</sub> to T<sub>MAX</sub>, R<sub>LOAD</sub> = ∞ unless otherwise noted. Typical values are at T<sub>A</sub> = +25°C.) (Note 1)

PARAMETER	SYMBOL	CONDITIONS	MIN	TYP	MAX	UNITS
Operating Voltage Range	V <sub>CC</sub>	Guaranteed by PSR test	3		28	V
Common-Mode Input Range	V <sub>CMR</sub>	(Note 2)	0		28	V
Common-Mode Rejection	CMR	V <sub>RS+</sub> > +2.0V		90		dB
Supply Current	I <sub>CC</sub>	V <sub>RS+</sub> > +2.0V, V <sub>CC</sub> > 12V		0.42	1.0	mA
Leakage Current	I <sub>RS+</sub> , I <sub>RS-</sub>	V <sub>CC</sub> = 0V, V <sub>RS+</sub> = 28V		0.3	3	µA
Input Bias Current	I <sub>RS+</sub>	V <sub>RS+</sub> > +2.0V	0		50	µA
		V <sub>RS+</sub> ≤ +2.0V	-350		50	
	I <sub>RS-</sub>	V <sub>RS+</sub> > +2.0V	0		100	
		V <sub>RS+</sub> ≤ +2.0V	-700		100	
Full-Scale Sense Voltage	V <sub>SENSE</sub>	V <sub>SENSE</sub> = V <sub>RS+</sub> - V <sub>RS-</sub>		150		mV
Total OUT Voltage Error (Note 3)		V <sub>SENSE</sub> = +100mV, V <sub>CC</sub> = +12V, V <sub>RS+</sub> = +12V		±0.5	5.75	%
		V <sub>SENSE</sub> = +100mV, V <sub>CC</sub> = +12V, V <sub>RS+</sub> = +12V, T <sub>A</sub> = +25°C		0.5	3.25	
		V <sub>SENSE</sub> = +100mV, V <sub>CC</sub> = +28V, V <sub>RS+</sub> = +28V		0.5	5.75	
		V <sub>SENSE</sub> = +100mV, V <sub>CC</sub> = +12V, V <sub>RS+</sub> = +0.1V		-9	±24	
		V <sub>CC</sub> = +12V, V <sub>RS+</sub> = +12V, V <sub>SENSE</sub> = +6.25mV (Note 4)		±7.5		
Out High Voltage (Note 5)	(V <sub>CC</sub> - V <sub>OH</sub> )	MAX4173T, V <sub>CC</sub> = +3.0V, V <sub>RS+</sub> = 28V, V <sub>SENSE</sub> = 250mV		0.8	1.2	V
		MAX4173F, V <sub>CC</sub> = +7.5V, V <sub>RS+</sub> = 28V, V <sub>SENSE</sub> = 250mV		0.8	1.2	
		MAX4173H, V <sub>CC</sub> = +15V, V <sub>RS+</sub> = 28V, V <sub>SENSE</sub> = 250mV		0.8	1.2	
OUT Low Voltage	V <sub>OL</sub>	MAX4173TEUT, V <sub>CC</sub> = +5V, V <sub>RS+</sub> = 0.89V, V <sub>SENSE</sub> = 0mV	T <sub>A</sub> = +25°C	1.2	5	mV
			T <sub>A</sub> = -40°C to +85°C			

# MAX4173

## Low-Cost, SOT23, Voltage-Output, High-Side Current-Sense Amplifier

### ELECTRICAL CHARACTERISTICS (continued)

( $V_{RS+} = 0$  to  $+28V$ ,  $V_{CC} = +3V$  to  $+28V$ ,  $V_{SENSE} = 0V$ ,  $T_A = T_{MIN}$  to  $T_{MAX}$ ,  $R_{LOAD} = \infty$  unless otherwise noted. Typical values are at  $T_A = +25^\circ C$ .) (Note 1)

PARAMETER	SYMBOL	CONDITIONS		MIN	TYP	MAX	UNITS
Bandwidth	BW	$V_{RS+} = +12V$ , $V_{CC} = +12V$ , $C_{LOAD} = 5pF$	MAX4173T, $V_{SENSE} = +100mV$		1.7		MHz
			MAX4173F, $V_{SENSE} = +100mV$		1.4		
			MAX4173H, $V_{SENSE} = +100mV$		1.2		
			$V_{SENSE} = +6.25mV$ (Note 4)		0.6		
Gain	$A_V$	MAX4173T			20		V/V
		MAX4173F			50		
		MAX4173H			100		
Gain Accuracy	$\Delta A_V$	MAX4173T/F $V_{SENSE} = +10mV$ to $+150mV$ , $V_{CC} = V_{RS+} = 12V$	$T_A = +25^\circ C$		0.5	$\pm 2.5$	%
			$T_A = -40^\circ C$ to $+85^\circ C$			4.0	
	$\Delta A_V$	MAX4173H $V_{SENSE} = +10mV$ to $+100mV$ , $V_{CC} = V_{RS+} = 12V$	$T_A = +25^\circ C$		0.5	$\pm 2.5$	
			$T_A = -40^\circ C$ to $+85^\circ C$			4.0	
Input Offset Voltage (Note 6)	$V_{OS}$	MAX4173TEUT, $V_{RS+} = 12V$	$T_A = +25^\circ C$		0.3	$\pm 3$	mV
			$T_A = -40^\circ C$ to $+85^\circ C$				
OUT Settling Time to 1% of Final Value		$V_{CC} = +12V$ , $V_{RS+} = 12V$ , $C_{LOAD} = 5pF$	$V_{SENSE} = +6.25mV$ to $+100mV$		400		ns
			$V_{SENSE} = +100mV$ to $+6.25mV$		800		
OUT Output Resistance	$R_{OUT}$				12		k $\Omega$
Power-Supply Rejection	PSR	MAX4173T, $V_{SENSE} = 80mV$ , $V_{RS+} \geq +2V$		60	84		dB
		MAX4173F, $V_{SENSE} = 32mV$ , $V_{RS+} \geq +2V$		60	91		
		MAX4173H, $V_{SENSE} = 16mV$ , $V_{RS+} \geq +2V$		60	95		
Power-Up Time to 1% of Final Value		$V_{SENSE} = +100mV$ , $C_{LOAD} = 5pF$			10		$\mu s$
Saturation Recovery Time		$V_{CC} = +12V$ , $V_{RS+} = 12V$ (Note 7)			10		$\mu s$

**Note 1:** All devices are 100% production tested at  $T_A = +25^\circ C$ . All temperature limits are guaranteed by design.

**Note 2:** Guaranteed by Total Output Voltage Error Test.

**Note 3:** Total OUT Voltage Error is the sum of gain and offset voltage errors.

**Note 4:**  $+6.25mV = 1/16$  of  $+100mV$  full-scale voltage.

**Note 5:**  $V_{SENSE}$  such that output stage is in saturation.

**Note 6:**  $V_{OS}$  is extrapolated from the Gain Accuracy tests.

**Note 7:** The device does not experience phase reversal when overdriven.

# MAX4173

## Low-Cost, SOT23, Voltage-Output, High-Side Current-Sense Amplifier

### Typical Operating Characteristics

( $V_{CC} = +12V$ ,  $V_{RS+} = +12V$ ,  $V_{SENSE} = +100mV$ ,  $T_A = +25^\circ C$ , unless otherwise noted.)

**SUPPLY CURRENT vs. SUPPLY VOLTAGE**

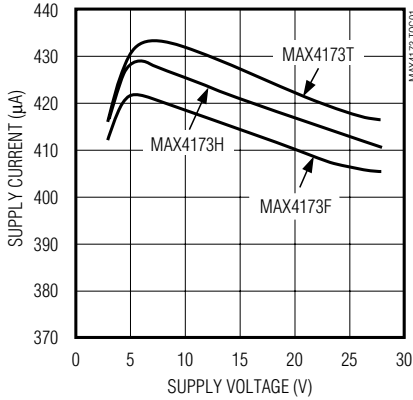

**SUPPLY CURRENT vs. TEMPERATURE**

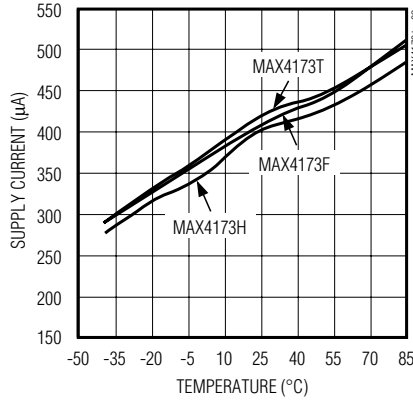

**SUPPLY CURRENT vs. RS+ VOLTAGE**

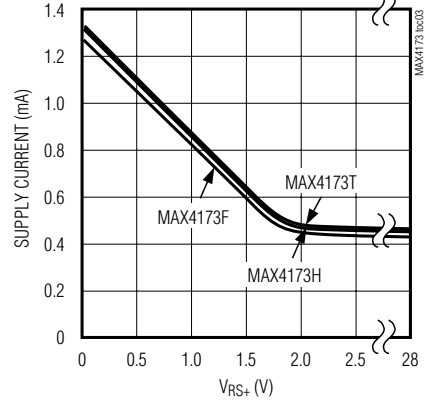

**TOTAL OUTPUT ERROR vs. SUPPLY VOLTAGE**

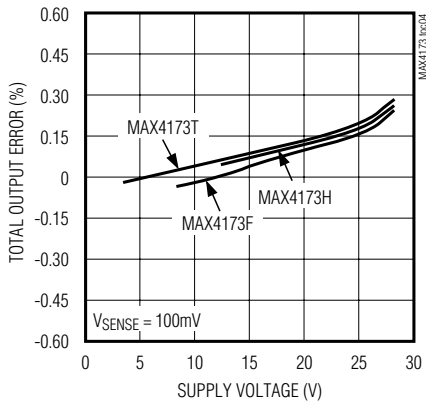

**TOTAL OUTPUT ERROR vs. SUPPLY VOLTAGE**

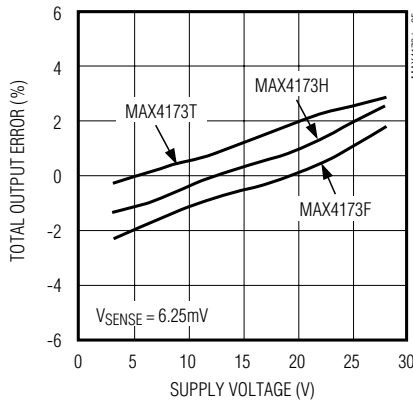

**TOTAL OUTPUT ERROR vs. FULL-SCALE SENSE VOLTAGE**

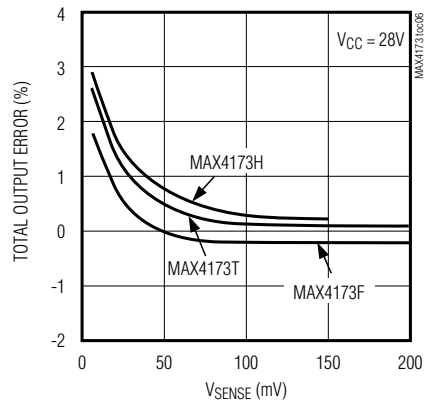

**POWER-SUPPLY REJECTION vs. FREQUENCY**

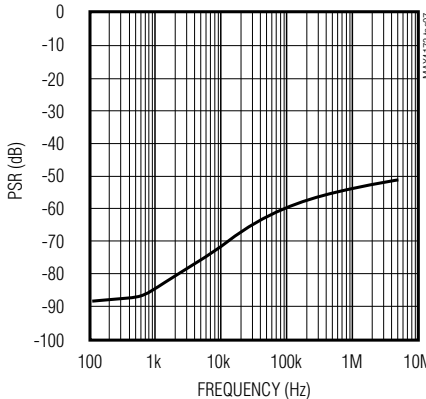

**TOTAL OUTPUT ERROR vs. COMMON-MODE VOLTAGE**

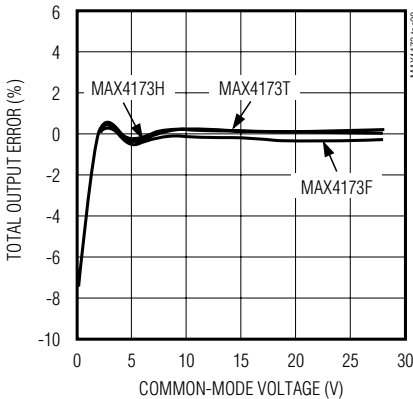

**GAIN ACCURACY vs. TEMPERATURE**

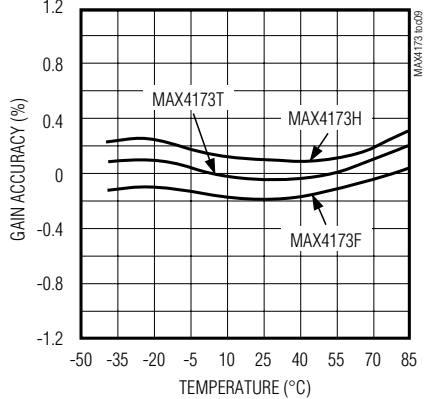

# MAX4173

## Low-Cost, SOT23, Voltage-Output, High-Side Current-Sense Amplifier

### Typical Operating Characteristics (continued)

( $V_{CC} = +12V$ ,  $V_{RS+} = +12V$ ,  $V_{SENSE} = +100mV$ ,  $T_A = +25^{\circ}C$ , unless otherwise noted.)

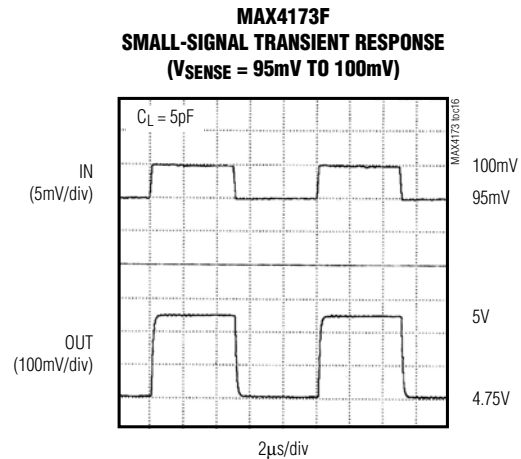
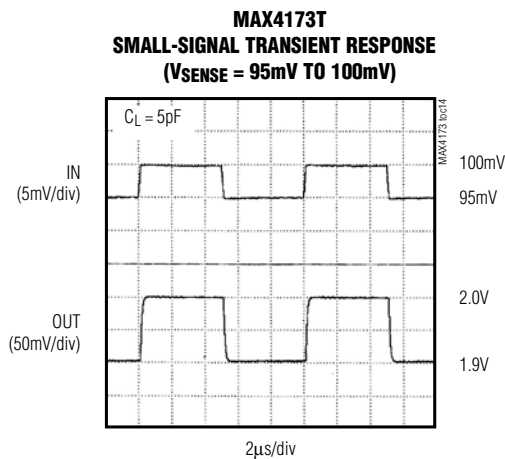
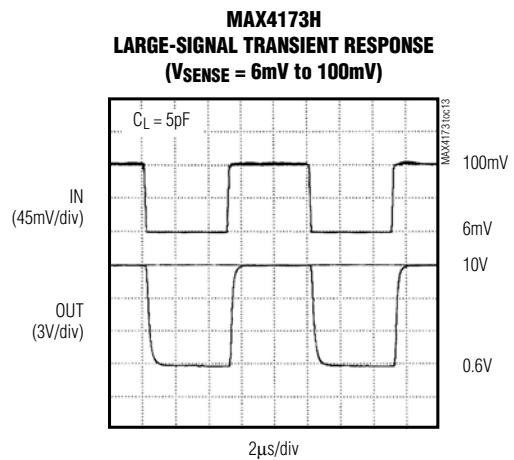
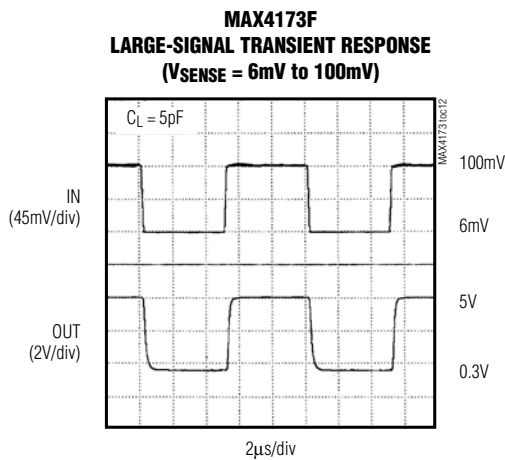
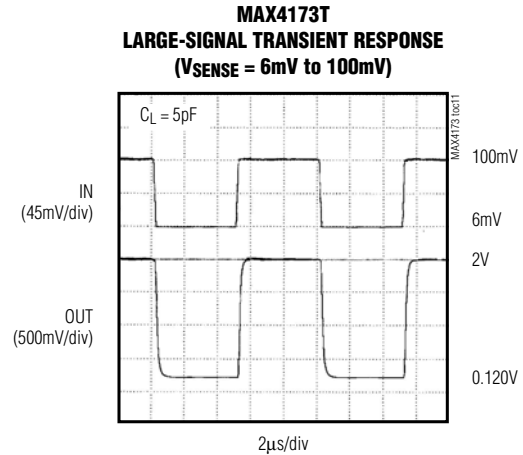
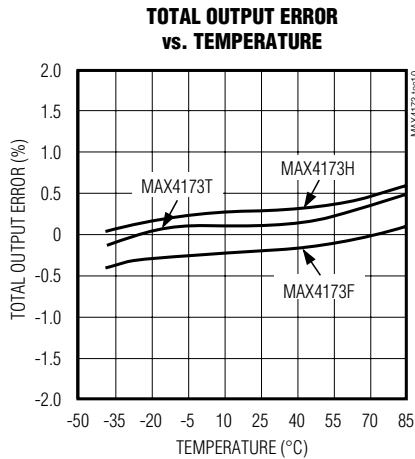

# MAX4173

## Low-Cost, SOT23, Voltage-Output, High-Side Current-Sense Amplifier

### Typical Operating Characteristics (continued)

( $V_{CC} = +12V$ ,  $V_{RS+} = +12V$ ,  $V_{SENSE} = +100mV$ ,  $T_A = +25^\circ C$ , unless otherwise noted.)

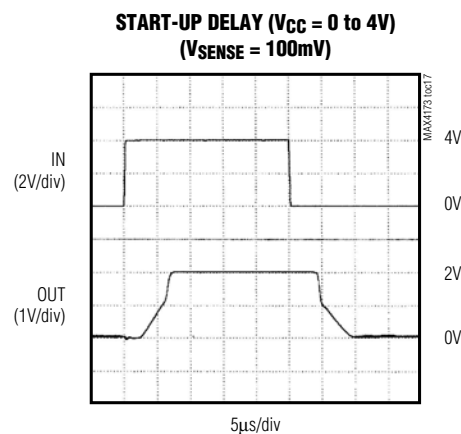
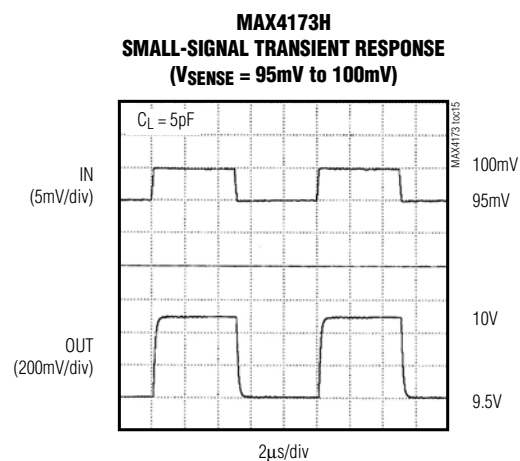

### Pin Description

PIN		NAME	FUNCTION
SOT23	SO		
1, 2	3	GND	Ground
3	1	V <sub>CC</sub>	Supply Voltage Input. Bypass to GND with a 0.1µF capacitor.
4	8	RS+	Power-Side Connection to the External Sense Resistor
5	6	RS-	Load-Side Connection for the External Sense Resistor
6	4	OUT	Voltage Output. V <sub>OUT</sub> is proportional to V <sub>SENSE</sub> ( V <sub>RS+</sub> - V <sub>RS-</sub> ). Output impedance is approximately 12kΩ.
-	2, 5, 7	N.C.	No Connection. Not internally connected.

# MAX4173

## Low-Cost, SOT23, Voltage-Output, High-Side Current-Sense Amplifier

### Detailed Description

The MAX4173 high-side current-sense amplifier features a 0 to +28V input common-mode range that is independent of supply voltage. This feature allows the monitoring of current out of a battery in deep discharge and also enables high-side current sensing at voltages greater than the supply voltage ( $V_{CC}$ ).

The MAX4173 operates as follows: Current from the source flows through  $R_{SENSE}$  to the load (Figure 1). Since the internal-sense amplifier's inverting input has high impedance, negligible current flows through  $R_{G2}$  (neglecting the input bias current). Therefore, the sense amplifier's inverting-input voltage equals  $V_{SOURCE} - (I_{LOAD})(R_{SENSE})$ . The amplifier's open-loop gain forces its noninverting input to the same voltage as the inverting input. Therefore, the drop across  $R_{G1}$  equals  $(I_{LOAD})(R_{SENSE})$ . Since  $I_{RG1}$  flows through  $R_{G1}$ ,  $I_{RG1} = (I_{LOAD})(R_{SENSE}) / R_{G1}$ . The internal current mirror multiplies  $I_{RG1}$  by a current gain factor,  $\beta$ , to give  $I_{RGD} = \beta \cdot I_{RG1}$ . Solving  $I_{RGD} = \beta \cdot (I_{LOAD})(R_{SENSE}) / R_{G1}$ . Assuming infinite output impedance,  $V_{OUT} = (I_{RGD})(R_{GD})$ . Substituting in for  $I_{RGD}$  and rearranging,  $V_{OUT} = \beta \cdot (R_{GD} / R_{G1})(R_{SENSE} \cdot I_{LOAD})$ . The parts gain equals  $\beta \cdot R_{GD} / R_{G1}$ . Therefore,  $V_{OUT} = (GAIN)(R_{SENSE})(I_{LOAD})$ , where  $GAIN = 20$  for MAX4173T,  $GAIN = 50$  for MAX4173F, and  $GAIN = 100$  for MAX4173H.

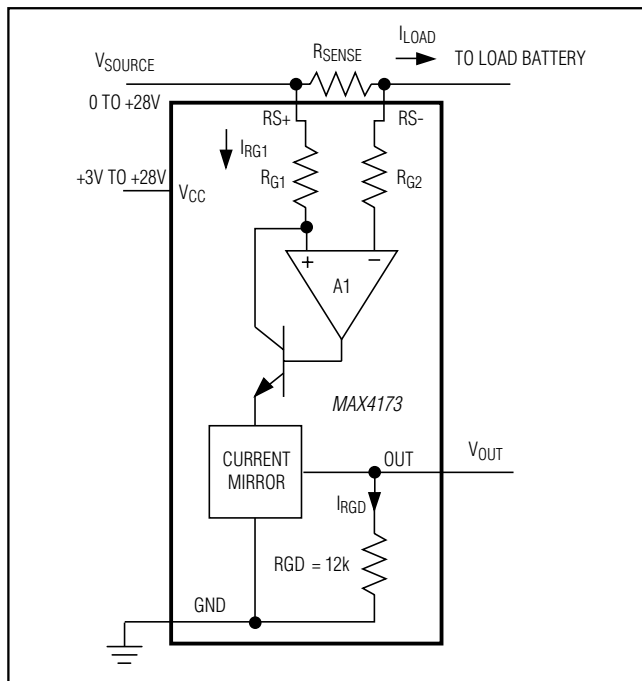

Figure 1. Functional Diagram

Set the full-scale output range by selecting  $R_{SENSE}$  and the appropriate gain version of the MAX4173.

### Applications Information

#### Recommended Component Values

The MAX4173 senses a wide variety of currents with different sense resistor values. Table 1 lists common resistor values for typical operation of the MAX4173.

#### Choosing $R_{SENSE}$

To measure lower currents more accurately, use a high value for  $R_{SENSE}$ . The high value develops a higher sense voltage that reduces offset voltage errors of the internal op amp.

In applications monitoring very high currents,  $R_{SENSE}$  must be able to dissipate the  $I^2R$  losses. If the resistor's rated power dissipation is exceeded, its value may drift or it may fail altogether, causing a differential voltage across the terminals in excess of the absolute maximum ratings.

If  $I_{SENSE}$  has a large high-frequency component, minimize the inductance of  $R_{SENSE}$ . Wire-wound resistors have the highest inductance, metal-film resistors are somewhat better, and low-inductance metal-film resistors are best suited for these applications.

#### Using a PCB Trace as $R_{SENSE}$

If the cost of  $R_{SENSE}$  is an issue and accuracy is not critical, use the alternative solution shown in Figure 2. This solution uses copper PC board traces to create a sense resistor. The resistivity of a 0.1-inch-wide trace of 2-ounce copper is approximately  $30\text{m}\Omega/\text{ft}$ . The resistance-temperature coefficient of copper is fairly high (approximately  $0.4\%/^{\circ}\text{C}$ ), so systems that experience a wide temperature variance must compensate for this effect. In addition, do not exceed the maximum power dissipation of the copper trace.

For example, the MAX4173T (with a maximum load current of 10A and an  $R_{SENSE}$  of  $5\text{m}\Omega$ ) creates a full-scale  $V_{SENSE}$  of 50mV that yields a maximum  $V_{OUT}$  of 1V.  $R_{SENSE}$  in this case requires about 2 inches of 0.1 inch-wide copper trace.

#### Output Impedance

The output of the MAX4173 is a current source driving a  $12\text{k}\Omega$  resistance. Resistive loading added to  $OUT$  reduces the output gain of the MAX4173. To minimize output errors for most applications, connect  $OUT$  to a high-impedance input stage. When output buffering is required, choose an op amp with a common-mode input range and an output voltage swing that includes ground when operating with a single supply. The op

# MAX4173

## Low-Cost, SOT23, Voltage-Output, High-Side Current-Sense Amplifier

Table 1. Recommended Component Values

FULL-SCALE LOAD CURRENT $I_{LOAD}$ (A)	CURRENT-SENSE RESISTOR $R_{SENSE}$ (m $\Omega$ )	GAIN	FULL-SCALE OUTPUT VOLTAGE (FULL-SCALE $V_{SENSE} = 100\text{mV}$ ) $V_{OUT}$ (V)
0.1	1000	20	2.0
		50	5.0
		100	10.0
1	100	20	2.0
		50	5.0
		100	10.0
5	20	20	2.0
		50	5.0
		100	10.0
10	10	20	2.0
		50	5.0
		100	10.0

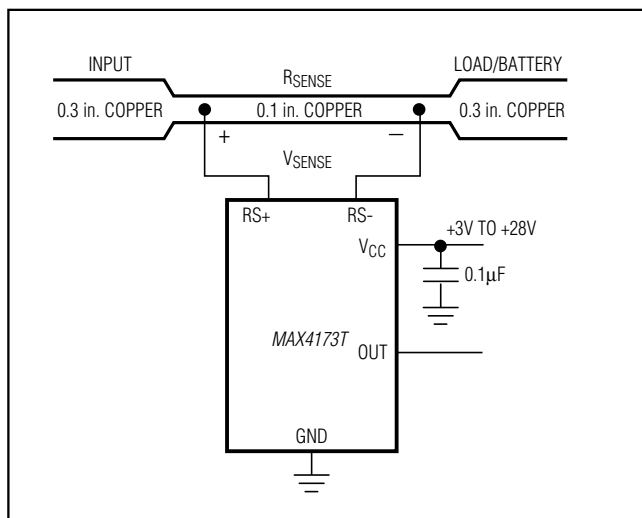

Figure 2. MAX4173 Connections Showing Use of PC Board

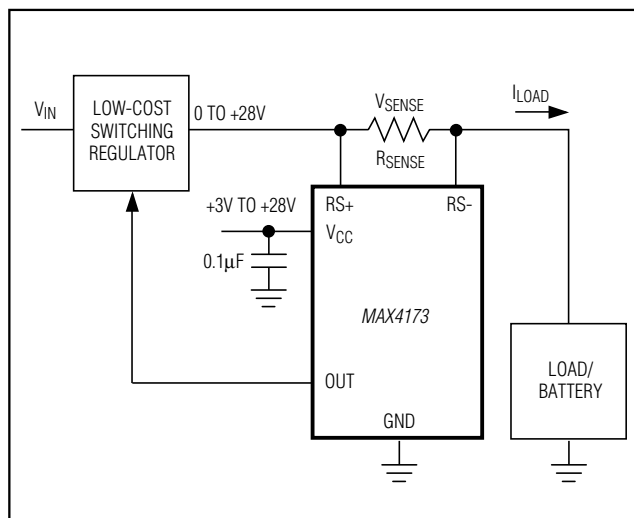

Figure 3. Current Source

amp's supply voltage range should be at least as high as any voltage the system may encounter.

The percent error introduced by output loading is determined with the following formula:

$$\%ERROR = 100 \left( \frac{R_{LOAD}}{12k\Omega + R_{LOAD}} - 1 \right)$$

where  $R_{LOAD}$  is the external load applied to OUT.

### Current Source Circuit

Figure 3 shows a block diagram using the MAX4173 with a switching regulator to make a current source.

# MAX4173

## Low-Cost, SOT23, Voltage-Output, High-Side Current-Sense Amplifier

### Pin Configurations

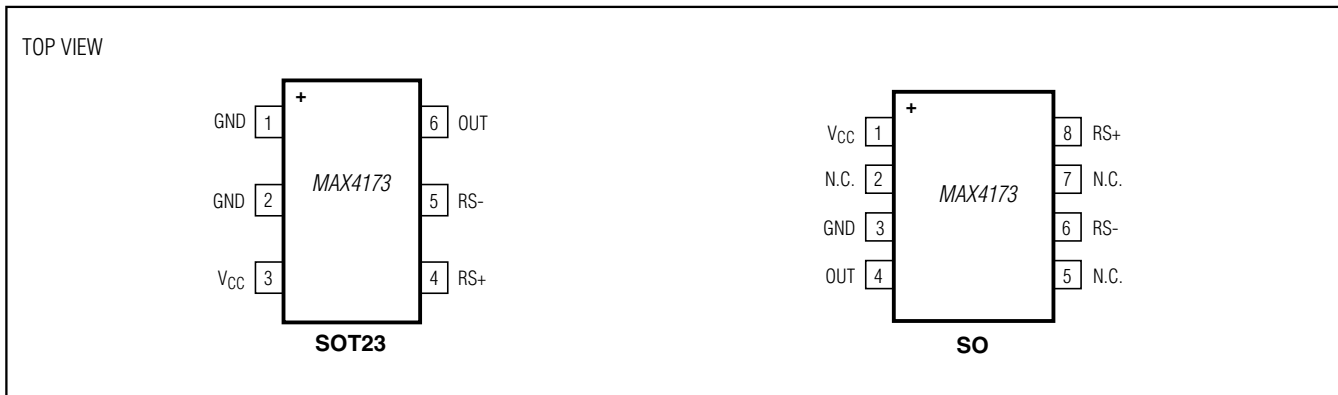

### Package Information

For the latest package outline information and land patterns (footprints), go to [www.maxim-ic.com/packages](http://www.maxim-ic.com/packages). Note that a "+", "#", or "-" in the package code indicates RoHS status only. Package drawings may show a different suffix character, but the drawing pertains to the package regardless of RoHS status.

PACKAGE TYPE	PACKAGE CODE	OUTLINE NO.	LAND PATTERN NO.
8 SO	S8+4	<a href="#">21-0041</a>	<a href="#">90-0096</a>
6 SOT23	U6+2	<a href="#">21-0058</a>	<a href="#">90-0175</a>



# MAX4173

## Low-Cost, SOT23, Voltage-Output, High-Side Current-Sense Amplifier

### Revision History

REVISION NUMBER	REVISION DATE	DESCRIPTION	PAGES CHANGED
4	6/10	Clarified 0V to 2V is not a high-accuracy range for the device, added lead-free options and soldering temperature	1, 2
5	4/11	Updated $V_{RS+}$ conditions to synchronize with tested material	2, 3



Maxim cannot assume responsibility for use of any circuitry other than circuitry entirely embodied in a Maxim product. No circuit patent licenses are implied. Maxim reserves the right to change the circuitry and specifications without notice at any time. The parametric values (min and max limits) shown in the Electrical Characteristics table are guaranteed. Other parametric values quoted in this data sheet are provided for guidance.

# Mouser Electronics

Authorized Distributor

Click to View Pricing, Inventory, Delivery & Lifecycle Information:

## Maxim Integrated:

[MAX4173FESA+](#) [MAX4173HESA+](#) [MAX4173TESA+](#) [MAX4173FESA](#) [MAX4173FESA+T](#) [MAX4173FEUT+T](#)  
[MAX4173FEUT-T](#) [MAX4173HESA](#) [MAX4173HESA+T](#) [MAX4173HEUT+T](#) [MAX4173HEUT-T](#) [MAX4173TESA](#)  
[MAX4173TESA+T](#) [MAX4173TEUT+T](#) [MAX4173TEUT-T](#) [MAX4173FESA-T](#) [MAX4173HESA-T](#) [MAX4173TESA-T](#)