

ORDERING INFORMATION

PART NO.	PART NO. SUFFIX	PACKING CODE	PACKING CODE SUFFIX (*)	PACKAGE	PACKING
SRAF8xx (Note 1)	H	C0	G	ITO-220AC	50 / Tube

Note 1: "xx" defines voltage from 20V (SRAF820) to 150V (SRAF8150)

*: Optional available

EXAMPLE

EXAMPLE P/N	PART NO.	PART NO. SUFFIX	PACKING CODE	PACKING CODE SUFFIX	DESCRIPTION
SRAF860HC0G	SRAF860	H	C0	G	AEC-Q101 qualified Green compound

RATINGS AND CHARACTERISTICS CURVES

(T_A=25°C unless otherwise noted)

FIG.1 MAXIMUM FORWARD CURRENT DERATING CURVE

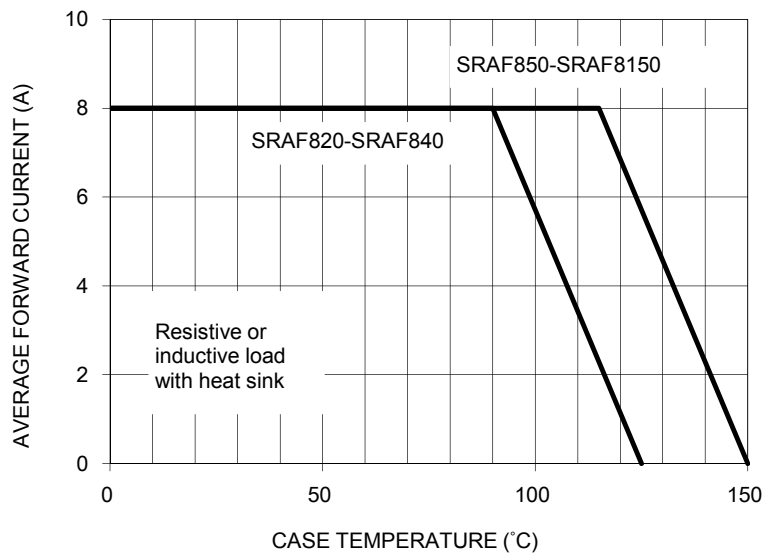

FIG. 2 MAXIMUM NON-REPETITIVE FORWARD SURGE CURRENT

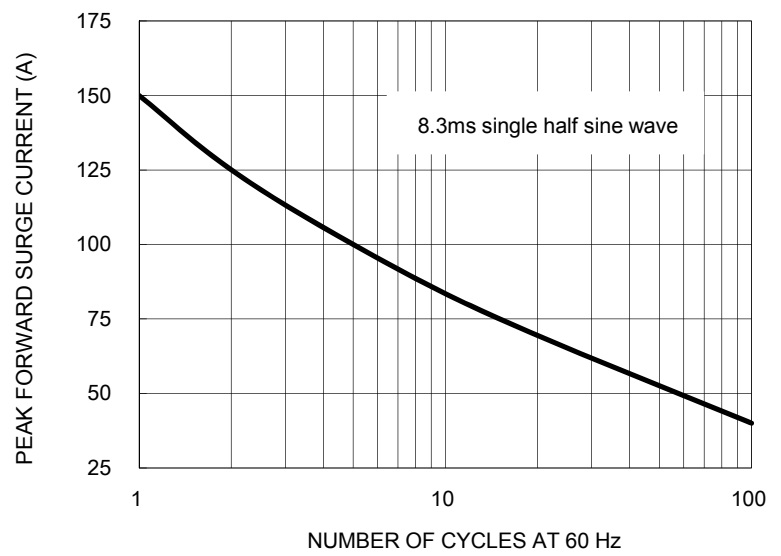

FIG. 3 TYPICAL FORWARD CHARACTERISTICS

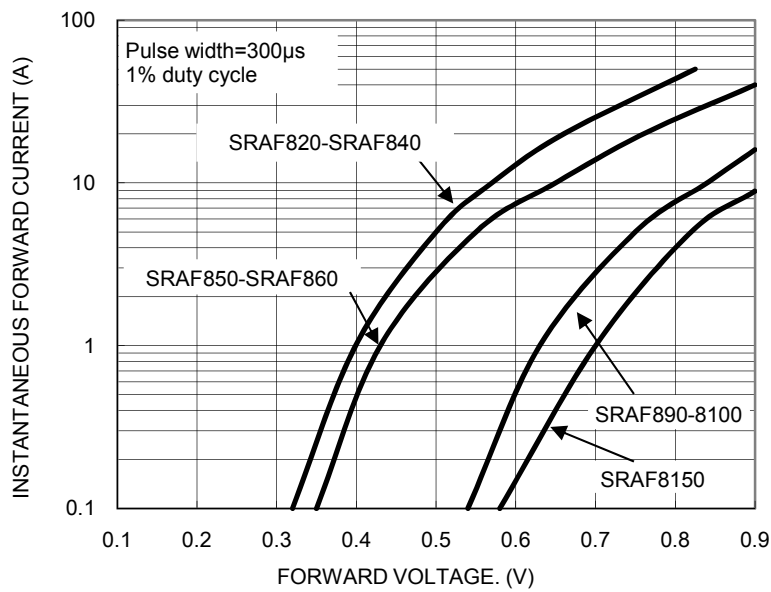

FIG. 4 TYPICAL REVERSE CHARACTERISTICS

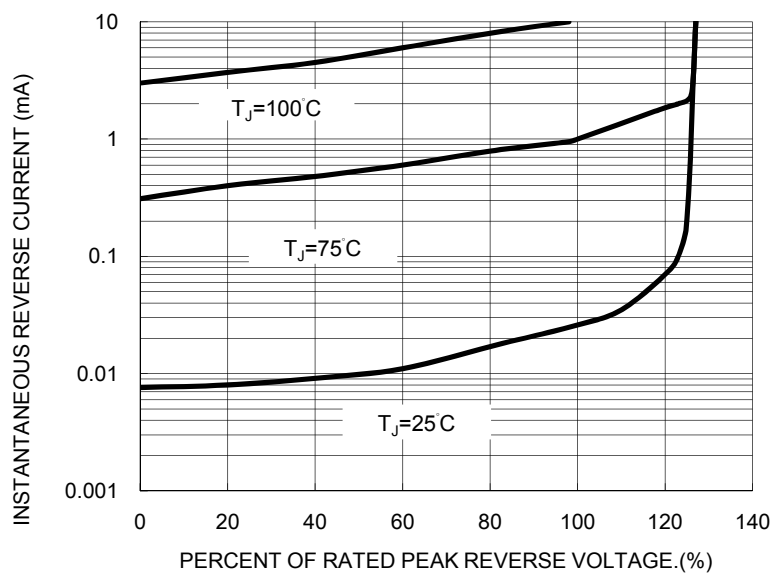

FIG. 5 TYPICAL JUNCTION CAPACITANCE

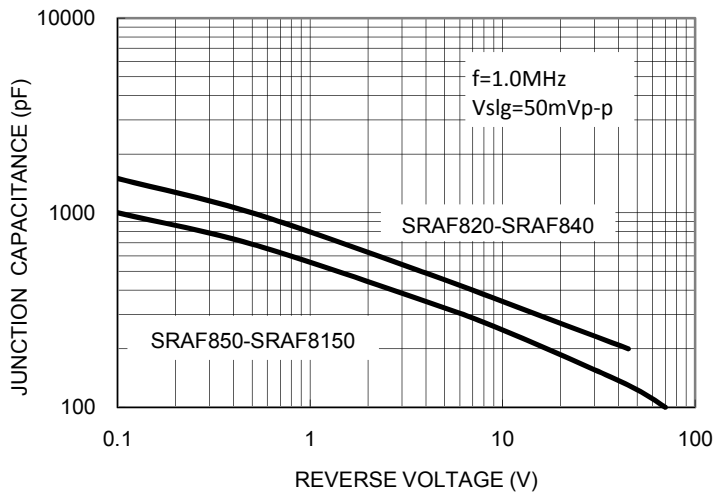
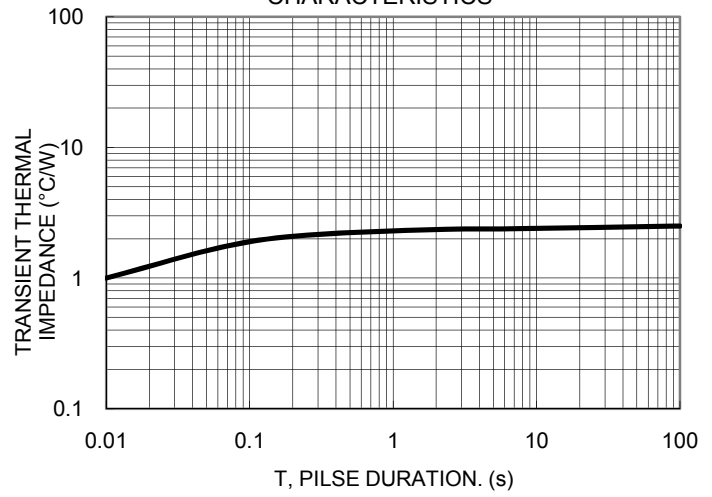
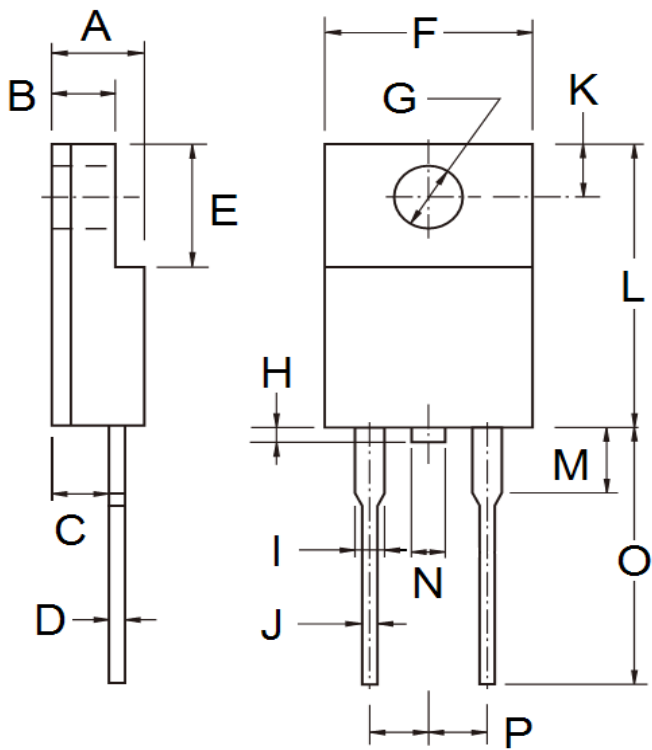

FIG. 6 TYPICAL TRANSIENT THERMAL CHARACTERISTICS



PACKAGE OUTLINE DIMENSIONS

ITO-220AC



DIM.	Unit (mm)		Unit (inch)	
	Min	Max	Min	Max
A	4.30	4.70	0.169	0.185
B	2.50	3.10	0.098	0.122
C	2.30	2.90	0.091	0.114
D	0.46	0.76	0.018	0.030
E	6.30	6.90	0.248	0.272
F	9.60	10.30	0.378	0.406
G	3.00	3.40	0.118	0.134
H	0.00	1.60	0.000	0.063
I	0.95	1.45	0.037	0.057
J	0.50	0.90	0.020	0.035
K	2.40	3.20	0.094	0.126
L	14.80	15.50	0.583	0.610
M	-	4.10	-	0.161
N	-	1.80	-	0.071
O	12.60	13.80	0.496	0.543
P	4.95	5.20	0.195	0.205

MARKING DIAGRAM



- P/N = Specific Device Code
- G = Green Compound
- YWW = Date Code
- F = Factory Code

Notice

Specifications of the products displayed herein are subject to change without notice. TSC or anyone on its behalf, assumes no responsibility or liability for any errors or inaccuracies.

Information contained herein is intended to provide a product description only. No license, express or implied, to any intellectual property rights is granted by this document. Except as provided in TSC's terms and conditions of sale for such products, TSC assumes no liability whatsoever, and disclaims any express or implied warranty, relating to sale and/or use of TSC products including liability or warranties relating to fitness for a particular purpose, merchantability, or infringement of any patent, copyright, or other intellectual property right.

The products shown herein are not designed for use in medical, life-saving, or life-sustaining applications. Customers using or selling these products for use in such applications do so at their own risk and agree to fully indemnify TSC for any damages resulting from such improper use or sale.

Mouser Electronics

Authorized Distributor

Click to View Pricing, Inventory, Delivery & Lifecycle Information:

Taiwan Semiconductor:

[SRAF8100](#) [SRAF820](#) [SRAF830](#) [SRAF840](#) [SRAF850](#) [SRAF860](#) [SRAF890](#) [SRAF840 C0](#) [SRAF830 C0](#) [SRAF890 C0](#) [SRAF8100 C0](#) [SRAF860 C0](#) [SRAF820 C0](#) [SRAF850 C0](#)