

Electrical Characteristics

(Unless otherwise specified, condition shall be $V_C=2.7V, I_O=0.3A$ [PQxxDZ51J00H series/PQ3DZ53J000H], $I_O=0.5A$ [PQxxDZ11J00H series/PQ3DZ13J000H], $T_a=25^\circ C$)

Parameter	Symbol	Conditions	MIN.	TYP.	MAX.	Unit	
Output voltage	V_O	*4	PQ3DZ53J000H/PQ3DZ13J000H	3.201	3.3	3.399	V
			PQ05DZ51J00H/PQ05DZ11J00H	4.85	5.0	5.15	
			PQ09DZ51J00H/PQ09DZ11J00H	8.73	9.0	9.27	
			PQ12DZ51J00H/PQ12DZ11J00H	11.64	12.0	12.36	
Load regulation	R_{regL}	PQxxDZ51J00H series	$I_O=5mA$ to $0.5A$ *4	—	*8 0.2	2.0	%
		PQxxDZ11J00H series	$I_O=5mA$ to $1.0A$ *4	—			
Line regulation	R_{regI}	*5, $I_O=5mA$	—	*8 0.1	2.5	%	
Temperature coefficient of output voltage	$T_C V_O$	$T_j=0$ to $125^\circ C, I_O=5mA, *$ 4	—	*9 ± 0.01	—	%/ $^\circ C$	
Ripple Rejection	RR	Refer to Fig.2	45	60	—	dB	
Dropout voltage	V_{I-O}	*6, $I_O=0.3A$	—	*8 0.2	0.5	V	
		*6, $I_O=0.5A$	—				
*7 ON-state voltage for control	$V_{C(ON)}$	*4	2.0	—	—	V	
ON-state current for control	$I_{C(ON)}$	*4	—	—	200	μA	
OFF-state voltage for control	$V_{C(OFF)}$	$I_O=0A, *$ 4	—	—	0.8	V	
OFF-state current for control	$I_{C(OFF)}$	$V_C=0.4V, I_O=0A, *$ 4	—	—	2	μA	
Quiescent current	I_q	$I_O=0A, *$ 4	—	*8 4	10	mA	
Output OFF-state dissipation current	I_{qs}	$V_C=0.4V, I_O=0A, *$ 4	—	—	5	μA	

*4 PQ3DZ53J000H/PQ3DZ13J000H: $V_{IN}=5V, PQ05DZ51J00H/11J00H: V_{IN}=7V, PQ09DZ51J00H/11J00H: V_{IN}=11V, PQ12DZ51J00H/11J00H: V_{IN}=14V$

*5 PQ3DZ53J000H/13J000H: $V_{IN}=4$ to $10V, PQ05DZ51J00H/11J00H: V_{IN}=6$ to $16V, PQ09DZ51J00H/11J00H: V_{IN}=10$ to $20V, PQ12DZ51J00H/11J00H: V_{IN}=13$ to $23V$

*6 Input voltage shall be the value when output voltage is 95% in comparison with the initial value. PQ3DZ53J000H/13J000H: $V_{IN}=3.7V$

*7 In case of opening control terminal ②, output voltage turns off.

*8 Applied only to PQ05DZ51J00H/11J00H.

*9 PQ3DZ53J000H/PQ3DZ13J000H: ± 0.02

Fig.1 Test Circuit

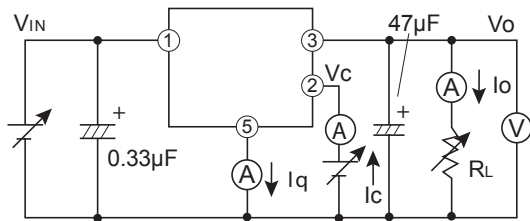

Fig.2 Test Circuit for Ripple Rejection

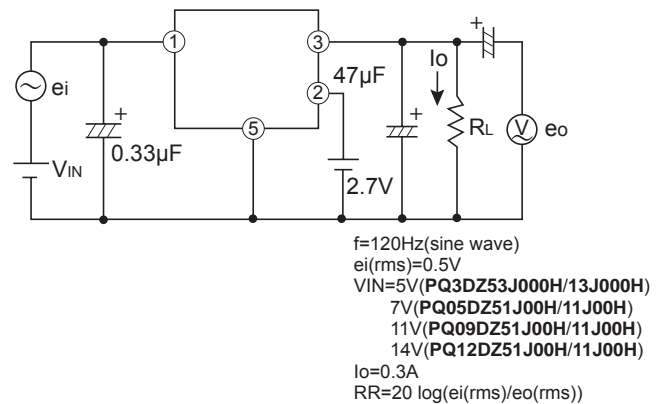
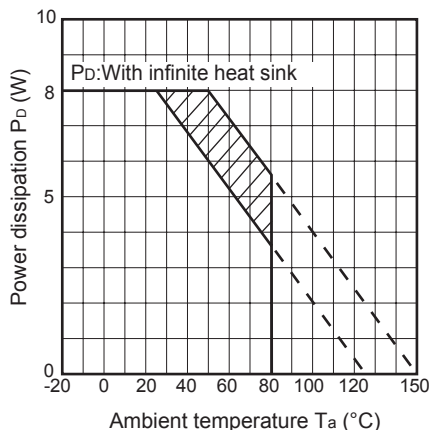

Fig.3 Power Dissipation vs. Ambient Temperature



Note) Oblique line portion: Overheat protection may operate in this area.

Fig.4 Overcurrent Protection Characteristics (Typical Value) (PQ3DZ53J000H)

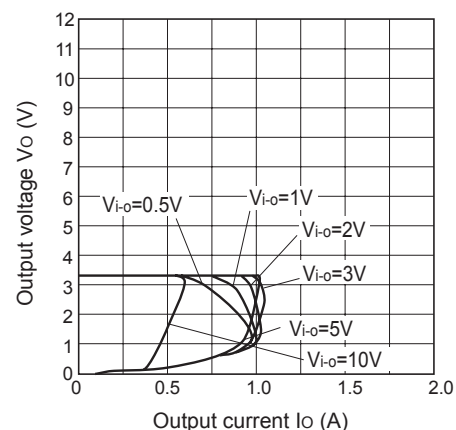

Fig.5 Overcurrent Protection Characteristics (Typical Value) (PQ3DZ13J000H)

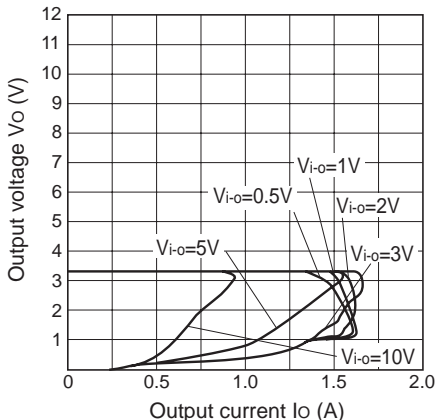

Fig.6 Overcurrent Protection Characteristics (Typical Value) (PQ05DZ51J00H)

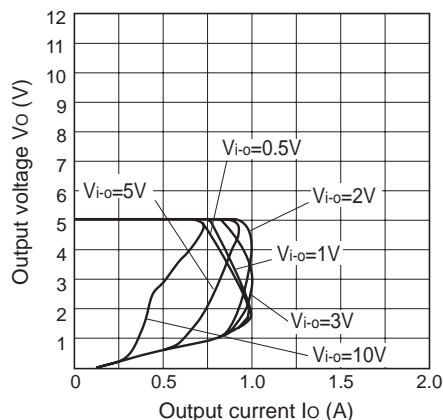

Fig.7 Overcurrent Protection Characteristics (Typical Value) (PQ09DZ51J00H)

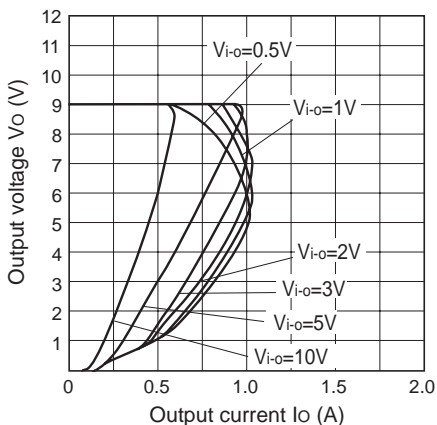

Fig.8 Overcurrent Protection Characteristics (Typical Value) (PQ12DZ51J00H)

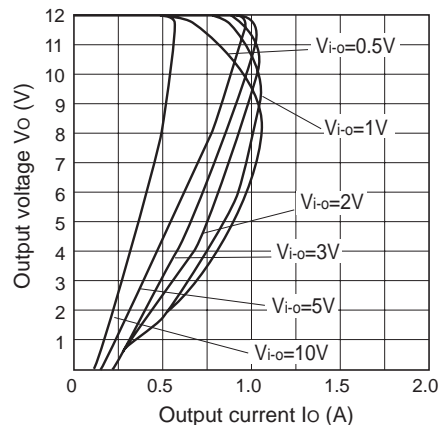

Fig.9 Overcurrent Protection Characteristics (Typical Value) (PQ05DZ11J00H)

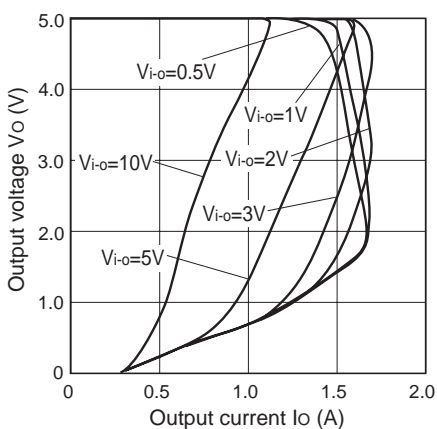

Fig.10 Overcurrent Protection Characteristics (Typical Value) (PQ09DZ11J00H)

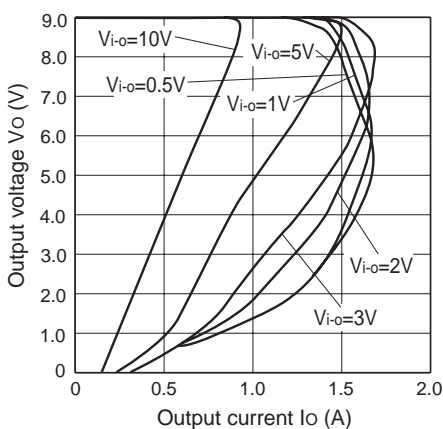

Fig.11 Overcurrent Protection Characteristics (Typical Value) (PQ12DZ11J00H)

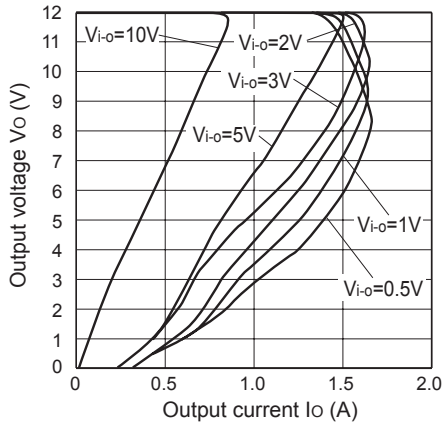
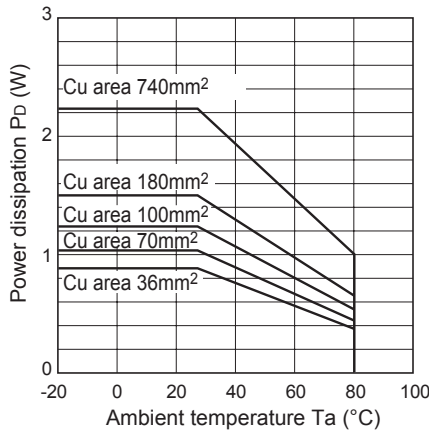
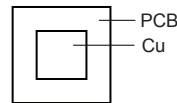

Fig.12 Power Dissipation vs. Ambient Temperature (Typical Value)



Mounting PCB



Material : Glass-cloth epoxy resin
Size : 50×50×1.6mm
Cu thickness : 35μm

Fig.13 Output Voltage Deviation vs. Junction Temperature (PQ3DZ53J000H/PQ3DZ13J000H)

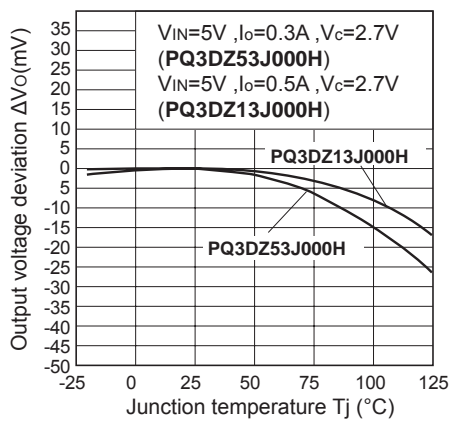

Fig.14 Output Voltage Deviation vs. Junction Temperature (PQ05DZ51J00H/PQ05DZ11J00H)

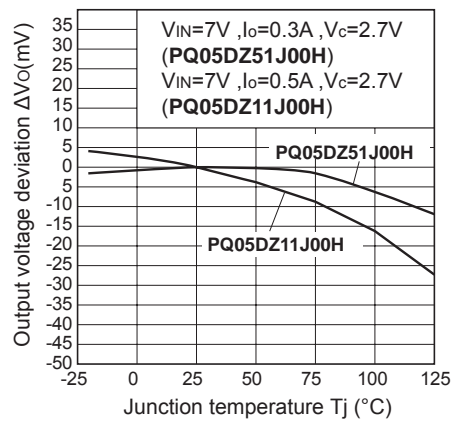

Fig.15 Output Voltage Deviation vs. Junction Temperature (PQ09DZ51J00H/PQ09DZ11J00H)

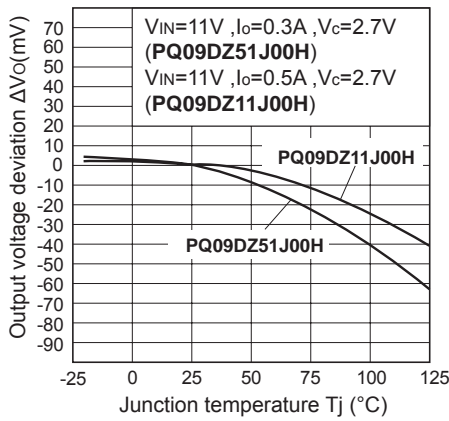

Fig.16 Output Voltage Deviation vs. Junction Temperature (PQ12DZ51J00H/PQ12DZ11J00H)

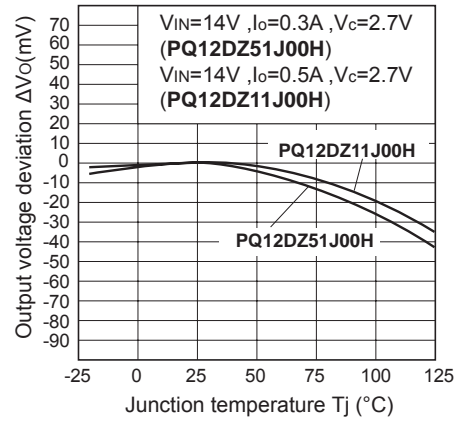

Fig.17 Output Voltage vs. Input Voltage (Typical Value) (PQ3DZ53J000H)

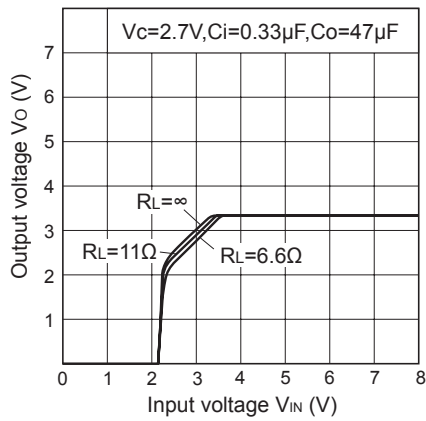

Fig.18 Output Voltage vs. Input Voltage (Typical Value) (PQ05DZ51J00H)

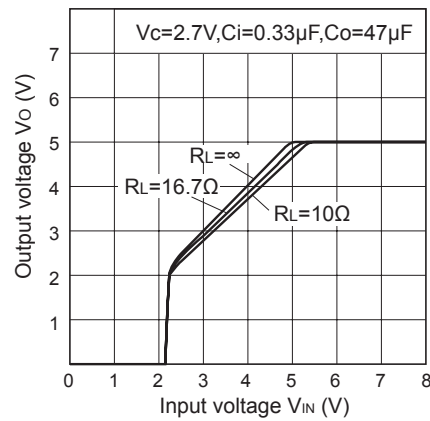

Fig.19 Output Voltage vs. Input Voltage (Typical Value) (PQ09DZ51J00H)

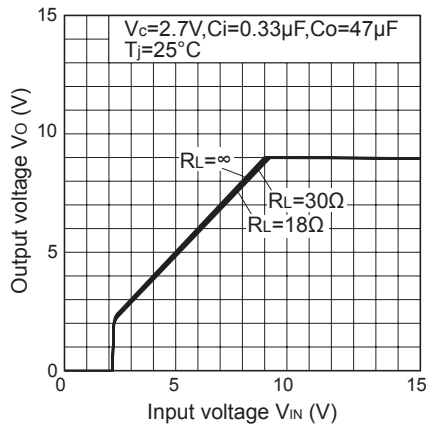

Fig.20 Output Voltage vs. Input Voltage (Typical Value) (PQ12DZ51J00H)

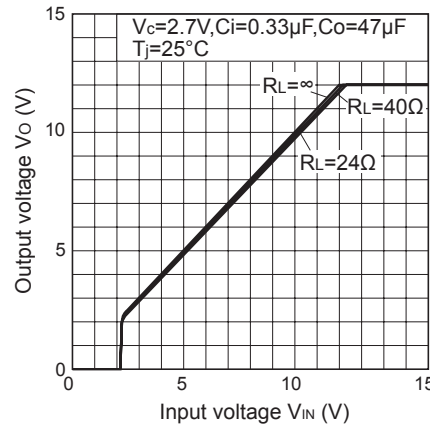

Fig.21 Output Voltage vs. Input Voltage (Typical Value) (PQ3DZ13J000H)

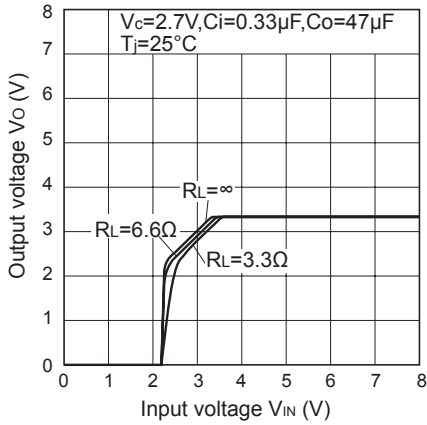

Fig.22 Output Voltage vs. Input Voltage (Typical Value) (PQ05DZ11J00H)

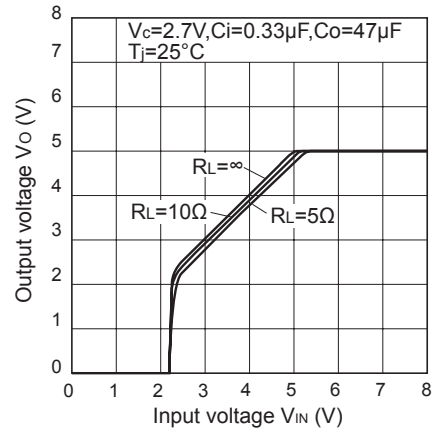

Fig.23 Output Voltage vs. Input Voltage (Typical Value) (PQ09DZ11J00H)

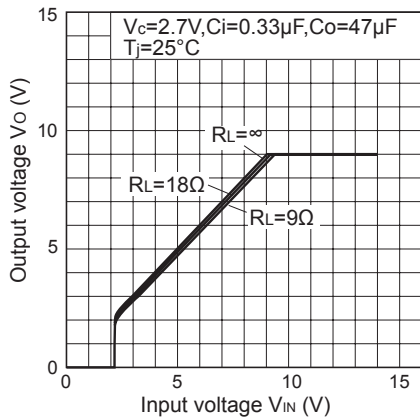

Fig.24 Output Voltage vs. Input Voltage (Typical Value) (PQ12DZ11J00H)

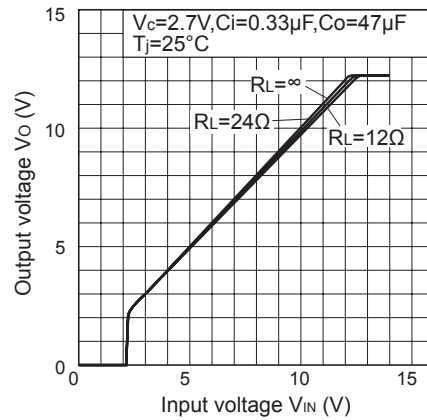

Fig.25 Circuit Operating Current vs. Input Voltage (PQ3D53J000H)

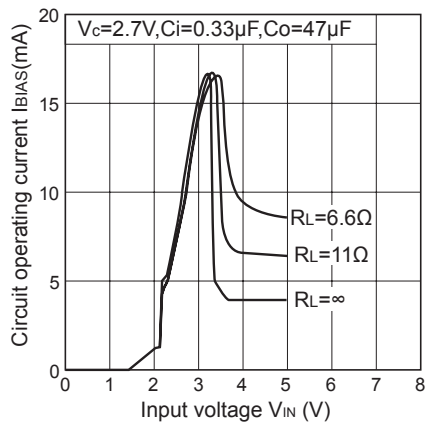

Fig.26 Circuit Operating Current vs. Input Voltage (PQ05D51J00H)

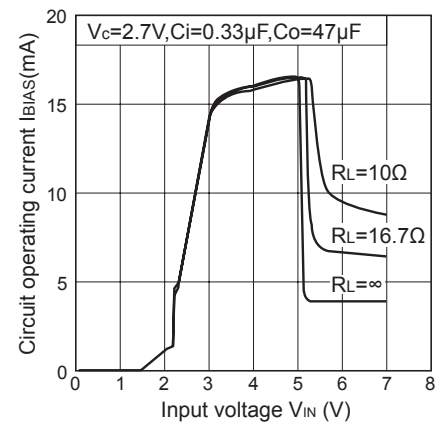

Fig.27 Circuit Operating Current vs. Input Voltage(PQ09DZ51J00H)

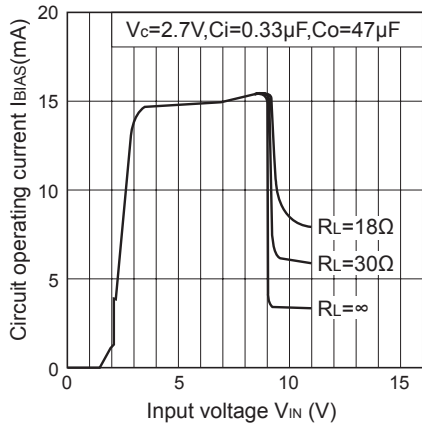

Fig.28 Circuit Operating Current vs. Input Voltage(PQ12DZ51J00H)

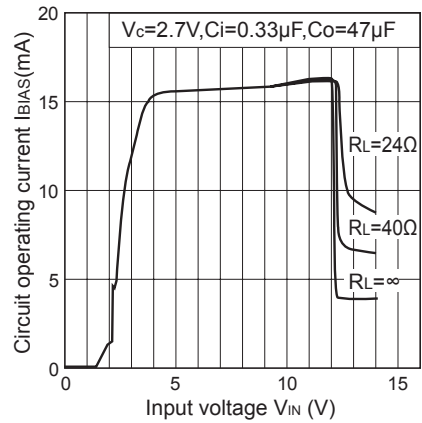

Fig.29 Circuit Operating Current vs. Input Voltage(PQ3DZ13J000H)

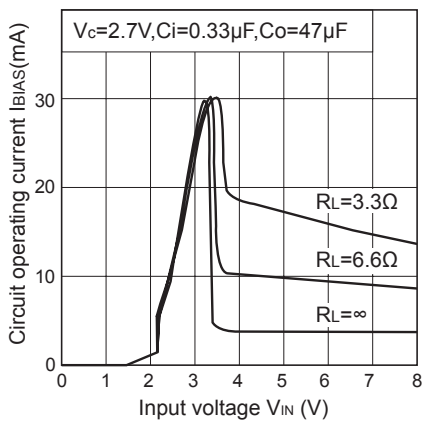

Fig.30 Circuit Operating Current vs. Input Voltage(PQ05DZ11J00H)

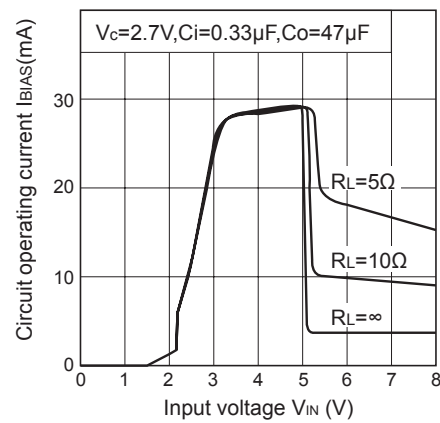

Fig.31 Circuit Operating Current vs. Input Voltage(PQ09DZ11J00H)

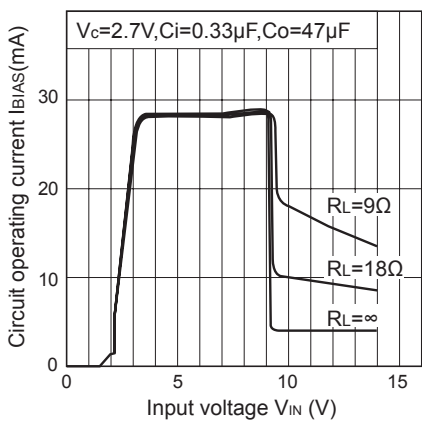

Fig.32 Circuit Operating Current vs. Input Voltage(PQ12DZ11J00H)

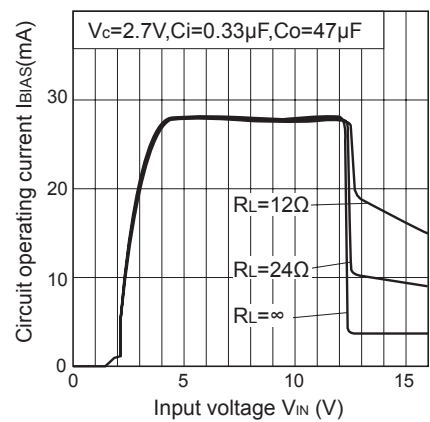

Fig.33 Dropout Voltage vs. Junction Temperature (PQxxDZ51J00H series/PD3DZ53J000H)

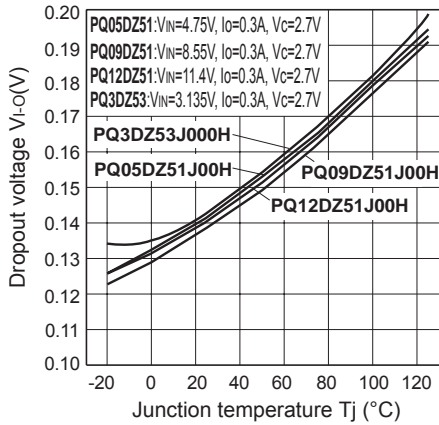

Fig.34 Dropout Voltage vs. Junction Temperature (PQxxDZ11J00H series/PD3DZ13J000H)

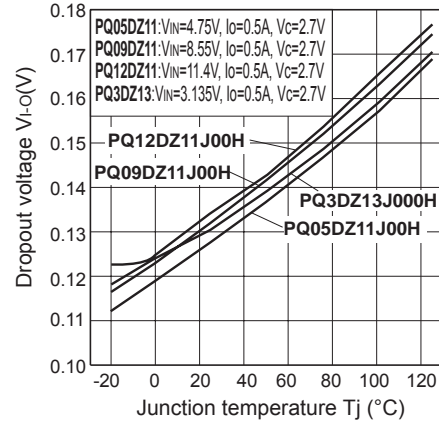

Fig.35 Quiescent Current vs. Junction Temperature (PQxxDZ51J00H series/PQ3DZ53J000H)

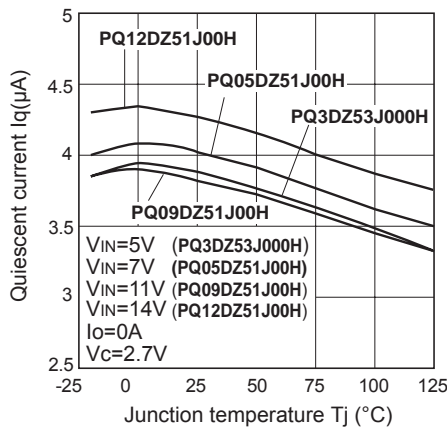

Fig.36 Quiescent Current vs. Junction Temperature (PQxxDZ11J00H series/PQ3DZ13J000H)

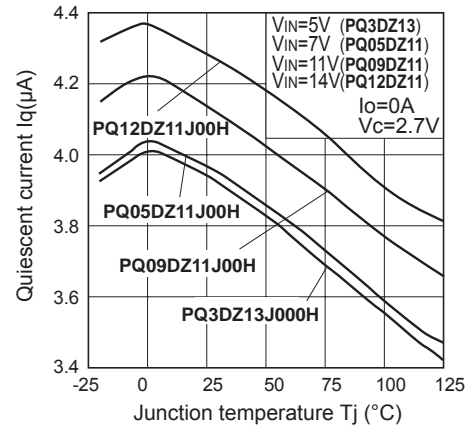

Fig.37 Ripple Rejection vs. Input Ripple Frequency (PQxxDZ51J00H series/PQ3DZ53J000H)

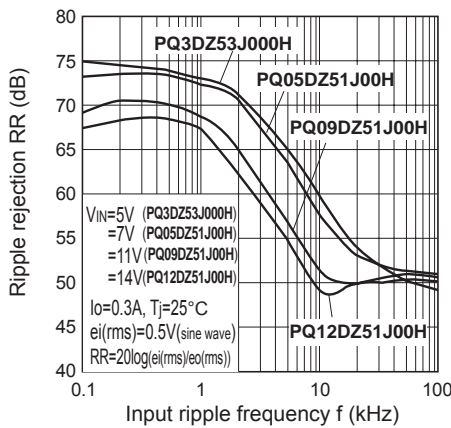

Fig.38 Ripple Rejection vs. Input Ripple Frequency (PQxxDZ11J00H series/PQ3DZ13J000H)

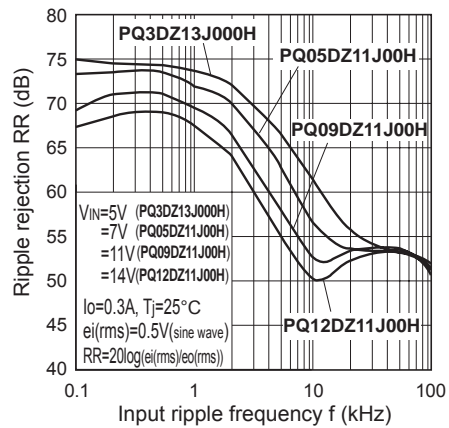

Fig.39 Ripple Rejection vs. Output Current
(PQxxDZ51J00H series/PQ3DZ53J000H)

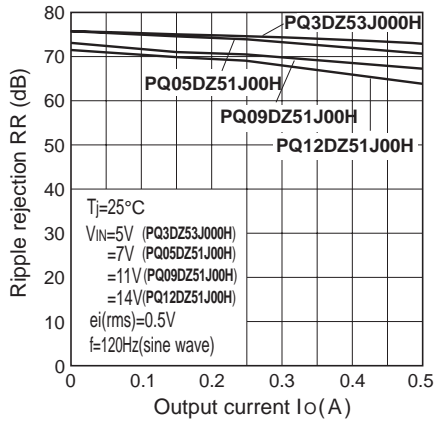
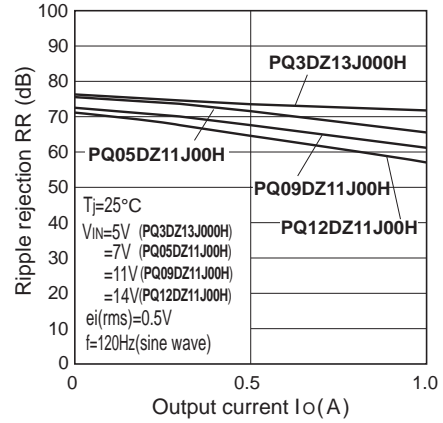

Fig.40 Ripple Rejection vs. Output Current
(PQxxDZ11J00H series/PQ3DZ13J000H)



■ Typical Application

