

# RF/Microwave Capacitors

## RF/Microwave Multilayer Capacitors (MLC)

### 600S Ultra-Low ESR, High Q, NPO Capacitors



## CAPACITANCE VALUES

Value (pF)	Cap Code	Marking	Tolerances	Value (pF)	Cap Code	Marking	Tolerances	Value (pF)	Cap Code	Marking	Tolerances
0.1	0R1	A9	A, B	2.7	2R7	L0	A, B, C, D	20	200	H1	F, G, J, K, M
0.2	0R2	H9	A, B	3.0	3R0	M0	A, B, C, D	22	220	J1	F, G, J, K, M
0.3	0R3	M9	A, B, C	3.3	3R3	N0	A, B, C, D	24	240	K1	F, G, J, K, M
0.4	0R4	d9	A, B, C	3.6	3R6	P0	A, B, C, D	27	270	L1	F, G, J, K, M
0.5	0R5	f9	A, B, C	3.9	3R9	Q0	A, B, C, D	30	300	M1	F, G, J, K, M
0.6	0R6	m9	A, B, C	4.3	4R3	R0	A, B, C, D	33	330	N1	F, G, J, K, M
0.7	0R7	n9	A, B, C	4.7	4R7	S0	A, B, C, D	36	360	P1	F, G, J, K, M
0.8	0R8	t9	A, B, C	5.1	5R1	T0	A, B, C, D	39	390	Q1	F, G, J, K, M
0.9	0R9	y9	A, B, C	5.6	5R6	U0	A, B, C, D	43	430	R1	F, G, J, K, M
1.0	1R0	A0	A, B, C, D	6.2	6R2	V0	A, B, C, D	47	470	S1	F, G, J, K, M
1.1	1R1	B0	A, B, C, D	6.8	6R8	W0	B, C, J, K	51	510	T1	F, G, J, K, M
1.2	1R2	C0	A, B, C, D	7.5	7R5	X0	B, C, J, K	56	560	U1	F, G, J, K, M
1.3	1R3	D0	A, B, C, D	8.2	8R2	Y0	B, C, J, K	62	620	V1	F, G, J, K, M
1.5	1R5	E0	A, B, C, D	9.1	9R1	Z0	B, C, J, K	68	680	W1	F, G, J, K, M
1.6	1R6	F0	A, B, C, D	10	100	A1	F, G, J, K, M	75	750	X1	F, G, J, K, M
1.8	1R8	G0	A, B, C, D	11	110	B1	F, G, J, K, M	82	820	Y1	F, G, J, K, M
2.0	2R0	H0	A, B, C, D	12	120	C1	F, G, J, K, M	91	910	Z1	F, G, J, K, M
2.2	2R2	J0	A, B, C, D	15	150	E1	F, G, J, K, M	100	101	A2	F, G, J, K, M
2.4	2R4	K0	A, B, C, D	18	180	G1	F, G, J, K, M				

## HOW TO ORDER

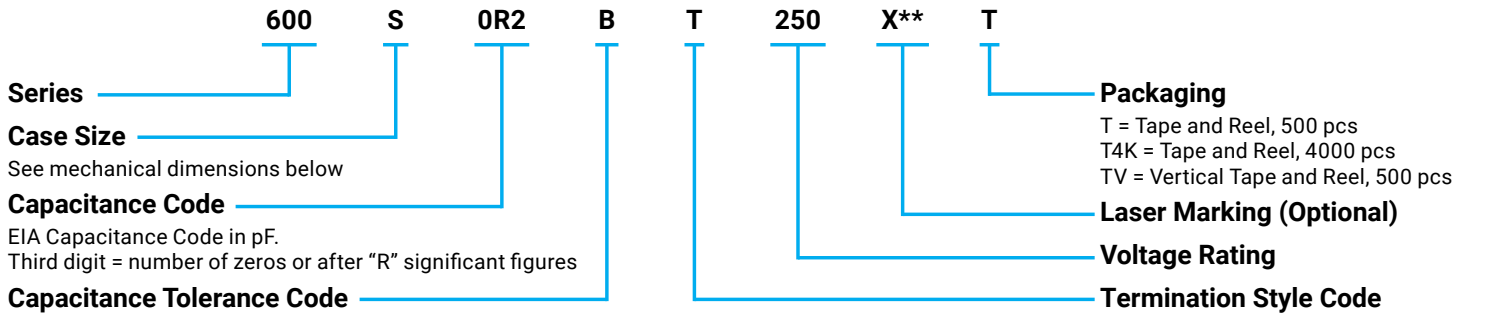

Code	A	B	C	D	F	G	J	K	M
<b>Tol.</b>	±0.05 pF	±0.1 pF	±0.25 pF	±0.5 pF	±1%	±2%	±5%	±10%	±20%

The above part number refers to a 600F Series (case size F) 10 pF capacitor, J tolerance (±5%), 250 WVDC, with T termination (Tin Plated over Nickel Barrier, RoHS Compliant), Laser Marking and Tape and Reel packaging.

\*\*Laser Marking is optional

**600S ESR vs Capacitance**

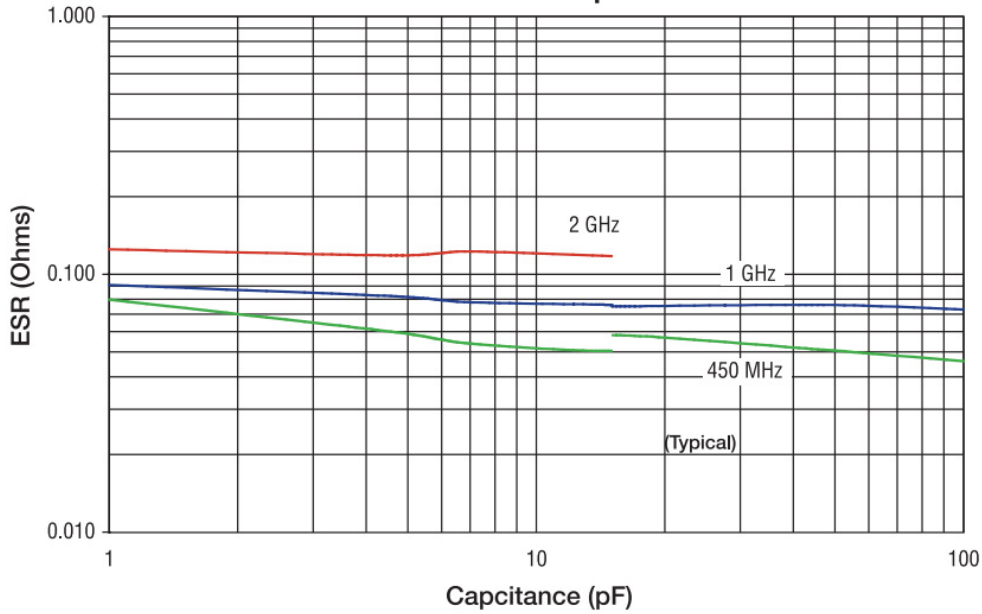

**600S ESR vs Frequency**

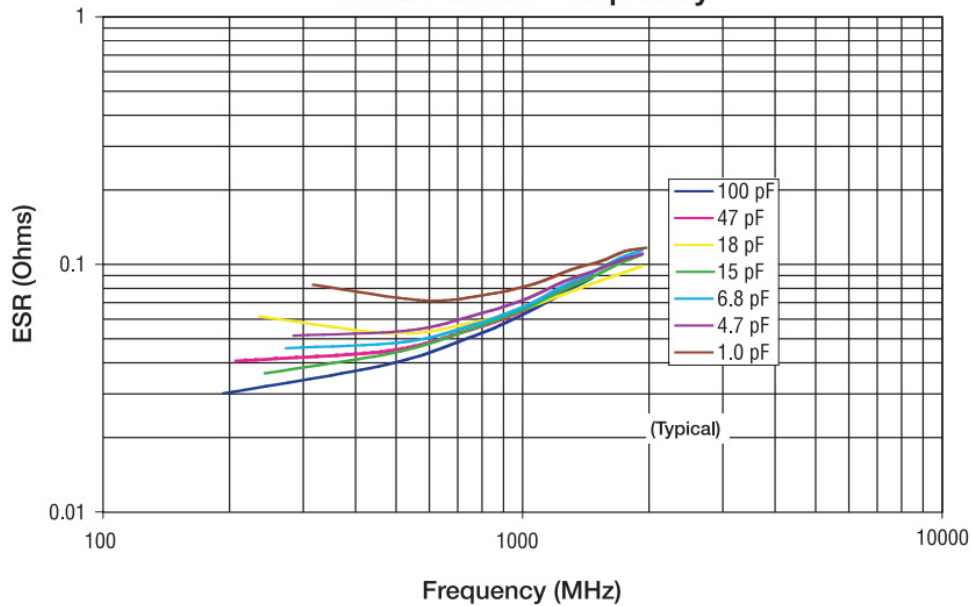

**RF/Microwave Capacitors**  
**RF/Microwave Multilayer Capacitors (MLC)**  
**600S Ultra-Low ESR, High Q, NPO Capacitors**

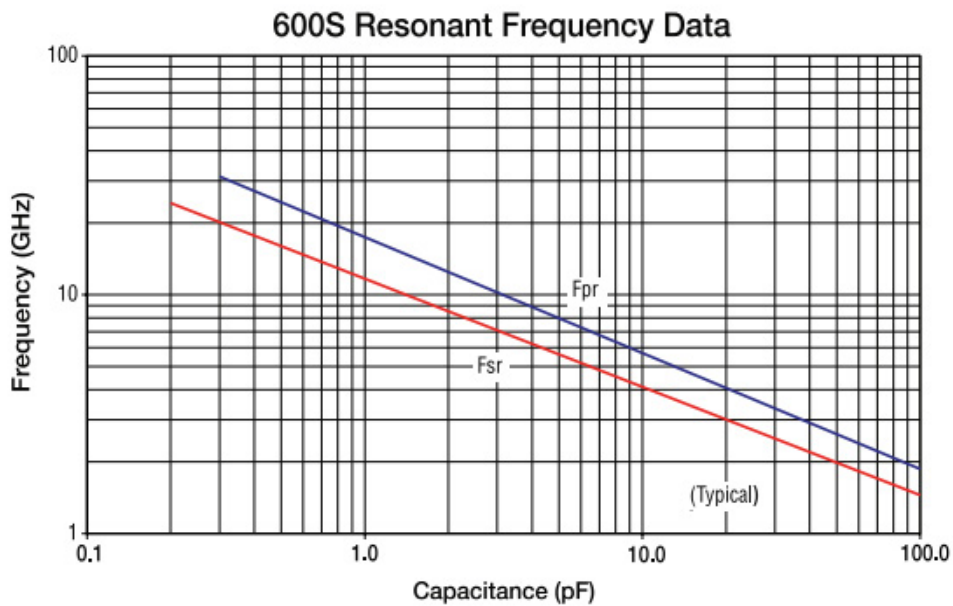
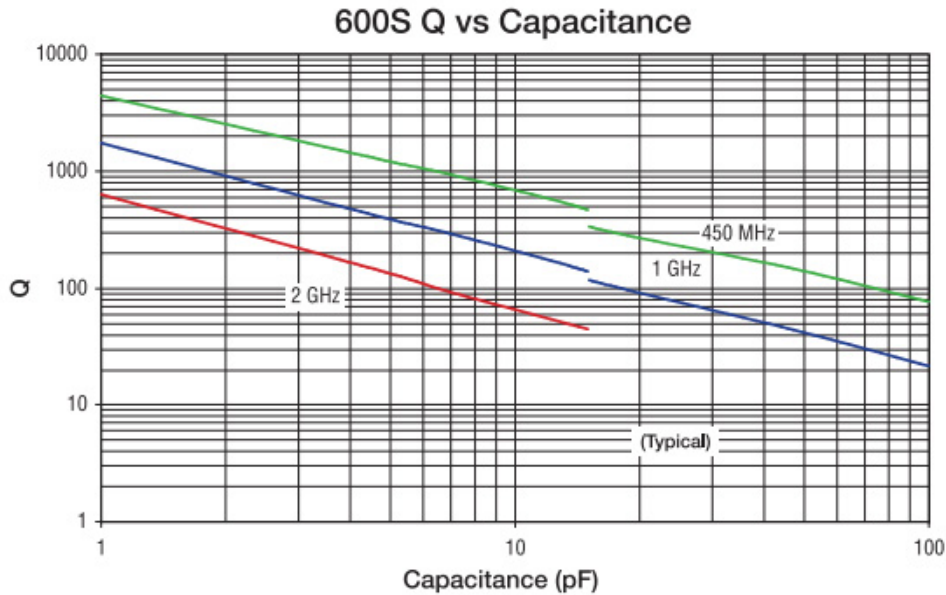

**AVX 600F Series Data Sheet Condition Description**

Capacitors horizontally mounted on 13.3-mil thick Rogers R0435® softboard 29-mils wide 1/2 oz. Cu traces  
**FSR** = lowest frequency at which S11 response, referenced at capacitor edge, crosses real axis on Smith Chart.  
**FPR** = lowest frequency at which there is a notch in S21 magnitude response.

# RF/Microwave Capacitors

## RF/Microwave Multilayer Capacitors (MLC)

### 600S Ultra-Low ESR, High Q, NPO Capacitors

## OUTLINE DIMENSIONS

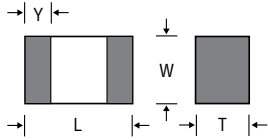

<b>S (0603)</b>	L: $.063 \pm .006$ (1.60 $\pm$ 0.15)	T: .035 max (0.89 max)
	W: $.032 \pm .006$ (.81 $\pm$ 0.15)	Y: $.014 \pm .006$ (0.36 $\pm$ 0.15)

inches (mm)

## SUGGESTED MOUNTING PAD DIMENSIONS

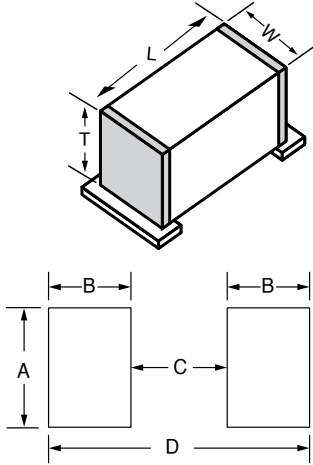

### Case Size L, S, and F

Case Size	A Min.	B Min.	C Min.	D Min.
<b>0402 (1005)</b>	.0275 (0.70)	.0354 (0.90)	.0157 (0.40)	.0866 (2.20)
<b>0603 (1608)</b>	.0393 (1.00)	.0433 (1.10)	.0236 (0.60)	.110 (2.80)
<b>0805 (2012)</b>	.0590 (1.50)	.0512 (1.30)	.0236 (0.60)	.1259 (3.20)

inches (mm)

## DESIGN KITS

Kit #	RoHS Compliant	Item #	Description	Cap. Value Range (pF)	Cap. Value (pF)	Tol. (pF)	Price
Kit 25T		DK0025T	600S Series Ultra-low ESR, High Q Microwave Capacitors 16 different values, 15 pcs. min. per value	0.1 to 2.0	0.1, 0.2, 0.3, 0.4, 0.5, 0.6, 0.7, 0.8, 0.9, 1.0, 1.1, 1.2, 1.5 ..... $\pm$ 0.1% 1.6, 1.8, 2.0 ..... $\pm$ 0.25%		\$100.00
Kit 26T		DK0026T	600S Series Ultra-low ESR, High Q Microwave Capacitors 16 different values, 15 pcs. min. per value	0.1 to 10	1.0, 1.2, 1.5, 1.8, 2.0, 2.2, 2.4, 2.7, 3.0, 3.3 ..... $\pm$ 0.1% 3.9, 4.7, 5.6, 6.8, 8.2 ..... $\pm$ 0.25% 10 ..... $\pm$ 5%		\$100.00
Kit 27T		DK0027T	600S Series Ultra-low ESR, High Q Microwave Capacitors 16 different values, 15 pcs. min. per value	10 to 100	10, 12, 15, 18, 20, 22, 24, 27, 30, 33, 39, 47 56, 68, 82, 100 ..... $\pm$ 5%		\$100.00

For Online Kit Orders, Catalog & Application Notes, Visit: [www.avx.com](http://www.avx.com)

# Mouser Electronics

Authorized Distributor

Click to View Pricing, Inventory, Delivery & Lifecycle Information:

## Kyocera AVX:

[600S2R2AW250XT](#) [600S5R1BT250XT](#) [600S101GW250XT](#) [600S330JT250XT](#) [600S200GT250XT](#)  
[600S0R6BT250XT](#) [600S390JW250XT](#) [600S101FT250XT](#) [600S240GT250XT](#) [600S4R3CT250XT](#) [600S0R9AT250XT](#)  
[600S2R0BW250XT](#) [600S7R5CT250XT](#) [600S180GT250XT](#) [600S3R3CT250XT](#) [600S270FW250XT](#)  
[600S5R6CW250XT](#) [600S620GT250XT](#) [600S6R2CT250XT](#) [600S0R3AW250XT](#) [600S1R6AT250XT](#)  
[600S430FW250XT](#) [600S0R9BW250XT](#) [600S910JT250XT](#) [600S2R7BW250XT](#) [600S560GT250XT](#) [600S101KT250XT](#)  
[600S1R0AW250XT](#) [600S470FT250XT](#) [600S360GT250XT](#) [600S100GT250XT](#) [600S9R1CT250XT](#)  
[600S0R7AT250XT](#) [600S0R5AW250XT](#) [600S6R8CT250XT](#) [600S270JT250XT](#) [600S0R8AT250XT](#) [600S820JT250XT](#)  
[600S1R8AT250XT](#) [600S220GW250XT](#) [600S3R0BT250XT](#) [600S300FW250XT](#) [600S0R1AT250XT](#)  
[600S680FW250XT](#) [600S0R2AT250XT](#) [600S220FT250XT](#) [600S470JW250XT](#) [600S2R2CT250XT](#) [600S0R4AW250XT](#)  
[600S120GW250XT](#) [600S1R0BT250XT](#) [600S3R6AT250XT](#) [600S470GT250XT](#) [600S3R9AT250XT](#)  
[600S1R2BW250XT](#) [600S220FW250XT](#) [600S1R1AT250XT](#) [600S1R3BT250XT](#) [600S4R3AT250XT](#)  
[600S4R7BW250XT](#) [600S0R1AW250XT](#) [600S620JT250XT](#) [600S6R8BT250XT](#) [600S0R4BT250XT](#) [600S180JT250XT](#)  
[600S9R1JT250XT](#) [600S100FT250XT](#) [600S9R1BT250XT](#) [600S1R8AW250XT](#) [600S5R1CT250XT](#)  
[600S750JT250XT](#) [600S270GT250XT](#) [600S2R4AT250XT](#) [600S2R7CT250XT](#) [600S110FT250XT](#) [600S5R6BT250XT](#)  
[600S680GT250XT](#) [600S110JT250XT](#) [600S3R3AW250XT](#) [600S6R2AT250XT](#) [600S390FT250XT](#) [600S100JT250XT](#)  
[600S2R0AT250XT](#) [600S0R2AW250XT](#) [600S360JT250XT](#) [600S8R2CW250XT](#) [600S220JT250XT](#) [600S1R8CT250XT](#)  
[600S510GT250XT](#) [600S6R8CW250XT](#) [600S0R5BT250XT](#) [600S2R7AT250XT](#) [600S150FW250XT](#)  
[600S3R9AW250XT](#) [600S100GW250XT](#) [600S270GW250XT](#) [600S1R5BT250XT](#) [600S0R7BT250XT](#)  
[600S300JT250XT](#) [600S4R7CT250XT](#)