

Contents

Pinouts	3	AC Timing Diagram	13
Pin Definitions	4	Ordering Information	14
Block Diagram Description	5	Ordering Code Definitions	14
Time Unit Definition	5	Package Diagram	15
Divide and Phase Select Matrix	6	Acronyms	16
Output Disable Description	8	Document Conventions	16
Lock Detect Output Description	8	Units of Measure	16
Factory Test Mode Description	8	Document History Page	17
Safe Operating Zone	8	Sales, Solutions, and Legal Information	18
Absolute Maximum Conditions	9	Worldwide Sales and Design Support	18
Operating Range	9	Products	18
Electrical Characteristics	9	PSoC® Solutions	18
Capacitance	10	Cypress Developer Community	18
Thermal Resistance	10	Technical Support	18
AC Test Loads and Waveforms	10		
Switching Characteristics	11		

Pinouts

Figure 1. 52-pin TQFP Pinout

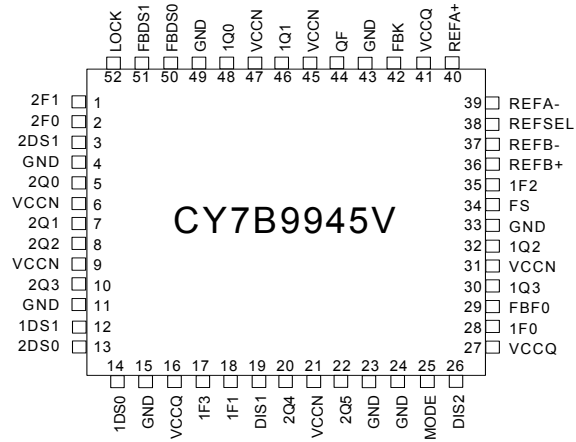

Pin Definitions

Pin	Name	I/O	Type	Description
34	FS	Input	Three level Input	Frequency Select. This input must be set according to the nominal frequency (f_{NOM}). See Table 1 .
40, 39, 36, 37	REFA+, REFA-, REFB+, REFB-	Input	LVTTL/ LVDIFF	Reference Inputs. These inputs can operate as differential PECL or single-ended TTL reference inputs to the PLL. When operating as a single-ended LVTTL input, the complementary input is left open.
38	REFSEL	Input	LVTTL	Reference Select Input. The REFSEL input controls the configuration of reference input. When LOW, it uses the REFA pair as the reference input. When HIGH, it uses the REFB pair as the reference input. This input has an internal pull down.
42	FBK	Input	LVTTL	Feedback Input Clock. The PLL operates such that the rising edges of the reference and feedback signals are aligned in phase and frequency. This pin provides the clock output QF feedback to the phase detector.
28, 18, 35, 17, 2, 1	1F[0:3], 2F[0:1]	Input	Three level Input	Output Phase Function Select. Each pair determines the phase of the respective bank of outputs. See Table 3 .
19, 26	DIS[1:2]	Input	LVTTL	Output Disable. Each input controls the state of the respective output bank. When HIGH, the output bank is disabled to HOLD-OFF or High-Z state; the disable state is determined by MODE. When LOW, outputs 1Q[0:3] and 2Q[0:5] are enabled. See Table 5 .
14, 12, 13, 3	[1:2]DS[0:1]	Input	Three level Input	Output Divider Function Select. Each pair determines the divider ratio of the respective bank of outputs. See Table 4 .
29	FBF0	Input	Three level Input	Feedback Output Phase Function Select. This input determines the phase of the QF output. See Table 3 .
50, 51	FBDS[0:1]	Input	Three level Input	Feedback Output Divider Function Select. This input determines the divider ratio of the QF output. See Table 4 .
48, 46, 32, 30, 5, 7, 8, 10, 20, 22	1Q[0:3], 2Q[0:5]	Output	LVTTL	Clock Outputs with Adjustable Phases and f_{NOM} Divide Ratios. The output frequencies and phases are determined by [1:2]DS[0:1], and 1F[0:3] and 2F[0:1], respectively. See Table 3 and Table 4 .
44	QF	Output	LVTTL	Feedback Clock Output. This output is connected to the FBK input. The output frequency and phase are determined by FBDS[0:1] and FBF0, respectively. See Table 3 and Table 4 .
52	LOCK	Output	LVTTL	PLL Lock Indicator. When HIGH, this output indicates that the internal PLL is locked to the reference signal. When LOW, it indicates that the PLL is attempting to acquire lock.
25	MODE	Input	Three level Input	This pin determines the clock outputs' disable state. When this input is HIGH, the clock outputs disables to high impedance state (High-Z). When this input is LOW, the clock outputs disables to HOLD-OFF mode. When in MID, the device enters factory test mode.
6, 9, 21, 31, 45, 47	VCCN		PWR	Power Supply for the Output Buffers
16, 27, 41	VCCQ		PWR	Power Supply for the Internal Circuitry
4, 11, 15, 23, 24, 33, 43, 49	GND		PWR	Device Ground

Block Diagram Description

The PLL adjusts the phase and the frequency of its output signal to minimize the delay between the reference (REFA/B+, REFA/B-) and the feedback (FB) input signals.

The CY7B9945V has a flexible REF input scheme. These inputs enable the use of either differential LVPECL or single ended LVTTTL inputs. To configure as single ended LVTTTL inputs, leave the complementary pin open (internally pulled to 1.5 V), then the other input pin is used as a LVTTTL input. The REF inputs are also tolerant to hot insertion.

The REF inputs are changed dynamically. When changing from one reference input to the other reference input of the same frequency, the PLL is optimized to ensure that the clock outputs period is not less than the calculated system budget ($t_{MIN} = t_{REF}$ (nominal reference period) – t_{CCJ} (cycle-cycle jitter) – t_{PDEV} (max. period deviation)) while reacquiring lock.

The FS control pin setting determines the nominal operational frequency range of the divide by one output (f_{NOM}) of the device. f_{NOM} is directly related to the VCO frequency. The FS setting for the device is shown in [Table 1](#). For CY7B9945V, the upper f_{NOM} range extends from 96 MHz to 200 MHz.

Table 1. Frequency Range Select

FS ^[1]	f_{NOM} (MHz)	
	Min	Max
LOW	24	52
MID	48	100
HIGH	96	200

Time Unit Definition

Selectable skew is in discrete increments of time unit (t_U). The value of a t_U is determined by the FS setting and the maximum nominal output frequency. The equation determines the t_U value as follows:

$$t_U = 1/(f_{NOM} * N).$$

N is a multiplication factor that is determined by the FS setting. f_{NOM} is nominal frequency of the device. N is defined in [Table 2](#).

Table 2. N Factor Determination

FS	CY7B9945V	
	N	f_{NOM} (MHz) at which $t_U = 1.0$ ns
LOW	32	31.25
MID	16	62.5
HIGH	8	125

Note

1. FB connected to an output selected for "Zero" skew (i.e., $FBF0 = MID$ or $XF[1:0] = MID$).

Divide and Phase Select Matrix

The Divide Select Matrix is comprised of three independent banks: two of clock outputs and one for feedback. The Phase Select Matrix, enables independent phase adjustments on 1Q[0:1], 1Q[2:3] and 2Q[0:5]. The frequency of 1Q[0:3] is controlled by 1DS[0:1] while the frequency of 2Q[0:5] is controlled by 2DS[0:1]. The phase of 1Q[0:1] is controlled by 1F[0:1], that of 1Q[2:3] is controlled by 1F[2:3] and that of 2Q[0:5] is controlled by 2F[0:1].

The high fanout feedback output buffer (QF) connects to the feedback input (FBK). This feedback output has one phase function select input (FBF0) and two divider function selects FBDS[0:1].

The phase capabilities that are chosen by the phase function select pins are shown in Table 3. The divide capabilities for each bank are shown in Table 4.

Table 3. Output Phase Select

Control Signal		Output Phase Function			
1F1	1F0	1Q[0:1]			
1F3	1F2		1Q[2:3]		
2F1	2F0			2Q[0:5]	
	FBF0				QF
LOW	LOW	-4t _U	-4t _U	-8t _U	-4t _U
LOW	MID	-3t _U	-3t _U	-7t _U	N/A
LOW	HIGH	-2t _U	-2t _U	-6t _U	N/A
MID	LOW	-1t _U	-1t _U	BK1Q[0:1] ^[2]	N/A
MID	MID	0t _U	0t _U	0t _U	0t _U
MID	HIGH	+1t _U	+1t _U	BK1Q[2:3] ^[2]	N/A
HIGH	LOW	+2t _U	+2t _U	+6t _U	N/A

Table 3. Output Phase Select (continued)

Control Signal		Output Phase Function			
HIGH	MID	+3t _U	+3t _U	+7t _U	N/A
HIGH	HIGH	+4t _U	+4t _U	+8t _U	+4t _U

Table 4. Output Divider Select

Control Signal		Output Divider Function		
[1:2]DS1 and FBDS1	[1:2]DS0 and FBDS0	Bank1	Bank2	Feedback
LOW	LOW	/ 1	/ 1	/ 1
LOW	MID	/ 2	/ 2	/ 2
LOW	HIGH	/ 3	/ 3	/ 3
MID	LOW	/ 4	/ 4	/ 4
MID	MID	/ 5	/ 5	/ 5
MID	HIGH	/ 6	/ 6	/ 6
HIGH	LOW	/ 8	/ 8	/ 8
HIGH	MID	/ 10	/ 10	/ 10
HIGH	HIGH	/ 12	/ 12	/ 12

Figure 2 on page 7 shows the timing relationship of programmable skew outputs. All times are measured with respect to REF with the output used for feedback programmed with 0t_U skew. The PLL naturally aligns the rising edge of the FB input and REF input. If the output used for feedback is programmed to another skew position, then the whole t_U matrix shifts with respect to REF. For example, if the output used for feedback is programmed to shift -4t_U, then the whole matrix is shifted forward in time by 4t_U. Thus an output programmed with 4t_U of skew gets effectively be skewed 8t_U with respect to REF.

Note

- The level set on FS is determined by the "nominal" operating frequency (f_{NOM}) of the V_{CO} and Phase Generator. f_{NOM} always appears on an output when the output is operating in the undivided mode. The REF and FB are at f_{NOM} when the output connected to FB is undivided.

Figure 2. Typical Outputs with FB Connected to a Zero-Skew Output [3]

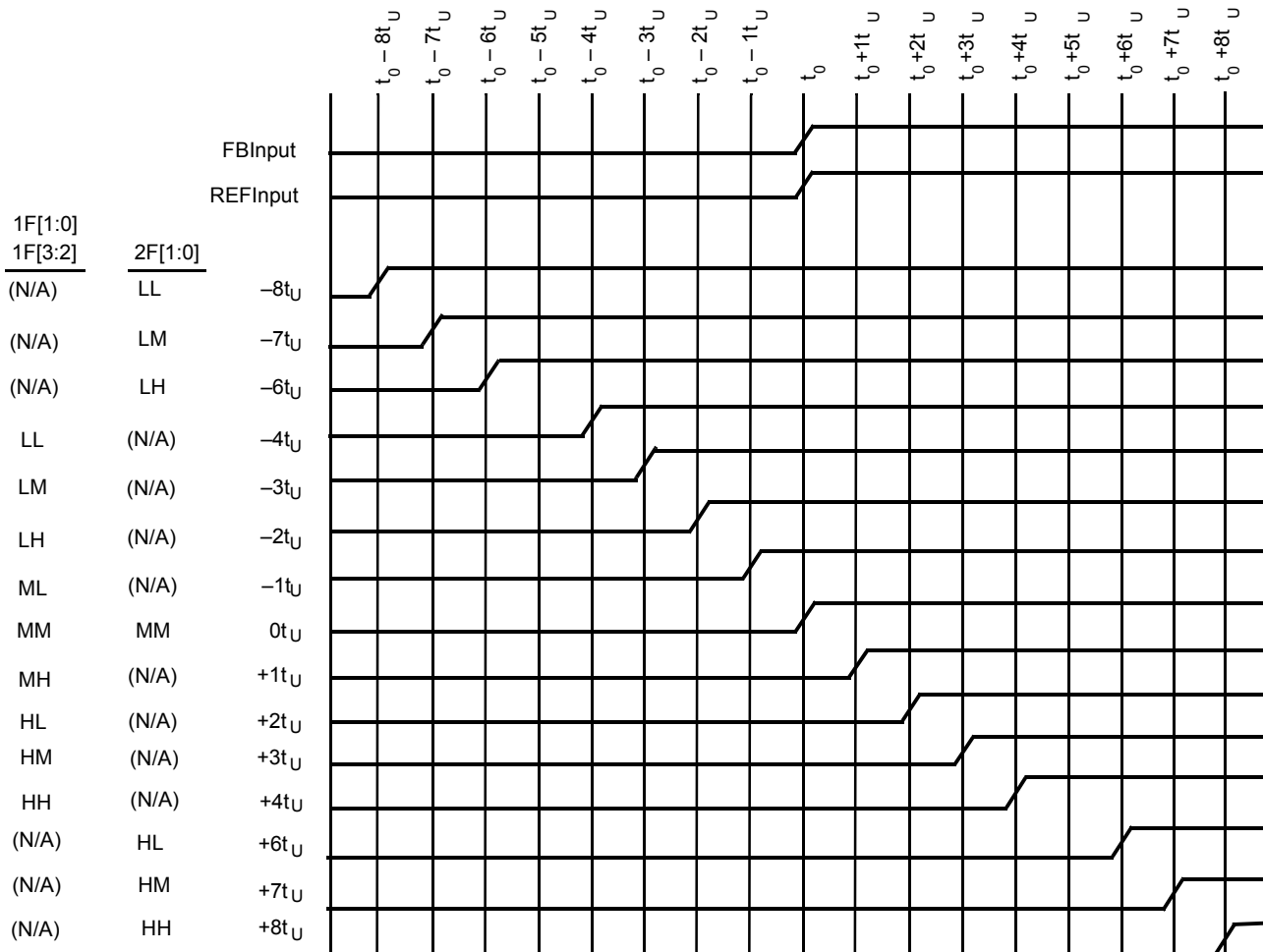

Note

3. BK1Q denotes following the skew setting of indicated Bank1 outputs.

Output Disable Description

The output of each output bank can be independently put into a HOLD OFF or high impedance state. The combination of the MODE and DIS[1:2] inputs determines the clock outputs' state for each bank. When the DIS[1:2] is LOW, the outputs of the corresponding banks are enabled. When DIS[1:2] is HIGH, the outputs for that bank are disabled to a high impedance (HI-Z) or HOLD OFF state. Table 5 defines the disabled outputs functions.

The HOLD OFF state is a power saving feature. An output bank is disabled to the HOLD OFF state in a maximum of six output clock cycles from the time the disable input is HIGH. When disabled to the HOLD OFF state, outputs are driven to a logic LOW state on their falling edges. This makes certain that the output clocks are stopped without a glitch. When a bank of outputs is disabled to HI-Z state, the respective bank of outputs go High-Z immediately.

Table 5. DIS[1:2] Functionality

MODE	DIS[1:2]	1Q[0:3], 2Q[0:5]
HIGH/LOW	LOW	ENABLED
HIGH	HIGH	HI-Z
LOW	HIGH	HOLD-OFF
MID	X	FACTORY TEST

Lock Detect Output Description

The LOCK detect output indicates the lock condition of the integrated PLL. Lock detection is accomplished by comparing the phase difference between the reference and feedback inputs. Phase error is declared when the phase difference between the two inputs is greater than the specified device propagation delay limit t_{PD} .

When in the locked state, after four or more consecutive feedback clock cycles with phase errors, the LOCK output is forced LOW to indicate out-of-lock state.

When in the out-of-lock state, 32 consecutive phase errorless feedback clock cycles are required to enable the LOCK output to indicate lock condition (LOCK = HIGH).

If the feedback clock is removed after LOCK has gone HIGH, a "Watchdog" circuit is implemented to indicate the out-of-lock condition after a time-out period by deasserting LOCK LOW. This time out period is based upon a divided down reference clock.

This assumes that there is activity on the selected REF input. If there is no activity on the selected REF input then the LOCK detect pin does not accurately reflect the state of the internal PLL.

Factory Test Mode Description

The device enters factory test mode when the MODE is driven to MID. In factory test mode, the device operates with its internal

PLL disconnected; input level supplied to the reference input is used in place of the PLL output. In TEST mode the FB input is tied LOW. All functions of the device remain operational in factory test mode except the internal PLL and output bank disables. The MODE input is designed as a static input. Dynamically toggling this input from LOW to HIGH temporarily causes the device to go into factory test mode (when passing through the MID state).

When in the test mode, the device is reset to a deterministic state by driving the DIS2 input HIGH. Doing so disables all outputs and, after the selected reference clock pin has five positive transitions, all internal finite state machines (FSM) are set at a deterministic state. The states depend on the configurations of the divide, skew and frequency selection. All clock outputs stay in High-Z mode and all FSMs stay in the deterministic state until DIS2 is deasserted. This causes the device to reenter factory test mode.

Safe Operating Zone

Figure 3 shows the operating condition of the device not exceeding its allowable maximum junction temperature of 150°C. Figure 3 shows the maximum number of outputs that can operate at 185 MHz (with 25 pF load and no air flow) or 200 MHz (with 10-pF load and no air flow) at various ambient temperatures. At the limit line, all other outputs are configured to divide-by-two (i.e., operating at 92.5 MHz) or lower frequencies. The device operates below maximum allowable junction temperature of 150°C when its configuration (with the specified constraints) falls within the shaded region (safe operating zone). Figure 3 shows that at 85°C, the maximum number of outputs that can operate at 200 MHz is 6.

Figure 3. Typical Safe Operating Zone

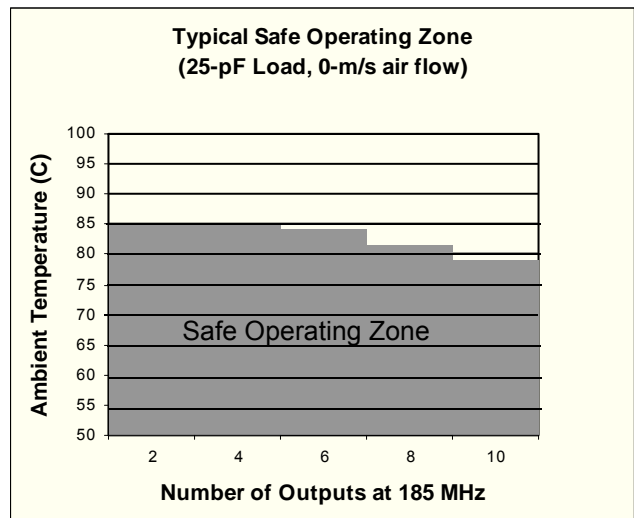

Absolute Maximum Conditions

Exceeding maximum ratings may shorten the useful life of the device. User guidelines are not tested.

Storage Temperature	-40 °C to +125 °C
Ambient Temperature with Power Applied	-40 °C to +125 °C
Supply Voltage to Ground Potential	-0.5 V to +4.6 V
DC Input Voltage	-0.3 V to $V_{CC} + 0.5$ V

Output Current into Outputs (LOW)	40 mA
Static Discharge Voltage (MIL-STD-883, Method 3015)	> 1100 V
Latch-up Current	> ± 200 mA

Operating Range

Range	Ambient Temperature	V_{CC}
Commercial	0 °C to +70 °C	3.3 V ±10%
Industrial	-40 °C to +85 °C	3.3 V ±10%

Electrical Characteristics

Over the Operating Range

Description		Test Conditions	Min	Max	Unit
LVTTL HIGH Voltage	(QF, 1Q[0:3], 2Q[0:5])	$V_{CC} = \text{Min}, I_{OH} = -30 \text{ mA}$	2.4	-	V
	LOCK	$I_{OH} = -2 \text{ mA}, V_{CC} = \text{Min}$	2.4	-	V
LVTTL LOW Voltage	(QF, 1Q[0:3], 2Q[0:5])	$V_{CC} = \text{Min}, I_{OL} = 30 \text{ mA}$	-	0.5	V
	LOCK	$I_{OL} = 2 \text{ mA}, V_{CC} = \text{Min}$	-	0.5	V
High impedance State Leakage Current			-100	100	µA
LVTTL Input HIGH		$\text{Min} \leq V_{CC} \leq \text{Max}$	2.0	$V_{CC} + 0.3$	V
LVTTL Input LOW		$\text{Min.} \leq V_{CC} \leq \text{Max.}$	-0.3	0.8	V
LVTTL $V_{IN} > V_{CC}$		$V_{CC} = \text{GND}, V_{IN} = 3.63 \text{ V}$	-	100	µA
LVTTL Input HIGH Current		$V_{CC} = \text{Max}, V_{IN} = V_{CC}$	-	500	µA
LVTTL Input LOW Current		$V_{CC} = \text{Max}, V_{IN} = \text{GND}$	-500	-	µA
Three level Input HIGH ^[4]		$\text{Min} \leq V_{CC} \leq \text{Max}$	$0.87 \times V_{CC}$	-	V
Three level Input MID ^[4]		$\text{Min} \leq V_{CC} \leq \text{Max}$	$0.47 \times V_{CC}$	$0.53 \times V_{CC}$	V
Three level Input LOW ^[4]		$\text{Min} \leq V_{CC} \leq \text{Max}$	-	$0.13 \times V_{CC}$	V
Three level Input HIGH Current	FS[0:2],IF[0:3],FBDS[0:1]	$V_{IN} = V_{CC}$	-	200	µA
	2F[0:1],[1:2]DS[0:1],FBFO		-	400	µA
Three level Input MID Current	FS[0:2],IF[0:3],FBDS[0:1]	$V_{IN} = V_{CC}/2$	-50	50	µA
	2F[0:1],[1:2]DS[0:1],FBFO		-100	100	µA
Three level Input LOW Current	FS[0:2],IF[0:3],FBDS[0:1]	$V_{IN} = \text{GND}$	-200	-	µA
	2F[0:1],[1:2]DS[0:1],FBFO		-400	-	µA
Input Differential Voltage			400	V_{CC}	mV
Highest Input HIGH Voltage			1.0	V_{CC}	V
Lowest Input LOW Voltage			GND	$V_{CC} - 0.4$	V
Common Mode Range (Crossing Voltage)			0.8	$V_{CC} - 0.2$	V
Internal Operating Current	CY7B9945V	$V_{CC} = \text{Max}, f_{\text{MAX}}^{\text{[5]}}$	-	250	mA
Output Current Dissipation/Pair ^[4]	CY7B9945V	$V_{CC} = \text{Max}, C_{\text{LOAD}} = 25 \text{ pF}, R_{\text{LOAD}} = 50 \Omega \text{ at } V_{CC}/2, f_{\text{MAX}}$	-	40	mA

Notes

- These inputs are normally wired to V_{CC} , GND, or left unconnected (actual threshold voltages vary as a percentage of V_{CC}). Internal termination resistors hold the unconnected inputs at $V_{CC}/2$. If these inputs are switched, the function and timing of the outputs may glitch and the PLL may require an additional t_{LOCK} time before all data sheet limits are achieved.
- This is for non-three level inputs.

Capacitance

Parameter	Description	Test Conditions	Min	Max	Unit
C _{IN}	Input Capacitance	T _A = 25 °C, f = 1 MHz, V _{CC} = 3.3 V	–	5	pF

Thermal Resistance

Parameter [6]	Description	Test Conditions	52-pin TQFP	Unit
θ _{JA}	Thermal resistance (junction to ambient)	Test conditions follow standard test methods and procedures for measuring thermal impedance, in accordance with EIA/JESD51.	55	°C/W
θ _{JC}	Thermal resistance (junction to case)		16	°C/W

AC Test Loads and Waveforms

Figure 4. AC Test Loads and Waveforms [7]

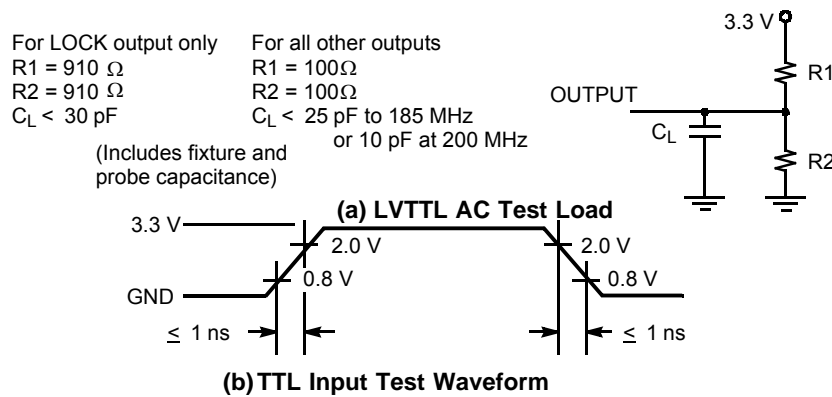

Notes

- 6. These parameters are guaranteed by design and are not tested.
- 7. Assumes 25 pF Maximum Load Capacitance up to 185 MHz. At 200 MHz the maximum load is 10 pF.

Switching Characteristics

Over the Operating Range [8, 9, 10, 11, 12]

Parameter	Description	CY7B9945V-2		Unit
		Min	Max	
f_{in}	Clock Input Frequency	24	200	MHz
f_{out}	Clock Output Frequency	24	200	MHz
t_{SKEWPR}	Matched Pair Skew [13, 14], 1Q[0:1], 1Q[2:3], 2Q[0:1], 2Q[2:3], 2Q[4:5]	–	200	ps
$t_{SKEWBNK}$	Intrabank Skew [13, 14]	–	250	ps
t_{SKEW0}	Output-Output Skew (same frequency and phase, rise to rise, fall to fall) [13, 14]	–	250	ps
t_{SKEW1}	Output-Output Skew (same frequency and phase, other banks at different frequency, rise to rise, fall to fall) [13, 14]	–	250	ps
t_{SKEW2}	Output-Output Skew (all output configurations outside of t_{SKEW0} and t_{SKEW1}) [12, 15]	–	500	ps
t_{CCJ1-3}	Cycle-to-Cycle Jitter (divide by 1 output frequency, FB = divide by 1, 2, 3)	–	150	ps Peak-Peak
$t_{CCJ4-12}$	Cycle-to-Cycle Jitter (divide by 1 output frequency, FB = divide by 4, 5, 6, 8, 10, 12)	–	100	ps Peak-Peak
t_{PD}	Propagation Delay, REF to FB Rise	–250	250	ps
TTB	Total Timing Budget window (same frequency and phase) [16, 17]	–	500	ps
$t_{PDDELTA}$	Propagation Delay difference between two devices [18]	–	200	ps
t_{REFpwh}	REF input (Pulse Width HIGH) [8]	2.0	–	ns
t_{REFpwl}	REF input (Pulse Width LOW) [8]	2.0	–	ns
t_r/t_f	Output Rise/Fall Time [21]	0.15	2.0	ns
t_{LOCK}	PLL Lock Time From Power Up	–	10	ms
$t_{RELOCK1}$	PLL Relock Time (from same frequency, different phase) with Stable Power Supply	–	500	μs
$t_{RELOCK2}$	PLL Re-lock Time (from different frequency, different phase) with Stable Power Supply [20]	–	1000	μs

Notes

8. This is for non-three level inputs.
9. Both outputs of pair must be terminated, even if only one is being used.
10. Each package must be properly decoupled.
11. AC parameters are measured at 1.5 V, unless otherwise indicated.
12. Test Load $C_L = 25$ pF, terminated to $V_{CC}/2$ with 50Ω up to 185 MHz and 10 pF load to 200 MHz.
13. Tested initially and after any design or process changes that affect these parameters.
14. TTB is the window between the earliest and the latest output clocks with respect to the input reference clock across variations in output frequency, supply voltage, operating temperature, input clock edge rate, and process. The measurements are taken with the AC test load specified and include output-output skew, cycle-cycle jitter, and dynamic phase error. TTB is equal to or smaller than the maximum specified value at a given output frequency.
15. SKEW is defined as the time between the earliest and the latest output transition among all outputs for which the same phase delay has been selected when all outputs are loaded with 25 pF and properly terminated up to 185 MHz. At 200 MHz the max load is 10 pF.
16. Guaranteed by statistical correlation. Tested initially and after any design or process changes that affects these parameters.
17. Rise and fall times are measured between 2.0 V and 0.8 V.
18. f_{NOM} must be within the frequency range defined by the same FS state.
19. t_{pWH} is measured at 2.0 V. t_{pWL} is measured at 0.8 V.
20. f_{NOM} must be within the frequency range defined by the same FS state.

Switching Characteristics (continued)

Over the Operating Range [8, 9, 10, 11, 12]

Parameter	Description	CY7B9945V-2		Unit
		Min	Max	
t_{ODCV}	Output duty cycle deviation from 50% ^[21]	-1.0	1.0	ns
t_{PWH}	Output HIGH time deviation from 50% ^[22]	-	1.5	ns
t_{PWL}	Output LOW time deviation from 50% ^[22]	-	2.0	ns
t_{PDEV}	Period deviation when changing from reference to reference ^[23]	-	0.025	UI
t_{OAZ}	DIS[1:2] HIGH to output high-impedance from ACTIVE ^[24, 25]	1.0	10	ns
t_{OZA}	DIS[1:2] LOW to output ACTIVE from output is high impedance ^[25]	0.5	14	ns

Notes

21. SKEW is defined as the time between the earliest and the latest output transition among all outputs for which the same phase delay has been selected when all outputs are loaded with 25 pF and properly terminated up to 185 MHz. At 200 MHz the max load is 10 pF.
22. Measured at 0.5 V deviation from starting voltage.
23. For t_{OZA} minimum, $C_L = 0$ pF. For t_{OZA} maximum, $C_L = 25$ pF to 185 MHz or 10 pF to 200 MHz.
24. Tested initially and after any design or process changes that affect these parameters.
25. These figures are for illustration purposes only. The actual ATE loads may vary.

AC Timing Diagram

Figure 5. AC Timing Diagram

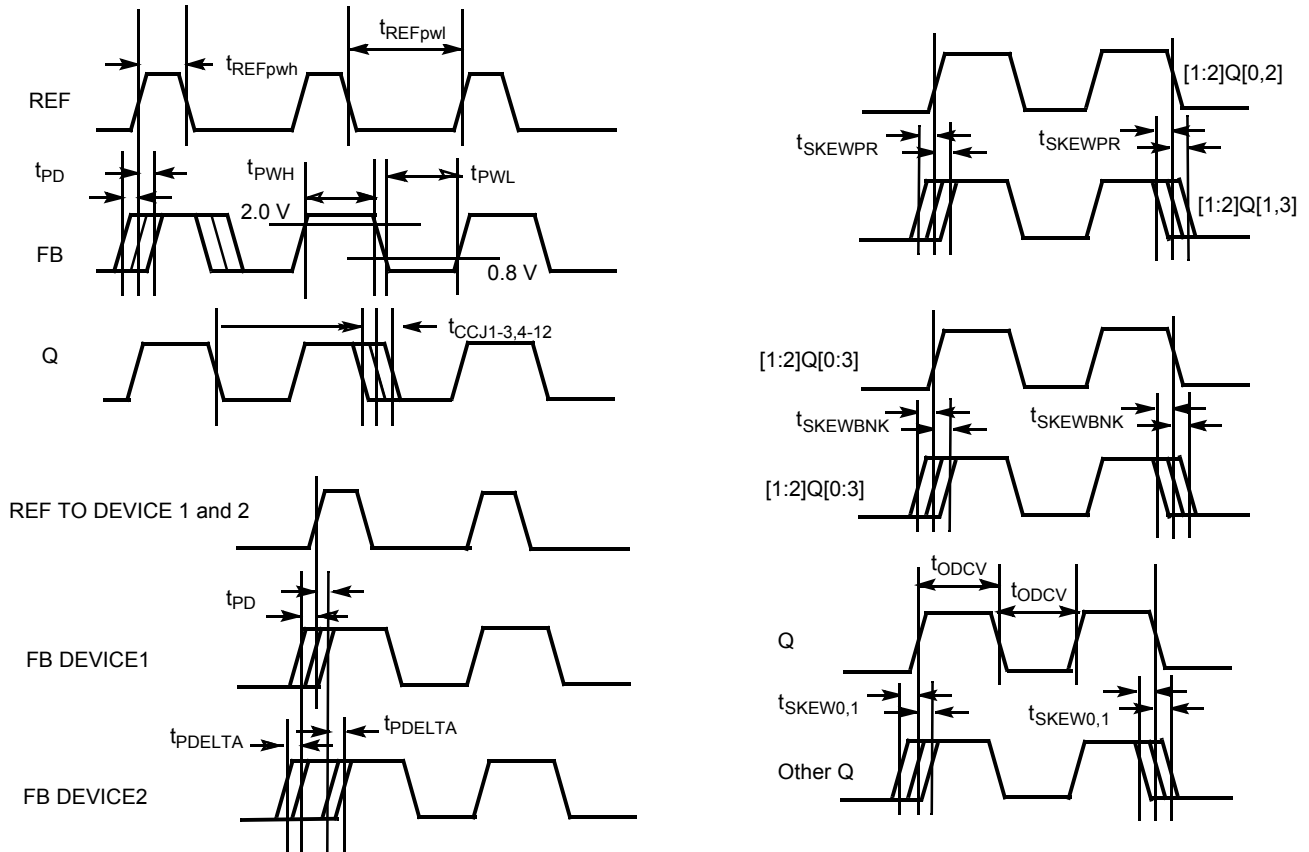

Ordering Information

Propagation Delay (ps)	Max. Speed (MHz)	Ordering Code	Package Name	Package Type	Operating Range
Pb-free					
250	200	CY7B9945V-2AXC	AZ52	52-pin TQFP	Commercial
	200	CY7B9945V-2AXCT	AZ52	52-pin TQFP – Tape and Reel	Commercial
250	200	CY7B9945V-2AXI	AZ52	52-pin TQFP	Industrial
	200	CY7B9945V-2AXIT	AZ52	52-pin TQFP – Tape and Reel	Industrial

Ordering Code Definitions

CY XXXXXX V - 2 A X C I

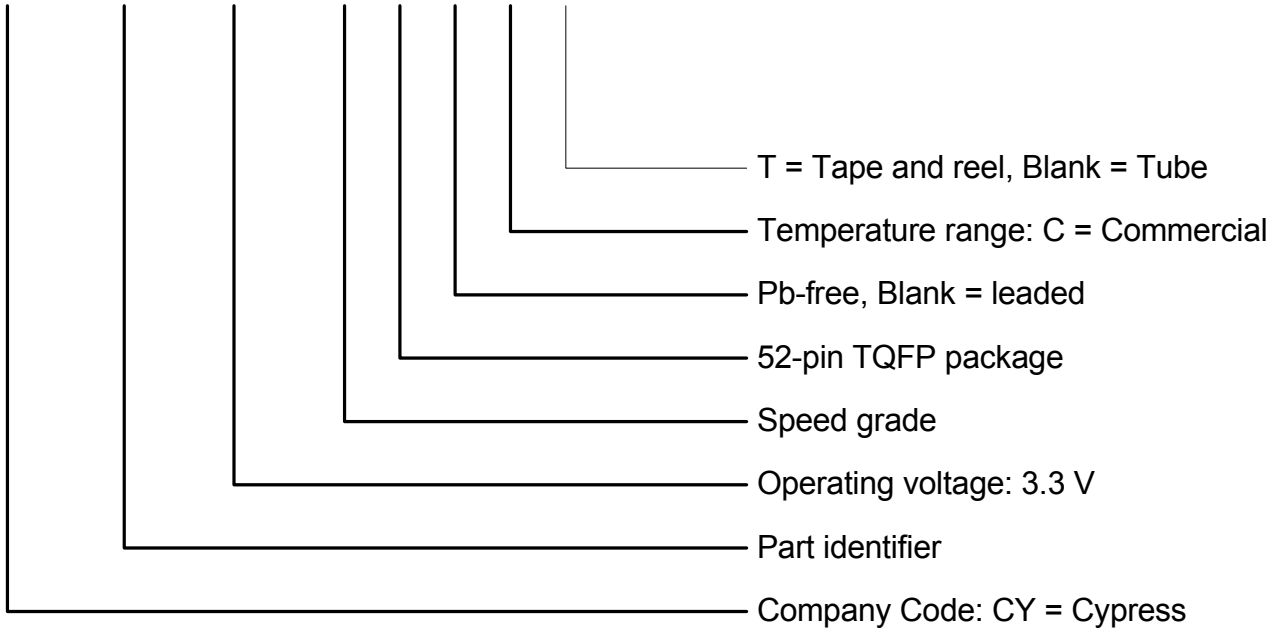

Package Diagram

Figure 6. 52-pin TQFP (10 × 10 × 1.4 mm) Package Outline, 51-85131

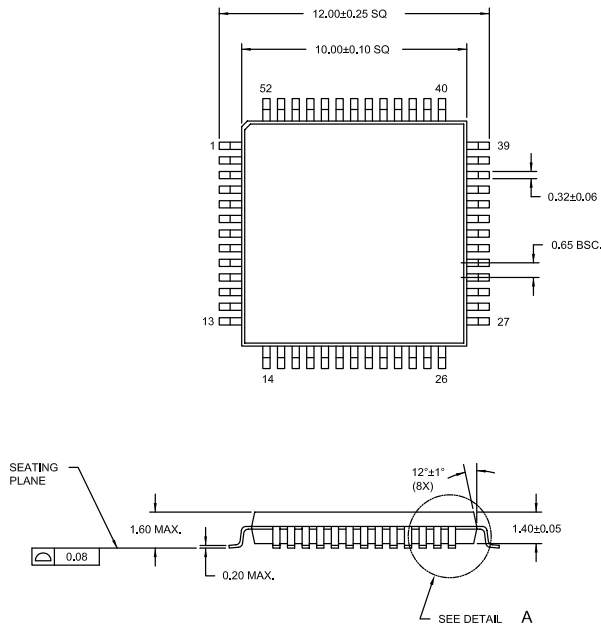

DIMENSIONS ARE IN MILLIMETERS

Package Weight - Refer to PMDD spec.

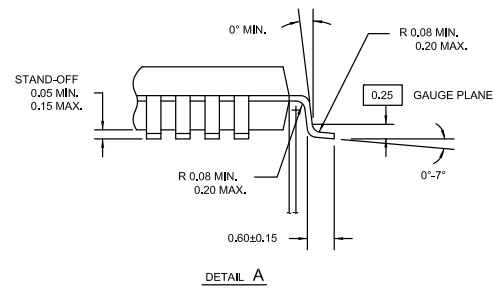

51-85131 *C

Acronyms

Table 6. Acronyms Used in this Document

Acronym	Description
FSM	Finite State Machine
LVPECL	Low-Voltage Positive Emitter Coupled Logic
LVTTTL	Low-Voltage Transistor-Transistor Logic
OE	Output Enable
RMS	Root Mean Square
PLL	Phase Locked Loop
TQFP	Thin Quad Flat Pack
VCO	Voltage Controlled Oscillator

Document Conventions

Units of Measure

Table 7. Units of Measure

Symbol	Unit of Measure	Symbol	Unit of Measure
°C	degrees Celsius	μVrms	microvolts root-mean-square
dB	decibel	μW	microwatt
dBc/Hz	decibels relative to the carrier per Hertz	mA	milliampere
fC	femtoCoulomb	mm	millimeter
fF	femtofarad	ms	millisecond
Hz	hertz	mV	millivolt
KB	1024 bytes	nA	nanoampere
Kbit	1024 bits	ns	nanosecond
kHz	kilohertz	nV	nanovolt
kΩ	kilohm	Ω	ohm
MHz	megahertz	pA	picoampere
MΩ	megaohm	pF	picofarad
μA	microampere	pp	peak-to-peak
μF	microfarad	ppm	parts per million
μH	microhenry	ps	picosecond
μs	microsecond	sps	samples per second
μV	microvolt	σ	sigma: one standard deviation

Document History Page

Document Title: CY7B9945V RoboClock®, High-Speed Multi-Phase PLL Clock Buffer				
Document Number: 38-07336				
Revision	ECN	Orig. of Change	Submission Date	Description of Change
**	111747	CTK	03/04/02	New data sheet
*A	116572	HWT	09/05/02	Added TTB Features
*B	119078	HWT	10/16/02	Corrected the following items in the Electrical Characteristics table: I_{III} , I_{IIH} , I_{IIM} specifications from: three level input pins excluding FBFO to FS[0:2], IF[0:3], FBDS[0:1] and FBFO to 2F[0:1], [1:2]DS[0:1], FBFO Common Mode Range (V_{COM}) from V_{CC} to $V_{CC}-0.2$ Corrected typo TQFP to LQFP in Features
*C	124645	RGL	03/20/03	Corrected typo LQFP to TQFP in Features
*D	128464	RGL	07/25/03	Added clock input frequency (f_{in}) specifications in the switching characteristics table.
*E	272075	RGL	See ECN	Minor Change: Fixed the Typical Outputs (Fig. 1) diagram
*F	1187144	KVM	See ECN	Updated Ordering Information table, primarily to add Pb-free devices
*G	2761988	CXQ	09/10/09	Changed instances of "50W" to "50Ω" on page 1. Changed "Pb" to "lead" in Ordering Information package type section. Added "Not recommended for new designs" note to all Pb packages.
*H	2891379	KVM	03/12/2010	Added Table of Contents Updated Ordering Information table Updated Package Diagram Updated Sales, Solutions, and Legal Information
*I	2905846	KVM	04/06/2010	Removed inactive part from Ordering Information table.
*J	3196237	BASH	03/15/11	Added Ordering Code Definitions . Added Acronyms and Units of Measure . Updated to new template.
*K	4323331	CINM	03/27/2014	Updated Package Diagram : spec 51-85131 – Changed revision from *A to *C. Updated to new template. Completing Sunset Review.
*L	4570146	CINM	11/14/2014	Updated Functional Description : Added "For a complete list of related documentation, click here ." at the end.
*M	5257087	PSR	05/03/2016	Changed status from Preliminary to Final. Added Thermal Resistance . Updated to new template.
*N	5687997	XHT	04/07/2017	Updated template. No content update. Completing sunset review.
*O	5773768	PSR	06/19/2017	Removed CY7B9945V-5 parameters in Switching Characteristics .

Sales, Solutions, and Legal Information

Worldwide Sales and Design Support

Cypress maintains a worldwide network of offices, solution centers, manufacturer's representatives, and distributors. To find the office closest to you, visit us at [Cypress Locations](#).

Products

ARM® Cortex® Microcontrollers	cypress.com/arm
Automotive	cypress.com/automotive
Clocks & Buffers	cypress.com/clocks
Interface	cypress.com/interface
Internet of Things	cypress.com/iot
Memory	cypress.com/memory
Microcontrollers	cypress.com/mcu
PSoC	cypress.com/psoc
Power Management ICs	cypress.com/pmic
Touch Sensing	cypress.com/touch
USB Controllers	cypress.com/usb
Wireless Connectivity	cypress.com/wireless

PSoC® Solutions

[PSoC 1](#) | [PSoC 3](#) | [PSoC 4](#) | [PSoC 5LP](#) | [PSoC 6](#)

Cypress Developer Community

[Forums](#) | [WICED IOT Forums](#) | [Projects](#) | [Video](#) | [Blogs](#) | [Training](#) | [Components](#)

Technical Support

cypress.com/support

Clock Tree Services

cypress.com/cts

© Cypress Semiconductor Corporation, 2002-2017. This document is the property of Cypress Semiconductor Corporation and its subsidiaries, including Spansion LLC ("Cypress"). This document, including any software or firmware included or referenced in this document ("Software"), is owned by Cypress under the intellectual property laws and treaties of the United States and other countries worldwide. Cypress reserves all rights under such laws and treaties and does not, except as specifically stated in this paragraph, grant any license under its patents, copyrights, trademarks, or other intellectual property rights. If the Software is not accompanied by a license agreement and you do not otherwise have a written agreement with Cypress governing the use of the Software, then Cypress hereby grants you a personal, non-exclusive, nontransferable license (without the right to sublicense) (1) under its copyright rights in the Software (a) for Software provided in source code form, to modify and reproduce the Software solely for use with Cypress hardware products, only internally within your organization, and (b) to distribute the Software in binary code form externally to end users (either directly or indirectly through resellers and distributors), solely for use on Cypress hardware product units, and (2) under those claims of Cypress's patents that are infringed by the Software (as provided by Cypress, unmodified) to make, use, distribute, and import the Software solely for use with Cypress hardware products. Any other use, reproduction, modification, translation, or compilation of the Software is prohibited.

TO THE EXTENT PERMITTED BY APPLICABLE LAW, CYPRESS MAKES NO WARRANTY OF ANY KIND, EXPRESS OR IMPLIED, WITH REGARD TO THIS DOCUMENT OR ANY SOFTWARE OR ACCOMPANYING HARDWARE, INCLUDING, BUT NOT LIMITED TO, THE IMPLIED WARRANTIES OF MERCHANTABILITY AND FITNESS FOR A PARTICULAR PURPOSE. To the extent permitted by applicable law, Cypress reserves the right to make changes to this document without further notice. Cypress does not assume any liability arising out of the application or use of any product or circuit described in this document. Any information provided in this document, including any sample design information or programming code, is provided only for reference purposes. It is the responsibility of the user of this document to properly design, program, and test the functionality and safety of any application made of this information and any resulting product. Cypress products are not designed, intended, or authorized for use as critical components in systems designed or intended for the operation of weapons, weapons systems, nuclear installations, life-support devices or systems, other medical devices or systems (including resuscitation equipment and surgical implants), pollution control or hazardous substances management, or other uses where the failure of the device or system could cause personal injury, death, or property damage ("Unintended Uses"). A critical component is any component of a device or system whose failure to perform can be reasonably expected to cause the failure of the device or system, or to affect its safety or effectiveness. Cypress is not liable, in whole or in part, and you shall and hereby do release Cypress from any claim, damage, or other liability arising from or related to all Unintended Uses of Cypress products. You shall indemnify and hold Cypress harmless from and against all claims, costs, damages, and other liabilities, including claims for personal injury or death, arising from or related to any Unintended Uses of Cypress products.

Cypress, the Cypress logo, Spansion, the Spansion logo, and combinations thereof, WICED, PSoC, CapSense, EZ-USB, F-RAM, and Traveo are trademarks or registered trademarks of Cypress in the United States and other countries. For a more complete list of Cypress trademarks, visit cypress.com. Other names and brands may be claimed as property of their respective owners.

Mouser Electronics

Authorized Distributor

Click to View Pricing, Inventory, Delivery & Lifecycle Information:

[Cypress Semiconductor:](#)

[CY7B9945V-2AXC](#) [CY7B9945V-2AXI](#)