

Ordering Information

ACPL-2x4-xxxx is UL Recognized with 3750 V_{RMS} for 1 minute per UL1577 and Canadian Component Acceptance Notice #5.

Part Number	RoHS Compliant Option	Package	Number of Channels	Surface Mount	Tape and Reel	IEC/EN DIN EN 60747-5-5	Quantity
	Rank 0, 20% < C R < 400%, I _F = ±1 mA, V _{CE} = 5V						
ACPL-224	-500E	SO-8	Dual	X	X		2000 pcs per reel
	-560E	SO-8	Dual	X	X	X	2000 pcs per reel
ACPL-244	-500E	SO-16	Quad	X	X		2000 pcs per reel
	-560E	SO-16	Quad	X	X	X	2000 pcs per reel

To order, choose a part number from the part number column and combine with the desired option from the option column to form an order entry.

Example 1:

ACPL-224-560E to order product of Dual Channel SO-8 Surface Mount package in Tape and Reel with IEC/EN/DIN EN 60747-5-5 Safety Approval, 20% < CTR < 400% and RoHS compliant.

Example 2:

ACPL-244-500E to order product of Quad Channel SO-16 Surface Mount package in Tape and Reel packaging with 20% < CTR < 400% and RoHS compliant.

Option data sheets are available. Contact your Broadcom sales representative or authorized distributor for information.

Package Outline Drawings

ACPL-224 PACKAGE OUTLINE

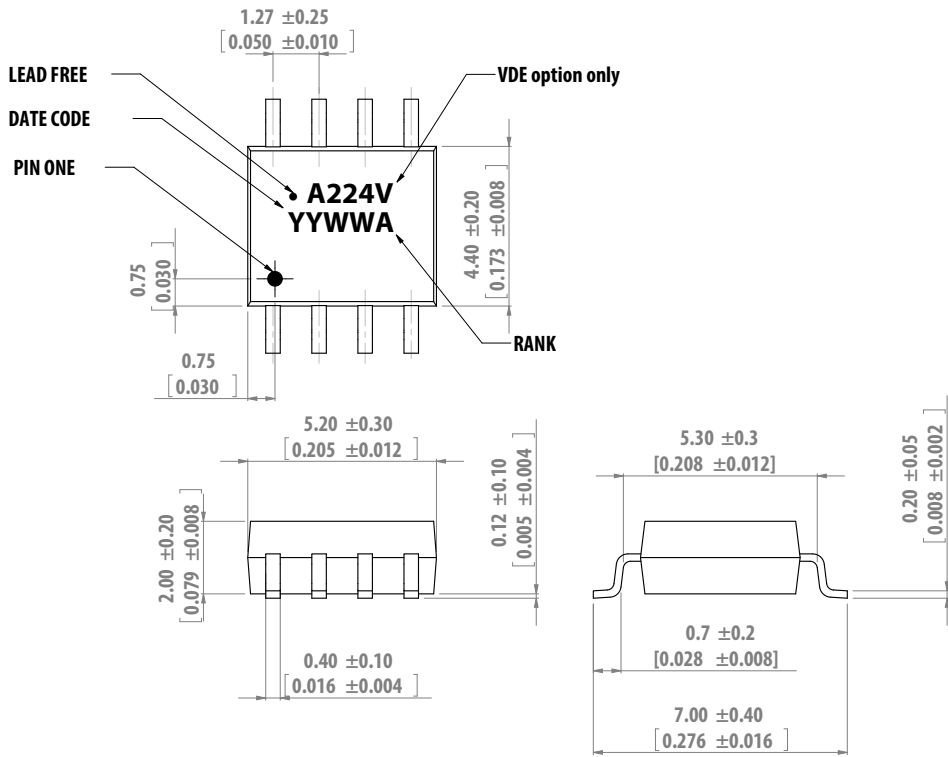

DIMENSIONS IN MILLIMETERS [INCHES]

ACPL-244 PACKAGE OUTLINE

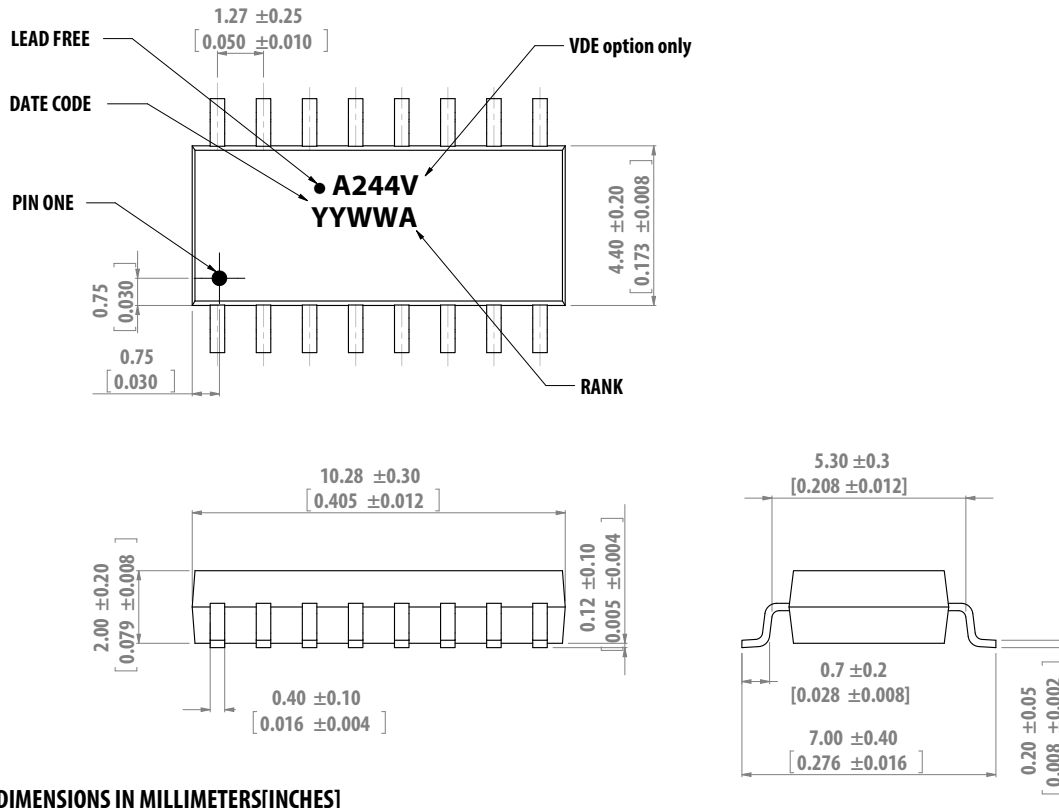

DIMENSIONS IN MILLIMETERS[INCHES]

Solder Reflow Temperature Profile

Recommended reflow condition as per JEDEC Standard, J-STD-020 (latest revision). Non-Halide Flux should be used.

Absolute Maximum Ratings

Parameter	Symbol	ACPL-224	ACPL-244	Unit	Note
Storage Temperature	T_S	-55~125		°C	
Operating Temperature	T_A	-55~110		°C	
Average Forward Current	$I_{F(AVG)}$	±50		mA	
Pulse Forward Current	I_{FSM}	±1		A	
Reverse Voltage	V_R	6		V	
LED Power Dissipation (1 channel)	P_I	65		mW	
Collector Current	I_C	50		mA	
Collector-Emitter Voltage	V_{CEO}	80		V	
Emitter-Collector Voltage	V_{ECO}	7		V	
Isolation Voltage (AC for 1 minute, R.H. 40%~60%)	V_{ISO}	3750		V_{RMS}	1 minute
Collector Power Dissipation (1 channel)	P_C	150	100	mW	
Total Power Dissipation	P_{TOT}	200	170	mW	
Lead Solder Temperature	260°C for 10 seconds				

Electrical Specifications

Over recommended ambient temperature at 25°C unless otherwise specified.

Parameter	Symbol	Min.	Typ.	Max.	Unit	Test Conditions	Note
Forward Voltage	V_F	—	1.2	1.4	V	$I_F = \pm 20$ mA	Figure 6
Reverse Current	I_R	—	—	10	μ A	$V_R = 5$ V	
Terminal Capacitance	C_t	—	30	—	pF	$V = 0$, $f = 1$ MHz	
Collector Dark Current	I_{CEO}	—	—	100	nA	$V_{CE} = 48$ V, $I_F = 0$ mA	Figure 12
Collector-Emitter Breakdown Voltage	BV_{CEO}	80	—	—	V	$I_C = 0.5$ mA, $I_F = 0$ mA	
Emitter-Collector Breakdown Voltage	BV_{ECO}	7	—	—	V	$I_E = 100$ μ A, $I_F = 0$ mA	
Current Transfer Ratio	CTR	20	—	400	%	$I_F = \pm 1$ mA, $V_{CE} = 5$ V	$CTR = (I_C / I_F) \times 100\%$
Saturated CTR	CTR(sat)	—	60	—	%	$I_F = \pm 1$ mA, $V_{CE} = 0.4$ V	
Collector-Emitter Saturation Voltage	$V_{CE(sat)}$	—	—	0.4	V	$I_F = \pm 8$ mA, $I_C = 2.4$ mA	Figure 14
Isolation Resistance	R_{iso}	5×10^{10}	1×10^{11}	—	Ω	DC500V, R.H. 40%~60%	
Floating Capacitance	C_F	—	0.6	1	pF	$V = 0$, $f = 1$ MHz	
Cut-off Frequency (-3dB)	F_C	—	80	—	kHz	$V_{CC} = 5$ V, $I_C = 2$ mA, $R_L = 100\Omega$	Figure 2, Figure 19
Response Time (Rise)	t_r	—	2	—	μ s	$V_{CC} = 10$ V, $I_C = 2$ mA, $R_L = 100\Omega$	Figure 1
Response Time (Fall)	t_f	—	3	—	μ s		
Turn-on Time	t_{on}	—	3	—	μ s		
Turn-off Time	t_{off}	—	3	—	μ s		
Turn-ON Time	t_{ON}	—	2	—	μ s	$V_{CC} = 5$ V, $I_F = 16$ mA, $R_L = 1.9$ k Ω	Figure 1, Figure 17
Storage Time	T_S	—	25	—	μ s		
Turn-OFF Time	t_{OFF}	—	40	—	μ s		
Common Mode Rejection Voltage	CMR	—	10	—	kV/ μ s	$T_A = 25^\circ$ C, $R_L = 470\Omega$, $V_{CM} = 1.5$ kV(peak), $I_F = 0$ mA, $V_{CC} = 9$ V, $V_{np} = 100$ mV	Figure 20

Figure 1 Switching Time Test Circuit

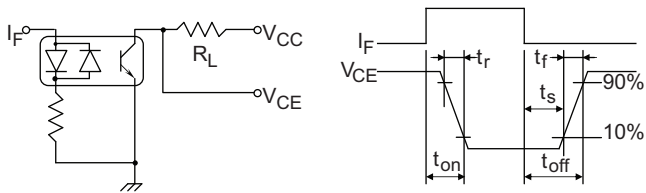

Figure 2 Frequency Response Test Circuit

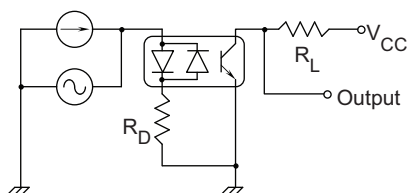

Figure 3 Forward Current vs. Ambient Temperature

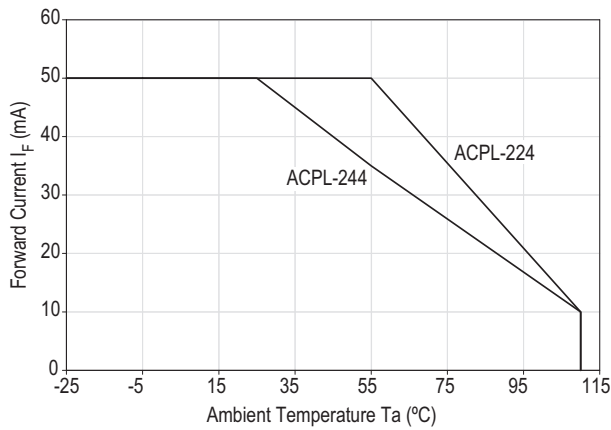

Figure 4 Collector Power Dissipation vs. Ambient Temperature

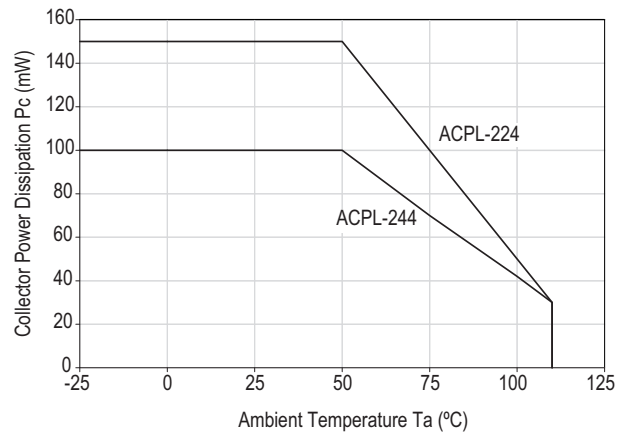

Figure 5 Pulse Forward Current vs. Duty Cycle Ratio

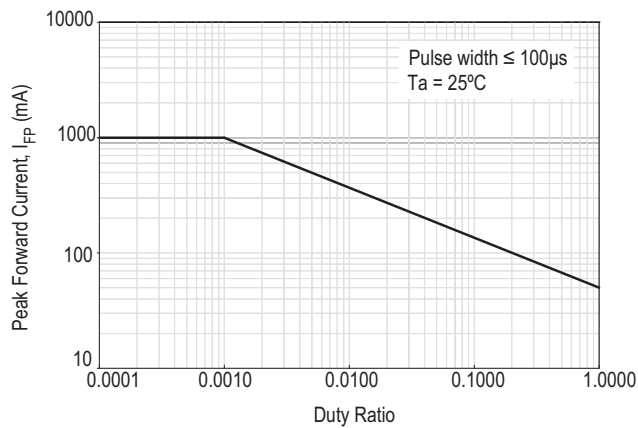

Figure 6 Forward Current vs. Forward Voltage

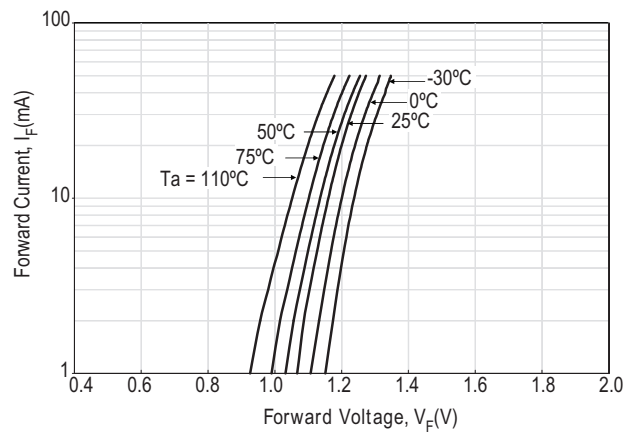

Figure 7 Forward Voltage Temperature Coefficient vs. Forward Current

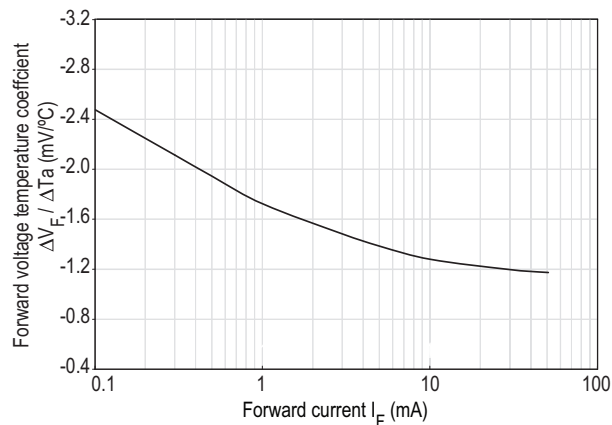

Figure 8 Pulse Forward Current vs. Pulse Forward Voltage

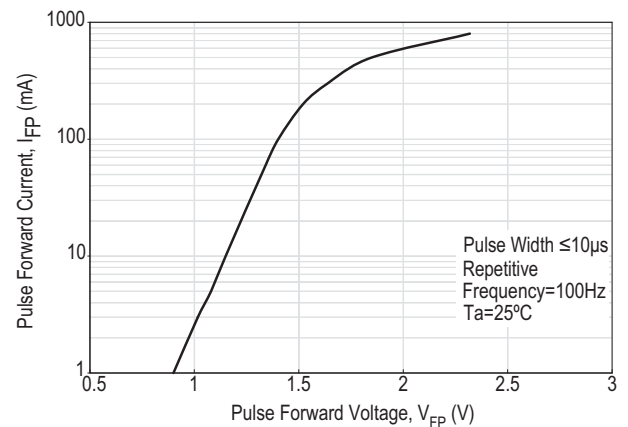

Figure 9 Collector Current vs. Collector-Emitter Voltage

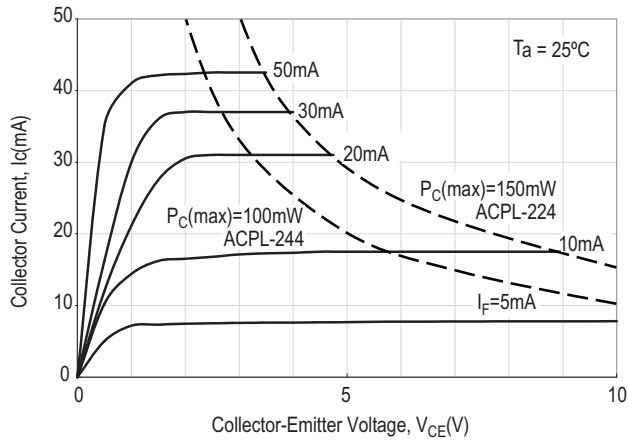

Figure 10 Collector Current vs. Small Collector-Emitter Voltage

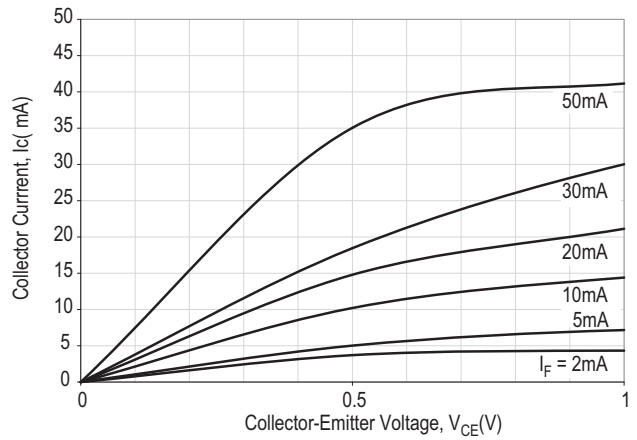

Figure 11 Collector Current vs. Forward Current

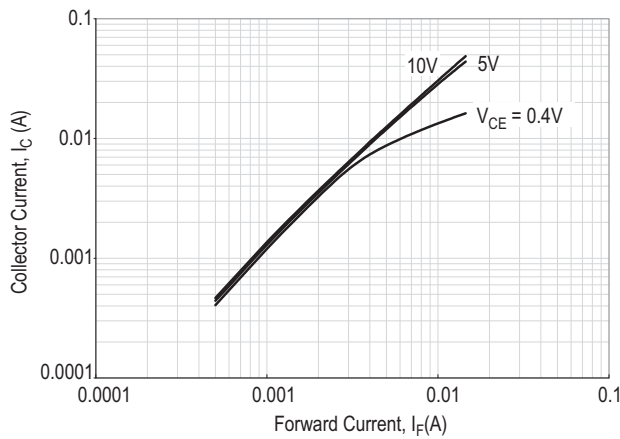

Figure 12 Collector Dark Current vs. Ambient Temperature

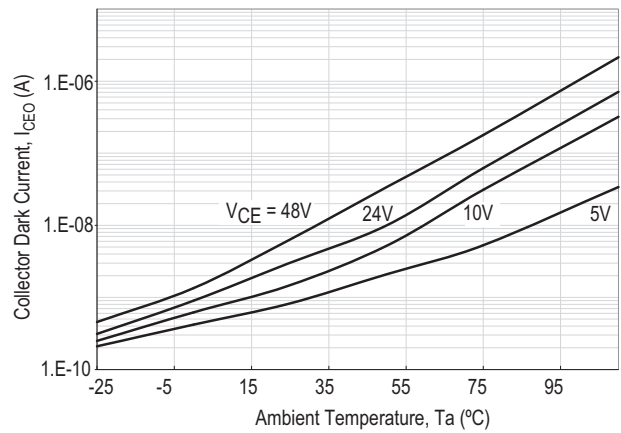

Figure 13 Current Transfer Ratio vs. Forward Current

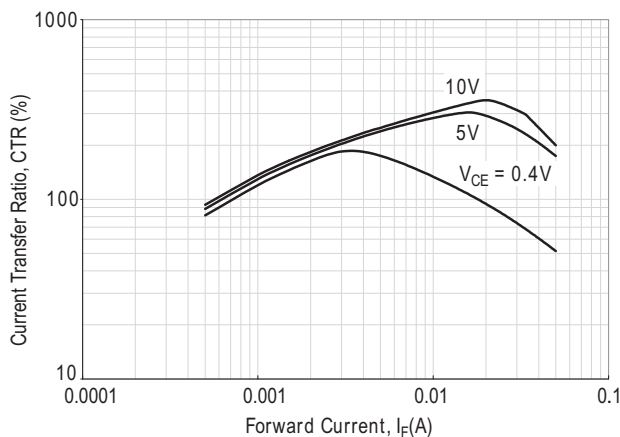

Figure 14 Collector-Emitter Saturation Voltage vs. Ambient Temperature

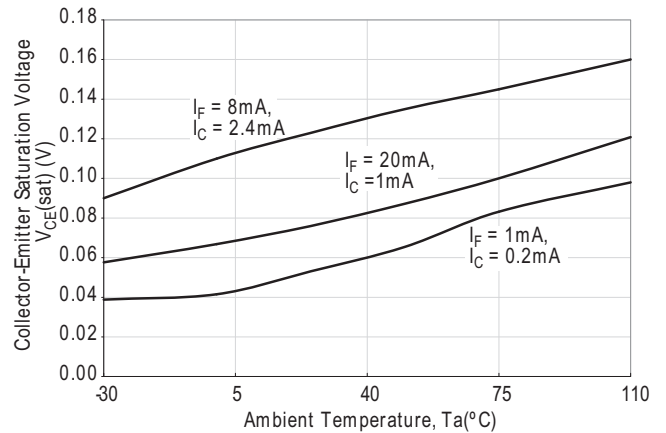

Figure 15 Collector Current vs. Ambient Temperature

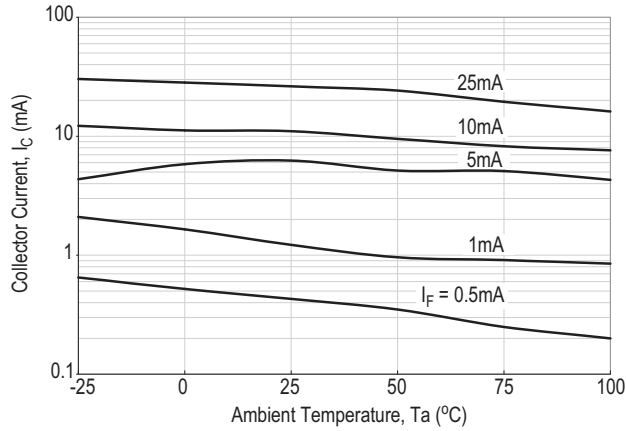

Figure 16 Switching Time vs. Load Resistance

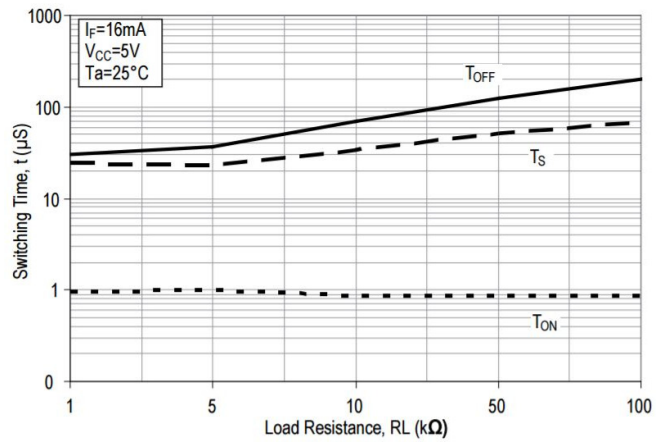

Figure 17 Switching Time vs. Ambient Temperature

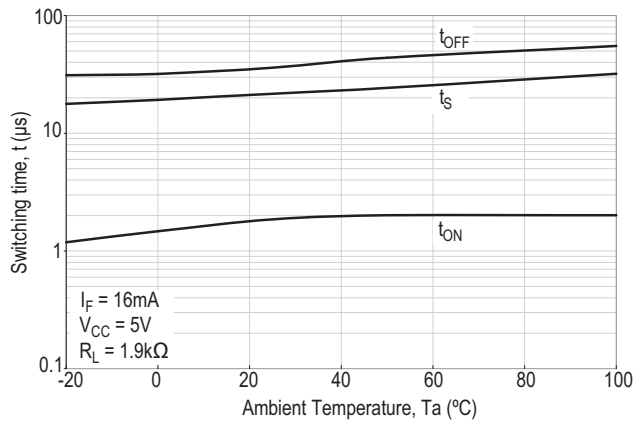

Figure 18 Collector-Emitter Saturation Voltage vs. Forward Current

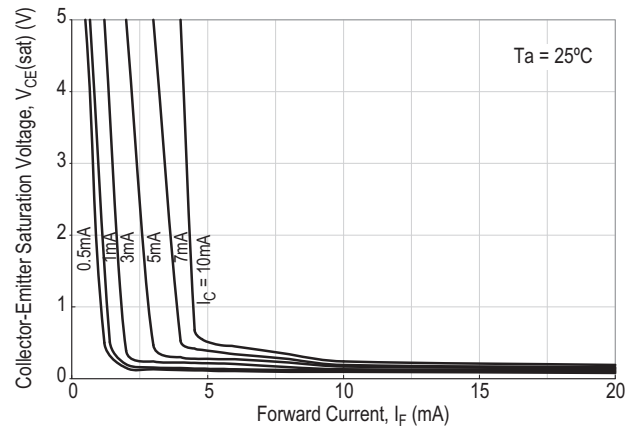

Figure 19 Frequency Response

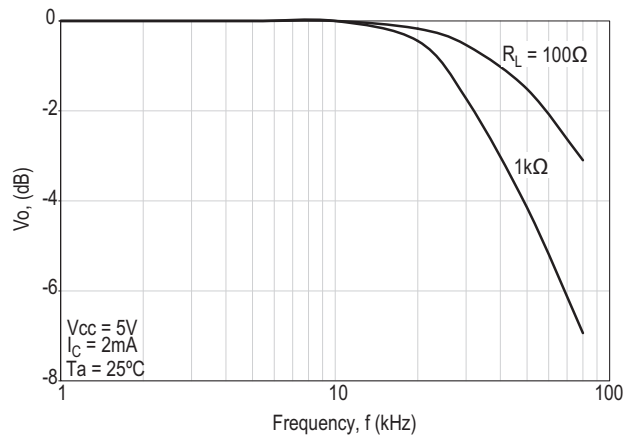
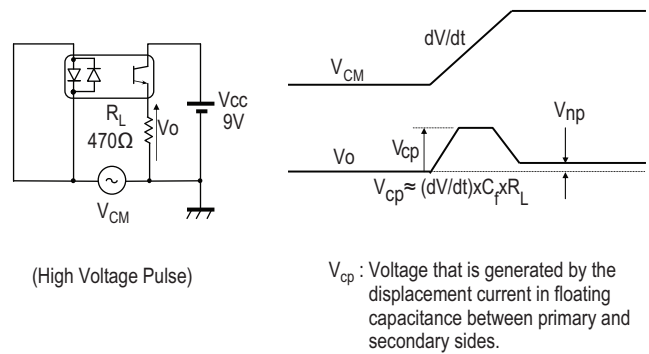

Figure 20 CMR Test Circuit



For product information and a complete list of distributors, please go to our web site: www.broadcom.com.

Broadcom, the pulse logo, Connecting everything, Avago Technologies, Avago, and the A logo are among the trademarks of Broadcom and/or its affiliates in the United States, certain other countries and/or the EU.

Copyright © 2010–2017 by Broadcom. All Rights Reserved.

The term "Broadcom" refers to Broadcom Limited and/or its subsidiaries. For more information, please visit www.broadcom.com.

Broadcom reserves the right to make changes without further notice to any products or data herein to improve reliability, function, or design.

Information furnished by Broadcom is believed to be accurate and reliable. However, Broadcom does not assume any liability arising out of the application or use of this information, nor the application or use of any product or circuit described herein, neither does it convey any license under its patent rights nor the rights of others.

AV02-0753EN – June 14, 2017



Mouser Electronics

Authorized Distributor

Click to View Pricing, Inventory, Delivery & Lifecycle Information:

[Broadcom Limited:](#)

[ACPL-224-500E](#) [ACPL-224-560E](#) [ACPL-244-500E](#) [ACPL-244-560E](#)