

# 900MHz Image-Reject Transceivers

## ABSOLUTE MAXIMUM RATINGS

V <sub>CC</sub> to GND .....	-0.3V to +5.5V	Continuous Power Dissipation (T <sub>A</sub> = +70°C)
TXIN Input Power (330Ω system) .....	-8dBm	SSOP (derate 9.5mW/°C above +70°C) .....
Voltage on TXOUT .....	-0.3V to (V <sub>CC</sub> + 1.0V)	762mW
Voltage on TXGAIN, LNAGAIN, TXON, RXON, VCOON, DIV1, MOD .....	-0.3V to (V <sub>CC</sub> + 0.3V)	Operating Temperature Range
RXIN Input Power .....	10dBm	MAX242_EAI/MAX246_EAI .....
TANK, TANK Input Power .....	2dBm	-40°C to +85°C
		Junction Temperature .....
		+150°C
		Storage Temperature Range .....
		-65°C to +165°C
		Lead Temperature (soldering, 10s) .....
		+300°C

Stresses beyond those listed under "Absolute Maximum Ratings" may cause permanent damage to the device. These are stress ratings only, and functional operation of the device at these or any other conditions beyond those indicated in the operational sections of the specifications is not implied. Exposure to absolute maximum rating conditions for extended periods may affect device reliability.

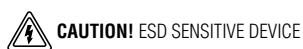

## DC ELECTRICAL CHARACTERISTICS

(V<sub>CC</sub> = +2.7V to +4.8V, no RF signals applied, LNAGAIN = TXGAIN = open, VCOON = 2.4V, RXON = TXON = MOD = DIV1 = 0.45V, PREGND = GND, T<sub>A</sub> = T<sub>MIN</sub> to T<sub>MAX</sub>. Typical values are at T<sub>A</sub> = +25°C, V<sub>CC</sub> = +3.3V, unless otherwise noted.) (Note 1)

PARAMETER	CONDITIONS	MIN	TYP	MAX	UNITS
Supply-Voltage Range		2.7		4.8	V
Oscillator Supply Current	PREGND = floating		9.5	14	mA
Prescaler Supply Current (divide-by-64/65 mode) (Note 2)			4.2	6	mA
Prescaler Supply Current (buffer mode) (Note 3)	DIV1 = 2.4V		5.4	8.5	mA
Receive Supply Current (Note 4)	RXON = 2.4V, PREGND = floating		23	36	mA
Transmitter Supply Current (Note 5)	RXON = 0.45V, TXON = 2.4V, PREGND = floating		26	42	mA
Shutdown Supply Current	VCOON = RXON = TXON = MOD = DIV1 = GND	T <sub>A</sub> = +25°C	0.5		μA
		T <sub>A</sub> = T <sub>MIN</sub> to T <sub>MAX</sub>	10		
Digital Input Voltage High	RXON, TXON, DIV1, VCOON, MOD	2.4			V
Digital Input Voltage Low	RXON, TXON, DIV1, VCOON, MOD			0.45	V
Digital Input Current	Voltage on any one digital input = V <sub>CC</sub> or GND		±1	±10	μA

**Note 1:** ≥25°C guaranteed by production test, <25°C guaranteed through correlation to worst-case temperature testing.

**Note 2:** Calculated by measuring the combined oscillator and prescaler supply current and subtracting the oscillator supply current.

**Note 3:** Calculated by measuring the combined oscillator and LO buffer supply current and subtracting the oscillator supply current.

**Note 4:** Calculated by measuring the combined receive and oscillator supply current and subtracting the oscillator supply current.

With LNAGAIN = GND, the supply current drops by 4.5mA.

**Note 5:** Calculated by measuring the combined transmit and oscillator supply current and subtracting the oscillator supply current.

# 900MHz Image-Reject Transceivers

MAX2420/MAX2421/MAX2422/MAX2460/MAX2463

## AC ELECTRICAL CHARACTERISTICS

(MAX242X/246X EV kit,  $V_{CC} = +3.3V$ ;  $f_{LO} = 925.7MHz$  (MAX2420),  $f_{LO} = 961MHz$  (MAX2421),  $f_{LO} = 985MHz$  (MAX2422),  $f_{LO} = 904.3MHz$  (MAX2460);  $f_{LO} = 805MHz$  (MAX2463);  $f_{RXIN} = 915MHz$ ;  $P_{RXIN} = -35dBm$ ;  $P_{TXIN} = -15dBm$  (330 $\Omega$ );  $LNAGAIN = 2V$ ;  $TXGAIN = V_{CC}$ ;  $V_{COON} = 2.4V$ ;  $R_{XON} = TXON = MOD = DIV1 = PREGND = GND$ ;  $T_A = +25^{\circ}C$ ; unless otherwise noted.)

PARAMETER	CONDITIONS		MIN	TYP	MAX	UNITS
<b>RECEIVER</b> (RXON = 2.4V)						
Input Frequency Range (Notes 6, 7)			800		1000	MHz
IF Frequency Range (Notes 6, 7)	MAX2420/MAX2460		8.5	10.7	12.5	MHz
	MAX2421		36	46	55	
	MAX2422		55	70	85	
	MAX2463		86	110	132	
Image Frequency Rejection			26	35		dB
Conversion Power Gain (Note 8)	$LNAGAIN = V_{CC}$ , $T_A = +25^{\circ}C$	MAX2420/MAX2421/MAX2460	20	22	24.5	dB
		MAX2422	19	21	23.5	
		MAX2463	18	20	22.5	
	$LNAGAIN = V_{CC}$ , $T_A = T_{MIN}$ to $T_{MAX}$ (Note 6)	MAX2420/MAX2421/MAX2460	19.5		25	
		MAX2422	18		24	
		MAX2463	17		23	
$LNAGAIN = 1V$				12		
$LNAGAIN = GND$				-16		
Noise Figure (Notes 6, 8)	$DIV1 = V_{CC}$	$LNAGAIN = V_{CC}$		4	5	dB
		$LNAGAIN = 1V$		12		
Input Third-Order Intercept (Notes 6, 9)	$LNAGAIN = V_{CC}$		-19	-17		dBm
	$LNAGAIN = 1V$			-8		
Input 1dB Compression	$LNAGAIN = V_{CC}$			-26		dBm
	$LNAGAIN = 1V$			-18		
LO to RXIN Leakage	Receiver on or off			-60		dBm
Receiver Turn-On Time	(Note 10)			500		ns
<b>TRANSMITTER</b> (TXON = 2.4V)						
Output Frequency Range (Notes 6, 7)			800		1000	MHz
IF Frequency Range	MAX2420/MAX2460		8.5	10.7	12.5	MHz
	MAX2421		36	46	55	
	MAX2422		55	70	85	
	MAX2463		86	110	132	
Image Frequency Rejection			26	35		dB
Conversion Gain	$T_A = +25^{\circ}C$	MAX2420/2460	11	13.5	16	dB
		MAX2421	10	12.5	15	
		MAX2422	9	12	14.5	
		MAX2463	8	11	13.5	
	$T_A = T_{MIN}$ to $T_{MAX}$ (Note 6)	MAX2420/2460	10.5		16.5	
		MAX2421	10		15.5	
		MAX2463	8		14	

# 900MHz Image-Reject Transceivers

MAX2420/MAX2421/MAX2422/MAX2460/MAX2463

## AC ELECTRICAL CHARACTERISTICS (continued)

(MAX242X/246X EV kit,  $V_{CC} = +3.3V$ ;  $f_{LO} = 925.7MHz$  (MAX2420),  $f_{LO} = 961MHz$  (MAX2421),  $f_{LO} = 985MHz$  (MAX2422),  $f_{LO} = 904.3MHz$  (MAX2460);  $f_{LO} = 805MHz$  (MAX2463);  $f_{RXIN} = 915MHz$ ;  $P_{RXIN} = -35dBm$ ;  $P_{TXIN} = -15dBm$  (330 $\Omega$ );  $LNAGAIN = 2V$ ;  $TXGAIN = V_{CC}$ ;  $V_{COON} = 2.4V$ ;  $R_{XON} = TXON = MOD = DIV1 = PREGND = GND$ ;  $T_A = +25^{\circ}C$ ; unless otherwise noted.)

PARAMETER	CONDITIONS	MIN	TYP	MAX	UNITS
Output 1dB Compression			2		dBm
Output Third-Order Intercept (Note 11)			11		dBm
LO to TXOUT Suppression (Note 12)			34		dBc
Noise Figure			23		dB
TXGAIN Control Slope (Note 13)	$1V \leq TXGAIN \leq 2V$		33		dB/V
Gain Control Range (Note 13)			36		dB
Transmitter Turn-On Time (Note 14)			400		ns
<b>OSCILLATOR AND PRESCALER</b>					
Oscillator Frequency Range (Notes 6, 15)		690		1100	MHz
Oscillator Phase Noise	10kHz offset (Note 16)		82		dBc/Hz
Oscillator Pulling	Standby to TX, or standby to RX		8		kHz
	RX to TX with $P_{RXIN} = -45dBm$ (RX mode) to $P_{RXIN} = 0dBm$ (TX mode) (Note 17)		70		
Prescaler Output Level	$Z_L = 100k\Omega \parallel 10pF$		500		mV <sub>P-P</sub>
Oscillator Buffer Output Level (Note 6)	$DIV1 = 2.4V, Z_L = 50\Omega, T_A = +25^{\circ}C$	-11	-8		dBm
	$DIV1 = 2.4V, Z_L = 50\Omega, T_A = T_{MIN} \text{ to } T_{MAX}$	-12			
Required Modulus Setup Time (Note 6)	Divide-by-64/65 mode (Note 18)	10			ns
Required Modulus Hold Time (Note 6)	Divide-by-64/65 mode (Note 18)	0			ns

**Note 6:** Guaranteed by design and characterization.

**Note 7:** Image rejection typically falls to 30dBc at the frequency extremes.

**Note 8:** Refer to the *Typical Operating Characteristics* for plots showing receiver gain vs. LNAGAIN voltage, input IP3 vs. LNAGAIN voltage, and noise figure vs. LNAGAIN voltage.

**Note 9:** Two tones at  $P_{RXIN} = -45dBm$  each,  $f_1 = 915.0MHz$  and  $f_2 = 915.2MHz$ .

**Note 10:** Time delay from  $R_{XON} = 0.45V$  to  $R_{XON} = 2.4V$  transition to the time the output envelope reaches 90% of its final value.

**Note 11:** Two tones at  $P_{TXIN} = -21dBm$  each (330 $\Omega$ ),  $f_1 = 10.6MHz$ ,  $f_2 = 10.8MHz$  (MAX2420/MAX2460),  $f_1 = 45.9MHz$ ,  $f_2 = 46.1MHz$  (MAX2421),  $f_1 = 69.9MHz$ ,  $f_2 = 70.1MHz$  (MAX2422).

**Note 12:** Refer to the *Typical Operating Characteristics* for statistical data.

**Note 13:** Refer to the *Typical Operating Characteristics* for a plot showing transmitter gain vs. TXGAIN voltage.

**Note 14:** Time delay from  $TXON = 0.45V$  to  $TXON = 2.4V$  transition to the time the output envelope reaches 90% of its final value.

**Note 15:** Refers to useable operating range. Tuning range of any given tank circuit design is typically much narrower (refer to Figure 2).

**Note 16:** Using tank components  $L_3 = 5.0nH$  (Coilcraft A02T),  $C_2 = C_3 = C_{26} = 3.3pF$ ,  $R_6 = R_7 = 10\Omega$ .

**Note 17:** This approximates a typical application in which TXOUT is followed by an external PA and a T/R switch with finite isolation.

**Note 18:** Relative to the rising edge of PREOUT.

# 900MHz Image-Reject Transceivers

## Typical Operating Characteristics

(MAX242X/246X EV kit,  $V_{CC} = +3.3V$ ;  $f_{LO} = 925.7MHz$  (MAX2420),  $f_{LO} = 961MHz$  (MAX2421),  $f_{LO} = 985MHz$  (MAX2422),  $f_{LO} = 904.3MHz$  (MAX2460);  $f_{LO} = 805MHz$  (MAX2463);  $f_{RXIN} = 915MHz$ ;  $P_{RXIN} = -35dBm$ ;  $P_{TXIN} = -15dBm$  (330 $\Omega$ );  $LNAGAIN = 2V$ ;  $TXGAIN = V_{CC}$ ;  $V_{COON} = 2.4V$ ;  $RXON = TXON = MOD = DIV1 = PREGND = GND$ ;  $T_A = +25^{\circ}C$ ; unless otherwise noted.)

MAX2420/MAX2421/MAX2422/MAX2460/MAX2463

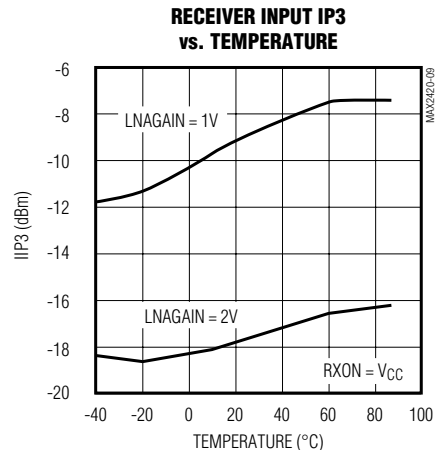
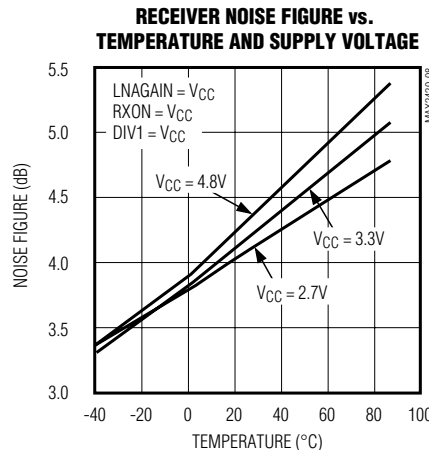
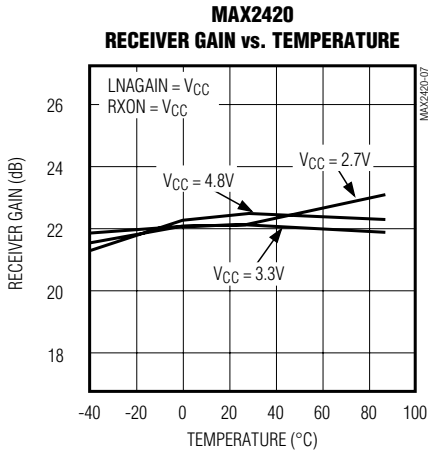
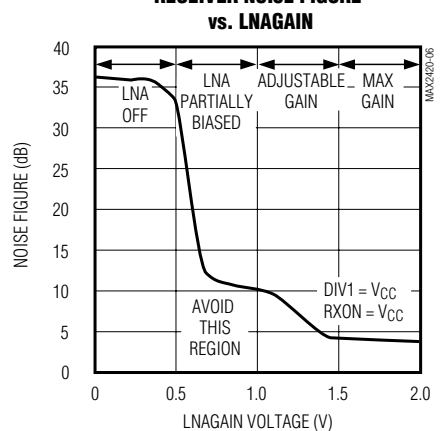
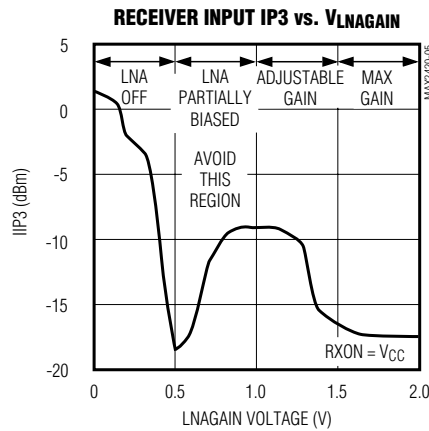
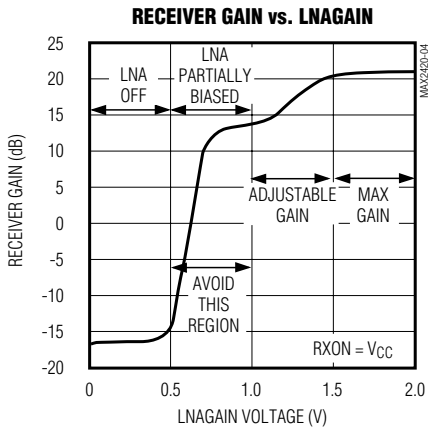
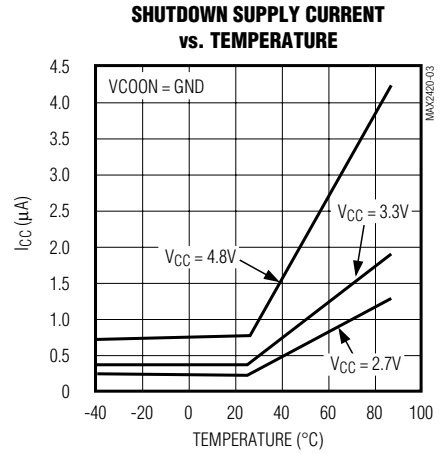
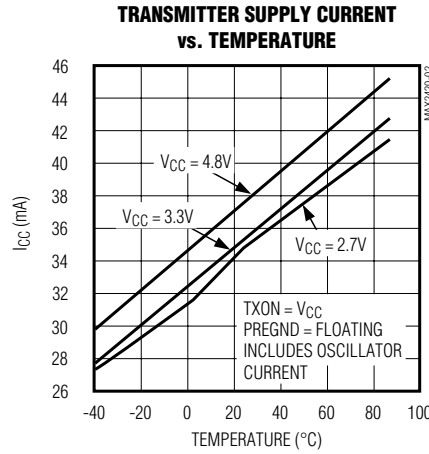
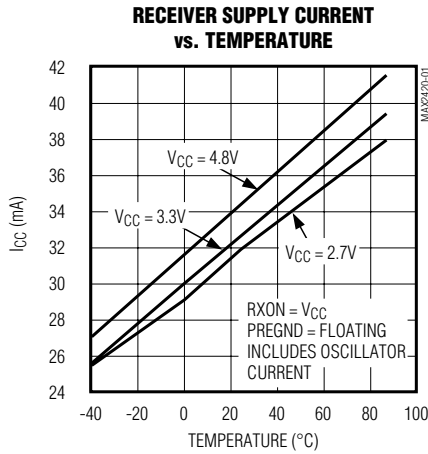

# 900MHz Image-Reject Transceivers

## Typical Operating Characteristics (continued)

(MAX242X/246X EV kit,  $V_{CC} = +3.3V$ ;  $f_{LO} = 925.7MHz$  (MAX2420),  $f_{LO} = 961MHz$  (MAX2421),  $f_{LO} = 985MHz$  (MAX2422),  $f_{LO} = 904.3MHz$  (MAX2460);  $f_{LO} = 805MHz$  (MAX2463);  $f_{RXIN} = 915MHz$ ;  $P_{RXIN} = -35dBm$ ;  $P_{TXIN} = -15dBm$  ( $330\Omega$ );  $LNAGAIN = 2V$ ;  $TXGAIN = V_{CC}$ ;  $V_{COON} = 2.4V$ ;  $RXON = TXON = MOD = DIV1 = PREGND = GND$ ;  $T_A = +25^\circ C$ ; unless otherwise noted.)

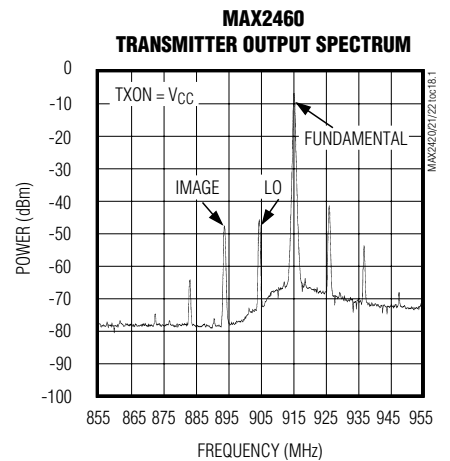
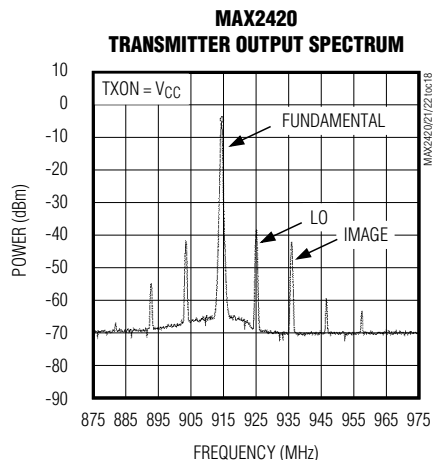
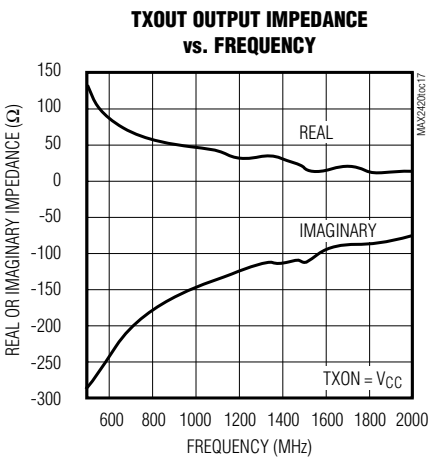
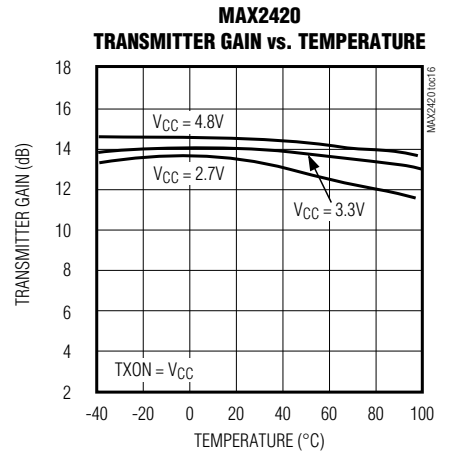
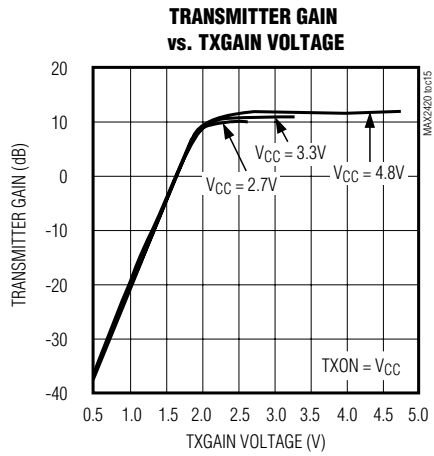
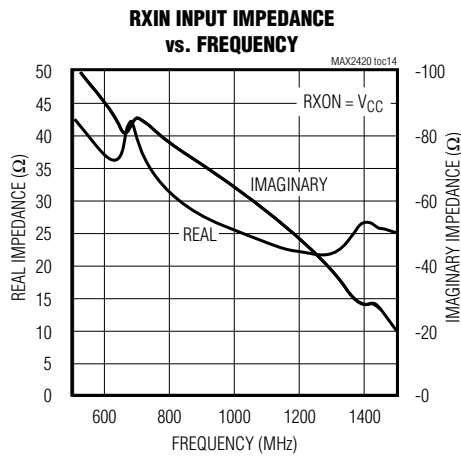
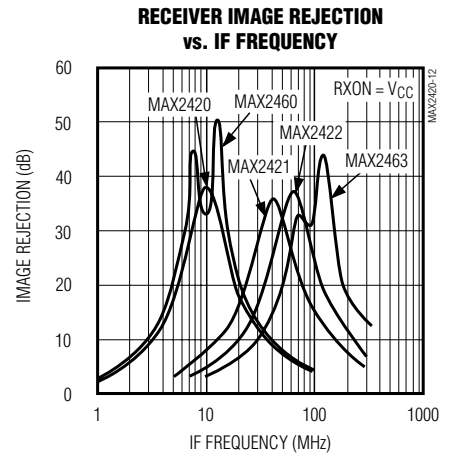
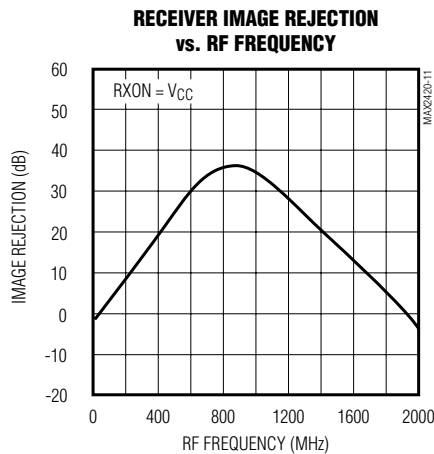
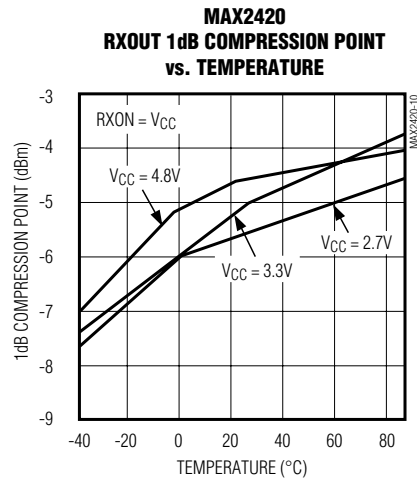

# 900MHz Image-Reject Transceivers

## Typical Operating Characteristics (continued)

(MAX242X/246X EV kit,  $V_{CC} = +3.3V$ ;  $f_{LO} = 925.7MHz$  (MAX2420),  $f_{LO} = 961MHz$  (MAX2421),  $f_{LO} = 985MHz$  (MAX2422),  $f_{LO} = 904.3MHz$  (MAX2460);  $f_{LO} = 805MHz$  (MAX2463);  $f_{RXIN} = 915MHz$ ;  $P_{RXIN} = -35dBm$ ;  $P_{TXIN} = -15dBm$  (330 $\Omega$ );  $LNAGAIN = 2V$ ;  $TXGAIN = V_{CC}$ ;  $V_{COON} = 2.4V$ ;  $R_{XON} = TXON = MOD = DIV1 = PREGND = GND$ ;  $T_A = +25^{\circ}C$ ; unless otherwise noted.)

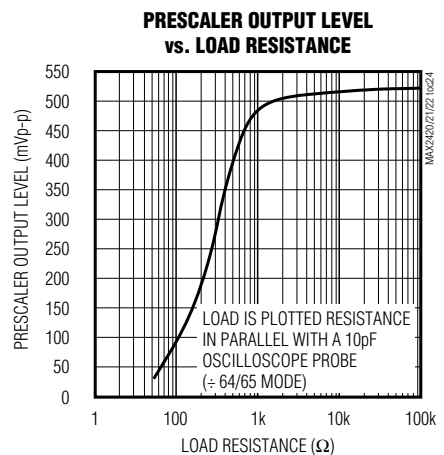
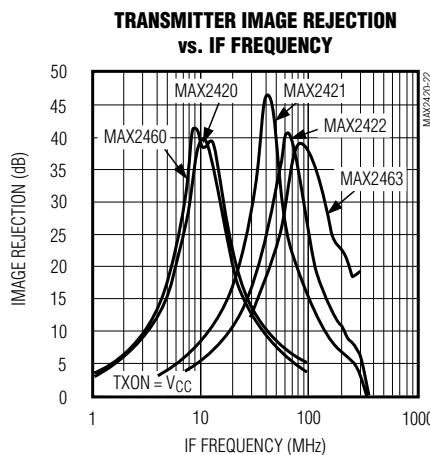
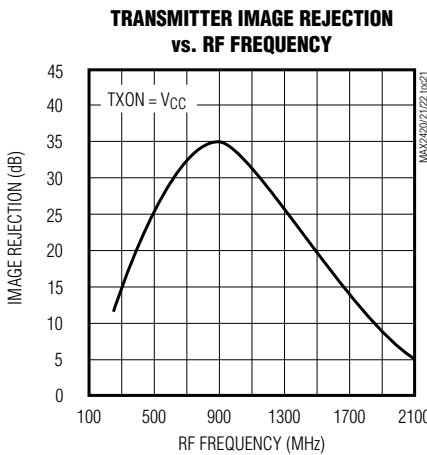
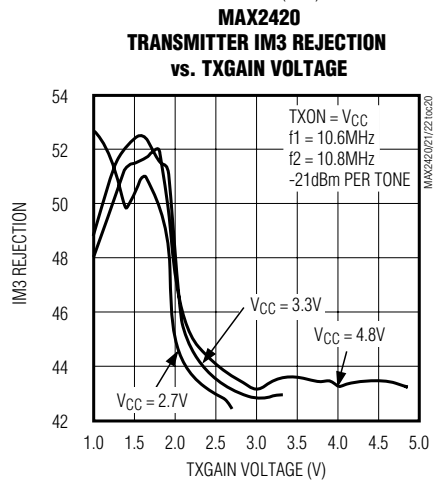
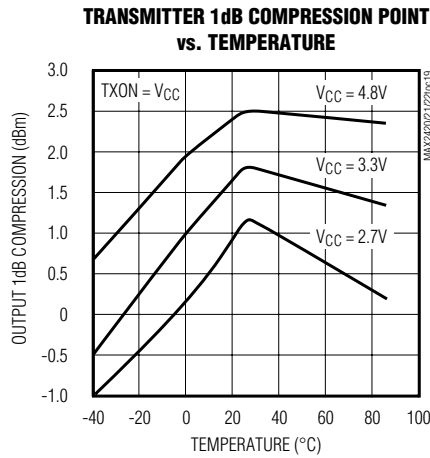
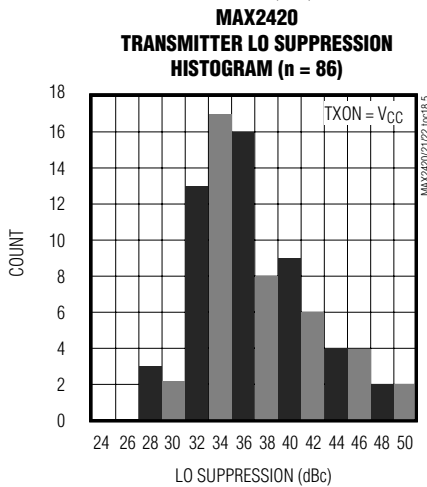
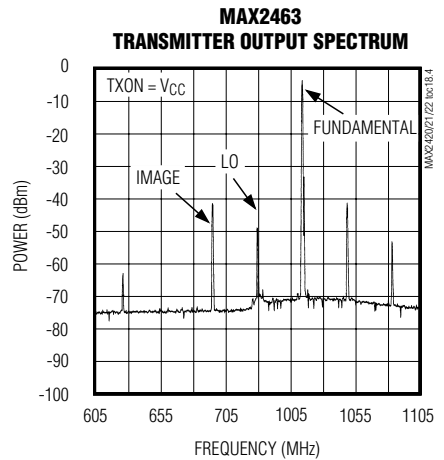
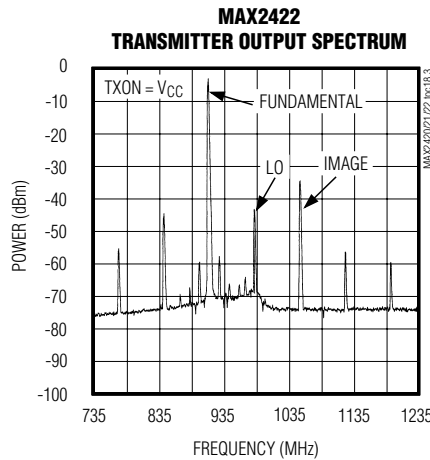
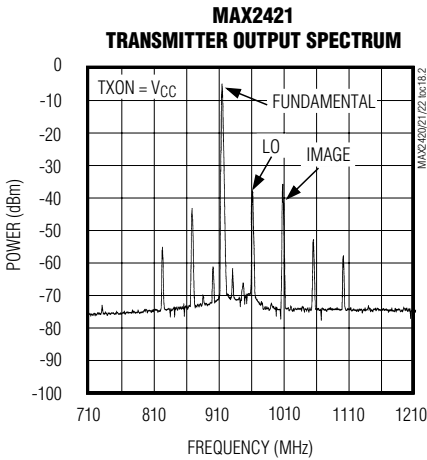

MAX2420/MAX2421/MAX2422/MAX2460/MAX2463

# 900MHz Image-Reject Transceivers

## Pin Description

PIN	NAME	FUNCTION
1	V <sub>CC</sub>	Supply-Voltage Input for Master Bias Cell. Bypass with a 47pF low-inductance capacitor and 0.1μF to GND (pin 28, if possible).
2	CAP1	Receive Bias Compensation Pin. Bypass with a 47pF low-inductance capacitor and 0.01μF to GND. Do not make any other connections to this pin.
3	RXOUT	Single-Ended, 330Ω IF Output. AC couple to this pin.
4	TXGAIN	Transmit Gain-Control Input. Connect to V <sub>CC</sub> for highest gain and best temperature stability. When driven with a control voltage, the IF buffer gain can be adjusted over a 36dB range (see <i>Typical Operating Characteristics</i> ).
5	RXIN	Receiver RF Input, single-ended. The input match shown in Figure 1 maintains an input VSWR of better than 2:1 from 902MHz to 928MHz.
6	V <sub>CC</sub>	Supply Voltage Input for Receive Low-Noise Amplifier. Bypass with a 47pF low-inductance capacitor to GND (pin 7 if possible).
7	GND	Ground Connection for Receive Low-Noise Amplifier
8	GND	Ground Connection for Signal-Path Blocks, except LNA
9	TXOUT	PA Predriver Output. See Figure 1 for an example matching network, which provides better than 2:1 VSWR from 902MHz to 928MHz.
10	LNAGAIN	Low-Noise Amplifier Gain-Control Input. Drive this pin high for maximum gain. When LNAGAIN is pulled low, the LNA is capacitively bypassed and the supply current is reduced by 4.5mA. This pin can also be driven with an analog voltage to adjust the LNA gain in intermediate states. Refer to the Receiver Gain vs. LNAGAIN Voltage graph in the <i>Typical Operating Characteristics</i> , as well as Table 1.
11	V <sub>CC</sub>	Supply Voltage Input for Signal-Path Blocks, except LNA. Bypass with a 47pF low-inductance capacitor and 0.01μF to GND (pin 8, if possible).
12	TXIN	Transmitter IF Input, 330Ω, single-ended. AC couple to this pin.
13	N.C.	No Connect. Not internally connected.
14	CAP2	Transmit Bias Compensation Pin. Bypass with a 47pF low-inductance capacitor and 0.01μF to GND. Do not make any other connections to this pin.
15	TXON	Driving TXON with a logic high enables the transmit IF variable-gain amplifier, upconverter mixer, and PA predriver. VCOON must also be high.
16	RXON	Driving RXON with a logic high enables the LNA, receive mixer, and IF output buffer. VCOON must also be high.
17	VCOON	Driving VCOON with a logic high turns on the VCO, phase shifters, VCO buffers, and prescaler. The prescaler can be selectively disabled by floating the PREGND pin.
18	DIV1	Driving DIV1 with a logic high disables the divide-by-64/65 prescaler and connects the PREOUT pin directly to an oscillator buffer amplifier, which outputs -8dBm into a 50Ω load. Tie DIV1 low for divide-by-64/65 operation. Pull this pin low when in shutdown to minimize off current.
19	MOD	Modulus Control for the Divide-by-64/65 Prescaler: high = divide-by-64, low = divide-by-65. Note that the DIV1 pin must be at logic low when using the prescaler mode.
20	PREGND	Ground connection for the Prescaler. Tie PREGND to ground for normal operation. Leave floating to disable the prescaler and the output buffer. Tie MOD and DIV1 to ground and leave PREOUT floating when disabling the prescaler.
21	PREOUT	Prescaler/Oscillator Buffer Output. In divide-by-64/65 mode (DIV1 = low), the output level is 500mVp-p into a high-impedance load. In divide-by-1 mode (DIV1 = high), this output delivers -8dBm into a 50Ω load. AC couple to this pin.

# 900MHz Image-Reject Transceivers

## Pin Description (continued)

PIN	NAME	FUNCTION
22	VCC	Supply-Voltage Input for Prescaler. Bypass with a 47pF low-inductance capacitor and 0.01μF to GND (pin 20 if possible).
23	VCC	Supply-Voltage Input for VCO and Phase Shifters. Bypass with a 47pF low-inductance capacitor to GND (pin 26 if possible).
24	TANK	Differential Oscillator Tank Port. See <i>Applications Information</i> for information on tank circuits or on using an external oscillator.
25	TANK	Differential Oscillator Tank Port. See <i>Applications Information</i> for information on tank circuits or on using an external oscillator.
26	GND	Ground Connection for VCO and Phase Shifters
27	GND	Ground (substrate)
28	GND	Ground Connection for Master Bias Cell

MAX2420/MAX2421/MAX2422/MAX2460/MAX2463

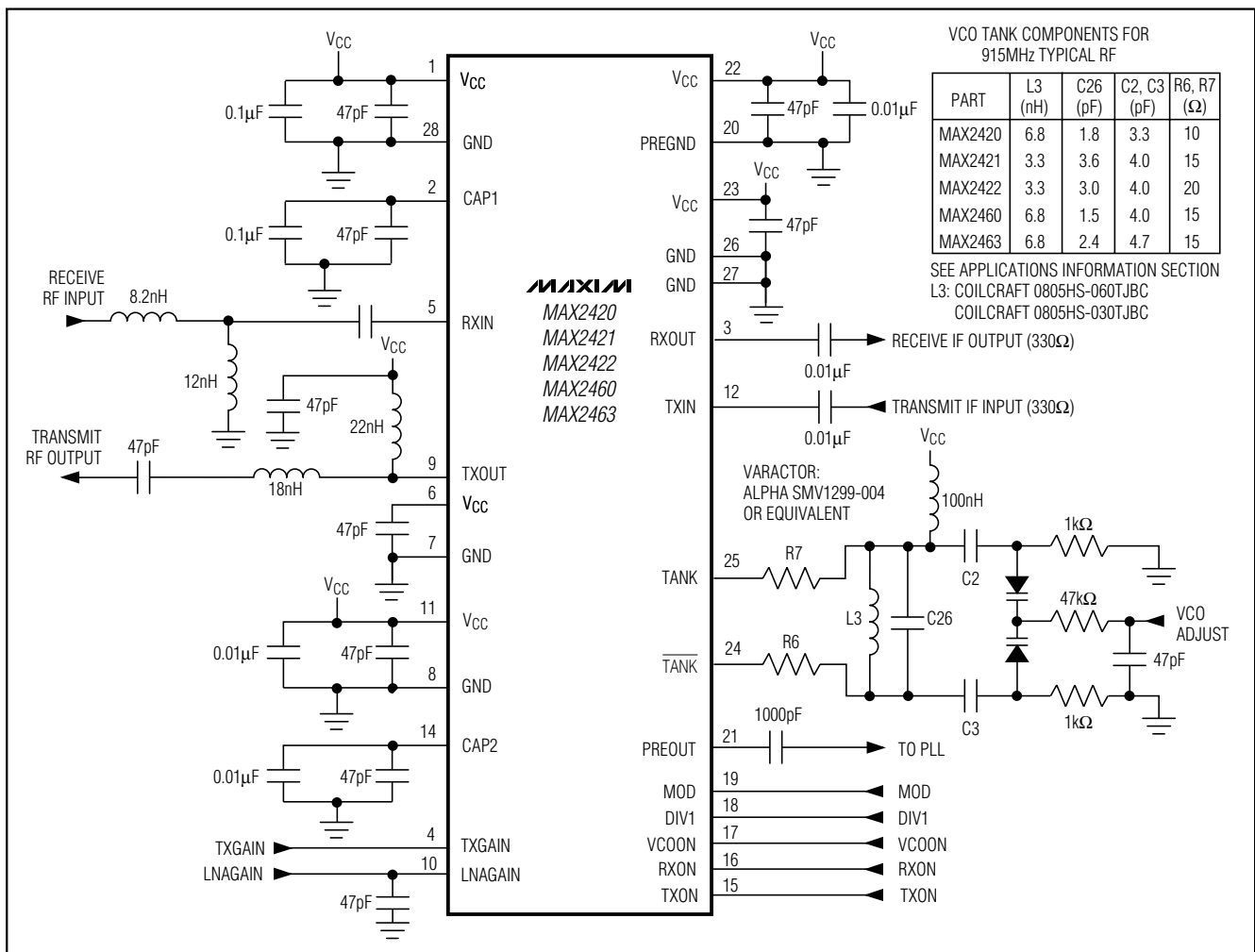

Figure 1. Typical Operating Circuit



# 900MHz Image-Reject Transceivers

## Detailed Description

The following sections describe each of the functional blocks shown in the *Functional Diagram*.

### Receiver

The MAX2420/MAX2421/MAX2422/MAX2460/MAX2463's receive path consists of a 900MHz low-noise amplifier, an image-reject mixer, and an IF buffer amplifier.

The LNA's gain and biasing are adjustable through the LNAGAIN pin. Proper operation of this pin can provide optimum performance over a wide range of signal levels. The LNA can be placed in four modes by applying a DC voltage on the LNAGAIN pin. See Table 1, as well as the relevant *Typical Operating Characteristics* plots.

At low LNAGAIN voltages, the LNA is shut off, and the input signal capacitively couples directly into the mixer to provide maximum linearity for large-signal operation (receiver close to transmitter). As the LNAGAIN voltage is raised, the LNA begins to turn on. Between 0.5V and 1V at LNAGAIN, the LNA is partially biased and behaves like a Class C amplifier. Avoid this operating mode for applications where linearity is a concern. As the LNAGAIN voltage reaches 1V, the LNA is fully biased into Class A mode, and the gain is monotonically adjustable at LNAGAIN voltages above 1V. See the Receiver Gain, Receiver IP3, and Receiver Noise Figure vs. LNAGAIN plots in the *Typical Operating Characteristics* for more information.

The downconverter is implemented using an image-reject mixer consisting of an input buffer with two outputs, each of which is fed to a double-balanced mixer. The local-oscillator (LO) port of each mixer is driven from a quadrature LO. The LO is generated from an on-chip oscillator and an external tank circuit. Its signal is buffered and split into phase shifters, which provide 90° of phase shift across their outputs. This pair of LO signals is fed to the mixers. The mixers' outputs are then passed through a second pair of phase shifters, which provide a 90° phase shift across their outputs. The

**Table 1. LNA Modes**

LNAGAIN VOLTAGE (V)	MODE
$0 < V \leq 0.5$	LNA capacitively bypassed, minimum gain, maximum IP3
$0.5 < V < 1.0$	LNA partially biased. <b>Avoid this mode</b> —the LNA operates in a Class C manner
$1.0 < V \leq 1.5$	LNA gain is monotonically adjustable
$1.5 < V \leq V_{CC}$	LNA at maximum gain (remains monotonic)

resulting mixer outputs are then summed together. The final phase relationship is such that the desired signal is reinforced and the image signal is canceled. The down-converter mixer output appears on the RXOUT pin, a single-ended 330Ω output.

### Transmitter

The transmitter operates similarly to the receiver, but with the phase shifters at the mixer inputs. The transmitter consists of an input buffer amplifier with more than 36dB of gain-adjustment range via the TXGAIN pin. This buffer's output is split internally into an in-phase (I) and a quadrature-phase (Q) path. IF phase-shifting networks give the Q-channel path a 90° phase shift with respect to the I channel. The I and Q signals are input to a pair of double-balanced mixers, driven with quadrature LO. The mixer outputs are then summed, canceling the image component. The image-rejected output signal is fed to the PA predriver, which outputs typically -3dBm on the TXOUT pin.

Since the transmit and receive sections share an LO and an IF frequency, interference results if both sections are active at the same time.

### Phase Shifters

MAX2420/MAX2421/MAX2422/MAX2460/MAX2463 devices use passive networks to provide quadrature phase shifting for the receive IF, transmit IF, and LO signals. Because these networks are frequency selective, proper part selection is important. Image rejection degrades as the IF and RF move away from the designed optimum frequencies. The MAX2420/MAX2421/MAX2422's phase shifters are arranged such that the LO frequency is higher than the RF carrier frequency (high-side injection), while the MAX2460/MAX2463's phase shifters are arranged such that the LO frequency is lower than the RF carrier frequency (low-side injection). Refer to the *Selector Guide*.

### Local Oscillator (LO)

The on-chip LO is formed by an emitter-coupled differential pair. An external LC resonant tank sets the oscillation frequency. A varactor diode is typically used to create a voltage-controlled oscillator (VCO). See the *Applications Information* section for an example VCO tank circuit.

The LO may be overdriven in applications where an external signal is available. The external LO signal should be about 0dBm from 50Ω, and should be AC coupled into either the TANK or  $\overline{\text{TANK}}$  pin. Both TANK and  $\overline{\text{TANK}}$  require pull-up resistors to VCC. See the *Applications Information* section for details.

# 900MHz Image-Reject Transceivers

MAX2420/MAX2421/MAX2422/MAX2460/MAX2463

The local oscillator is resistant to LO pulling caused by changes in load impedance that occur as the part is switched from standby mode, with just the oscillator running to either transmit or receive mode. The amount of LO pulling is affected if there is power at the RXIN port in transmit mode. The most common cause of this is imperfect isolation in an external transmit/receive (T/R) switch. The *AC Electrical Characteristics* table contains specifications for this case as well.

## Prescaler

The on-chip prescaler can be used in two different modes: as a dual-modulus divide-by-64/65, or as oscillator buffer amplifier. The DIV1 pin controls this function. When DIV1 is low, the prescaler is in dual-modulus divide-by-64/65 mode; when it is high, the prescaler is disabled and the oscillator buffer amplifier is enabled. The buffer typically outputs -8dBm into a 50Ω load. To minimize shutdown supply current, pull the DIV1 pin low when in shutdown mode.

In divide-by-64/65 mode, the division ratio is controlled by the MOD pin. When MOD is high, the prescaler is in divide-by-64 mode; when it is low, it divides the LO frequency by 65. The DIV1 pin must be at a logic low in this mode.

To disable the prescaler entirely, leave PREGND and PREOUT floating. Also tie the MOD and DIV1 pins to GND. Disabling the prescaler does not affect operation of the VCO stage.

## Power Management

MAX2420/MAX2421/MAX2422/MAX2460/MAX2463 supports four different power-management features to conserve battery life. The VCO section has its own control pin (VCOON), which also serves as a master bias pin. When VCOON is high, the LO, quadrature LO phase shifters, and prescaler or LO buffer are all enabled. The VCO can be powered up prior to either transmitting or receiving, to allow it to stabilize. For transmit-to-receive switching, the receiver and transmitter sections have their own enable control inputs, RXON and TXON. With VCOON high, bringing RXON high enables the receive path, which consists of the LNA, image-reject mixers, and IF output buffer. When this pin is low, the receive path is inactive. The TXON input enables the IF adjustable-gain amplifier, upconverter mixer, and PA predriver. VCOON must be high for the transmitter to operate. When TXON is low, the transmitter is off.

To disable all chip functions and reduce the supply current to typically less than 0.5μA, pull VCOON, DIV1, MOD, RXON, and TXON low.

## Applications Information

### Oscillator Tank

The on-chip oscillator requires a parallel-resonant tank circuit connected across TANK and  $\overline{\text{TANK}}$ . Figure 2 shows an example of an oscillator tank circuit. Inductor L4 provides DC bias to the tank ports. Inductor L3, capacitor C26, and the series combination of capacitors C2, C3, and both halves of the varactor diode capacitance set the resonant frequency as follows:

$$f_r = \frac{1}{2\pi\sqrt{(L3)(C_{EFF})}}$$

$$C_{EFF} = \frac{1}{\left(\frac{1}{C2} + \frac{1}{C3} + \frac{2}{C_{D1}}\right)} + C26$$

where  $C_{D1}$  is the capacitance of one varactor diode.

Choose tank components according to your application needs, such as phase-noise requirements, tuning range, and VCO gain. High-Q inductors such as air-core micro springs yield low phase noise. Use a low tolerance inductor (L3) for predictable oscillation frequency. Resistors R6 and R7 can be chosen from 0 to 20Ω to reduce the Q of parasitic resonance due to series package inductance (L<sub>T</sub>). Keep R6 and R7 as small as possible to minimize phase noise, yet large enough to ensure oscillator start up in fundamental mode. Oscillator start-up is most critical with high tuning bandwidth (low tank Q) and high temperature. Capacitors C2 and C3 couple in the varactor. Light

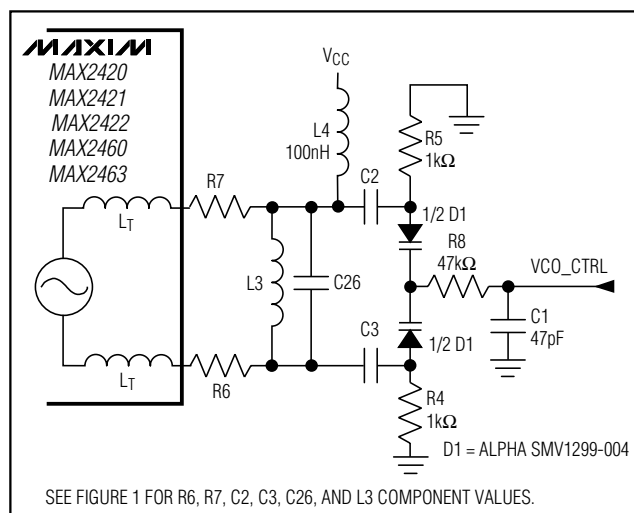

Figure 2. Oscillator Tank Schematic, Using the On-Chip VCO

# 900MHz Image-Reject Transceivers

coupling of the varactor is a way to reduce the effects of high-varactor tolerance and increase loaded Q. For a wider tuning range use larger values for C2 and C3 or a varactor with a large capacitance ratio. Capacitor C26 is used to trim the tank oscillator frequency. Larger values for C26 helps negate the effect of stray PCB capacitance and parasitic inductor capacitance (L3). Choose a low-tolerance capacitor for C26.

For applications that require a wide tuning range and low phase noise, a series coupled resonant tank may be required as shown in Figure 4. This tank uses the package inductance in series with inductors L1, L2, and capacitance of varactor D1 to set the net equivalent inductance which resonates in parallel with the internal oscillator capacitance. Inductors L1 and L2 can be implemented as microstrip inductors, saving component cost. Bias is provided to the tank port through

chokes L3 and L5. R1 and R3 should be chosen large enough to de-Q the parasitic resonance due to L3 and L5, but small enough to minimize the voltage drop across them due to bias current. Values for R1 and R3 should be kept between 0 and 50Ω. Proper high-frequency bypassing (C1) should be used for the bias voltage to eliminate power supply noise from entering the tank.

### Oscillator-Tank PC Board Layout

The parasitic PC board capacitance, as well as PCB trace inductance and package inductance, can affect oscillation frequency, so be careful in laying out the PC board for the oscillator tank. Keep the tank layout as symmetrical, tightly packed, and close to the device as possible to minimize LO feedthrough. When using a PC board with a ground plane, a cut-out in the ground plane (and any other planes) below the oscillator tank reduces parasitic capacitance.

### Using an External Oscillator

If an external 50Ω LO signal source is available, it can be used as an input to the TANK or  $\overline{\text{TANK}}$  pin in place of the on-chip oscillator (Figure 3). The oscillator signal is AC coupled into the TANK pin and has a level of about 0dBm from a 50Ω source. For proper biasing of the oscillator input stage, the TANK and  $\overline{\text{TANK}}$  pins must be pulled up to the VCC supply via 50Ω resistors.

If the application requires overdriving the internal oscillator, the pull-up resistors can be increased in order to save power. If a differential LO source such as the MAX2620 is available, AC couple the inverting output into TANK.

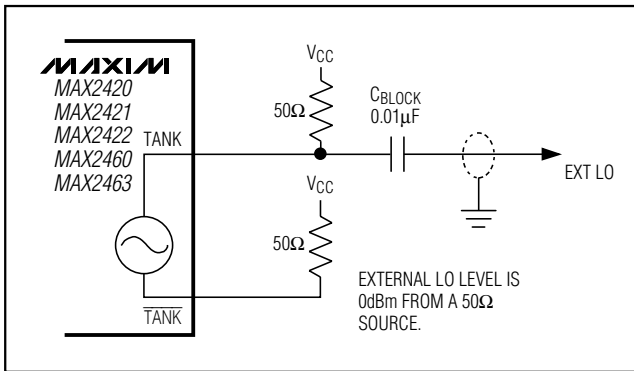

Figure 3. Using an External Local Oscillator

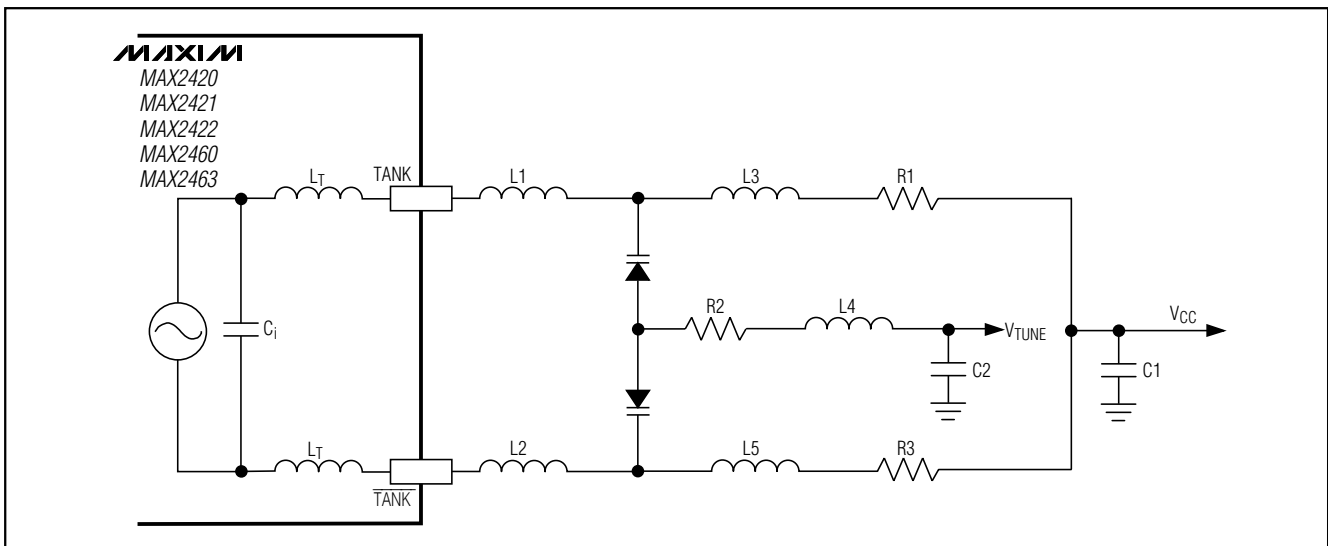
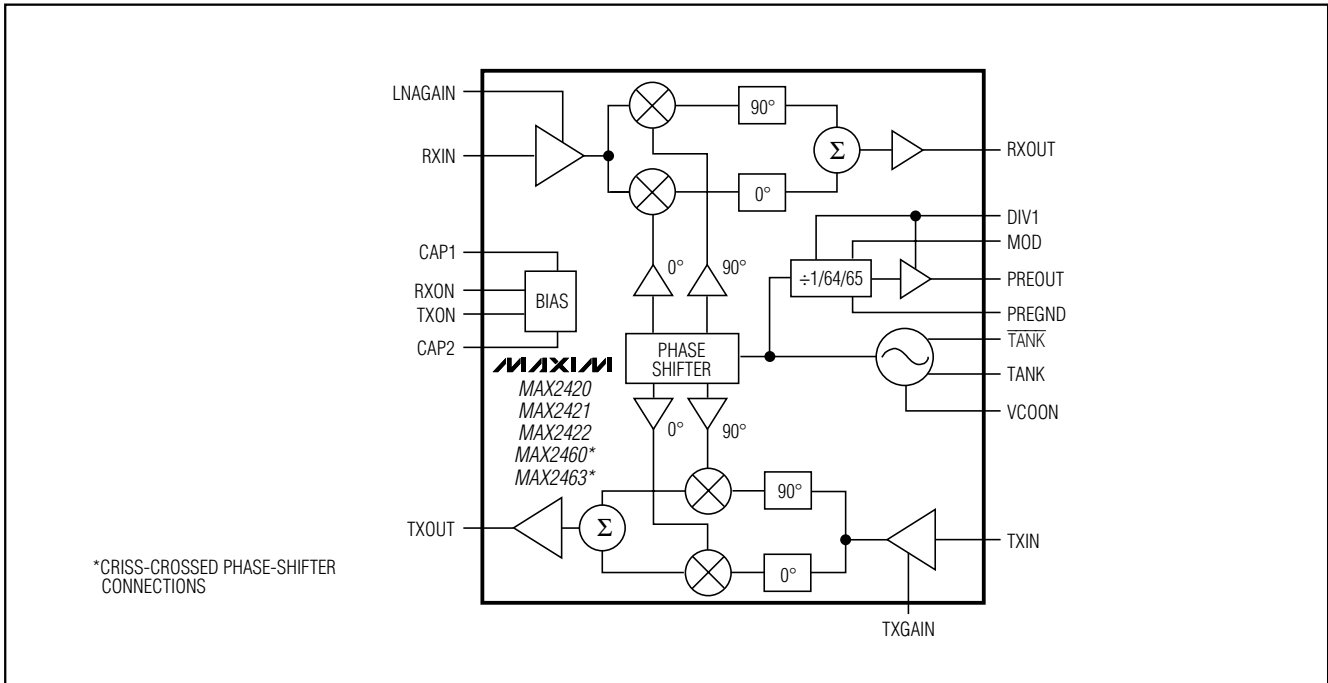

Figure 4. Series Coupled Resonant Tank for Wide Tuning Range and Low Phase Noise

# 900MHz Image-Reject Transceivers

## Functional Diagram



MAX2420/MAX2421/MAX2422/MAX2460/MAX2463

# 900MHz Image-Reject Transceivers

## Package Information

(The package drawing(s) in this data sheet may not reflect the most current specifications. For the latest package outline information, go to [www.maxim-ic.com/packages](http://www.maxim-ic.com/packages).)

DIM	INCHES		MILLIMETERS	
	MIN	MAX	MIN	MAX
A	0.068	0.078	1.73	1.99
A1	0.002	0.008	0.05	0.21
B	0.010	0.015	0.25	0.38
C	0.004	0.008	0.09	0.20
D	SEE VARIATIONS			
E	0.205	0.212	5.20	5.38
e	0.0256 BSC		0.65 BSC	
H	0.301	0.311	7.65	7.90
L	0.025	0.037	0.63	0.95
$\alpha$	0 $^{\circ}$	8 $^{\circ}$	0 $^{\circ}$	8 $^{\circ}$

D	INCHES		MILLIMETERS		N
	MIN	MAX	MIN	MAX	
D	0.239	0.249	6.07	6.33	14L
D	0.239	0.249	6.07	6.33	16L
D	0.278	0.289	7.07	7.33	20L
D	0.317	0.328	8.07	8.33	24L
D	0.397	0.407	10.07	10.33	28L

NOTES:

1. D&E DO NOT INCLUDE MOLD FLASH.
2. MOLD FLASH OR PROTRUSIONS NOT TO EXCEED .15 MM (.006").
3. CONTROLLING DIMENSION: MILLIMETERS.
4. MEETS JEDEC MO150.
5. LEADS TO BE COPLANAR WITHIN 0.10 MM.

<small>PROPRIETARY INFORMATION</small>	
<small>TITLE:</small> PACKAGE OUTLINE, SSOP, 5.3 MM	
<small>APPROVAL</small>	<small>DOCUMENT CONTROL NO.</small> 21-0056
<small>REV.</small> C	<small>REV.</small> 1/1

SSOP.EPS

Maxim cannot assume responsibility for use of any circuitry other than circuitry entirely embodied in a Maxim product. No circuit patent licenses are implied. Maxim reserves the right to change the circuitry and specifications without notice at any time.

Maxim Integrated Products, 120 San Gabriel Drive, Sunnyvale, CA 94086 408-737-7600 \_\_\_\_\_ 14

# Mouser Electronics

Authorized Distributor

Click to View Pricing, Inventory, Delivery & Lifecycle Information:

## Maxim Integrated:

[MAX2420EAI+](#) [MAX2420EAI+T](#) [MAX2421EAI+](#) [MAX2421EAI+T](#) [MAX2422EAI+](#) [MAX2422EAI+T](#) [MAX2460EAI+](#)  
[MAX2460EAI+T](#) [MAX2463EAI+](#) [MAX2463EAI+T](#) [MAX2420EAI](#) [MAX2420EAI-T](#) [MAX2421EAI](#) [MAX2421EAI-T](#)  
[MAX2422EAI](#) [MAX2422EAI-T](#) [MAX2460EAI](#) [MAX2460EAI-T](#) [MAX2463EAI](#) [MAX2463EAI-T](#)