

Absolute Maximum Ratings

V_{DD} to GND-0.3V to +6.0V
 SCL, SDA, $\overline{\text{ALERT}}$, FF/FS, $\overline{\text{SHDN}}$,
 TACH1, TACH2 and PWM to GND-0.5V to +6.0V
 DXP, DXN, A0, A1, and A2 to GND.....-0.3V to (V_{DD} + 0.3V),
 not to exceed +6.0V
 SCL, SDA, $\overline{\text{ALERT}}$, FF/FS, $\overline{\text{SHDN}}$, PWM Current.....8mA
 DXN Current.....200 μ A

Continuous Power Dissipation (T_A = +70°C)
 QSOP (derate 9.6mW/°C above +70°C)771.5mW
 ESD Protection (All Pins, Human Body Model) \pm 2kV
 Operating Temperature Range..... -40°C to +125°C
 Junction Temperature..... +150°C
 Storage Temperature Range -65°C to +150°C
 Lead Temperature (soldering, 10s)+300°C
 Soldering Temperature (reflow).....+260°C

Stresses beyond those listed under “Absolute Maximum Ratings” may cause permanent damage to the device. These are stress ratings only, and functional operation of the device at these or any other conditions beyond those indicated in the operational sections of the specifications is not implied. Exposure to absolute maximum rating conditions for extended periods may affect device reliability.

Package Thermal Characteristics (Note 1)

QSOP
 Junction-to-Ambient Thermal Resistance (θ_{JA})103.7°C/W
 Junction-to-Case Thermal Resistance (θ_{JC}).....37°C/W

Note 1: Package thermal resistances were obtained using the method described in JEDEC specification JESD51-7, using a four-layer board. For detailed information on package thermal considerations, refer to www.maximintegrated.com/thermal-tutorial.

Recommended DC Operating Conditions

(T_A = -40°C to +125°C, unless otherwise noted.) (Note 2)

PARAMETER	SYMBOL	CONDITIONS	MIN	TYP	MAX	UNITS
V _{DD} Voltage	V _{DD}	(Note 3)	3.0	3.3	3.6	V
Input Logic 0 (SDA, SCL)	V _{IL}		-0.3		+0.8	V
Input Logic 0 (All Other Inputs)			-0.3		V _{DD} x 0.3	
Input Logic 1 (SDA, SCL)	V _{IH}		2.1		V _{DD} + 0.3	V
Input Logic 1 (All Other Inputs)			V _{DD} x 0.7		V _{DD} + 0.3	

Electrical Characteristics

(3.0V ≤ V_{DD} ≤ 3.6V, T_A = -40°C to +125°C, unless otherwise noted.)

PARAMETER	SYMBOL	CONDITIONS	MIN	TYP	MAX	UNITS
Supply Current	I _{DD}	Normal operation		2.6	4	mA
	I _{STB}	Standby mode		2	3	mA
Internal Temperature Measurement Resolution		T _A = -40°C to +125°C		0.125		°C
External Temperature Measurement Resolution		T _A = -40°C to +125°C		0.125		°C
Conversion Time	t _{CONV}	Both internal and external channels			150	ms

Electrical Characteristics (continued)(3.0V ≤ V_{DD} ≤ 3.6V, T_A = -40°C to +125°C, unless otherwise noted.)

PARAMETER	SYMBOL	CONDITIONS		MIN	TYP	MAX	UNITS
Remote Diode Source Currents		High level	Not production tested	150		10	μA
		Low level					
Open-Drain Output Saturation Voltage (ALERT, FF/FS, SHDN, PWM, SDA)	V _{SAT}	I _{OUT} = 4mA		0.4			V
PWM Clock High Frequency	f _{PWMH}			6.4			MHz
PWM Clock High Frequency Accuracy				-7		+7	%
PWM Clock Low Frequency	f _{PWML}			8.3			kHz
PWM Clock Low Frequency Accuracy				-7		+7	%
PWM Output High Frequency				25			kHz
PWM Output High Frequency Accuracy				-7		+7	%
PWM Output Low Frequency				33			Hz
PWM Output Low Frequency Accuracy				-7		+7	%
Fan Counter Clock Frequency	f _{FANC}			100			kHz
Fan Counter Clock Frequency Accuracy				-7		+7	%
Fan Full-Scale Count	N _F			65,535			
TACH_ Pulse Counting Accuracy				-7		+7	%
EEPROM Write Time	t _W	(Note 4)		550			ms
EEPROM Write Cycles		T _A = +85°C (Note 5)		1000			

Temperature-Sensing Error(3.0V ≤ V_{DD} ≤ 3.6V, unless otherwise noted.)

PARAMETER	SYMBOL	CONDITIONS	MIN	TYP	MAX	UNITS
Internal Temperature Measurement Error		T _A = 0°C to +70°C	-2		+2	°C
		T _A = -40°C to +85°C	-3		+3	°C
		T _A = -40°C to +125°C	-4		+4	°C
External Temperature Measurement Error		T _A = 0°C to +85°C, T _D = -40°C to +125°C	-2		+2	°C
		T _A = -40°C to +125°C, T _D = -40°C to +100°C	-3		+3	°C
		T _A = -40°C to +125°C, T _D = -40°C to +125°C	-4		+4	°C

I²C AC ELECTRICAL CHARACTERISTICS(3.0V ≤ V_{DD} ≤ 3.6V, T_A = -40°C to +125°C, unless otherwise noted.) (Figure 1)

PARAMETER	SYMBOL	CONDITIONS	MIN	TYP	MAX	UNITS
SCL Clock Frequency	f _{SCL}	(Note 6)	0.5		400	kHz
Bus Free Time Between STOP and START Conditions	t _{BUF}		1.3			μs
Hold Time (Repeated) START Condition	t _{HD:STA}		0.6			μs
Low Period of SCL	t _{LOW}		1.3			μs
High Period of SCL	t _{HIGH}		0.6			μs
Data Hold Time	t _{HD:DAT}		0		0.9	μs
Data Setup Time	t _{SU:DAT}		100			ns
START Setup Time	t _{SU:STA}		0.6			μs
SDA and SCL Rise Time	t _R	(Note 7)	20 + 0.1C _B		300	ns
SDA and SCL Fall Time	t _F	(Note 7)	20 + 0.1C _B		300	ns
STOP Setup Time	t _{SU:STO}		0.6			μs
SDA and SCL Capacitive Loading	C _B	(Note 7)			400	pF
Pulse Width of Spike Suppressed	t _{SP}				50	ns
Interface Reset Time	t _{TIMEOUT}	SDA time low (Note 8)	25		45	ms

Note 2: Limits are 100% production tested at T_A = +25°C and T_A = +85°C. Limits over the operating temperature range and relevant supply voltage range are guaranteed by design and characterization. Typical values are not guaranteed..

Note 3: All voltages are referenced to GND.

Note 4: EEPROM write time, t_W, applies to writing all 80 bytes of nonvolatile memory (00h through 4Fh). The time to write each 16-byte block of data is typically 110ms. See the EEPROM LOAD/WRITE register (EEX), register 5Bh for memory block assignments. EEPROM writes begin after a STOP condition occurs.

Note 5: Guaranteed by design.

Note 6: I²C interface timing shown is for fast mode (400kHz) operation. This device is also backward compatible with I²C standard-mode timing.

Note 7: C_B = total capacitance of one bus line in pF. The maximum bus capacitance allowable can vary from this value depending on the actual operating voltage and frequency of the application.

Note 8: The timeout applies only when the MAX31760 is holding SDA low. Other devices can hold SDA low indefinitely and the MAX31760 does not reset the bus.

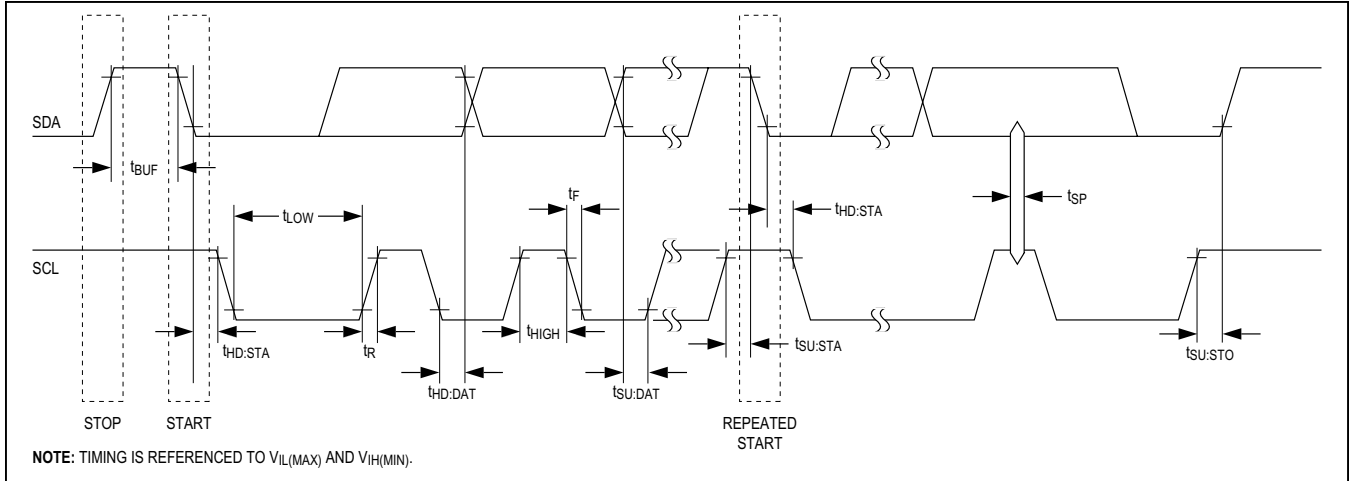
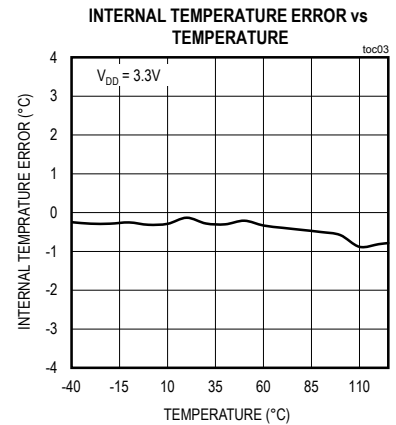
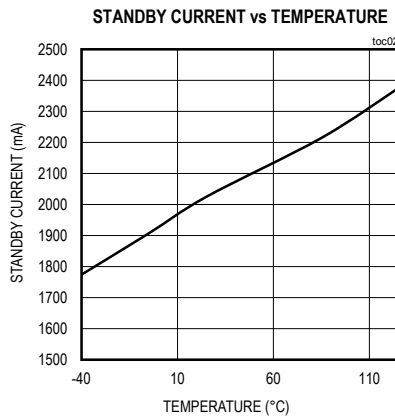
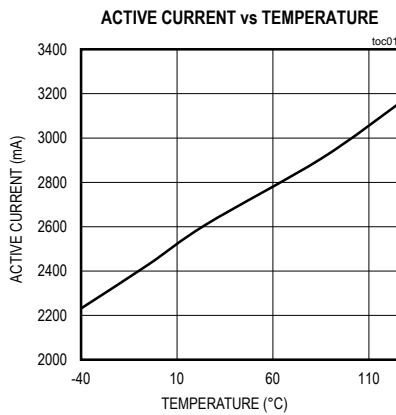

Figure 1. I²C Timing Diagram

Typical Operating Characteristics

(3.0V ≤ V_{DD} ≤ 3.6V, unless otherwise noted.)



Pin Configuration

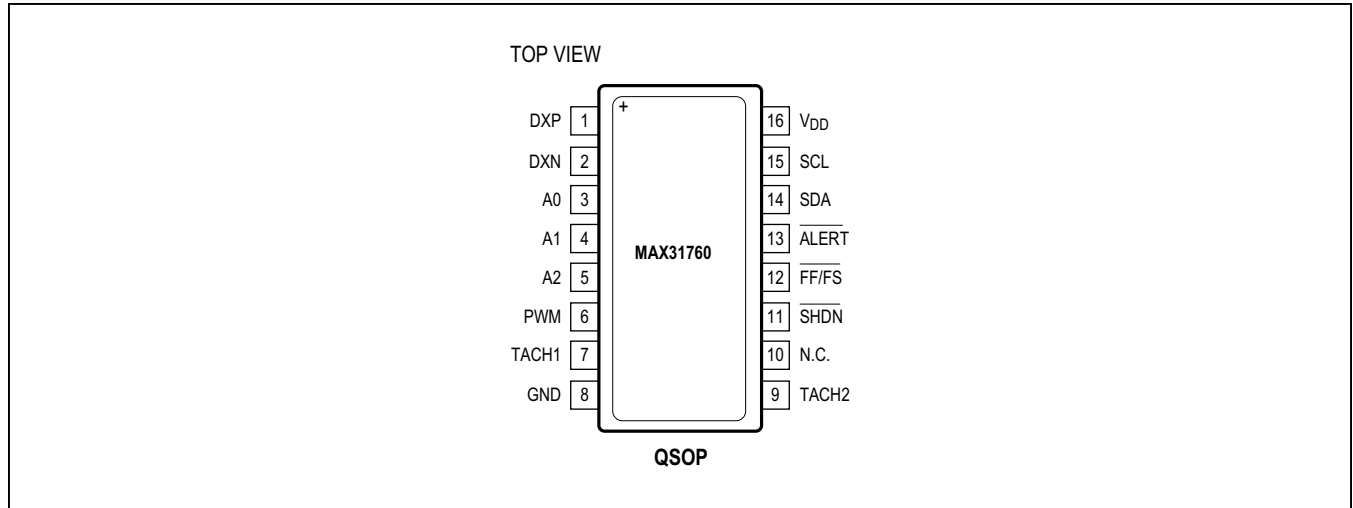

Pin Description

PIN	NAME	FUNCTION
1	DXP	Analog Current Output/Voltage Input. Connect to the anode of the remote diode.
2	DXN	Analog Input. Connect to the cathode of the remote diode. Do not connect to ground.
3	A0	Address Select Input. Determines I ² C slave address. Must be connected to V _{DD} or GND.
4	A1	
5	A2	
6	PWM	PWM Output. Open-drain output for fan drive. The power-on default for this pin is high impedance.
7	TACH1	Tachometer Input 1. Logic input for measuring speed of fan 1.
8	GND	Ground Connection
9	TACH2	Tachometer Input 2. Logic input for measuring speed of fan 2.
10	N.C.	No Connection. Not internally connected.
11	SHDN	Active-Low Shutdown Output. Open-drain output for system shutdown when overtemperature is detected. Requires a pullup resistor. High impedance when V _{DD} = 0V.
12	FF/FS	Active-Low Fan-Failure Output and Full-Speed Input (Open Drain). The device pulls this output low if a fan failure is detected. The fan is forced to run full speed if this pin is pulled low externally. A pullup resistor to V _{DD} is recommended.
13	ALERT	Active-Low Alert Output. Open-drain fault output. ALERT is triggered when a measured temperature exceeds its programmed high limit. A pullup resistor to V _{DD} is recommended.
14	SDA	Serial Data Input/Output. Input/Output for I ² C data.
15	SCL	Serial Clock Input. Input for I ² C clock.
16	V _{DD}	Power-Supply Input. 3.0V to 3.6V voltage supply.

Block Diagram

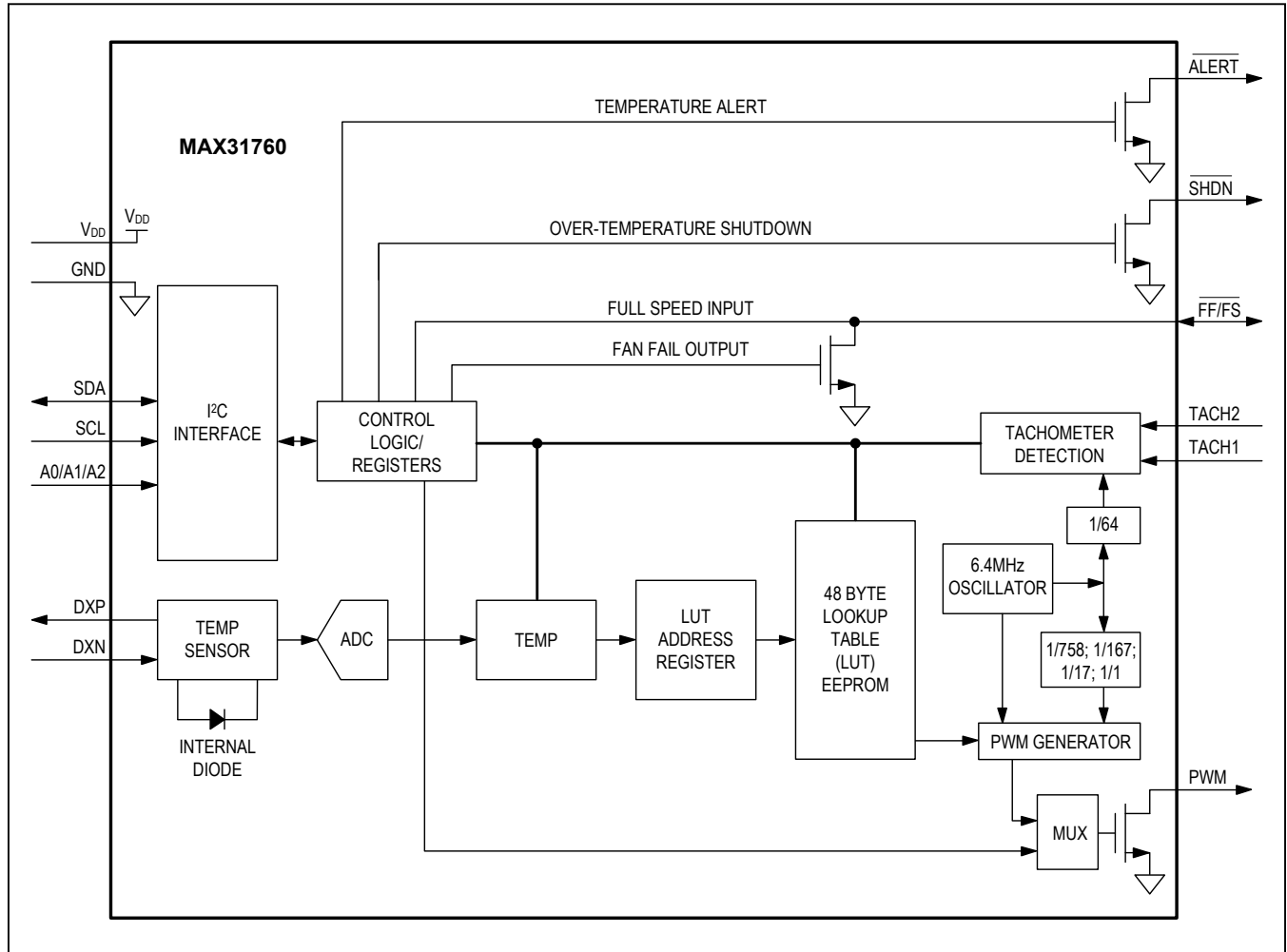

Detailed Description

The MAX31760 is a precision lookup table (LUT)-based PWM fan controller. The device accurately measures its internal die temperature and the temperature of an external diode-connected transistor, which can be a discrete small-signal device like a 2N3906 or a thermal diode on the die of a CPU, graphics processor unit (GPU), or other ASIC. Fan speed is controlled based on the temperature reading as an index to a 48-byte nonvolatile LUT containing user-programmed PWM values. The temperature reading that is used as an index to the LUT can be either the local value, the remote value, or the greater of these two. The PWM values selected from the LUT determine the duty cycle of the PWM, which can be used to drive 4-wire, 3-wire, or 2-wire fans. The flexible LUT-based architecture enables the user to program a smooth nonlinear fan speed

vs. temperature transfer function often desired to minimize acoustic fan noise. All fan-control profile and configuration settings can be stored in nonvolatile memory that loads into operating memory at power-up or on request, allowing automatic, independent fan speed control.

In addition to using temperature measurements to determine PWM duty cycle, the device also features multiple temperature thresholds for thermal protection. The temperature thresholds include local high set point (LHS), local overtemperature set point (LOTS), remote high set point (RHS), and remote overtemperature set point (ROTS). These thresholds are programmable through the I2C-compatible interface. ALERT is pulled low to indicate a temperature fault state if the local temperature exceeds the LHS or remote temperature exceeds the RHS.

If LOTS or ROTS is surpassed, $\overline{\text{SHDN}}$ is pulled low to shut down the system in order to avoid thermal damage.

The device has two TACH input pins, TACH1 and TACH2, that can accept the tachometer outputs from two 4-wire or 3-wire fans, thereby allowing them to monitor RPM and detect faults for both fans. If the fans generate “locked rotor” or “rotation detector” (RD) signals rather than tachometer pulses, TACH1 and TACH2 can be configured to read the RD signals and detect whether a fan has stopped rotating. Based on the inputs at the TACH pins, the device can detect if a fan fault has occurred. If a fan fault is detected, FF/FS is pulled low and the PWM duty cycle is forced to the value selected in the FFDC register (03h).

Temperature Sensing

An internal temperature sensor measures the die (local) temperature. The device also measures the temperature of a remote diode-connected transistor. The resolution is 0.125°C for both local and remote temperature sensing. Each temperature reading is represented by an 11-bit, two’s complement word that contains 10 bits of magnitude data and one sign bit. The value of the least significant bit (LSB), bit 5, is 0.125°C. The temperature data format is left-aligned with the sign at bit 15. [Table 1](#) and [Table 2](#) shows the temperature data register format.

The remote temperature reading is stored in the remote temperature registers, with the MSB portion in the high Remote Temperature Reading register (RTH) and the

LSB portion in the low Remote Temperature Reading register (RTL). The local temperature reading is stored in the local temperature registers, with the MSB portion in the high Local Temperature Reading register (LTH) and the LSB portion in the low Local Temperature Reading register (LTL).

Temperature-Sensing Diode Ideality Factor Correction

The diode ideality factor, n_d , plays an important role in the measurement of temperature in an external diode-connected transistor (or thermal diode). The value of n_d is process-dependent and varies between devices. If the temperature measurement algorithm assumes the temperature-sensing diode’s ideality factor is n_{ASSUMED} but the actual value is n_{REAL} , an error is incurred by this ideality factor mismatch:

$$T_{\text{ERROR}} = T_{\text{MEASURED}} - T_{\text{REAL}} = (n_{\text{REAL}}/n_{\text{ASSUMED}} - 1) \times T_{\text{REAL}}$$

To use an ideality factor close to the actual value, the device provides an ideality factor LUT. There are 64 pre-selected ideality factors in the table. Select the ideality factor value to be used in temperature sensing by setting the Ideality Factor register (IFR) to the value closest to the actual ideality of the sensing diode to be used. [Table 3](#) shows the IFR bitmap and [Table 4](#) shows the ideality factor LUT. The device’s factory-programmed default ideality factor is 1.008 (position 18h).

Table 1. Temperature Data Format

TEMPERATURE DATA FORMAT: REMOTE AND LOCAL (°C)															
HIGH REGISTER BITS								LOW REGISTER BITS							
15	14	13	12	11	10	9	8	7	6	5	4	3	2	1	0
Sign	64	32	16	8	4	2	1	0.5	0.25	0.125	0	0	0	0	0

Table 2. Temperature Reading Examples

TEMPERATURE (°C)	REGISTER VALUES IN BINARY		REGISTER VALUES IN HEX	
	HIGH REGISTER	LOW REGISTER	HIGH REGISTER	LOW REGISTER
+125	0111 1101	0000 0000	7Dh	00h
+85	0101 0101	0000 0000	55h	00h
+25	0001 1001	0000 0000	19h	00h
+1	0000 0001	0000 0000	01h	00h
+0.125	0000 0000	0010 0000	00h	20h
0	0000 0000	0000 0000	00h	00h
-0.125	1111 1111	1110 0000	FFh	E0h
-1	1111 1111	0000 0000	FFh	00h
-25	1110 0111	0000 0000	E7h	00h
-55	1100 1001	0000 0000	C9h	00h

Table 3. Ideality Factor Register (IFR)

ADDRESS	BIT 7	BIT 6	BIT 5	BIT 4	BIT 3	BIT 2	BIT 1	BIT 0
05h	0	0	IF5	IF4	IF3	IF2	IF1	IF0

Table 4. Transistor Ideality Register

SELECTION (HEX)	IDEALITY FACTOR	SELECTION (HEX)	IDEALITY FACTOR	SELECTION (HEX)	IDEALITY FACTOR
0x00	0.9844	0x16	1.0060	0x2C	1.0286
0x01	0.9853	0x17	1.0070	0x2D	1.0296
0x02	0.9863	0x18	1.0080	0x2E	1.0307
0x03	0.9873	0x19	1.0090	0x2F	1.0317
0x04	0.9882	0x1A	1.0100	0x30	1.0328
0x05	0.9892	0x1B	1.0110	0x31	1.0338
0x06	0.9902	0x1C	1.0120	0x32	1.0349
0x07	0.9911	0x1D	1.0130	0x33	1.0360
0x08	0.9921	0x1E	1.0141	0x34	1.0370
0x09	0.9931	0x1F	1.0151	0x35	1.0381
0x0A	0.9941	0x20	1.0161	0x36	1.0392
0x0B	0.9950	0x21	1.0171	0x37	1.0402
0x0C	0.9960	0x22	1.0182	0x38	1.0413
0x0D	0.9970	0x23	1.0192	0x39	1.0424
0x0E	0.9980	0x24	1.0202	0x3A	1.0435
0x0F	0.9990	0x25	1.0213	0x3B	1.0445
0x10	1.0000	0x26	1.0223	0x3C	1.0456
0x11	1.0010	0x27	1.0233	0x3D	1.0467
0x12	1.0020	0x28	1.0244	0x3E	1.0478
0x13	1.0030	0x29	1.0254	0x3F	1.0489
0x14	1.0040	0x2A	1.0265	≥0x40	Not Valid
0x15	1.0050	0x2B	1.0275	—	—

Table 5. Temperature Threshold Registers

TEMPERATURE THRESHOLDS	REGISTERS	
	HIGH BYTE (MSB)	LOW BYTE (LSB)
Local High Set Point (LHS)	LHSH (0Ch)	LHSL (0Dh)
Remote High Set Point (RHS)	RHSH (06h)	RHSL (07h)
Local Overtemperature Set Point (LOTS)	LOTSH (08h)	LOTSL (09h)
Remote Overtemperature Set Point (ROTS)	ROTSH (0Ah)	ROTSL (0Bh)

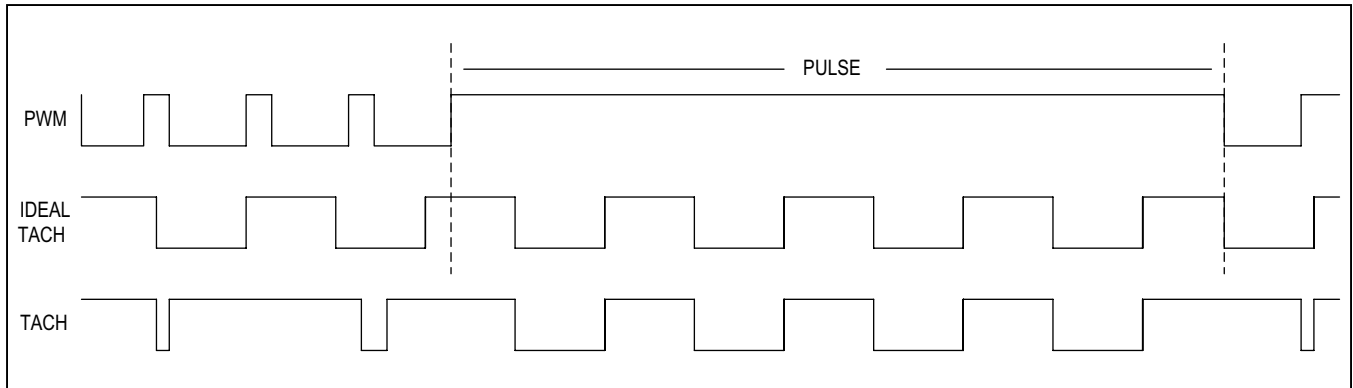

Figure 3. Pulse Stretching to Process TACH Information

modulated by the PWM signal. During the “off” period of the waveform, there is no TACH signal. If the “on” period is sufficiently long (relative to the TACH period) so that four TACH periods are available, then fan speed can be measured and fan failure can be detected. If the “on” period is too short, a full TACH period may not be available, which prevents the fan’s speed from being measured. One approach to measuring fan speed when the nominal “on” period is too short (or the TACH periods are too long) is to insert a PWM pulse with extended on-time (pulse stretching) to measure four full tachometer periods. When pulse stretching is enabled and PWM polarity is positive (as selected by CR1.2), PWM will remain high until four TACH pulses have been counted. Figure 3 illustrates the idea of pulse stretching. If a full count is reached before counting four pulses, PWM will go low. (Note that if the PWM polarity is negative the stretched pulse will be low.) If fewer than 4 TACH periods are available, the stretched PWM pulse will have a nominal width equal to a full count of $(65535 \times 4)/100\text{kHz} = 2.62\text{s}$.

Note that while pulse stretching is enabled, the fan fault detection will take place during “normal” PWM pulses (between the stretched pulses) as well, but to avoid invalid fault detections, a fault will be detected only when 4 TACH periods have been counted.

The PSEN bit (pulse stretch enable: CR3.2) enables pulse stretching. When enabled, a stretched pulse will occur approximately every 12s. Note that pulse stretching

can be enabled only when the PWM frequency is 33Hz (DRV = 00) and when TACHFULL = 0. If DRV≠0 or if TACHFUL = 1, the PSEN bit is ignored and pulse stretching is disabled.

If DRV is 00 and PSEN is 0, there is no pulse stretching. Under this condition, the TACH measurements are valid if PWM is sufficiently wide to allow 4 TACH pulses. This will typically be the case only with higher speed fans (e.g. 10,000RPM or greater).

Another alternative to pulse stretching is to use the TACHFULL bit. If TACHFULL (CR3.3) is set to 1, TACH measurements will be valid only when the PWM duty cycle is 100%; if the duty cycle is not 100% fan fault detection is disabled. Fan fault detection in this mode will therefore be active only part of the time (when the duty cycle is 100%), so the detection of fan faults may be relatively infrequent.

When DRV is 00, TACHFULL is 0, and PSEN is 1, pulse stretching is enabled immediately after PSEN is set to 1. The next pulse is stretched to allow the device to obtain an accurate tachometer reading and update the TACH count register. Once the TACHx count register has been updated, normal PWM pulse output resumes. If PSEN is kept as 1, a stretched pulse is inserted into PWM pulse train once every 12s to avoid excessive audible noise. If a system only needs a TACH reading infrequently, the host can set PSEN to 1 when it needs the TACH update. After that, the host can clear PSEN to 0 and thus disable the

Table 6. Temperature Index Source

MTI (CR1.1)	TIS (CR1.0)	TEMPERATURE INDEX SOURCE
0	0	Local temperature is used as the index.
0	1	Remote temperature is used as the index (factory default setting).
1	X	The maximum of the local temperature and the remote temperature is used as the index.

Table 7. 48-Step I²C Programmable LUT Map

REGISTER	NAME	ADDRESS (HEX)
LUT0	PWM value for T < +18°C	20h
LUT1	PWM value for +18°C ≤ T < +20°C	21h
LUT2	PWM value for +20°C ≤ T < +22°C	22h
...
LUT45	PWM value for +106°C ≤ T < +108°C	4Dh
LUT46	PWM value for +108°C ≤ T < +110°C	4Eh
LUT47	PWM value for T ≥ +110°C	4Fh

pulse stretching. Doing so helps to minimize the audible noise introduced by pulse stretching.

When the PWM frequency is 33Hz and the duty cycle is 0% or decreasing toward 0%, then fan fault detection is disabled. Also, when the PWM frequency is 33Hz, the FF_0 bit functionality (CR3.6) is not valid.

Variable DC Control

Because pulse stretching can cause the fan to speed up in response to the longer pulse, this further increases the audible noise level associated with PWM of the power supply. In contrast, the variable DC drive approach keeps the fan continuously on, so the tachometer signal is not altered. One such approach, using either a linear or a switching regulator, is shown in [Figure 2c](#).

PWM Polarity

Set the active level of the PWM output using the PPS bit (PWM polarity: CR1.2). When PPS is 0, a 100% PWM output is high. When PPS is 1, a 100% PWM output is low.

Automatic Fan-Speed Control Based on LUT

The device uses a 48-byte LUT to map the measured temperature to a desired PWM duty cycle that controls fan speed. The local temperature, the remote temperature, or the larger of the two can be used as an index to the LUT. Control bits TIS (temperature index source: CR1.0) and MTI (maximum temperature as index: CR1.1) determine the source of the index. [Table 6](#) shows the control bit values and the corresponding temperature source.

The factory-programmed default value is 1 for the TIS bit and 0 for the MTI bit. The PWM duty-cycle values in the

LUT are programmable through the I²C-compatible interface. [Table 7](#) shows the 48-byte LUT.

LUT Hysteresis

The device provides a programmable hysteresis for the LUT to prevent the duty cycle from alternating between two values if the measured temperature falls on the boundary between two windows. [Figure 4](#) illustrates the LUT hysteresis, and [Table 8](#) shows the HYST (LUT hysteresis: CR1.5) control bit function.

Setting PWM Frequency and Duty Cycle

In most 4-wire fan applications, set the PWM frequency to 25kHz as recommended by most fan manufacturers (150Hz and 1500Hz PWM frequencies are also available for fans that require them.) An internal 6.4MHz PWM clock generates PWM pulses. The PWM duty-cycle resolution is 1/256, so any available duty cycle can be represented by an 8-bit value in either a PWM duty-cycle register in the LUT, or the Direct Duty-Cycle Control register (PWMR) in memory location 50h.

$$\text{PWM_Resolution} = 1/256$$

$$\text{PWM_Duty_Cycle} = \text{PWM_Resolution} \times \text{PWM_Register_Value} \times 100$$

[Table 9](#) shows a few examples of register values and the corresponding duty cycles.

For 1500Hz, 150Hz, or 33Hz PWM, the PWM clock frequency is divided by 17, 167, or 758 to yield the correct PWM frequency while maintaining 8-bit duty cycle resolution. [Table 10](#) summarizes common fan types and driving approaches.

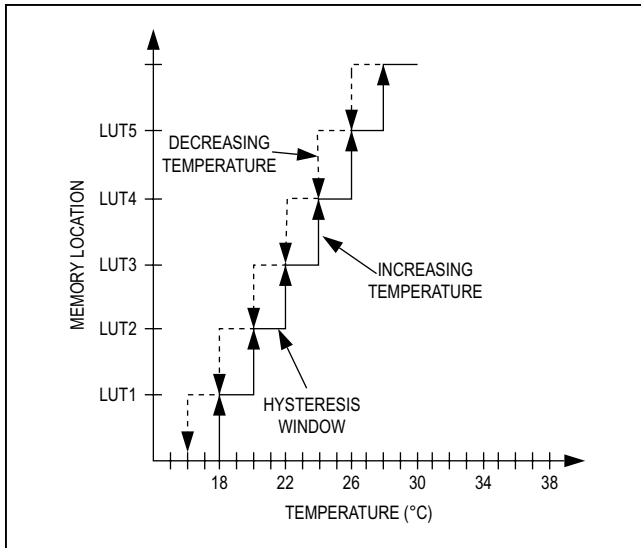

Figure 4. LUT Hysteresis; HYST Bit (CR1.5) = 0

Table 8. HYST Bit Hysteresis

HYST (CR1.5)	HYSTERESIS (°C)
0	2
1	4

Table 9. PWM Duty Cycle and Register Value (PWMR, Register 50h)

REGISTER VALUE (HEX)	PWM DUTY CYCLE (%)
00h	0.00
01h	0.39
02h	0.78
...	...
FDh	98.83
FEh	99.22
FFh	Forced to 100.00

Table 10. Fan Type and Driving Modes

FAN CONTROL METHOD	PWM FREQUENCY	PWM CLOCK FREQUENCY	DUTY-CYCLE RESOLUTION	FAN SUPPLY VOLTAGE	TACHOMETER SIGNAL	CONTROL BITS
4-wire fan	25kHz, 1.5kHz, 150Hz	6.4MHz, 376.47kHz, 38.32kHz	1/256	Constant magnitude	Standard	DRV = 01, 10, or 11, PSEN = don't care TACHFULL=0
3-wire fan driven by variable DC supply	25kHz	6.4MHz	1/256	Variable magnitude	Standard as long as the fan supply voltage is greater than the minimum value for the fan's internal circuitry.	DRV = 11, PSEN = don't care TACHFULL=0
3-wire fan driven by supply modulation (pulse stretching enabled)	33Hz	8.3kHz	1/256	Pulse-width modulated (can create audible noise)	Modulated by PWM. Measured during periodic stretched PWM pulses. Stretched pulses may cause audible artifacts with some fans.	DRV = 00, PSEN = 1 TACHFULL=0
3-wire fan driven by supply modulation (pulse stretching disabled)	33Hz	8.3kHz	1/256	Pulse-width modulated	Modulated by PWM. Measured only when duty cycle is 100%.	DRV = 00, PSEN = 0 TACHFULL=1

Direct (“Manual”) Fan-Speed Control

If desired, the LUT can be overridden and the master can control the fan speed directly by writing a PWM duty-cycle value to PWMR (Register 50h). [Table 9](#) shows the relationship between the value written to PWMR and the PWM duty cycle.

To activate direct fan-speed control (thus disabling the LUT functionality), set control bit DFC (direct fan control, CR2.0) to 1. Then write the desired PWM duty-cycle value to the PWMR register. Clearing control bit DFC disables direct fan-speed control, and the LUT is automatically selected to control the fan speed based on the measured temperature value(s).

PWM Duty-Cycle Ramp Rate

To ensure minimal audibility of fan-speed variations as temperature and PWM duty cycles change, the device changes the output PWM duty cycle at a selectable rate (determined by the RAMP0 and RAMP1 bits in Control Register 3) to minimize the rate at which the fan’s acoustic noise increases and decreases ([Table 11](#)). This ramp rate applies for both LUT-based fan-speed control and direct fan-speed control.

The PWM duty cycle always ramps toward the latest target value determined by the LUT. For example, if the temperature rises to +30°C, the duty cycle begins ramping toward the value corresponding to +30°C in the LUT (D30). If the temperature drops to +24°C before duty cycle D30 has been reached, the target duty cycle is now D24, and the duty cycle begins moving toward D24 (the

duty-cycle setting corresponding to the LUT register for +24°C).

During the ramp-up process, the actual output PWM duty cycle is not same as the target value. The PWMV register stores the current value of the PWM duty-cycle setting. Read PWMV (Register 51h) to obtain the current PWM duty cycle.

Fan Spin-Up

Some fans cannot reliably start spinning from a stopped condition unless driven with close to 100% duty cycle (or supply voltage, in the case of 3-wire fans). To overcome this problem, an optional fan spin-up function can be enabled to start the fan reliably. Spin-up overcomes the fan’s inertia by providing it with 100% drive for a short time. If spin-up is enabled, changing the selected duty cycle from zero to a nonzero value causes the PWM duty cycle to immediately go to 100% until one of the following conditions is met, whichever comes sooner:

- A 2s timeout has passed, or
- Two tachometer pulses are detected at each enabled TACH input

After the spin-up period is over, the PWM duty cycle reverts to the value determined by the LUT or the value in the PWMR register, depending on the status of the DFC bit (direct fan control: CR2.0). If spin-up is disabled, the PWM duty cycle is always determined by the output of the LUT or the direct fan control register, depending on the state of the DFC bit. Enable fan spin-up by setting the SPEN bit (spin-up enable: CR2.5) to 1.

Table 11. PWM Duty-Cycle Ramp Rates

RAMP1	RAMP0	PWM ADJUST RAMP RATE SELECT	PWM DUTY-CYCLE CHANGE ALLOWED PER SECOND (%)
0	0	Slow (default)	3.125
0	1	Slow-Medium	6.25
1	0	Medium-Fast	12.5
1	1	Fast	Immediate

Tachometer Inputs

The device has two TACH input pins, TACH1 and TACH2, that accept the tachometer signals from two fans independently. Tachometer signals are typically open drain so external pullup resistors are needed for the TACH1 and TACH2 pins. TACH1, TACH2, or both can be disabled depending on the number of fans that need to be monitored. The tachometer enable bits, TACH1E (CR3.0) and TACH2E (CR3.1), control the enabling/disabling of TACH1 and TACH2, respectively. To enable a fan-monitoring input, set the enable/disable bit for that input to 1. Both TACH inputs are factory programmed to default enabled.

The speed of each fan can be determined using the contents of the TACH count registers. There is an internal fan-counter clock running at 100kHz. To cancel out the effect of the mechanical tolerance, the device counts the number of fan-counter clock periods over four tachometer pulses. The resulting average tachometer pulse count is stored in a 2-byte TACH count register. [Table 12](#) shows the register definitions.

If the decimal value in TCxH is {TCxH} and the decimal value in TCxL is {TCxL}, where x = 1 or 2, the RPM of the fan can be calculated as:

$$\text{Fan_RPM} = 60 \times 100,000 / (\{TCxH\} \times 256 + \{TCxL\}) / n$$

where n is the number of pulses generated by the tachometer per revolution.

To detect fan failure, write a TACH count failure threshold value in the 2-byte TACH Count Threshold register (TCTH and TCTL). When the values in the TACH_Count register pairs are higher than the value in the threshold register pair, or when overflow occurs, the fan is considered as running at a speed lower than the threshold and the fan-fault error is indicated in the Status register and (if not masked) with the FF_FS output. During the first 2s of fan startup, fan-error detection is disabled, whether or not spin-up is enabled. After 2s, fan-error detection is enabled to ensure reliable fan monitoring. Fan-failure detection is disabled when the PWM duty cycle is zero or decreasing to zero.

Care must be taken when counting the tachometer output from a 3-wire fan driven by power-supply modulation. See the [PWM Fan-Speed Control](#) section for more information.

Some 3-wire fans provide a “rotation detection” (RD) or “locked rotor” signal that indicates whether or not the fan is running. When the FSST bit (fan-sense signal type: CR2.1) is set to 1, TACH1 and TACH2 are configured to accept RD signals instead of TACH signals. The polarity of the RD signal is selectable. If the RDPS bit (rotation-detection signal-polarity selection: CR2.2) is set to 1, the device interprets RD high, as indicating that the fan is spinning. If RDPS is cleared to 0, the device interprets RD low, as indicating that the fan is spinning. If the RD signal at either TACH1 or TACH2 indicates the fan is stalled, a fan-fault error is detected, except when bit 6 of CR3 is set to 0 and the PWM duty cycle is zero or is ramping down to a target value of zero.

When a fan-fault error is detected three times in a row (see the [Fault Queue](#) section for more information), FF/FS is asserted low and the PWM output duty cycle is forced to the value in register 03h. TACH signals are still monitored as long as a TACH input is enabled, and if the fan speed returns to the correct value, normal operation resumes .

Temperature Alert Output ($\overline{\text{ALERT}}$)

The device has an open-drain $\overline{\text{ALERT}}$ output to indicate that the measured temperature has extended beyond a temperature threshold. This output can be used as either a fault indicator or an interrupt output. In the fault indicator (comparator) mode, the $\overline{\text{ALERT}}$ asserts low when the local temperature exceeds LHS or the remote temperature exceeds RHS. When the temperature returns to the normal range, $\overline{\text{ALERT}}$ deasserts. A 1°C hysteresis is associated with the Local High and Remote High Alarms. To set the fault-indicator mode, set control bit ALERTS ($\overline{\text{ALERT}}$ functionality selection: CR2.6) to 1.

The $\overline{\text{ALERT}}$ output can also be configured as an interrupt output. In this mode, the output asserts low when the local temperature exceeds LHS or the remote temperature exceeds RHS. The $\overline{\text{ALERT}}$ output remains asserted until it is cleared, even if the error condition is no longer present. In this mode, reading the Status register (SR, memo-

Table 12. TACH Count Addresses

REGISTER	MSB	ADDRESS	LSB	ADDRESS
TACH1 Count (High/Low)	TC1H	52h	TC1L	53h
TACH2 Count (High/Low)	TC2H	54h	TC2L	55h

ry address 5Ah) sets the Alert Mask bit (ALTMSK - CR1.7) if LHA or RHA is set. This prevents further $\overline{\text{ALERT}}$ triggering until the master clears the condition at the end of the interrupt service routine by writing a 0 to the ALTMSK bit (CR1.7). LHA and RHA are cleared by a read command from the master, and are reasserted at the end of next conversion if the triggering condition persists. The control bit ALERTS (CR2.6) must be written to a 0 for $\overline{\text{ALERT}}$ to be used as an interrupt output. This is the default factory-programmed state. The following sequence describes the response of a system that uses the $\overline{\text{ALERT}}$ output pin as an interrupt flag:

- 1) Master senses $\overline{\text{ALERT}}$ low.
- 2) Master reads the device SR register to determine what caused the $\overline{\text{ALERT}}$.
- 3) The device clears LHA, RHA, LOTA, and ROTA, resets the $\overline{\text{ALERT}}$ output pin back to high impedance, and sets the Alert Mask bit (CR1.7) to 1, masking new faults from asserting $\overline{\text{ALERT}}$.
- 4) Master attends to conditions that caused $\overline{\text{ALERT}}$ to be triggered, for example, the fan is started, set point limits are adjusted, etc.
- 5) Master writes a 0 to the ALTMSK bit in CR1 to reset the interrupt.

Overtemperature Shutdown ($\overline{\text{SHDN}}$)

The $\overline{\text{SHDN}}$ pin is pulled low if the local temperature exceeds LOTS or the remote temperature exceeds ROTs. The LOTA bit (SR.4) is set to 1 if the local temperature exceeds LOTS. The ROTA bit (SR.2) is set to 1 if the remote temperature exceeds ROTs. $\overline{\text{SHDN}}$ can be used to prevent thermal damage by shutting down the system. A 10°C hysteresis is associated with the overtemperature detection. The ROTA bit is reset and the $\overline{\text{SHDN}}$ output deasserts (back to high impedance) when the remote temperature drops to or less than the ROTs value minus 10°C. The same hysteresis applies to local overtemperature detection. Reading the status register has no effect on either the $\overline{\text{SHDN}}$ output or the status bits ROTA and LOTA.

Fan-Fail Output and Full-Speed Input ($\overline{\text{FF/FS}}$)

$\overline{\text{FF/FS}}$ is a combination of fan-fail open-drain output and full-speed input. Two types of fan failure detection are supported, depending on the type of output signal available from the fan. If the fan has a tachometer output that produces pulses (typically 2 per revolution) as the fan spins, failure is determined by determining the rate of the TACH pulses. If the fan has a failure detection output (often called a “locked rotor” output), failure is determined

by detecting the state of this output. The type of failure detection is selected by the FSST bit (CR2.1).

Select FSST = 0 when the fan has a tachometer output. Most tachometer outputs provide two square-wave pulses per revolution. Fan speed is determined by counting the number of internal clock cycles that occur during four tachometer periods. To detect fan failure, write a TACH count failure threshold value in 2-byte TACH count Threshold register (TCTH and TCTL). When the values in the TACH_Count register pairs are higher than the value in the threshold register pair or when overflow occurs, the fan is considered as running at a speed lower than the threshold and a fan-fault error is generated. Three consecutive detections will cause the $\overline{\text{FF/FS}}$ output to assert.

Select FSST = 1 when the fan has a rotation detection (or “locked rotor”) output. If the fan’s rotation detection output is high when the fan is running, set the RDPS bit (CR2.2) to 1. Fan failure will cause the output to go low, driving the TACH input low and causing detection of a fan fault. Three consecutive detections of the low output will cause the $\overline{\text{FF/FS}}$ output to assert. If the fan’s rotation detection output is low when the fan is running, set the RDPS bit to 0, which will cause a fan fault to be detected when the TACH input is driven high.

For the fault output to be asserted for either signal type, the fault must occur for three consecutive times.

If the TACH alarms are not masked by bits 0:1 in Alert Mask registers, fan failure detection causes the $\overline{\text{FF/FS}}$ output to assert low. When a fan failure has been detected, the PWM duty cycle is forced immediately to the value in the FFDC register (03h).

Many 4-wire fans stop spinning when the applied PWM duty cycle is zero. When such a fan is used, set bit FF_0 (CR3.6) to 0. This disables fan-failure detection when the PWM duty cycle is zero or ramping down to zero. This prevents detecting a fan failure when the fan is intended to be stopped.

Some 4-wire fans are designed to continue spinning when the applied PWM duty cycle is zero. When such a fan is used, set bit FF_0 (CR3.6) to 1. This enables fan-failure detection for all values of duty cycle.

For 3-wire fans operating from a PWM-modulated power supply, fan operation stops when the duty cycle is zero. Therefore, when the PWM frequency is set to 33Hz, fan fault detection is disabled when PWM duty is zero or decreasing to zero.

The FF Mode bit (CR2.4) selects whether the $\overline{\text{FF/FS}}$ output operates in comparator mode or interrupt mode.

In comparator mode, $\overline{FF/FS}$ asserts upon detection of failure and de-asserts if the fan subsequently begins to spin again. The status bits will remain set if the fan begins to spin again. Writing 1 to CLR_FAIL bit (CR3.7) clears the fan fail status bits (TACH1A and TACH2A). These bits will set again if a fan failure is subsequently detected. Bit CR3.7 self-clears to 0. In Interrupt mode, $\overline{FF/FS}$ asserts upon detection of failure and remains asserted until the status bits are cleared by writing 1 to CLR_FAIL bit. In either mode, $\overline{FF/FS}$ and fault status can be cleared by disabling TACH inputs.

If $\overline{FF/FS}$ is pulled low externally by another device, and if the FS_ENABLE bit (CR2.3) is set to 1, the PWM duty cycle is forced to be 100%. An application for this feature is two devices that have their $\overline{FF/FS}$ pins connected together. If one device detects a fan failure and asserts its $\overline{FF/FS}$ pin, the $\overline{FF/FS}$ pin of the other device is also pulled low and therefore its PWM duty cycle is forced to 100% to compensate for the loss of cooling from the failed fans.

Fault Queue

The device features a “fault queue” to avoid false alarms. For a fault output (\overline{ALERT} , $\overline{FF/FS}$, or \overline{SHDN}) to be triggered, the fault must occur three consecutive times. The fault sources include out-of-limit temperature readings and fan failures.

Standby Mode

The device features a standby mode to conserve power. In the standby mode, temperature sensing, tachometer

pulse counting, and PWM output are stopped. The I²C interface remains active during the standby. Set the STBY bit (standby mode enable: CR2.7) to 1 to enable the standby mode.

I²C Serial Interface Description

I²C Definitions

The following terminology is commonly used to describe I²C data transfers. See the I²C timing diagram (Figure 1) and the *I²C AC Electrical Characteristics* table for additional information.

Master Device: The master device controls the slave devices on the bus. The master device generates SCL clock pulses and START and STOP conditions.

Slave Devices: Slave devices send and receive data at the master’s request.

Bus Idle or Not Busy: Time between STOP and START conditions when both SDA and SCL are inactive and in their logic high states. A STOP condition is the proper method to return the bus to the idle state.

START Condition: A START condition is generated by the master to initiate a new data transfer with a slave. Transitioning SDA from high to low while SCL remains high generates a START condition.

STOP Condition: A STOP condition is generated by the master to end a data transfer with a slave. Transitioning SDA from low to high while SCL remains high generates a STOP condition.

Repeated START Condition: The master can use a repeated START condition at the end of one data transfer to indicate that it will immediately initiate a new data transfer following the current one. Repeated STARTs are commonly used during read operations to identify a specific memory address to begin a data transfer. A repeated START condition is issued identically as a normal START condition,

Bit Write: Transitions of SDA must occur during the low state of SCL. The data on SDA must remain valid and unchanged during the entire high pulse of SCL plus the setup and hold time requirements. Data is shifted into the device during the rising edge of the SCL.

Bit Read: At the end of a write operation, the master must release the SDA bus line for the proper amount of setup time before the next rising edge of SCL during a bit read. The device shifts out each bit of data on SDA at the falling edge of the previous SCL pulse and the data bit is valid at the rising edge of the current SCL pulse.

Table 13. Available I²C Addresses

A2	A1	A0	SLAVE ADDRESS (HEX)
0	0	0	A0h
0	0	1	A2h
0	1	0	A4h
0	1	1	A6h
1	0	0	A8h
1	0	1	AAh
1	1	0	ACh
1	1	1	A Eh

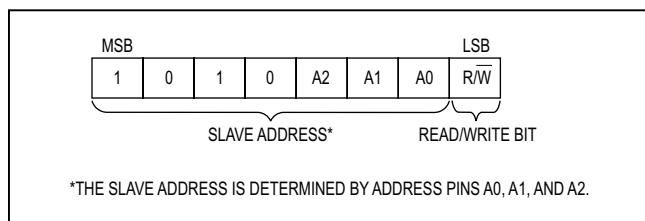

Figure 5. I²C Slave Address Byte

Remember that the master generates all SCL clock pulses, including when it is reading bits from the slave.

Acknowledgement (ACK and NACK): An acknowledgement (ACK) or not-acknowledge (NACK) is always the 9th bit transmitted during a byte transfer. The device receiving data (the master during a read or the slave during a write operation) performs an ACK by transmitting a 0 during the 9th bit. A device performs a NACK by transmitting a 1 (done by releasing SDA) during the 9th bit. Timing for the ACK and NACK is identical to all other bit writes (see Figure 1). An ACK is the acknowledgment that the device is properly receiving data. A NACK is used to terminate a read sequence or as an indication that the device is not receiving data.

Byte Write: A byte write consists of 8 bits of information transferred from the master to the slave (MSB first) plus a 1-bit acknowledgement from the slave to the master. The 8 bits transmitted by the master are done according to the bit write definition and the acknowledgement is read using the bit read definition.

Byte Read: A byte read is an 8-bit information transfer from the slave to the master plus a 1 bit ACK or NACK from the master to the slave. The 8 bits of information that

are transferred (MSB first) from the slave to the master are read by the master using the bit read definition previously described, and the master transmits an ACK using the bit write definition to receive additional data bytes. The master must NACK the last byte read to terminate communication so the slave returns control of SDA to the master.

Slave Address Byte: Each slave on the I²C bus responds to a slave address byte sent immediately following a START condition. The slave address byte contains the slave address in the seven MSBs and the R/W bit in the LSB.

As shown in Figure 5, the state of the A0, A1, and A2 address pins determine the device's slave address. Address pins connected to GND result in a 0 in the corresponding bit position in the slave address. Conversely, address pins connected to V_{DD} result in a 1 in the corresponding bit positions. Table 13 shows the eight selectable I²C addresses.

When the R/W bit is 0 (such as in A0h), the master is indicating it will write data to the slave. If R/W is set to a 1 (in this case, A1h), the master is indicating it wants to read from the slave.

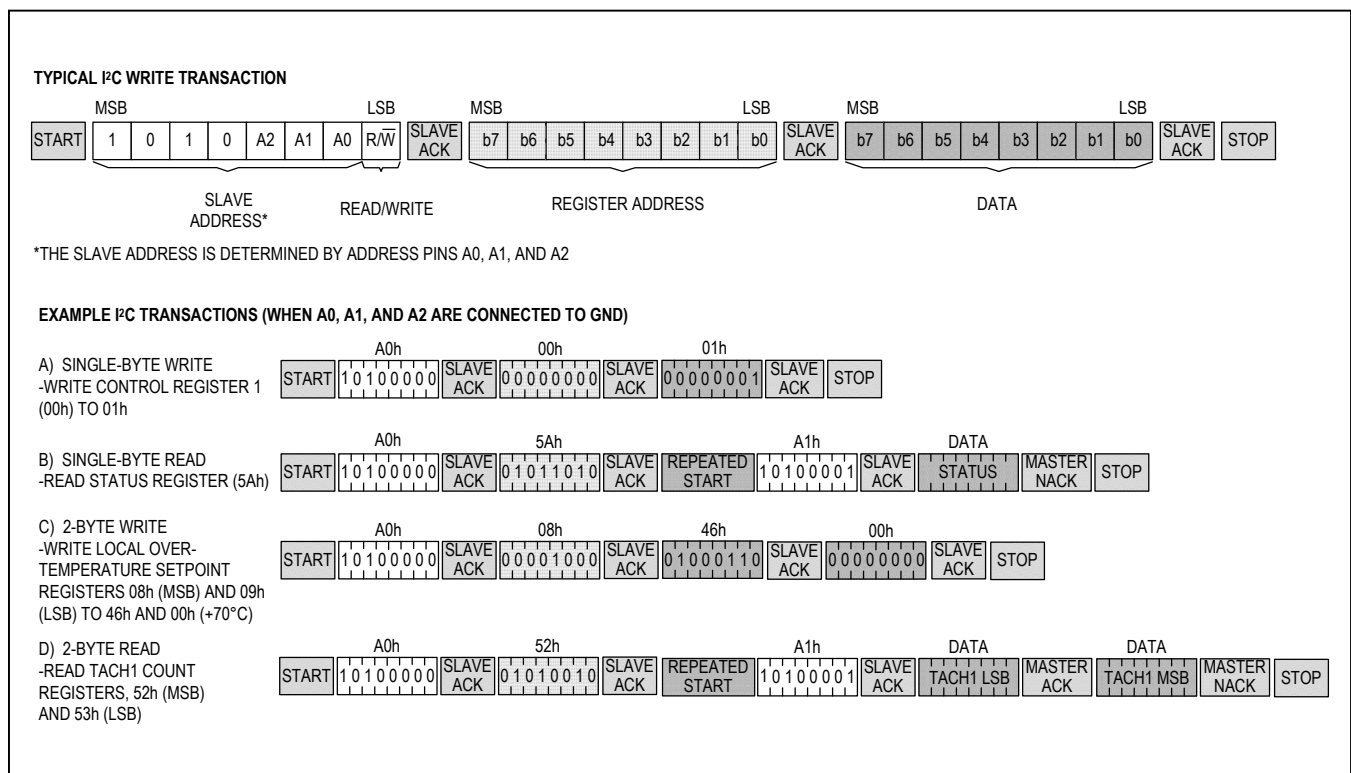

Figure 6. I²C Communication Examples

If an incorrect (nonmatching) slave address is written, the device assumes the master is communicating with another I²C device and ignores the communication until the next START condition is sent.

Memory Address: During an I²C write operation to the device, the master must transmit a memory address to identify the memory location where the slave is to store the data. The memory address is always the second byte transmitted during a write operation following the slave address byte.

I²C Communication

See [Figure 6](#) for I²C communication examples.

Writing a Single Byte to a Slave: The master must generate a START condition, write the slave address byte (R/W = 0), write the memory address, write the byte of data, and generate a STOP condition. The master must read the slave's acknowledgement during all byte write operations.

Writing Multiple Bytes to a Slave: To write multiple bytes to a slave, the master generates a START condition, writes the slave address byte (R/W = 0), writes the memory address, writes up to 8 data bytes, and generates a STOP condition. The device writes 1 to 8 bytes (one page or row) with a single write transaction. This is internally controlled by an address counter that allows data to be written to consecutive addresses without transmitting a memory address before each data byte is sent. The address counter limits the write to one 8-byte page (one row of the memory map). Attempts to write to additional pages of memory without sending a STOP condition between pages results in the address counter wrapping around to the beginning of the present row.

For example, a 3-byte write starts at address 06h and writes 3 data bytes (11h, 22h, and 33h) to three "consecutive" addresses. The result is that addresses 06h and 07h would contain 11h and 22h, respectively, and the third data byte, 33h, would be written to address 00h.

To prevent address wrapping from occurring, the master must send a STOP condition at the end of the page, then wait for the bus-free or EEPROM write time to elapse. Then the master can generate a new START condition and write the slave address byte (R/W = 0) and the first memory address of the next memory row before continuing to write data.

Acknowledge Polling: Any time a EEPROM byte is written, the device requires the EEPROM write time (t_W) after the STOP condition to write the contents of the byte

to EEPROM. During the EEPROM write time, the device does not acknowledge its slave address because it is busy. It is possible to take advantage of this phenomenon by repeatedly addressing the device, which allows communication to continue as soon as the device is ready. The alternative to acknowledge polling is to wait for a maximum period of t_W to elapse before attempting to access the device.

Writing to and Loading from EEPROM: The contents of the EEPROM are loaded into the corresponding control registers on POR, and on command. Initiate a load from EEPROM by writing 1 to bit 7 of the EEX register (5Bh) and also to the bits corresponding to the register ranges to be loaded. To write to EEPROM, write 0 to bit 7 and to the bits corresponding to the register ranges to be written. EEX bits always auto-clear to 0.

EEPROM Corruption and Recovery: Using the EEX register (5Bh), RAM can be written to EEPROM. If the power to the MAX31760 is interrupted during the EEPROM write cycle, there is a possibility that the data being written to the EEPROM will become corrupted. The MAX31760 can detect if this corruption has occurred, and will set the Program Corrupt bit (bit 7 of the Status Register; 5Ah) to a 1 to indicate that EEPROM corruption has been detected.

To recover from this, make sure the RAM locations are filled with the desired values, then execute an EEPROM write cycle using the EEX register (5Bh), making sure that power is stable for the duration of the write cycle. Once complete, either power cycle the MAX31760 or set the Soft POR bit (bit 6 of CR1; register 00h). Once the power cycle is complete, read the Program Corrupt bit to confirm that it has returned a 0 value, indicating that the EEPROM has been properly stored.

Reading a Single Byte from a Slave: Unlike the write operation that uses the specified memory address byte to define where the data is to be written, the read operation occurs at the present value of the memory address counter. To read a single byte from the slave, the master generates a START condition, writes the slave address byte with $R/\overline{W} = 1$, reads the data byte with a NACK to indicate the end of the transfer, and generates a STOP condition. However, because requiring the master to keep track of the memory address counter is impractical, the next method should be used to perform reads from a specified memory location.

Manipulating the Address Counter for Reads: A dummy write cycle can be used to force the address counter (or pointer) to a particular value. To do this, the master gen-

erates a START condition, writes the slave address byte ($R/\bar{W} = 0$), writes the memory address where it desires to read, generates a repeated START condition, writes the slave address byte ($R/\bar{W} = 1$), reads data with ACK or NACK as applicable, and generates a STOP condition. Recall that the master must NACK the last byte to inform the slave that no additional bytes will be read.

Reading Multiple Bytes from a Slave: The read operation can be used to read multiple bytes with a single transfer. When reading bytes from the slave, the master simply ACKs the data byte if it desires to read another byte before terminating the transaction. After the master reads the last byte it must NACK to indicate the end of the transfer and generates a STOP condition.

Register Memory Map

ADDRESS	READ/WRITE	NAME	LOADED FROM EEPROM AT POR?	FACTORY DEFAULT	FUNCTION
00h	Read/Write	CR1	Yes	01h	Control Register 1
01h	Read/Write	CR2	Yes	10h	Control Register 2
02h	Read/Write	CR3	Yes	03h	Control Register 3
03h	Read/Write	FFDC	Yes	FFh	Fan Fault Duty Cycle
04h	Read/Write	MASK	Yes	C0h	Alert Mask Register
05h	Read/Write	IFR	Yes	18h	Ideality Factor Register
06h	Read/Write	RHSH	Yes	55h	Remote High Set-point MSB
07h	Read/Write	RHSL	Yes	00h	Remote High Set-point LSB
08h	Read/Write	LOTSH	Yes	55h	Local Overtemperature Set-point MSB
09h	Read/Write	LOTSL	Yes	00h	Local Overtemperature Set-point LSB
0Ah	Read/Write	ROTSH	Yes	6Eh	Remote Overtemperature Set-point MSB
0Bh	Read/Write	ROTSL	Yes	00h	Remote Overtemperature Set-point LSB
0Ch	Read/Write	LHSH	Yes	46h	Local High Set-point MSB
0Dh	Read/Write	LHSL	Yes	00h	Local High Set-point LSB
0Eh	Read/Write	TCTH	Yes	FFh	TACH Count Threshold Register, MSB
0Fh	Read/Write	TCTL	Yes	FEh	TACH Count Threshold Register, LSB
10h–17h	Read/Write	USER	Yes	00h	8 Bytes of General-Purpose User Memory
20h–4Fh	Read/Write	LUT	Yes	FFh	48-Byte Lookup Table (LUT)
50h	Read/Write	PWMR	No	00h	Direct Duty-Cycle Control Register
51h	Read Only	PWMV	No	00h	Current PWM Duty-Cycle Register
52h	Read Only	TC1H	No	00h	TACH1 Count Register, MSB
53h	Read Only	TC1L	No	00h	TACH1 Count Register, LSB
54h	Read Only	TC2H	No	00h	TACH2 Count Register, MSB
55h	Read Only	TC2L	No	00h	TACH2 Count Register, LSB
56h	Read Only	RTH	No	00h	Remote Temperature Reading Register, MSB
57h	Read Only	RTL	No	00h	Remote Temperature Reading Register, LSB
58h	Read Only	LTH	No	00h	Local Temperature Reading Register, MSB
59h	Read Only	LTL	No	00h	Local Temperature Reading Register, LSB
5Ah	Read Only	SR	No	00h	Status Register
5Bh	Write Only	EEX	No	00h	Load EEPROM to RAM; Write RAM to EEPROM

Register 00h: Control Register 1 (CR1)

Factory Default Value: 01h
Memory Type: EEPROM, Nonvolatile

Memory Access	R/W	R/W	R/W	R/W	R/W	R/W	R/W	R/W
00h	ALTMSK	POR	HYST	DRV	DRV	PPS	MTI	TIS
	BIT 7						BIT 0	

BIT	NAME	DESCRIPTION
7	ALTMSK	Alert Mask 0 = Temperature alerts are enabled. 1 = Temperature alerts are masked.
6	POR	Software POR. Returns the MAX31760 to POR conditions. Loads EEPROM data into EEPROM-backed registers, returns all other registers to their default states. When set to 1, all other bits are ignored. Self-clears to 0.
5	HYST	Lookup Table Hysteresis 0 = 2°C (default) 1 = 4°C
4:3	DRV	PWM Frequency 00 = 33Hz 01 = 150Hz 10 = 1500Hz 11 = 25kHz Default is 00.
2	PPS	PWM Polarity 0 = Positive (100% setting is high) (default) 1 = Negative (100% setting is low)
1	MTI	Maximum Temperature as Index 0 = The temperature index is determined by TIS (CR1.0) (default). 1 = The temperature index is the greater of the local and remote temperatures.
0	TIS	Temperature Index Source 0 = Local temperature is used as the index to the LUT. 1 = Remote temperature is used as the index to the LUT (default).

Register 01h: Control Register 2 (CR2)

Factory Default Value: 10h
Memory Type: EEPROM, Nonvolatile

Memory Access	R/W	R/W	R/W	R/W	R/W	R/W	R/W	R/W
01h	STBY	ALERTS	SPEN	FF Mode	FS Enable	RDPS	FSST	DFC
	BIT 7							BIT 0

BIT	NAME	DESCRIPTION
7	STBY	Standby Mode Enable 0 = Normal operating mode (default). 1 = Standby mode.
6	ALERTS	ALERT Functionality Selection 0 = $\overline{\text{ALERT}}$ function as an interrupt (default). 1 = ALERT functions as a “comparator mode” fault indicator.
5	SPEN	Spin-Up Enable 0 = No spin-up when the fan starts up (default). 1 = Spin-up enabled. The PWM duty cycle is 100% until the end criterion is met (default).
4	FF Mode	FF Functionality Selection 0 = $\overline{\text{FF}}/\overline{\text{FS}}$ output functions as an interrupt. 1 = $\overline{\text{FF}}/\overline{\text{FS}}$ output functions as a “comparator mode” fault indicator (default).
3	FS Enable	FS Input Enable 0 = Externally driving $\overline{\text{FF}}/\overline{\text{FS}}$ has no effect on duty cycle. (default). 1 = Externally driving $\overline{\text{FF}}/\overline{\text{FS}}$ low forces 100% duty cycle.
2	RDPS	Rotation-Detection (RD) Signal-Polarity Selection. This bit becomes irrelevant when the FSST = 0. 0 = RD is at low level when the fan is running (default). 1 = RD is at high level when the fan is running.
1	FSST	Fan-Sense Signal Type 0 = Fan tachometer provides square-wave pulses (default). 1 = Fan provides rotation detection (RD) signal.
0	DFC	Direct Fan Control (Manual Mode) 0 = Direct fan control disabled (default). 1 = Direct fan control enabled.

Register 02h: Control Register 3 (CR3)

Factory Default Value: 03h
Memory Type: EEPROM, Nonvolatile

Memory Access	R/W	R/W	R/W	R/W	R/W	R/W	R/W	R/W
02h	CLR_FAIL	FF_0	RAMP1	RAMP0	TACHFULL	PSEN	TACH2E	TACH1E
	BIT 7			BIT 0				

BIT	NAME	DESCRIPTION																				
7	CLR_FAIL	Clear Fan Fail Status Bits 0 = Default; 1 = Clears any fan fail status bits to 0. Bits will be set again if failure is subsequently detected. Clears FF/FS output if FF interrupt mode is selected. This bit self-clears to 0.																				
6	FF_0	0 Duty-Cycle Fan-Fail Detection 0 = Fan-fail detection disabled when duty cycle = 0 or when ramping toward 0 (default value). 1 = Fan-fail detection enabled for all duty-cycle values.																				
5:4	RAMP[1:0]	PWM Duty-Cycle Ramp Rate																				
		<table border="1"> <thead> <tr> <th>RAMP1</th> <th>RAMP0</th> <th>PWM ADJUST RAMP RATE SELECT</th> <th>PWM DUTY-CYCLE CHANGE PER SECOND (%)</th> </tr> </thead> <tbody> <tr> <td>0</td> <td>0</td> <td>Slow (default)</td> <td>3.125 (default)</td> </tr> <tr> <td>0</td> <td>1</td> <td>Slow-Medium</td> <td>6.25</td> </tr> <tr> <td>1</td> <td>0</td> <td>Medium-Fast</td> <td>12.5</td> </tr> <tr> <td>1</td> <td>1</td> <td>Fast</td> <td>Immediate</td> </tr> </tbody> </table>	RAMP1	RAMP0	PWM ADJUST RAMP RATE SELECT	PWM DUTY-CYCLE CHANGE PER SECOND (%)	0	0	Slow (default)	3.125 (default)	0	1	Slow-Medium	6.25	1	0	Medium-Fast	12.5	1	1	Fast	Immediate
		RAMP1	RAMP0	PWM ADJUST RAMP RATE SELECT	PWM DUTY-CYCLE CHANGE PER SECOND (%)																	
		0	0	Slow (default)	3.125 (default)																	
		0	1	Slow-Medium	6.25																	
1	0	Medium-Fast	12.5																			
1	1	Fast	Immediate																			
3	TACHFULL	1 = Detect fan failure only when duty cycle =100%.																				
2	PSEN	Pulse Stretch Enable. Applies only for 33Hz PWM. 0 = Pulse stretch function is disabled (default). 1 = Pulse stretch function is enabled.																				
1	TACH2E	TACH2 Enable 0 = TACH2 monitoring function is disabled. Clears TACH2 fan fail status bit and FF/FS output. 1 = TACH2 monitoring function is enabled (default).																				
0	TACH1E	TACH1 Enable 0 = TACH1 monitoring function is disabled. Clears TACH1 fan fail status bit and FF/FS output. 1 = TACH1 monitoring function is enabled (default).																				

Register 03h: Fan Fault Duty Cycle (FFDC)

Factory Default Value: FFh

Memory Type:

Memory Access	R/W	R/W	R/W	R/W	R/W	R/W	R/W	R/W
03h	FFDC 7	FFDC 6	FFDC 5	FFDC 4	FFDC 3	FFDC 2	FFDC 1	FFDC 0
	BIT 7							BIT 0

BIT	NAME	DESCRIPTION
7	FFDC 7	FFDC [7:0] select the PWM duty cycle after a fan failure is detected per Table 9 .
6	FFDC 6	
5	FFDC 5	
4	FFDC 4	
3	FFDC 3	
2	FFDC 2	
1	FFDC 1	
0	FFDC 0	

Register 04h: Alert Mask Register (MASK)

Factory Default Value: C0h
Memory Type: EEPROM, Nonvolatile

Memory Access	N/A	N/A	R/W	R/W	R/W	R/W	R/W	R/W
04h	Reserved	Reserved	LHAM	LOTAM	RHAM	ROTAM	TACH2AM	TACH1AM
	BIT 7			BIT 0				

BIT	NAME	DESCRIPTION
7:6	Reserved	These bits should be set to 1.
5	LHAM	Local Temperature High Alarm Mask 0 = Local temperature high alarm causes $\overline{\text{ALERT}}$ to assert (default). 1 = Local temperature high alarm does not cause $\overline{\text{ALERT}}$ to assert.
4	LOTAM	Local Overtemperature Alarm Mask 0 = Local overtemperature alarm causes $\overline{\text{SHDN}}$ to assert (default). 1 = Local overtemperature alarm does not cause $\overline{\text{SHDN}}$ to assert.
3	RHAM	Remote High-Temperature Alarm Mask 0 = Remote temperature high alarm causes $\overline{\text{ALERT}}$ to assert (default). 1 = Remote temperature high alarm does not cause $\overline{\text{ALERT}}$ to assert.
2	ROTAM	Remote Overtemperature Alarm Mask: 0 = Remote overtemperature alarm causes $\overline{\text{SHDN}}$ to assert (default). 1 = Remote overtemperature alarm does not cause $\overline{\text{SHDN}}$ to assert.
1	TACH2AM	TACH2 Alarm Mask 0 = TACH2A alarm event causes $\overline{\text{FF/FS}}$ to assert (default). 1 = TACH2A alarm event does not cause $\overline{\text{FF/FS}}$ to assert.
0	TACH1AM	TACH1 Alarm Mask 0 = TACH1A alarm event causes $\overline{\text{FF/FS}}$ to assert (default). 1 = TACH1A alarm event does not cause $\overline{\text{FF/FS}}$ to assert.

Register 05h: Ideality Factor Register (IFR)

Factory Default Value: 18h
Memory Type: EEPROM, Nonvolatile

Memory Access	N/A	N/A	R/W	R/W	R/W	R/W	R/W	R/W
05h	Reserved	Reserved	IF5	IF4	IF3	IF2	IF1	IF0
	BIT 7			BIT 0				

BIT	NAME	DESCRIPTION
7:6	Reserved	These bits should be set to 0.
5	IF5	IF[5:0] determine the ideality factor used by the device. See Table 4 for details and settings. Default setting is 18h, corresponding to an ideality factor of 1.0080.
4	IF4	
3	IF3	
2	IF2	
1	IF1	
0	IF0	

Register 06h: Remote High Set-Point Register, MSB (RSHS)

Factory Default Value: 55h
Memory Type: EEPROM, Nonvolatile

Memory Access	R/W	R/W	R/W	R/W	R/W	R/W	R/W	R/W
06h	RHS15	RHS14	RHS13	RHS12	RHS11	RHS10	RHS9	RHS8
°C	Sign	2 ⁶	2 ⁵	2 ⁴	2 ³	2 ²	2 ¹	2 ⁰
	BIT 7							BIT 0

Register 07h: Remote High Set-Point Register, LSB (RHSL)

Factory Default Value: 00h
Memory Type: EEPROM, Nonvolatile

Memory Access	R/W	R/W	R/W	R/W	R/W	R/W	R/W	R/W
07h	RHS7	RHS6	RHS5	RHS4	RHS3	RHS2	RHS1	RHS0
°C	2 ⁻¹	2 ⁻²	2 ⁻³	0	0	0	0	0
	BIT 7							BIT 0

Register 08h: Local Overtemperature Set-Point Register, MSB (LOTSH)

Factory Default Value: 55h
Memory Type: EEPROM, Nonvolatile

Memory Access	R/W	R/W	R/W	R/W	R/W	R/W	R/W	R/W
08h	LOTS15	LOTS14	LOTS13	LOTS12	LOTS11	LOTS10	LOTS9	LOTS8
°C	Sign	2 ⁶	2 ⁵	2 ⁴	2 ³	2 ²	2 ¹	2 ⁰
	BIT 7							BIT 0

Register 09h: Local Overtemperature Set-Point Register, LSB (LOTSL)

Factory Default Value: 00h
Memory Type: EEPROM, Nonvolatile

Memory Access	R/W	R/W	R/W	R/W	R/W	R/W	R/W	R/W
09h	LOTS7	LOTS6	LOTS5	LOTS4	LOTS3	LOTS2	LOTS1	LOTS0
°C	2 ⁻¹	2 ⁻²	2 ⁻³	0	0	0	0	0
	BIT 7							BIT 0

Register 0Ah: Remote Overtemperature Set-Point Register, MSB (ROTSH)

Factory Default Value: 6Eh
Memory Type: EEPROM, Nonvolatile

Memory Access	R/W	R/W	R/W	R/W	R/W	R/W	R/W	R/W
0Ah	ROTS15	ROTS14	ROTS13	ROTS12	ROTS11	ROTS10	ROTS9	ROTS8
°C	Sign	2 ⁶	2 ⁵	2 ⁴	2 ³	2 ²	2 ¹	2 ⁰
	BIT 7							BIT 0

Register 0Bh: Remote Overtemperature Set-Point Register, LSB (ROTSL)

Factory Default Value: 00h
Memory Type: EEPROM, Nonvolatile

Memory Access	R/W	R/W	R/W	R/W	R/W	R/W	R/W	R/W
0Bh	ROTS7	ROTS6	ROTS5	ROTS4	ROTS3	ROTS2	ROTS1	ROTS0
°C	2 ⁻¹	2 ⁻²	2 ⁻³	0	0	0	0	0
	BIT 7							BIT 0

Register 0Ch: Local High Set-Point Register, MSB (LHSH)

Factory Default Value: 46h
Memory Type: EEPROM, Nonvolatile

Memory Access	R/W	R/W	R/W	R/W	R/W	R/W	R/W	R/W
0Ch	LHS15	LHS14	LHS13	LHS12	LHS11	LHS10	LHS9	LHS8
°C	Sign	2 ⁶	2 ⁵	2 ⁴	2 ³	2 ²	2 ¹	2 ⁰
	BIT 7							BIT 0

Register 0Dh: Local High Set-Point Register, LSB (LHSL)

Factory Default Value: 00h
Memory Type: EEPROM, Nonvolatile

Memory Access	R/W	R/W	R/W	R/W	R/W	R/W	R/W	R/W
0Dh	LHS7	LHS6	LHS5	LHS4	LHS3	LHS2	LHS1	LHS0
°C	2 ⁻¹	2 ⁻²	2 ⁻³	0	0	0	0	0
	BIT 7							BIT 0

Register 0Eh: TACH Count Threshold Register, MSB (TCTH)

Factory Default Value: FFh
Memory Type: EEPROM, Nonvolatile

Memory Access	R/W	R/W	R/W	R/W	R/W	R/W	R/W	R/W
0Eh	TCT_15	TCT_14	TCT_13	TCT_12	TCT_11	TCT_10	TCT_9	TCT_8
	BIT 7							BIT 0

BIT	NAME	DESCRIPTION
7	TCT_15	TCT_[15:8] are the upper 8 bits of for the TACH pulse counting threshold in unsigned format. Fan_RPM Threshold = $60 \times 100,000 / (TCTH_Value \times 256 + TCTL_Value) / n$ where n is the number of pulses generated by the tachometer per revolution.
6	TCT_14	
5	TCT_13	
4	TCT_12	
3	TCT_11	
2	TCT_10	
1	TCT_9	
0	TCT_8	

Register 0Fh: TACH Count Threshold Register, LSB (TCTL)

Factory Default Value: FEh
Memory Type: EEPROM, Nonvolatile

Memory Access	R/W	R/W	R/W	R/W	R/W	R/W	R/W	R/W
0Fh	TCT_7	TCT_6	TCT_5	TCT_4	TCT_3	TCT_2	TCT_1	TCT_0
	BIT 7							BIT 0

BIT	NAME	DESCRIPTION
7	TCT_7	TCT_[7:0] are the lower 8 bits of for the TACH pulse counting threshold in unsigned format.
6	TCT_6	
5	TCT_5	
4	TCT_4	
3	TCT_3	
2	TCT_2	
1	TCT_1	
0	TCT_0	

Registers 10h–17h: General-Purpose User EEPROM (USER)

Factory Default Value: 00h
Memory Type: EEPROM, Nonvolatile

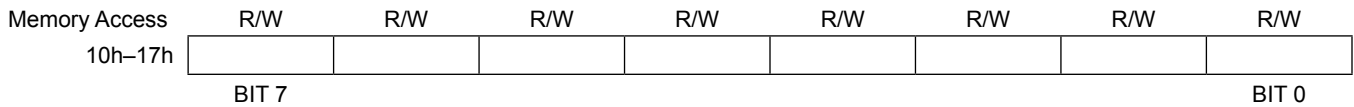

Registers 20h–4Fh: 48-Byte Lookup Table (LUT)

Factory Default Value: FFh
Memory Type: EEPROM, Nonvolatile

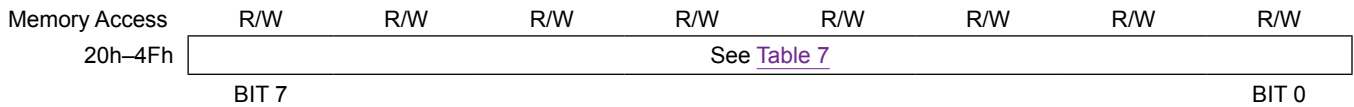

Register 50h: Direct Duty-Cycle Control Register (PWMR)

Default Value: FFh
Memory Type: SRAM, Volatile

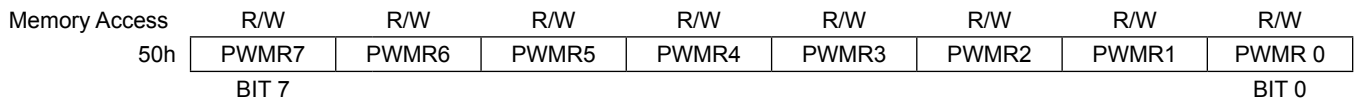

BIT	NAME	DESCRIPTION
7	PWMR7	PWMR[7:0] determine the PWM duty cycle per Table 9 in direct control mode (DFC bit (CR2.0) = 1)
6	PWMR6	
5	PWMR5	
4	PWMR4	
3	PWMR3	
2	PWMR2	
1	PWMR1	
0	PWMR0	

Register 51h: Current PWM Duty-Cycle Register (PWMV)

Default Value: 00h
Memory Type: SRAM, Volatile

Memory Access	R	R	R	R	R	R	R	R
51h	PWMV7	PWMV6	PWMV5	PWMV4	PWMV3	PWMV2	PWMV1	PWMV0
	BIT 7			BIT 0				

BIT	NAME	DESCRIPTION
7	PWMV7	PWMV[7:0] store the current PWM duty cycle at all times, including during fan failure.
6	PWMV6	
5	PWMV5	
4	PWMV4	
3	PWMV3	
2	PWMV2	
1	PWMV1	
0	PWMV0	

Register 52h: TACH1 Count Register, MSB (TC1H)

Default Value: 00h
Memory Type: SRAM, Volatile

Memory Access	R	R	R	R	R	R	R	R
52h	TC1_15	TC1_14	TC1_13	TC1_12	TC1_11	TC1_10	TC1_9	TC1_8
	BIT 7			BIT 0				

BIT	NAME	DESCRIPTION
7	TC1_15	TC1_[15:8] are the higher 8 bits for the TACH1 pulse counting in unsigned format. Fan_RPM = 60 x 100,000/(TC1H_Value x 256 + TC1L_Value)/n where n is the number of pulses generated by the tachometer per revolution.
6	TC1_14	
5	TC1_13	
4	TC1_12	
3	TC1_11	
2	TC1_10	
1	TC1_9	
0	TC1_8	

Register 53h: TACH1 Count Register, LSB (TC1L)

Default Value: 00h
Memory Type: SRAM, Volatile

Memory Access	R	R	R	R	R	R	R	R
53h	TC1_7	TC1_6	TC1_5	TC1_4	TC1_3	TC1_2	TC1_1	TC1_0
	BIT 7							BIT 0

BIT	NAME	DESCRIPTION
7	TC1_7	TC1_[7:0] are the lower 8 bits for the TACH1 pulse counting in unsigned format.
6	TC1_6	
5	TC1_5	
4	TC1_4	
3	TC1_3	
2	TC1_2	
1	TC1_1	
0	TC1_0	

Register 54h: TACH2 Count Register, MSB (TC2H)

Default Value: 00h
Memory Type: SRAM, Volatile

Memory Access	R	R	R	R	R	R	R	R
54h	TC2_15	TC2_14	TC2_13	TC2_12	TC2_11	TC2_10	TC2_9	TC2_8
	BIT 7							BIT 0

BIT	NAME	DESCRIPTION
7	TC2_15	TC2_[15:8] are the higher 8 bits for the TACH2 pulse counting in unsigned format. Fan_RPM = 60 x 100,000 / (TC12H_Value x 256 + TC2L_Value) / n where n is the number of pulses generated by the tachometer per revolution.
6	TC2_14	
5	TC2_13	
4	TC2_12	
3	TC2_11	
2	TC2_10	
1	TC2_9	
0	TC2_8	

Register 55h: TACH2 Count Register, LSB (TC2L)

Default Value: 00h
Memory Type: SRAM, Volatile

Memory Access	R	R	R	R	R	R	R	R
55h	TC2_7	TC2_6	TC2_5	TC2_4	TC2_3	TC2_2	TC2_1	TC2_0
	BIT 7							BIT 0

BIT	NAME	DESCRIPTION
7	TC2_7	TC2_[7:0] are the lower 8 bits for the TACH2 pulse counting in unsigned format.
6	TC2_6	
5	TC2_5	
4	TC2_4	
3	TC2_3	
2	TC2_2	
1	TC2_1	
0	TC2_0	

Register 56h: Remote Temperature Reading Register, MSB (RTH)

Factory Default Value: 00h
Memory Type: SRAM, Volatile

Memory Access	R	R	R	R	R	R	R	R
56h	RT15	RT14	RT13	RT12	RT11	RT10	RT9	RT8
°C	Sign	2 ⁶	2 ⁵	2 ⁴	2 ³	2 ²	2 ¹	2 ⁰
	BIT 7							BIT 0

Register 57h: Remote Temperature Reading Register, LSB (RTL)

Factory Default Value: 00h
Memory Type: SRAM, Volatile

Memory Access	R	R	R	R	R	R	R	R
57h	RT7	RT6	RT5	RT4	RT3	RT2	RT1	RT0
°C	2 ⁻¹	2 ⁻²	2 ⁻³	0	0	0	0	0
	BIT 7							BIT 0

Register 58h: Local Temperature Reading Register, MSB (LTH)

Factory Default Value: 00h
Memory Type: SRAM, Volatile

Memory Access	R	R	R	R	R	R	R	R
58h	LT15	LT14	LT13	LT12	LT11	LT10	LT9	LT8
°C	Sign	2 ⁶	2 ⁵	2 ⁴	2 ³	2 ²	2 ¹	2 ⁰
	BIT 7							BIT 0

Register 59h: Local Temperature Reading Register, LSB (LTL)

Factory Default Value: 00h
Memory Type: SRAM, Volatile

Memory Access	R	R	R	R	R	R	R	R
59h	LT7	LT6	LT5	LT4	LT3	LT2	LT1	LT0
°C	2 ⁻¹	2 ⁻²	2 ⁻³	0	0	0	0	0
	BIT 7							BIT 0

Register 5Ah: Status Register (SR)

Default Value: 00h
Memory Type: SRAM, Volatile

Memory Access	R	R	R	R	R	R	R	R
5Ah	PC bit	RDFA	LHA	LOTA	RHA	ROTA	TACH2A	TACH1A
	BIT 7							BIT 0

Note: Alarm bits in the SR register are cleared upon reading. If a fault is detected again after clearing, it is set again.

BIT	NAME	DESCRIPTION
7	PC bit	Program Corrupt Bit 0 = No EEPROM data corruption detected. 1 = An error has occurred during EEPROM programming. A successful write to EEPROM must occur followed by a POR or soft-POR before this bit will reset to 0.
6	RDFA	Remote Diode Fault Alarm 0 = Remote diode functions properly (default). 1 = Remote diode open-circuit or short-circuit fault detected. This fault does not trigger the ALERT output.
5	LHA	Local High Temperature Alarm 0 = The temperature of the IC die is at or lower than the local high set point (default). 1 = The temperature of the IC die is higher than the local high set point.
4	LOTA	Local Overtemperature Alarm 0 = The local temperature is at or lower than the local overtemperature set point (default). 1 = The local temperature is higher than the local overtemperature set point.

Register 5Ah: Status Register (SR) (continued)

BIT	NAME	DESCRIPTION
3	RHA	Remote Temperature High Alarm 0 = The temperature of the remote diode is at or lower than the remote high set point (default). 1 = The temperature of the remote diode is higher than the remote high set point.
2	ROTA	Remote Overtemperature Alarm 0 = The temperature of the remote diode is at or lower than the overtemperature set point (default). 1 = The temperature of the remote diode is higher than the overtemperature set point.
1	TACH2A	TACH2 Alarm 0 = The fan sensed by TACH2 is running properly (default). If tachometer pulses are provided to TACH2, this means the TACH2 count is lower than or equal to the value in TACH Count Threshold registers (the fan is running at an RPM higher than the minimum acceptable value). If RD signal is provided to TACH2, this means the fan is running. 1 = The fan sensed by TACH2 is not running properly. This happens when the fan is running at an RPM lower than the minimum acceptable value, or the fan is not rotating at all, or an overflow occurred during counting.
0	TACH1A	TACH1 Alarm 0 = The fan sensed by TACH1 is running properly. If tachometer pulses are provided to TACH1, this means the TACH1 count is lower than or equal to the value in TACH Count Threshold registers (the fan is running at an RPM higher than the minimum acceptable value). If RD signal is provided to TACH1, this means the fan is running. 1 = The fan sensed by TACH1 is not running properly. This happens when the fan is running at an RPM lower than the minimum acceptable value, or the fan is not rotating at all, or an overflow occurred during counting.

Register 5Bh: EEPROM LOAD/WRITE Register (EEX)

Factory Default Value: 00h
Memory Type: SRAM, Volatile

Memory Access	R/W	N/A	N/A	R/W	R/W	R/W	R/W	R/W
5Bh	L/W	Reserved	Reserved	40h–4Fh	30h–3Fh	20h–2Fh	10h–1Fh	00h–0Fh
	BIT 7	Clears to 00h when read.						BIT 0

BIT	NAME	DESCRIPTION
7	L/W	0 = Write RAM to EEPROM 1 = Load EEPROM to RAM
6	Reserved	Reserved
5	Reserved	Reserved
4	40h–4Fh	1 = Bytes 40h through 4Fh
3	30h–3Fh	1 = Bytes 30h through 3Fh
2	20h–2Fh	1 = Bytes 20h through 2Fh
1	10h–1Fh	1 = Bytes 10h through 1Fh
0	00h–0Fh	1 = Bytes 00h through 0Fh

Applications Information

ADC Noise Filtering

The integrating ADC has inherently good noise rejection, especially of low-frequency signals such as 60Hz/120Hz power-supply hum. However, micropower operation places constraints on high-frequency noise rejection. Lay out the PCB carefully with proper external noise filtering for high-accuracy remote measurements in electrically noisy environments. Filter high-frequency electromagnetic interference (EMI) at the DXP pin with an external 2200pF capacitor connected between DXP and DXN. A capacitance higher than 2200pF introduces errors due to the rise time of the switched-current source.

Power-Supply Decoupling

To achieve the best results when using the device, decouple the V_{DD} power supply with a 0.1 μ F capacitor. Use a high-quality, ceramic, surface-mount capacitor if possible. Surface-mount components minimize lead inductance, which improves performance, and ceramic capacitors tend to have adequate high-frequency response for decoupling applications.

Twisted Pairs and Shielded Cables

For remote-sensor distances longer than 8in, or in particularly noisy environments, a twisted pair is recommended. Its practical length is 6ft to 12ft (typ) before noise becomes a problem, as tested in a noisy electronics laboratory. For longer distances, the best solution is a shielded twisted pair like that used for audio microphones. For example, Belden 8451 works well for distances up to 100ft in a noisy environment. Connect the twisted pair to DXP and DXN and the shield to ground, and leave the shield's remote end unterminated. Excess capacitance at DXP limits practical remote-sensor distances. For very long cable runs, the cable's parasitic capacitance often provides noise filtering, so the recommended 2200pF capacitor can often be removed or reduced in value. Cable resistance also affects remote-sensor accuracy. A 1 Ω series resistance introduces about +1/2 $^{\circ}$ C error.

PCB Layout Checklist

- 1) When possible, place the device as close as possible to the remote diode. In a noisy environment, such as a computer motherboard, this distance can be 4in to 8in or more, as long as the worst noise sources (such as CRTs, clock generators, memory buses, and ISA/PCI buses) are avoided.
- 2) Do not route the DXP lines next to the deflection coils of a CRT. Also, do not route the traces across a fast memory bus, which can easily introduce +30 $^{\circ}$ C error, even with good filtering. Otherwise, most noise sources are fairly benign.
- 3) Route the DXP and DXN traces parallel and close to each other, away from any high-voltage traces such as +12V DC. Avoid leakage currents from PCB contamination.
- 4) Route as few vias and crossunders as possible to minimize copper/solder thermocouple effects.
- 5) When connecting a thermocouple, make sure that both the DXP and the DXN paths have matching thermocouples leads. In general, PCB-induced thermocouples are not a serious problem. A copper solder thermocouple exhibits 3 μ V/ $^{\circ}$ C, and it takes approximately 200 μ V of voltage error at DXP/GND to cause a +1 $^{\circ}$ C measurement error, so most parasitic thermocouple errors are swamped out.
- 6) Use wide traces. Narrow traces are more inductive and tend to pick up radiated noise. The 10-mil widths and spacings are recommended, but are not absolutely necessary (as they offer only a minor improvement in leakage and noise), but use them where practical.
- 7) Placing an electrically clean copper ground plane between the DXP and DXN traces and traces carrying high-frequency noise signals helps reduce EMI.

Ordering Information

PART	TEMP RANGE	PIN-PACKAGE
MAX31760AEE+	-40°C to +125°C	16 QSOP
MAX31760AEE+T	-40°C to +125°C	16 QSOP

+Denotes a lead(Pb)-free/RoHs-compliant package.

Package Information

For the latest package outline information and land patterns (footprints), go to www.maximintegrated.com/packages. Note that a "+", "#", or "-" in the package code indicates RoHS status only. Package drawings may show a different suffix character, but the drawing pertains to the package regardless of RoHS status.

PACKAGE TYPE	PACKAGE CODE	OUTLINE NO.	LAND PATTERN NO.
16 QSOP	E16+1	21-0055	90-0167

Revision History

REVISION NUMBER	REVISION DATE	DESCRIPTION	PAGES CHANGED
0	4/14	Initial release	—

For pricing, delivery, and ordering information, please contact Maxim Direct at 1-888-629-4642, or visit Maxim Integrated's website at www.maximintegrated.com.

Maxim Integrated cannot assume responsibility for use of any circuitry other than circuitry entirely embodied in a Maxim Integrated product. No circuit patent licenses are implied. Maxim Integrated reserves the right to change the circuitry and specifications without notice at any time. The parametric values (min and max limits) shown in the Electrical Characteristics table are guaranteed. Other parametric values quoted in this data sheet are provided for guidance.

Mouser Electronics

Authorized Distributor

Click to View Pricing, Inventory, Delivery & Lifecycle Information:

[Maxim Integrated:](#)

[MAX31760AEE+T](#) [MAX31760AEE+](#)