

200mA/250mA/300mA Current-Limit Switches

ABSOLUTE MAXIMUM RATINGS

IN, ON, $\overline{\text{FLAG}}$, OUT to GND-0.3V to +6V
 OUT Short Circuit to GNDInternally Limited
 Continuous Power Dissipation ($T_A = +70^\circ\text{C}$)
 4-Pin SOT143 (derate 4.0mW/ $^\circ\text{C}$ above +70 $^\circ\text{C}$).....320mW
 5-Pin SOT23 (derate 7.1mW/ $^\circ\text{C}$ above +70 $^\circ\text{C}$).....571mW
 6-Pin TDFN (derate 24.4mW/ $^\circ\text{C}$ above +70 $^\circ\text{C}$).....1951.2mW

Operating Temperature Range-40 $^\circ\text{C}$ to +85 $^\circ\text{C}$
 Junction Temperature+150 $^\circ\text{C}$
 Storage Temperature Range-65 $^\circ\text{C}$ to +150 $^\circ\text{C}$
 Lead Temperature (soldering, 10s)+300 $^\circ\text{C}$

Stresses beyond those listed under "Absolute Maximum Ratings" may cause permanent damage to the device. These are stress ratings only, and functional operation of the device at these or any other conditions beyond those indicated in the operational sections of the specifications is not implied. Exposure to absolute maximum rating conditions for extended periods may affect device reliability.

ELECTRICAL CHARACTERISTICS

($V_{IN} = 2.3\text{V}$ to 5.5V , $T_A = -40^\circ\text{C}$ to $+85^\circ\text{C}$, unless otherwise noted. Typical values are at $V_{IN} = 3.3\text{V}$, $T_A = +25^\circ\text{C}$.) (Note 1)

PARAMETER	SYMBOL	CONDITIONS	MIN	TYP	MAX	UNITS
Operating Voltage	V_{IN}		2.3		5.5	V
Quiescent Current	I_Q	$V_{ON} = V_{IN}$, $I_{OUT} = 0$, switch on		80	120	μA
		$V_{IN} = +2.3\text{V}$ to $+5.0\text{V}$				
		$V_{IN} = +5.0\text{V}$ to $+5.5\text{V}$			160	
Latch-Off Current (Note 2)	I_{LATCH}	$V_{ON} = V_{IN}$, after an overcurrent fault (MAX4789/MAX4791/MAX4793)		8	15	μA
Shutdown Current	I_{SHDN}	$V_{ON} = 0\text{V}$		0.01	1	μA
Forward Current Limit		MAX4789/MAX4790	200		300	mA
		MAX4791/MAX4792	250		375	
		MAX4793/MAX4794	300		450	
Reverse Current Limit		MAX4789/MAX4790			300	mA
		MAX4791/MAX4792			375	
		MAX4793/MAX4794			450	
Shutdown Reverse Leakage		$V_{ON} = 0$, $V_{IN} = 3\text{V}$, $V_{OUT} = 5\text{V}$		100		μA
ON Input Leakage		$V_{ON} = V_{IN}$ or GND	-1		+1	μA
Off Switch Leakage		$V_{ON} = 0\text{V}$, $V_{OUT} = 0\text{V}$		0.01	1	μA
Undervoltage Lockout	UVLO	Rising edge	1.8		2.2	V
Undervoltage Lockout Hysteresis				100		mV
On-Resistance	R_{ON}	$T_A = +25^\circ\text{C}$, $I_{OUT} = 100\text{mA}$		0.2	0.4	Ω
		$T_A = -40^\circ\text{C}$ to $+85^\circ\text{C}$, $I_{OUT} = 100\text{mA}$			0.5	
ON Input Logic High Voltage	V_{IH}		2.0			V
ON Input Logic Low Voltage	V_{IL}				0.8	V
$\overline{\text{FLAG}}$ Output Logic Low Voltage		$I_{SINK} = 1\text{mA}$ (MAX4789/MAX4791/MAX4793)			0.4	V
$\overline{\text{FLAG}}$ Output High Leakage Current		$V_{IN} = V_{\overline{\text{FLAG}}} = 5.5\text{V}$ (MAX4789/MAX4791/MAX4793)			1	μA
Thermal Shutdown				150		$^\circ\text{C}$
Thermal-Shutdown Hysteresis				15		$^\circ\text{C}$
DYNAMIC						
Turn-On Time (Note 3)		V_{ON} from low to high; $I_{OUT} = 10\text{mA}$, $C_L = 0.1\mu\text{F}$		100		μs
Turn-Off Time (Note 3)		V_{ON} from high to low; $I_{OUT} = 10\text{mA}$, $C_L = 0.1\mu\text{F}$		40		ns

200mA/250mA/300mA Current-Limit Switches

ELECTRICAL CHARACTERISTICS (continued)

($V_{IN} = 2.3V$ to $5.5V$, $T_A = -40^{\circ}C$ to $+85^{\circ}C$, unless otherwise noted. Typical values are at $V_{IN} = 3.3V$, $T_A = +25^{\circ}C$.) (Note 1)

PARAMETER	SYMBOL	CONDITIONS	MIN	TYP	MAX	UNITS
Blanking Time	t _{BLANK}	Overcurrent fault (Figures 2, 3)	14		60	ms
Short-Circuit Current-Limit Response Time		$V_{ON} = V_{IN} = 3.3V$, short circuit applied to OUT		5		μs
Retry Time (Note 4)	t _{RETRY}	MAX4790/MAX4792/MAX4794 (Figure 2)	98		420	ms

Note 1: All parts are 100% tested at $+25^{\circ}C$. Limits across the full temperature range are guaranteed by design and correlation.

Note 2: Latch-off current does not include the current flowing into FLAG.

Note 3: The on time is defined as the time taken for the current through the switch to go from 0mA to full load. The off-time is defined as the time taken for the current through the switch to go from full load to 0mA.

Note 4: Retry time is typically 7 times the blanking time.

Typical Operating Characteristics

($V_{IN} = 3.3V$, $T_A = +25^{\circ}C$, unless otherwise noted.)

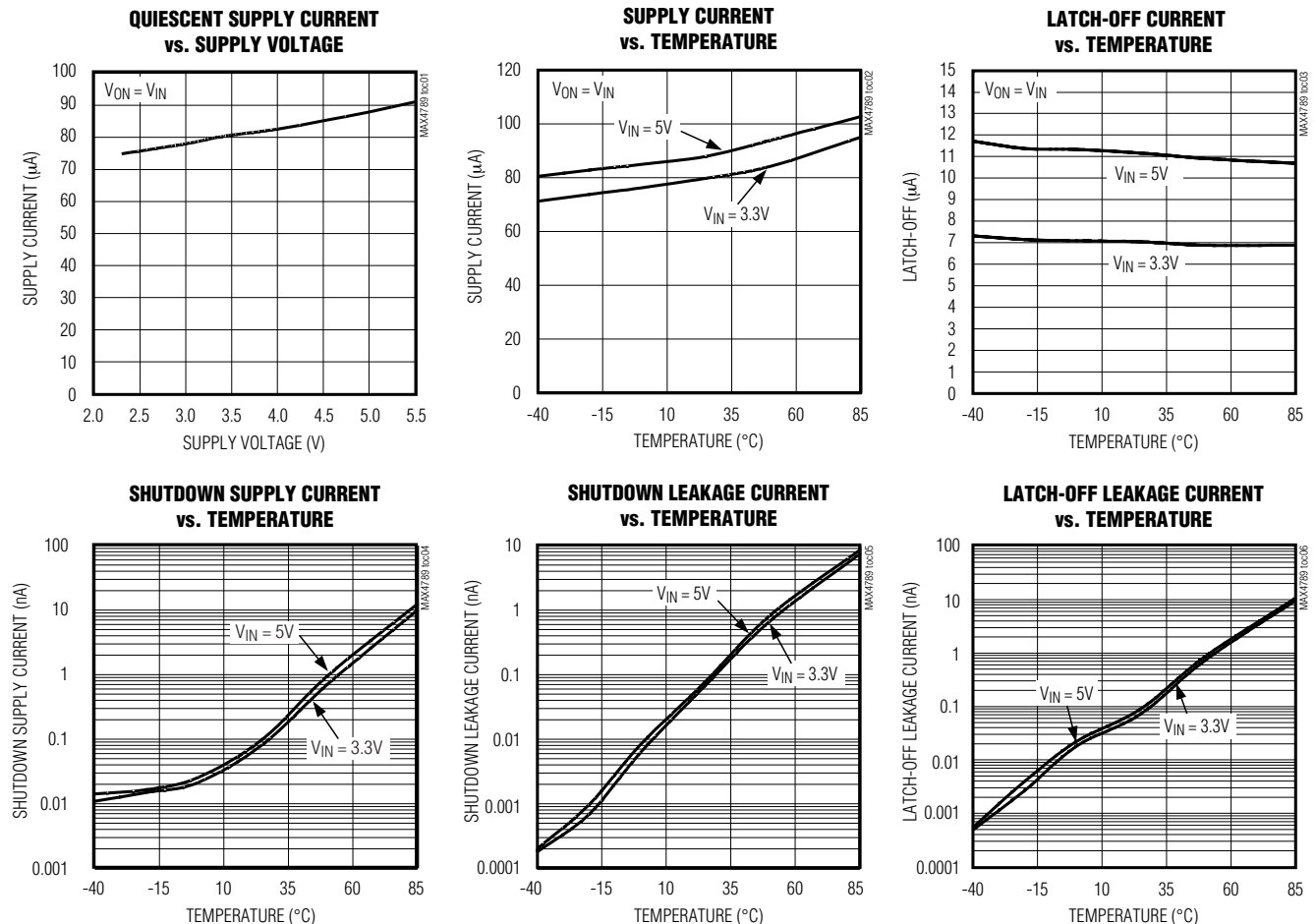

200mA/250mA/300mA Current-Limit Switches

Typical Operating Characteristics (continued)

($V_{IN} = 3.3V$, $T_A = +25^\circ C$, unless otherwise noted.)

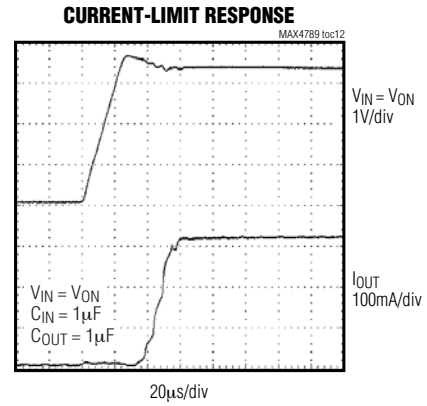
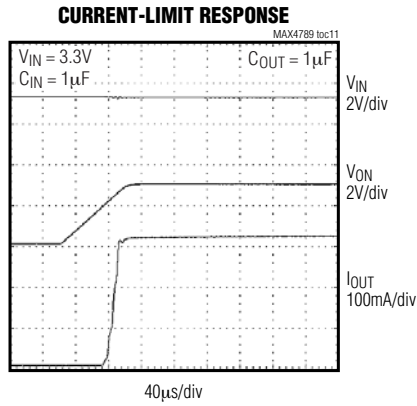
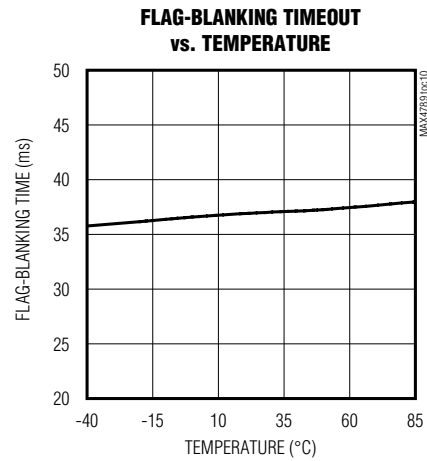
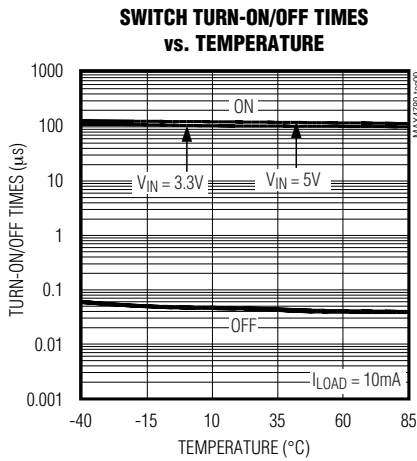
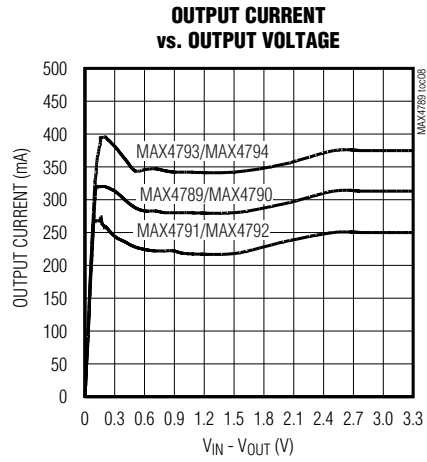
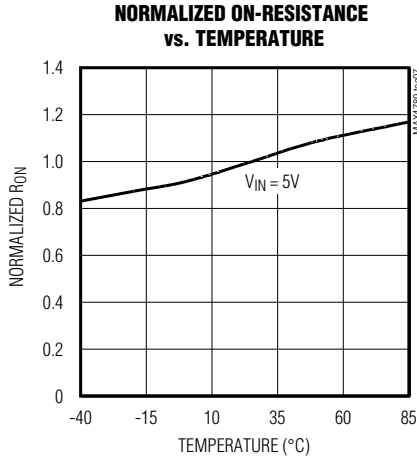

200mA/250mA/300mA Current-Limit Switches

MAX4789-MAX4794

Typical Operating Characteristics (continued)

($V_{IN} = 3.3V$, $T_A = +25^\circ C$, unless otherwise noted.)

**CURRENT-LIMIT RESPONSE
(OUT SHORTED TO GND)**

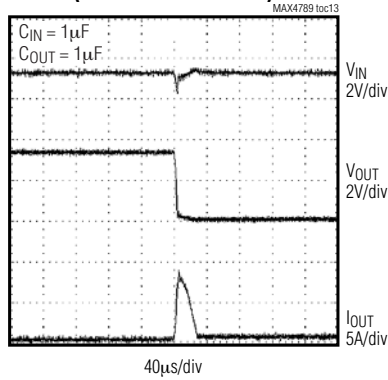

SWITCH TURN-ON TIME RESPONSE

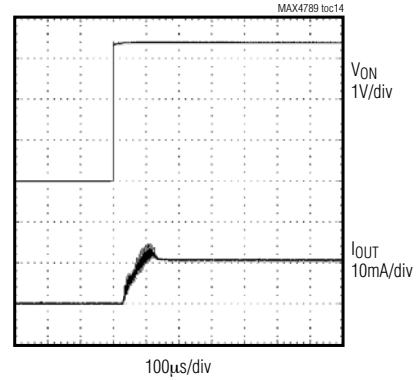

SWITCH TURN-OFF TIME RESPONSE

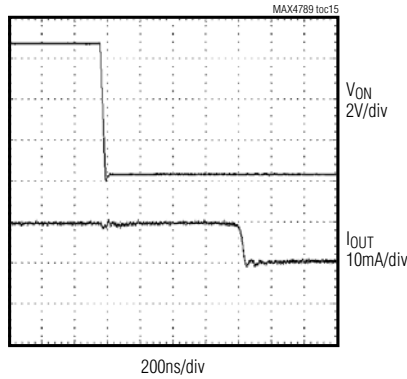

FLAG-BLANKING RESPONSE

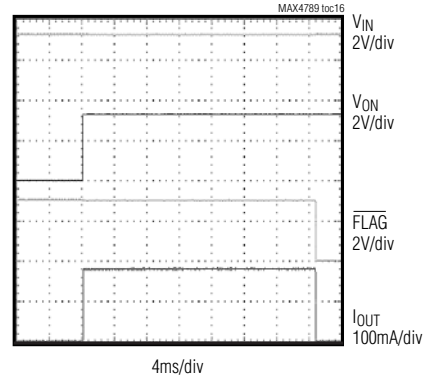

Pin Description

PIN				NAME	FUNCTION
TDFN-EP	TDFN-EP	5-SOT23	4-SOT143		
MAX4789	MAX4790	MAX4789	MAX4789-	FLAG	Fault Output. This open-drain output goes low when the device stays in forward or reverse current limit for more than the blanking time period. FLAG is high impedance when a fault is not present or when ON is low.
MAX4791	MAX4792	MAX4791	MAX4794		
MAX4793	MAX4794	MAX4793			
1	—	4	—	GND	Ground
2	2	2	2	ON	Active-High Switch On Input. A logic high turns the switch on.
3	3	3	3	N.C.	No Connection. Not internally connected.
4	1, 4	—	—	IN	Input. Bypass IN with a 0.1 μF ceramic capacitor to ground.
5	5	1	4	OUT	Switch Output. Bypass OUT with a 0.1 μF ceramic capacitor to ground.
6	6	5	1	EP	Exposed paddle. Connect EP to a large ground plane to maximize thermal performance. EP is not intended as an electrical connection point. (TDFN Package only.)

200mA/250mA/300mA Current-Limit Switches

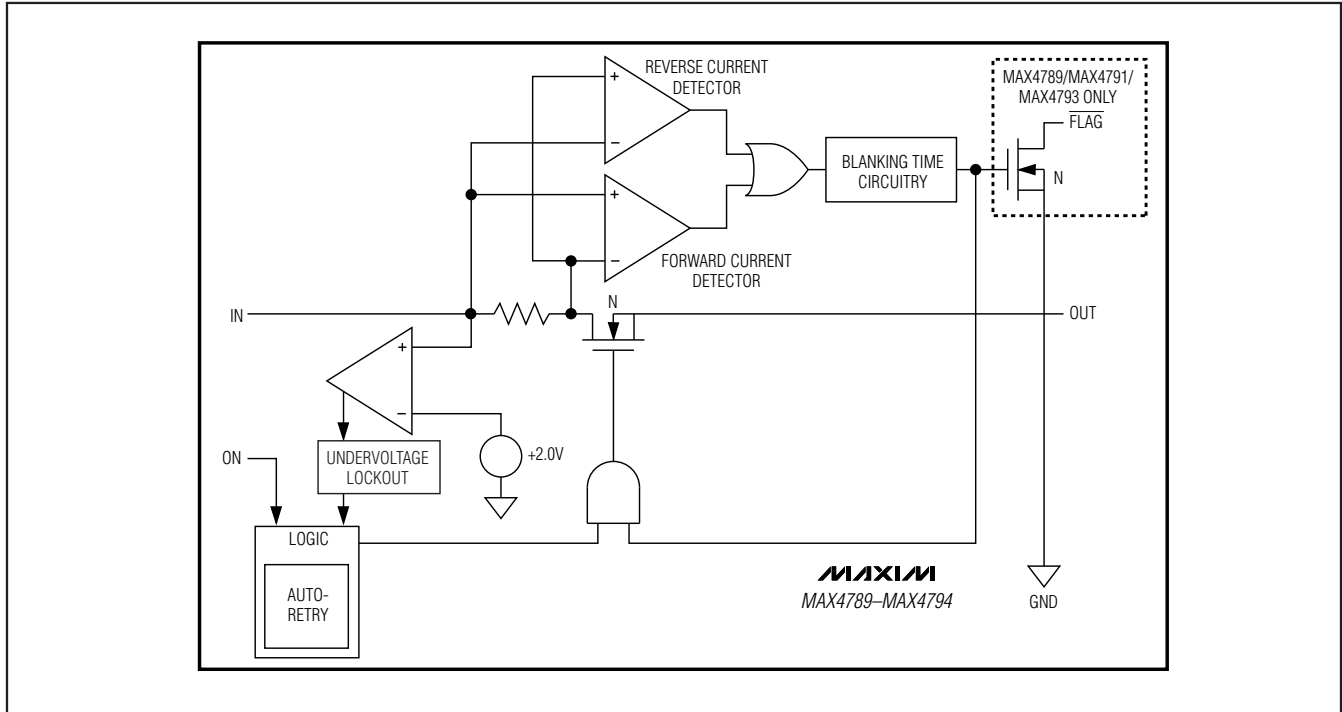

Figure 1. Functional Diagram

Detailed Description

The MAX4789-MAX4794 are forward/reverse current-limited switches that operate from a 2.3V to 5.5V input voltage range and guarantee a 200mA, 250mA, and 300mA minimum current-limit threshold for different options. The voltage drop across an internal sense resistor is compared to two reference voltages to indicate a forward or reverse current-limit fault. When the load current exceeds the preset current limit for greater than the fault-blanking time, the switch opens.

The MAX4790, MAX4792, and MAX4794 have an autoretry function that turns on the switch again after an internal retry time expires. If the faulty load condition is still present after the blanking time, the switch turns off again and the cycle is repeated. If the faulty load condition is not present, the switch remains on.

The MAX4789, MAX4791, and MAX4793 do not have the autoretry option and the switch remains in latch-off mode until the ON pin or the input power is cycled from high to low and then high again.

The undervoltage lockout (UVLO) circuit prevents erroneous switch operation when the input voltage goes too low during startup conditions.

Reverse Current Protection

The MAX4789-MAX4794 limit the reverse current (V_{OUT} to V_{IN}) from exceeding the maximum I_{REV} value. The switch is shut off and \overline{FLAG} is asserted (MAX4789/MAX4791/MAX4793) if the reverse current-limit condition persists for more than the blanking time. This feature prevents excessive reverse currents from flowing through the device.

Switch-On/Off Control

Toggle ON high to enable the current-limited switches. The switches are continuously on, only if V_{IN} exceeds the UVLO threshold (typically 2V) and there is no fault. When a forward/reverse current fault is present or the die exceeds the thermal-shutdown temperature of +150°C, OUT is internally disconnected from IN and the supply current decreases to 8 μ A (latch off). The switch is now operating in one of its off states. The switch-off state also occurs when driving ON low, thus reducing the supply current (shutdown) to 0.01 μ A. Table 1 illustrates the ON/OFF state of the MAX4789-MAX4794 current-limit switches.

\overline{FLAG} Indicator

The MAX4789, MAX4791, and MAX4793 feature a latched fault output, \overline{FLAG} . Whenever a fault is activated, it latches \overline{FLAG} output low and also turns the switch

200mA/250mA/300mA Current-Limit Switches

Table 1. MAX4789–MAX4794 Switch Truth Table

ON	FAULT	SWITCH ON/OFF	SUPPLY CURRENT MODE
Low	X	OFF	Shutdown
High	Undervoltage Lockout	OFF	Shutdown
High	Thermal	OFF immediately (t_{BLANK} period does not apply)	Latch off
High	Current Limit	OFF after t_{BLANK} period has elapsed	Latch off
		ON during t_{BLANK} period, OFF during t_{RETRY} period for the MAX4790, MAX4792, and MAX4794; cycle repeats until fault is removed	See the <i>Autoretry</i> section

off. \overline{FLAG} is an open-drain output transistor and requires an external pullup resistor from \overline{FLAG} to IN. During shutdown (ON is low), the pulldown on \overline{FLAG} output is released in order to limit power dissipation. \overline{FLAG} goes low when any of the following conditions occur:

- The die temperature exceeds the thermal-shutdown temperature limit of +150°C.
- The device is in current limit for more than the fault-blanking period.
- V_{IN} is below UVLO threshold.

Autoretry (MAX4790/MAX4792/MAX4794)

When the forward or reverse current-limit threshold is exceeded, t_{BLANK} timer begins counting (Figure 2). The timer resets if the overcurrent condition disappears before t_{BLANK} has elapsed. A retry time delay, t_{RETRY} , is started immediately after t_{BLANK} has elapsed and during that time, the switch is latched off. At the end of t_{RETRY} , the switch is turned on again. If the fault still exists, the cycle is repeated. If the fault has been removed, the switch stays on.

The autoretry feature saves system power in the case of an overcurrent or short-circuit condition. During t_{BLANK} , when the switch is on, the supply current is at the current limit. During t_{RETRY} , when the switch is off, the current through the switch is zero. Instead of observing the full load current, the switch sees the equivalent load current times duty cycle or $I_{SUPPLY} = I_{LOAD} \times t_{BLANK} / (t_{BLANK} + t_{RETRY})$. With a typical $t_{BLANK} = 37\text{ms}$ and typical $t_{RETRY} = 259\text{ms}$, the duty cycle is 12%, which results in an 88% power savings over the switch being on the entire time. The duty cycle is consistent across the process and devices.

Latch Off (MAX4789/MAX4791/MAX4793)

When the forward or reverse current-limit threshold is exceeded, t_{BLANK} timer begins counting. The timer resets if the overcurrent condition disappears before t_{BLANK} has elapsed. The switch is shut off if the overcurrent condition continues up to the end of the blank-

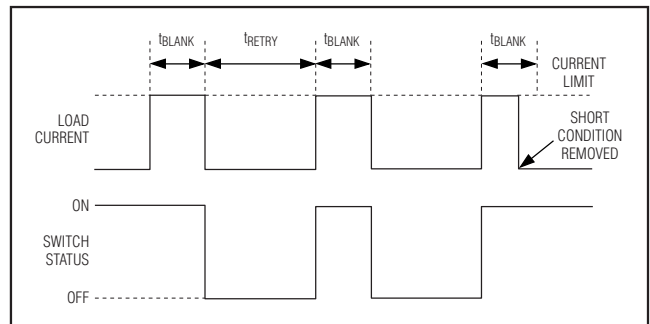

Figure 2. MAX4790/MAX4792/MAX4794 Autoretry Fault Blanking Diagram

ing time. Reset the switch by either toggling ON (Figure 3a) or cycling the input voltage below UVLO, typically 2V (Figure 3b).

Fault Blanking

The MAX4789–MAX4794 feature 14ms (min) fault blanking. Fault blanking allows current-limit faults, including momentary short-circuit faults that occur when hot swapping a capacitive load, and also ensures that no fault is issued during power-up. When a load transient causes the device to enter current limit, an internal counter starts. If the load-transient fault persists beyond the fault-blanking timeout, the MAX4789/MAX4791/MAX4793 \overline{FLAG} asserts low. Load-transient faults less than t_{BLANK} do not cause a \overline{FLAG} output assertion. Only current-limit faults are blanked.

A thermal fault and input voltage drops below the UVLO threshold cause \overline{FLAG} to assert immediately and do not wait for the blanking time.

Thermal Shutdown

The MAX4789–MAX4794 have a thermal shutdown feature to protect the devices from overheating. The switch turns off and \overline{FLAG} goes low immediately (no fault blanking) when the junction temperature exceeds +150°C. The switch turns back on when the device temperature drops approximately 15°C.

200mA/250mA/300mA Current-Limit Switches

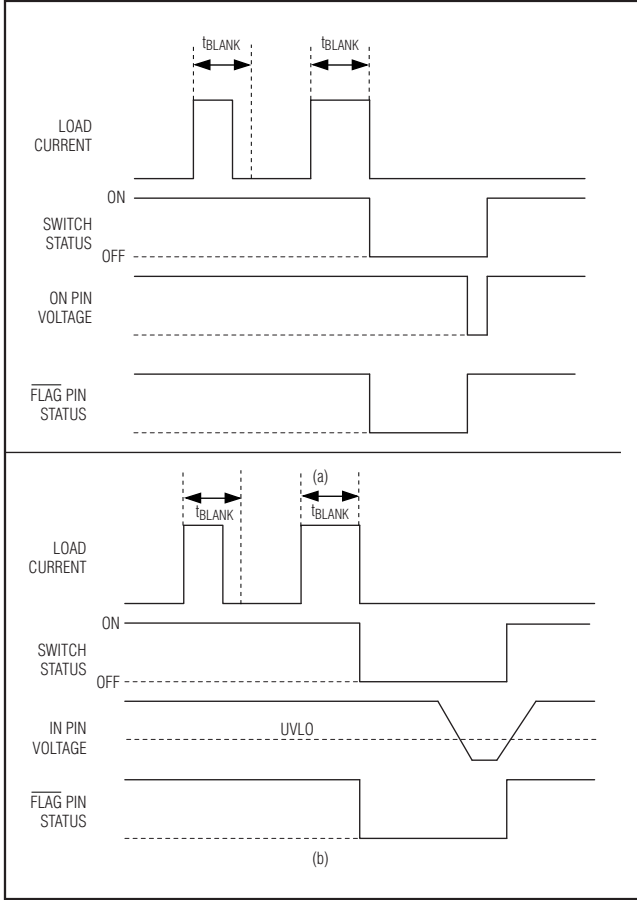

Figure 3. MAX4789/MAX4791/MAX4793 Latch-Off Fault Blanking

Applications Information

Input Capacitor

To limit the input voltage drop during momentary output short-circuit conditions, connect a capacitor from IN to GND. A 0.1µF ceramic capacitor is adequate for most applications; however, higher capacitor values further reduce the voltage drop at the input and are recommended for lower voltage applications.

Output Capacitance

Connect a 0.1µF capacitor from OUT to GND. This capacitor helps prevent inductive parasitics from pulling OUT negative during turn-off, thus preventing

the MAX4789-MAX4794 from tripping erroneously. If the load capacitance is too large, then current may not have enough time to charge the capacitance and the device assumes that there is a faulty load condition. The maximum capacitive load value that can be driven from OUT is obtained by the following formula:

$$C_{MAX} < \frac{I_{FWD_MIN} \times t_{BLANK_MIN}}{V_{IN}}$$

Layout and Thermal Dissipation

To optimize the switch response time to output short-circuit conditions, it is very important to keep all traces as short as possible to reduce the effect of undesirable parasitic inductance. Place input and output capacitors as close as possible to the device (no more than 5mm). IN and OUT pins must be connected with short traces to the power bus.

During normal operation, the power dissipation is small and the package temperature change is minimal. If the output is continuously shorted to ground at the maximum supply voltage, the operation of the switches with the autoretry option does not cause problems because the total power dissipated during the short is scaled by the duty cycle:

$$P_{MAX} = \frac{V_{IN_MAX} \times I_{OUT_MAX} \times t_{BLANK}}{t_{RETRY} + t_{BLANK}} = 302mW$$

where $V_{IN} = 5.5V$, $I_{OUT} = 450mA$, $t_{BLANK} = 14ms$, and $t_{RETRY} = 98ms$.

Attention must be given to the MAX4789, MAX4791, and MAX4793 where the latch-off condition must be manually reset by toggling ON from high to low. If the latch-off time duration is not sufficiently high, it is possible for the device to reach the thermal-shutdown threshold and never be able to turn the device on until it cools down.

Chip Information

PROCESS: BiCMOS

200mA/250mA/300mA Current-Limit Switches

MAX4789-MAX4794

Pin Configurations (continued)

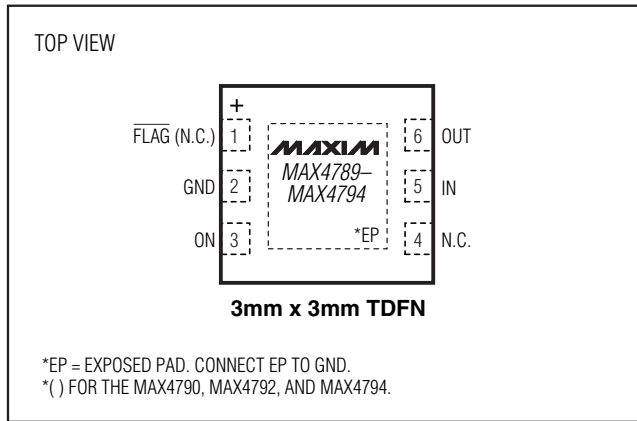

Ordering Information (continued)

PART	TEMP RANGE	PIN-PACKAGE	TOP MARK
MAX4791 EUS+T	-40°C to +85°C	4 SOT143	KAFG
MAX4791EUK+T	-40°C to +85°C	5 SOT23	AEAE
MAX4791EUK/V+T	-40°C to +85°C	5 SOT23-5	AFGJ
MAX4791ETT+	-40°C to +85°C	6 TDFN-EP*	ABQ
MAX4792 EUS+T	-40°C to +85°C	4 SOT143	KAFH
MAX4792ETT+	-40°C to +85°C	6 TDFN-EP*	ABR
MAX4793 EUS+T	-40°C to +85°C	4 SOT143	KAFI
MAX4793EUK+T	-40°C to +85°C	5 SOT23	AEAG
MAX4793ETT+	-40°C to +85°C	6 TDFN-EP*	ABS
MAX4794 EUS+T	-40°C to +85°C	4 SOT143	KAFJ
MAX4794ETT+	-40°C to +85°C	6 TDFN-EP*	ABT

*EP = Exposed paddle.

N denotes an automotive qualified part.

+ Denotes a lead-free/RoHS-compliant package.

Selector Guide

PART	PIN-PACKAGE	CURRENT LIMIT (mA)	FLAG FUNCTION	AUTO-RETRY
MAX4789	4 SOT143	200	No	No
MAX4789	5 SOT23	200	Yes	No
MAX4789	6 TDFN	200	Yes	No
MAX4790	4 SOT143	200	No	Yes
MAX4790	6 TDFN	200	No	Yes
MAX4790	5 SOT23	200	No	Yes
MAX4791	4 SOT143	250	No	No
MAX4791	5 SOT23	250	Yes	No
MAX4791	6 TDFN	250	Yes	No
MAX4792	4 SOT143	250	No	Yes
MAX4792	6 TDFN	250	No	Yes
MAX4793	4 SOT143	300	No	No
MAX4793	5 SOT23	300	Yes	No
MAX4793	6 TDFN	300	Yes	No
MAX4794	4 SOT143	300	No	Yes
MAX4794	6 TDFN	300	No	Yes

200mA/250mA/300mA Current-Limit Switches

Package Information

For the latest package outline information and land patterns, go to www.maxim-ic.com/packages.

PACKAGE TYPE	PACKAGE CODE	DOCUMENT NO.
4 SOT143	U4-2	21-0052
5 SOT23	U5-2	21-0057
6 TDFN-EP	T633-2	21-0137

200mA/250mA/300mA Current-Limit Switches

Revision History

REVISION NUMBER	REVISION DATE	DESCRIPTION	PAGES CHANGED
2	2/05	Changed package description	—
3	10/08	Changed <i>Ordering Information</i> and <i>Package Information</i> .	1, 8–11

MAX4789-MAX4794

Maxim cannot assume responsibility for use of any circuitry other than circuitry entirely embodied in a Maxim product. No circuit patent licenses are implied. Maxim reserves the right to change the circuitry and specifications without notice at any time.

Maxim Integrated Products, 120 San Gabriel Drive, Sunnyvale, CA 94086 408-737-7600 _____ 11

Mouser Electronics

Authorized Distributor

Click to View Pricing, Inventory, Delivery & Lifecycle Information:

[Maxim Integrated:](#)

[MAX4791EUK/V+T](#) [MAX4792EUS+T](#) [MAX4789EUS](#)