

# MC7800, MC7800A, MC7800AE, NCV7800

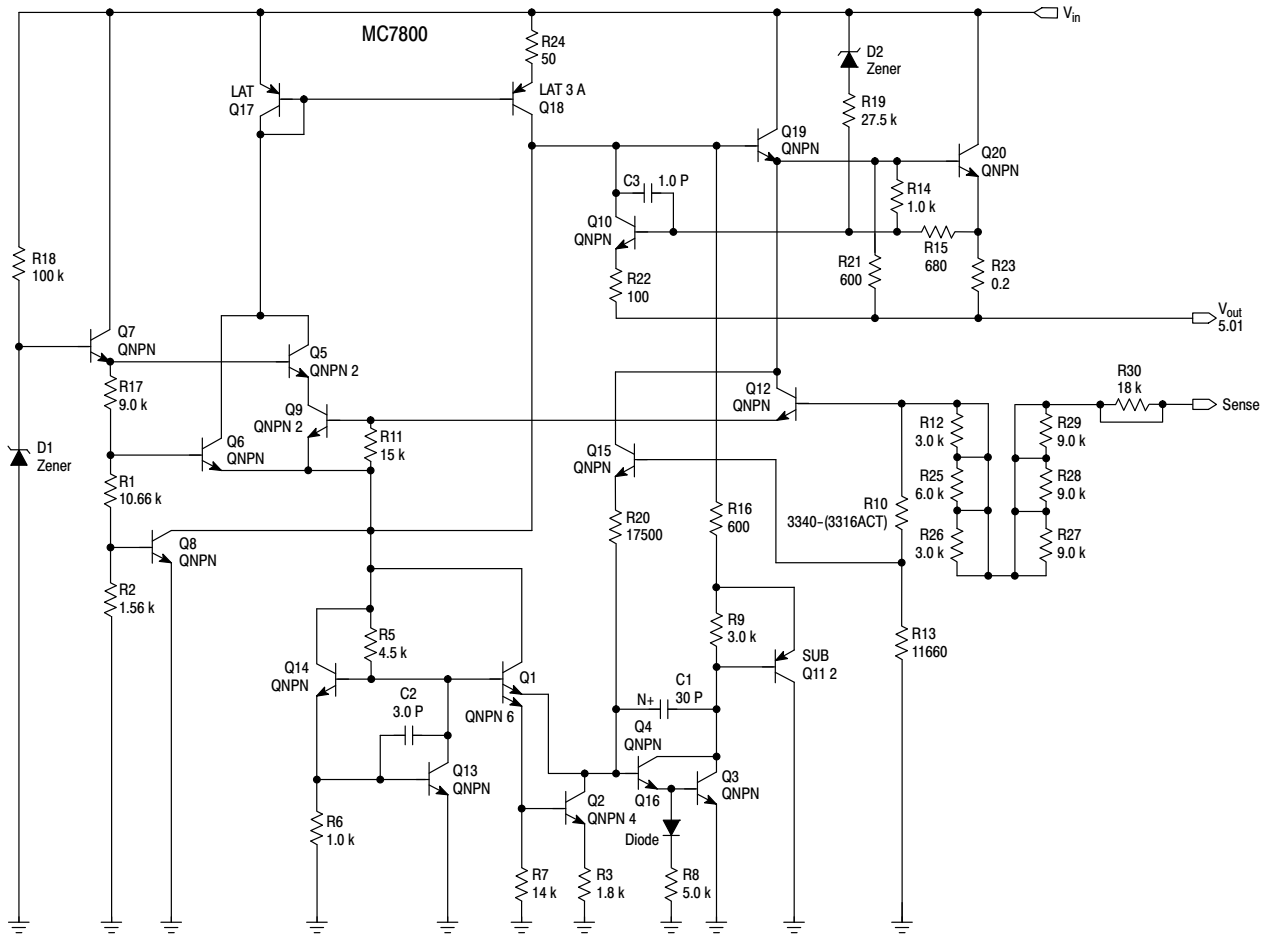

This device contains 22 active transistors.

**Figure 1. Representative Schematic Diagram**

# MC7800, MC7800A, MC7800AE, NCV7800

**ELECTRICAL CHARACTERISTICS** ( $V_{in} = 10\text{ V}$ ,  $I_O = 500\text{ mA}$ ,  $T_J = T_{low}$  to  $125^\circ\text{C}$  (Note 1), unless otherwise noted)

| Characteristic   | Symbol       | MC7805B, NCV7805B |             |           | MC7805C   |             |            | Unit                       |
|--|--------------|-------------------|-------------|-----------|-----------|-------------|------------|----------------------------|
|  |              | Min               | Typ         | Max       | Min       | Typ         | Max        |                            |
| Output Voltage ( $T_J = 25^\circ\text{C}$ )  | $V_O$        | 4.8               | 5.0         | 5.2       | 4.8       | 5.0         | 5.2        | Vdc                        |
| Output Voltage ( $5.0\text{ mA} \leq I_O \leq 1.0\text{ A}$ , $P_D \leq 15\text{ W}$ )<br>$7.0\text{ Vdc} \leq V_{in} \leq 20\text{ Vdc}$<br>$8.0\text{ Vdc} \leq V_{in} \leq 20\text{ Vdc}$ | $V_O$        | –<br>4.75         | –<br>5.0    | –<br>5.25 | 4.75<br>– | 5.0<br>–    | 5.25<br>–  | Vdc                        |
| Line Regulation (Note 4)<br>$7.5\text{ Vdc} \leq V_{in} \leq 20\text{ Vdc}$ , $1.0\text{ A}$<br>$8.0\text{ Vdc} \leq V_{in} \leq 12\text{ Vdc}$  | $Reg_{line}$ | –<br>–            | 5.0<br>1.3  | 100<br>50 | –<br>–    | 0.5<br>0.8  | 20<br>10   | mV                         |
| Load Regulation (Note 4)<br>$5.0\text{ mA} \leq I_O \leq 1.0\text{ A}$<br>$5.0\text{ mA} \leq I_O \leq 1.5\text{ A}$ ( $T_A = 25^\circ\text{C}$ )  | $Reg_{load}$ | –<br>–            | 1.3<br>0.15 | 100<br>50 | –<br>–    | 1.3<br>1.3  | 25<br>25   | mV                         |
| Quiescent Current  | $I_B$        | –                 | 3.2         | 8.0       | –         | 3.2         | 6.5        | mA                         |
| Quiescent Current Change<br>$7.0\text{ Vdc} \leq V_{in} \leq 25\text{ Vdc}$<br>$5.0\text{ mA} \leq I_O \leq 1.0\text{ A}$ ( $T_A = 25^\circ\text{C}$ )                                       | $\Delta I_B$ | –<br>–            | –<br>–      | –<br>0.5  | –<br>–    | 0.3<br>0.08 | 1.0<br>0.8 | mA                         |
| Ripple Rejection<br>$8.0\text{ Vdc} \leq V_{in} \leq 18\text{ Vdc}$ , $f = 120\text{ Hz}$  | RR           | –                 | 68          | –         | 62        | 83          | –          | dB                         |
| Dropout Voltage ( $I_O = 1.0\text{ A}$ , $T_J = 25^\circ\text{C}$ )  | $V_I - V_O$  | –                 | 2.0         | –         | –         | 2.0         | –          | Vdc                        |
| Output Noise Voltage ( $T_A = 25^\circ\text{C}$ )<br>$10\text{ Hz} \leq f \leq 100\text{ kHz}$   | $V_n$        | –                 | 10          | –         | –         | 10          | –          | $\mu\text{V}/V_O$          |
| Output Resistance $f = 1.0\text{ kHz}$   | $r_O$        | –                 | 0.9         | –         | –         | 0.9         | –          | $\text{m}\Omega$           |
| Short Circuit Current Limit ( $T_A = 25^\circ\text{C}$ )<br>$V_{in} = 35\text{ Vdc}$   | $I_{SC}$     | –                 | 0.2         | –         | –         | 0.6         | –          | A                          |
| Peak Output Current ( $T_J = 25^\circ\text{C}$ )   | $I_{max}$    | –                 | 2.2         | –         | –         | 2.2         | –          | A                          |
| Average Temperature Coefficient of Output Voltage  | $TCV_O$      | –                 | –0.3        | –         | –         | –0.3        | –          | $\text{mV}/^\circ\text{C}$ |

- $T_{low} = 0^\circ\text{C}$  for MC78XXC, MC78XXAC,  
 $= -40^\circ\text{C}$  for NCV78XX, MC78XXB, MC78XXAB, and MC78XXAEB
- Load and line regulation are specified at constant junction temperature. Changes in  $V_O$  due to heating effects must be taken into account separately. Pulse testing with low duty cycle is used.

# MC7800, MC7800A, MC7800AE, NCV7800

## ELECTRICAL CHARACTERISTICS ( $V_{in} = 10\text{ V}$ , $I_O = 1.0\text{ A}$ , $T_J = T_{low}$ to $125^\circ\text{C}$ (Note 3), unless otherwise noted)

| Characteristic  | Symbol       | MC7805AB/MC7805AC/NCV7805AB |                          |                       | Unit                       |
|---|--------------|-----------------------------|--------------------------|-----------------------|----------------------------|
|   |              | Min                         | Typ                      | Max                   |                            |
| Output Voltage ( $T_J = 25^\circ\text{C}$ )   | $V_O$        | 4.9                         | 5.0                      | 5.1                   | Vdc                        |
| Output Voltage ( $5.0\text{ mA} \leq I_O \leq 1.0\text{ A}$ , $P_D \leq 15\text{ W}$ )<br>$7.5\text{ Vdc} \leq V_{in} \leq 20\text{ Vdc}$   | $V_O$        | 4.8                         | 5.0                      | 5.2                   | Vdc                        |
| Line Regulation (Note 4)<br>$7.5\text{ Vdc} \leq V_{in} \leq 25\text{ Vdc}$ , $I_O = 500\text{ mA}$<br>$8.0\text{ Vdc} \leq V_{in} \leq 12\text{ Vdc}$ , $I_O = 1.0\text{ A}$<br>$8.0\text{ Vdc} \leq V_{in} \leq 12\text{ Vdc}$ , $I_O = 1.0\text{ A}$ , $T_J = 25^\circ\text{C}$<br>$7.3\text{ Vdc} \leq V_{in} \leq 20\text{ Vdc}$ , $I_O = 1.0\text{ A}$ , $T_J = 25^\circ\text{C}$ | $Reg_{line}$ | –                           | 0.5<br>0.8<br>1.3<br>4.5 | 10<br>12<br>4.0<br>10 | mV                         |
| Load Regulation (Note 4)<br>$5.0\text{ mA} \leq I_O \leq 1.5\text{ A}$ , $T_J = 25^\circ\text{C}$<br>$5.0\text{ mA} \leq I_O \leq 1.0\text{ A}$<br>$250\text{ mA} \leq I_O \leq 750\text{ mA}$  | $Reg_{load}$ | –                           | 1.3<br>0.8<br>0.53       | 25<br>25<br>15        | mV                         |
| Quiescent Current   | $I_B$        | –                           | 3.2                      | 6.0                   | mA                         |
| Quiescent Current Change<br>$8.0\text{ Vdc} \leq V_{in} \leq 25\text{ Vdc}$ , $I_O = 500\text{ mA}$<br>$7.5\text{ Vdc} \leq V_{in} \leq 20\text{ Vdc}$ , $T_J = 25^\circ\text{C}$<br>$5.0\text{ mA} \leq I_O \leq 1.0\text{ A}$   | $\Delta I_B$ | –                           | 0.3<br>–<br>0.08         | 0.8<br>0.8<br>0.5     | mA                         |
| Ripple Rejection<br>$8.0\text{ Vdc} \leq V_{in} \leq 18\text{ Vdc}$ , $f = 120\text{ Hz}$ , $I_O = 500\text{ mA}$   | RR           | 68                          | 83                       | –                     | dB                         |
| Dropout Voltage ( $I_O = 1.0\text{ A}$ , $T_J = 25^\circ\text{C}$ )   | $V_I - V_O$  | –                           | 2.0                      | –                     | Vdc                        |
| Output Noise Voltage ( $T_A = 25^\circ\text{C}$ )<br>$10\text{ Hz} \leq f \leq 100\text{ kHz}$  | $V_n$        | –                           | 10                       | –                     | $\mu\text{V}/V_O$          |
| Output Resistance ( $f = 1.0\text{ kHz}$ )  | $r_O$        | –                           | 0.9                      | –                     | $\text{m}\Omega$           |
| Short Circuit Current Limit ( $T_A = 25^\circ\text{C}$ )<br>$V_{in} = 35\text{ Vdc}$  | $I_{SC}$     | –                           | 0.2                      | –                     | A                          |
| Peak Output Current ( $T_J = 25^\circ\text{C}$ )  | $I_{max}$    | –                           | 2.2                      | –                     | A                          |
| Average Temperature Coefficient of Output Voltage   | $TCV_O$      | –                           | –0.3                     | –                     | $\text{mV}/^\circ\text{C}$ |

3.  $T_{low} = 0^\circ\text{C}$  for MC78XXC, MC78XXAC,

=  $-40^\circ\text{C}$  for NCV78XX, MC78XXB, MC78XXAB, and MC78XXAEB

4. Load and line regulation are specified at constant junction temperature. Changes in  $V_O$  due to heating effects must be taken into account separately. Pulse testing with low duty cycle is used.

## MC7800, MC7800A, MC7800AE, NCV7800

**ELECTRICAL CHARACTERISTICS** ( $V_{in} = 14\text{ V}$ ,  $I_O = 500\text{ mA}$ ,  $T_J = T_{low}$  to  $125^\circ\text{C}$  (Note 5), unless otherwise noted)

| Characteristic   | Symbol              | MC7808B/NCV7808B |            |           | MC7808C  |            |            | Unit                       |
|--|---------------------|------------------|------------|-----------|----------|------------|------------|----------------------------|
|  |                     | Min              | Typ        | Max       | Min      | Typ        | Max        |                            |
| Output Voltage ( $T_J = 25^\circ\text{C}$ )  | $V_O$               | 7.7              | 8.0        | 8.3       | 7.7      | 8.0        | 8.3        | Vdc                        |
| Output Voltage ( $5.0\text{ mA} \leq I_O \leq 1.0\text{ A}$ , $P_D \leq 15\text{ W}$ )<br>$10.5\text{ Vdc} \leq V_{in} \leq 23\text{ Vdc}$<br>$11.5\text{ Vdc} \leq V_{in} \leq 23\text{ Vdc}$ | $V_O$               | –<br>7.6         | –<br>8.0   | –<br>8.4  | 7.6<br>– | 8.0<br>–   | 8.4<br>–   | Vdc                        |
| Line Regulation, $T_J = 25^\circ\text{C}$ , (Note 6)<br>$10.5\text{ Vdc} \leq V_{in} \leq 25\text{ Vdc}$<br>$11\text{ Vdc} \leq V_{in} \leq 17\text{ Vdc}$                                     | $\text{Reg}_{line}$ | –<br>–           | 6.0<br>1.7 | 160<br>80 | –<br>–   | 6.0<br>1.7 | 32<br>16   | mV                         |
| Load Regulation, $T_J = 25^\circ\text{C}$ (Note 6)<br>$5.0\text{ mA} \leq I_O \leq 1.5\text{ A}$   | $\text{Reg}_{load}$ | –                | 1.4        | 160       | –        | 1.4        | 35         | mV                         |
| Quiescent Current  | $I_B$               | –                | 3.3        | 8.0       | –        | 3.3        | 8.0        | mA                         |
| Quiescent Current Change<br>$10.5\text{ Vdc} \leq V_{in} \leq 25\text{ Vdc}$<br>$5.0\text{ mA} \leq I_O \leq 1.0\text{ A}$   | $\Delta I_B$        | –<br>–           | –<br>–     | –<br>0.5  | –<br>–   | –<br>–     | 1.0<br>0.5 | mA                         |
| Ripple Rejection<br>$11.5\text{ Vdc} \leq V_{in} \leq 18\text{ Vdc}$ , $f = 120\text{ Hz}$   | RR                  | –                | 62         | –         | 56       | 62         | –          | dB                         |
| Dropout Voltage ( $I_O = 1.0\text{ A}$ , $T_J = 25^\circ\text{C}$ )  | $V_I - V_O$         | –                | 2.0        | –         | –        | 2.0        | –          | Vdc                        |
| Output Noise Voltage ( $T_A = 25^\circ\text{C}$ )<br>$10\text{ Hz} \leq f \leq 100\text{ kHz}$   | $V_n$               | –                | 10         | –         | –        | 10         | –          | $\mu\text{V}/V_O$          |
| Output Resistance $f = 1.0\text{ kHz}$   | $r_O$               | –                | 0.9        | –         | –        | 0.9        | –          | $\text{m}\Omega$           |
| Short Circuit Current Limit ( $T_A = 25^\circ\text{C}$ )<br>$V_{in} = 35\text{ Vdc}$   | $I_{SC}$            | –                | 0.2        | –         | –        | 0.2        | –          | A                          |
| Peak Output Current ( $T_J = 25^\circ\text{C}$ )   | $I_{max}$           | –                | 2.2        | –         | –        | 2.2        | –          | A                          |
| Average Temperature Coefficient of Output Voltage  | $\text{TCV}_O$      | –                | –0.4       | –         | –        | –0.4       | –          | $\text{mV}/^\circ\text{C}$ |

5.  $T_{low} = 0^\circ\text{C}$  for MC78XXC, MC78XXAC,  
=  $-40^\circ\text{C}$  for NCV78XX, MC78XXB, MC78XXAB, and MC78XXAEB
6. Load and line regulation are specified at constant junction temperature. Changes in  $V_O$  due to heating effects must be taken into account separately. Pulse testing with low duty cycle is used.

# MC7800, MC7800A, MC7800AE, NCV7800

## ELECTRICAL CHARACTERISTICS ( $V_{in} = 14\text{ V}$ , $I_O = 1.0\text{ A}$ , $T_J = T_{low}$ to $125^\circ\text{C}$ (Note 7), unless otherwise noted)

| Characteristic   | Symbol              | MC7808AB/MC7808AC/NCV7808AB |                    |                   | Unit                       |
|--|---------------------|-----------------------------|--------------------|-------------------|----------------------------|
|  |                     | Min                         | Typ                | Max               |                            |
| Output Voltage ( $T_J = 25^\circ\text{C}$ )  | $V_O$               | 7.84                        | 8.0                | 8.16              | Vdc                        |
| Output Voltage ( $5.0\text{ mA} \leq I_O \leq 1.0\text{ A}$ , $P_D \leq 15\text{ W}$ )<br>$10.6\text{ Vdc} \leq V_{in} \leq 23\text{ Vdc}$   | $V_O$               | 7.7                         | 8.0                | 8.3               | Vdc                        |
| Line Regulation (Note 8)<br>$10.6\text{ Vdc} \leq V_{in} \leq 25\text{ Vdc}$ , $I_O = 500\text{ mA}$<br>$11\text{ Vdc} \leq V_{in} \leq 17\text{ Vdc}$ , $I_O = 1.0\text{ A}$<br>$10.4\text{ Vdc} \leq V_{in} \leq 23\text{ Vdc}$ , $T_J = 25^\circ\text{C}$ | $\text{Reg}_{line}$ | –                           | 6.0<br>1.7<br>5.0  | 15<br>18<br>15    | mV                         |
| Load Regulation (Note 8)<br>$5.0\text{ mA} \leq I_O \leq 1.5\text{ A}$ , $T_J = 25^\circ\text{C}$<br>$5.0\text{ mA} \leq I_O \leq 1.0\text{ A}$<br>$250\text{ mA} \leq I_O \leq 750\text{ mA}$   | $\text{Reg}_{load}$ | –                           | 1.4<br>1.0<br>0.22 | 25<br>25<br>15    | mV                         |
| Quiescent Current  | $I_B$               | –                           | 3.3                | 6.0               | mA                         |
| Quiescent Current Change<br>$11\text{ Vdc} \leq V_{in} \leq 25\text{ Vdc}$ , $I_O = 500\text{ mA}$<br>$10.6\text{ Vdc} \leq V_{in} \leq 23\text{ Vdc}$ , $I_O = 1.0\text{ A}$ , $T_J = 25^\circ\text{C}$<br>$5.0\text{ mA} \leq I_O \leq 1.0\text{ A}$       | $\Delta I_B$        | –                           | –                  | 0.8<br>0.8<br>0.5 | mA                         |
| Ripple Rejection<br>$11.5\text{ Vdc} \leq V_{in} \leq 21.5\text{ Vdc}$ , $f = 120\text{ Hz}$ , $I_O = 500\text{ mA}$   | RR                  | 56                          | 62                 | –                 | dB                         |
| Dropout Voltage ( $I_O = 1.0\text{ A}$ , $T_J = 25^\circ\text{C}$ )  | $V_I - V_O$         | –                           | 2.0                | –                 | Vdc                        |
| Output Noise Voltage ( $T_A = 25^\circ\text{C}$ )<br>$10\text{ Hz} \leq f \leq 100\text{ kHz}$   | $V_n$               | –                           | 10                 | –                 | $\mu\text{V}/V_O$          |
| Output Resistance $f = 1.0\text{ kHz}$   | $r_O$               | –                           | 0.9                | –                 | $\text{m}\Omega$           |
| Short Circuit Current Limit ( $T_A = 25^\circ\text{C}$ )<br>$V_{in} = 35\text{ Vdc}$   | $I_{SC}$            | –                           | 0.2                | –                 | A                          |
| Peak Output Current ( $T_J = 25^\circ\text{C}$ )   | $I_{max}$           | –                           | 2.2                | –                 | A                          |
| Average Temperature Coefficient of Output Voltage  | $\text{TCV}_O$      | –                           | –0.4               | –                 | $\text{mV}/^\circ\text{C}$ |

7.  $T_{low} = 0^\circ\text{C}$  for MC78XXC, MC78XXAC,

=  $-40^\circ\text{C}$  for NCV78XX, MC78XXB, MC78XXAB, and MC78XXAEB

8. Load and line regulation are specified at constant junction temperature. Changes in  $V_O$  due to heating effects must be taken into account separately. Pulse testing with low duty cycle is used.

## MC7800, MC7800A, MC7800AE, NCV7800

**ELECTRICAL CHARACTERISTICS** ( $V_{in} = 15\text{ V}$ ,  $I_O = 500\text{ mA}$ ,  $T_J = T_{low}$  to  $125^\circ\text{C}$  (Note 9), unless otherwise noted)

| Characteristic  | Symbol              | MC7809B/NCV7809B |      |      | MC7809C |      |      | Unit                       |
|---|---------------------|------------------|------|------|---------|------|------|----------------------------|
|   |                     | Min              | Typ  | Max  | Min     | Typ  | Max  |                            |
| Output Voltage ( $T_J = 25^\circ\text{C}$ )   | $V_O$               | 8.65             | 9.0  | 9.35 | 8.65    | 9.0  | 9.35 | Vdc                        |
| Output Voltage ( $5.0\text{ mA} \leq I_O \leq 1.0\text{ A}$ , $P_D \leq 15\text{ W}$ )<br>$11.5\text{ Vdc} \leq V_{in} \leq 24\text{ Vdc}$                | $V_O$               | 8.55             | 9.0  | 9.45 | 8.55    | 9.0  | 9.45 | Vdc                        |
| Line Regulation, $T_J = 25^\circ\text{C}$ (Note 10)<br>$11\text{ Vdc} \leq V_{in} \leq 26\text{ Vdc}$<br>$11.5\text{ Vdc} \leq V_{in} \leq 17\text{ Vdc}$ | $\text{Reg}_{line}$ | –                | 6.2  | 32   | –       | 6.2  | 32   | mV                         |
| Load Regulation, $T_J = 25^\circ\text{C}$ (Note 10)<br>$5.0\text{ mA} \leq I_O \leq 1.5\text{ A}$   | $\text{Reg}_{load}$ | –                | 1.5  | 35   | –       | 1.5  | 35   | mV                         |
| Quiescent Current   | $I_B$               | –                | 3.4  | 8.0  | –       | 3.4  | 8.0  | mA                         |
| Quiescent Current Change<br>$11.5\text{ Vdc} \leq V_{in} \leq 26\text{ Vdc}$<br>$5.0\text{ mA} \leq I_O \leq 1.0\text{ A}$                                | $\Delta I_B$        | –                | –    | 1.0  | –       | –    | 1.0  | mA                         |
| Ripple Rejection<br>$11.5\text{ Vdc} \leq V_{in} \leq 21.5\text{ Vdc}$ , $f = 120\text{ Hz}$  | RR                  | 56               | 61   | –    | 56      | 61   | –    | dB                         |
| Dropout Voltage ( $I_O = 1.0\text{ A}$ , $T_J = 25^\circ\text{C}$ )   | $V_I - V_O$         | –                | 2.0  | –    | –       | 2.0  | –    | Vdc                        |
| Output Noise Voltage ( $T_A = 25^\circ\text{C}$ )<br>$10\text{ Hz} \leq f \leq 100\text{ kHz}$  | $V_n$               | –                | 10   | –    | –       | 10   | –    | $\mu\text{V}/V_O$          |
| Output Resistance $f = 1.0\text{ kHz}$  | $r_O$               | –                | 1.0  | –    | –       | 1.0  | –    | $\text{m}\Omega$           |
| Short Circuit Current Limit ( $T_A = 25^\circ\text{C}$ )<br>$V_{in} = 35\text{ Vdc}$  | $I_{SC}$            | –                | 0.2  | –    | –       | 0.2  | –    | A                          |
| Peak Output Current ( $T_J = 25^\circ\text{C}$ )  | $I_{max}$           | –                | 2.2  | –    | –       | 2.2  | –    | A                          |
| Average Temperature Coefficient of Output Voltage   | $\text{TCV}_O$      | –                | –0.5 | –    | –       | –0.5 | –    | $\text{mV}/^\circ\text{C}$ |

9.  $T_{low} = 0^\circ\text{C}$  for MC78XXC, MC78XXAC,  
 $= -40^\circ\text{C}$  for NCV78XX, MC78XXB, MC78XXAB, and MC78XXAEB

10. Load and line regulation are specified at constant junction temperature. Changes in  $V_O$  due to heating effects must be taken into account separately. Pulse testing with low duty cycle is used.

# MC7800, MC7800A, MC7800AE, NCV7800

## ELECTRICAL CHARACTERISTICS ( $V_{in} = 15\text{ V}$ , $I_O = 1.0\text{ A}$ , $T_J = T_{low}$ to $125^\circ\text{C}$ (Note 11), unless otherwise noted)

| Characteristic  | Symbol       | MC7809AB/MC7809AC |                   |                   | Unit                       |
|---|--------------|-------------------|-------------------|-------------------|----------------------------|
|   |              | Min               | Typ               | Max               |                            |
| Output Voltage ( $T_J = 25^\circ\text{C}$ )   | $V_O$        | 8.82              | 9.0               | 9.18              | Vdc                        |
| Output Voltage ( $5.0\text{ mA} \leq I_O \leq 1.0\text{ A}$ , $P_D \leq 15\text{ W}$ )<br>$11.5\text{ Vdc} \leq V_{in} \leq 24\text{ Vdc}$  | $V_O$        | 8.65              | 9.0               | 9.35              | Vdc                        |
| Line Regulation (Note 12)<br>$11.5\text{ Vdc} \leq V_{in} \leq 26\text{ Vdc}$ , $I_O = 500\text{ mA}$<br>$12\text{ Vdc} \leq V_{in} \leq 17\text{ Vdc}$ , $I_O = 1.0\text{ A}$<br>$11.5\text{ Vdc} \leq V_{in} \leq 24\text{ Vdc}$ , $T_J = 25^\circ\text{C}$ | Regline      | –                 | 6.2<br>1.8<br>5.2 | 16<br>7.0<br>16   | mV                         |
| Load Regulation (Note 12)<br>$5.0\text{ mA} \leq I_O \leq 1.5\text{ A}$ , $T_J = 25^\circ\text{C}$<br>$5.0\text{ mA} \leq I_O \leq 1.0\text{ A}$<br>$250\text{ mA} \leq I_O \leq 750\text{ mA}$   | Regload      | –                 | –                 | 25<br>25<br>15    | mV                         |
| Quiescent Current   | $I_B$        | –                 | 3.3               | 6.0               | mA                         |
| Quiescent Current Change<br>$11.5\text{ Vdc} \leq V_{in} \leq 26\text{ Vdc}$ , $I_O = 500\text{ mA}$<br>$11.5\text{ Vdc} \leq V_{in} \leq 24\text{ Vdc}$ , $I_O = 1.0\text{ A}$ , $T_J = 25^\circ\text{C}$<br>$5.0\text{ mA} \leq I_O \leq 1.0\text{ A}$      | $\Delta I_B$ | –                 | –                 | 0.8<br>0.8<br>0.5 | mA                         |
| Ripple Rejection<br>$11.5\text{ Vdc} \leq V_{in} \leq 21.5\text{ Vdc}$ , $f = 120\text{ Hz}$ , $I_O = 500\text{ mA}$  | RR           | 56                | 61                | –                 | dB                         |
| Dropout Voltage ( $I_O = 1.0\text{ A}$ , $T_J = 25^\circ\text{C}$ )   | $V_{I\_VO}$  |                   | 2.0               |                   | Vdc                        |
| Output Noise Voltage ( $T_A = 25^\circ\text{C}$ )<br>$10\text{ Hz} \leq f \leq 100\text{ kHz}$  | $V_n$        | –                 | 10                | –                 | $\mu\text{V}/V_O$          |
| Output Resistance $f = 1.0\text{ kHz}$  | $r_O$        | –                 | 1.0               | –                 | $\text{m}\Omega$           |
| Short Circuit Current Limit ( $T_A = 25^\circ\text{C}$ )<br>$V_{in} = 35\text{ Vdc}$  | $I_{SC}$     | –                 | 0.2               | –                 | A                          |
| Peak Output Current ( $T_J = 25^\circ\text{C}$ )  | $I_{max}$    | –                 | 2.2               | –                 | A                          |
| Average Temperature Coefficient of Output Voltage   | TCVO         | –                 | –0.5              | –                 | $\text{mV}/^\circ\text{C}$ |

11.  $T_{low} = 0^\circ\text{C}$  for MC78XXC, MC78XXAC,  
=  $-40^\circ\text{C}$  for NCV78XX, MC78XXB, MC78XXAB.

12. Load and line regulation are specified at constant junction temperature. Changes in  $V_O$  due to heating effects must be taken into account separately. Pulse testing with low duty cycle is used.

# MC7800, MC7800A, MC7800AE, NCV7800

**ELECTRICAL CHARACTERISTICS** ( $V_{in} = 19\text{ V}$ ,  $I_O = 500\text{ mA}$ ,  $T_J = T_{low}$  to  $125^\circ\text{C}$  (Note 13), unless otherwise noted)

| Characteristic   | Symbol       | MC7812B/NCV7812B |                 |                 | MC7812C     |                 |                   | Unit                       |
|--|--------------|------------------|-----------------|-----------------|-------------|-----------------|-------------------|----------------------------|
|  |              | Min              | Typ             | Max             | Min         | Typ             | Max               |                            |
| Output Voltage ( $T_J = 25^\circ\text{C}$ )  | $V_O$        | 11.5             | 12              | 12.5            | 11.5        | 12              | 12.5              | Vdc                        |
| Output Voltage ( $5.0\text{ mA} \leq I_O \leq 1.0\text{ A}$ , $P_D \leq 15\text{ W}$ )<br>$14.5\text{ Vdc} \leq V_{in} \leq 27\text{ Vdc}$<br>$15.5\text{ Vdc} \leq V_{in} \leq 27\text{ Vdc}$                                       | $V_O$        | –<br>11.4        | –<br>12         | –<br>12.6       | 11.4<br>–   | 12<br>–         | 12.6<br>–         | Vdc                        |
| Line Regulation, $T_J = 25^\circ\text{C}$ (Note 14)<br>$14.5\text{ Vdc} \leq V_{in} \leq 30\text{ Vdc}$<br>$16\text{ Vdc} \leq V_{in} \leq 22\text{ Vdc}$<br>$14.8\text{ Vdc} \leq V_{in} \leq 27\text{ Vdc}$ , $I_O = 1.0\text{ A}$ | $Reg_{line}$ | –<br>–<br>–      | 7.5<br>2.2<br>– | 240<br>120<br>– | –<br>–<br>– | 3.8<br>0.3<br>– | 24<br>24<br>48    | mV                         |
| Load Regulation, $T_J = 25^\circ\text{C}$ (Note 14)<br>$5.0\text{ mA} \leq I_O \leq 1.5\text{ A}$  | $Reg_{load}$ | –                | 1.6             | 240             | –           | 8.1             | 60                | mV                         |
| Quiescent Current  | $I_B$        | –                | 3.4             | 8.0             | –           | 3.4             | 6.5               | mA                         |
| Quiescent Current Change<br>$14.5\text{ Vdc} \leq V_{in} \leq 30\text{ Vdc}$ , $I_O = 1.0\text{ A}$ , $T_J = 25^\circ\text{C}$<br>$15\text{ Vdc} \leq V_{in} \leq 30\text{ Vdc}$<br>$5.0\text{ mA} \leq I_O \leq 1.0\text{ A}$       | $\Delta I_B$ | –<br>–<br>–      | –<br>–<br>–     | –<br>1.0<br>0.5 | –<br>–<br>– | –<br>–<br>–     | 0.7<br>0.8<br>0.5 | mA                         |
| Ripple Rejection<br>$15\text{ Vdc} \leq V_{in} \leq 25\text{ Vdc}$ , $f = 120\text{ Hz}$   | RR           | –                | 60              | –               | 55          | 60              | –                 | dB                         |
| Dropout Voltage ( $I_O = 1.0\text{ A}$ , $T_J = 25^\circ\text{C}$ )  | $V_I - V_O$  | –                | 2.0             | –               | –           | 2.0             | –                 | Vdc                        |
| Output Noise Voltage ( $T_A = 25^\circ\text{C}$ )<br>$10\text{ Hz} \leq f \leq 100\text{ kHz}$   | $V_n$        | –                | 10              | –               | –           | 10              | –                 | $\mu\text{V}/V_O$          |
| Output Resistance $f = 1.0\text{ kHz}$   | $r_O$        | –                | 1.1             | –               | –           | 1.1             | –                 | $\text{m}\Omega$           |
| Short Circuit Current Limit ( $T_A = 25^\circ\text{C}$ )<br>$V_{in} = 35\text{ Vdc}$   | $I_{SC}$     | –                | 0.2             | –               | –           | 0.2             | –                 | A                          |
| Peak Output Current ( $T_J = 25^\circ\text{C}$ )   | $I_{max}$    | –                | 2.2             | –               | –           | 2.2             | –                 | A                          |
| Average Temperature Coefficient of Output Voltage  | $TCV_O$      | –                | –0.8            | –               | –           | –0.8            | –                 | $\text{mV}/^\circ\text{C}$ |

13.  $T_{low} = 0^\circ\text{C}$  for MC78XXC, MC78XXAC,  
 $= -40^\circ\text{C}$  for NCV78XX, MC78XXB, MC78XXAB, and MC78XXAEB

14. Load and line regulation are specified at constant junction temperature. Changes in  $V_O$  due to heating effects must be taken into account separately. Pulse testing with low duty cycle is used.



# MC7800, MC7800A, MC7800AE, NCV7800

## ELECTRICAL CHARACTERISTICS ( $V_{in} = 19\text{ V}$ , $I_O = 1.0\text{ A}$ , $T_J = T_{low}$ to $125^\circ\text{C}$ (Note 15), unless otherwise noted)

| Characteristic  | Symbol       | MC7812AB/MC7812AC/NCV7812AB |                   |                   | Unit                       |
|---|--------------|-----------------------------|-------------------|-------------------|----------------------------|
|   |              | Min                         | Typ               | Max               |                            |
| Output Voltage ( $T_J = 25^\circ\text{C}$ )   | $V_O$        | 11.75                       | 12                | 12.25             | Vdc                        |
| Output Voltage ( $5.0\text{ mA} \leq I_O \leq 1.0\text{ A}$ , $P_D \leq 15\text{ W}$ )<br>$14.8\text{ Vdc} \leq V_{in} \leq 27\text{ Vdc}$  | $V_O$        | 11.5                        | 12                | 12.5              | Vdc                        |
| Line Regulation (Note 16)<br>$14.8\text{ Vdc} \leq V_{in} \leq 30\text{ Vdc}$ , $I_O = 500\text{ mA}$<br>$16\text{ Vdc} \leq V_{in} \leq 22\text{ Vdc}$ , $I_O = 1.0\text{ A}$<br>$14.5\text{ Vdc} \leq V_{in} \leq 27\text{ Vdc}$ , $T_J = 25^\circ\text{C}$ | $Reg_{line}$ | –                           | 3.8<br>2.2<br>6.0 | 18<br>20<br>120   | mV                         |
| Load Regulation (Note 16)<br>$5.0\text{ mA} \leq I_O \leq 1.5\text{ A}$ , $T_J = 25^\circ\text{C}$<br>$5.0\text{ mA} \leq I_O \leq 1.0\text{ A}$  | $Reg_{load}$ | –                           | –                 | 25<br>25          | mV                         |
| Quiescent Current   | $I_B$        | –                           | 3.4               | 6.0               | mA                         |
| Quiescent Current Change<br>$15\text{ Vdc} \leq V_{in} \leq 30\text{ Vdc}$ , $I_O = 500\text{ mA}$<br>$14.8\text{ Vdc} \leq V_{in} \leq 27\text{ Vdc}$ , $T_J = 25^\circ\text{C}$<br>$5.0\text{ mA} \leq I_O \leq 1.0\text{ A}$ , $T_J = 25^\circ\text{C}$    | $\Delta I_B$ | –                           | –                 | 0.8<br>0.8<br>0.5 | mA                         |
| Ripple Rejection<br>$15\text{ Vdc} \leq V_{in} \leq 25\text{ Vdc}$ , $f = 120\text{ Hz}$ , $I_O = 500\text{ mA}$  | RR           | 55                          | 60                | –                 | dB                         |
| Dropout Voltage ( $I_O = 1.0\text{ A}$ , $T_J = 25^\circ\text{C}$ )   | $V_I - V_O$  | –                           | 2.0               | –                 | Vdc                        |
| Output Noise Voltage ( $T_A = 25^\circ\text{C}$ )<br>$10\text{ Hz} \leq f \leq 100\text{ kHz}$  | $V_n$        | –                           | 10                | –                 | $\mu\text{V}/V_O$          |
| Output Resistance ( $f = 1.0\text{ kHz}$ )  | $r_O$        | –                           | 1.1               | –                 | $\text{m}\Omega$           |
| Short Circuit Current Limit ( $T_A = 25^\circ\text{C}$ )<br>$V_{in} = 35\text{ Vdc}$  | $I_{sc}$     | –                           | 0.2               | –                 | A                          |
| Peak Output Current ( $T_J = 25^\circ\text{C}$ )  | $I_{max}$    | –                           | 2.2               | –                 | A                          |
| Average Temperature Coefficient of Output Voltage   | $TCV_O$      | –                           | –0.8              | –                 | $\text{mV}/^\circ\text{C}$ |

15.  $T_{low} = 0^\circ\text{C}$  for MC78XXC, MC78XXAC,  
=  $-40^\circ\text{C}$  for NCV78XX, MC78XXB, MC78XXAB, and MC78XXAEB

16. Load and line regulation are specified at constant junction temperature. Changes in  $V_O$  due to heating effects must be taken into account separately. Pulse testing with low duty cycle is used.

# MC7800, MC7800A, MC7800AE, NCV7800

**ELECTRICAL CHARACTERISTICS** ( $V_{in} = 23\text{ V}$ ,  $I_O = 500\text{ mA}$ ,  $T_J = T_{low}$  to  $125^\circ\text{C}$  (Note 17), unless otherwise noted)

| Characteristic   | Symbol              | MC7815B/NCV7815B |             |                 | MC7815C     |             |                   | Unit                       |
|--|---------------------|------------------|-------------|-----------------|-------------|-------------|-------------------|----------------------------|
|  |                     | Min              | Typ         | Max             | Min         | Typ         | Max               |                            |
| Output Voltage ( $T_J = 25^\circ\text{C}$ )  | $V_O$               | 14.4             | 15          | 15.6            | 14.4        | 15          | 15.6              | Vdc                        |
| Output Voltage ( $5.0\text{ mA} \leq I_O \leq 1.0\text{ A}$ , $P_D \leq 15\text{ W}$ )<br>$17.5\text{ Vdc} \leq V_{in} \leq 30\text{ Vdc}$<br>$18.5\text{ Vdc} \leq V_{in} \leq 30\text{ Vdc}$                                   | $V_O$               | –<br>14.25       | –<br>15     | –<br>15.75      | 14.25<br>–  | 15<br>–     | 15.75<br>–        | Vdc                        |
| Line Regulation, $T_J = 25^\circ\text{C}$ (Note 18)<br>$17.9\text{ Vdc} \leq V_{in} \leq 30\text{ Vdc}$<br>$20\text{ Vdc} \leq V_{in} \leq 26\text{ Vdc}$  | $\text{Reg}_{line}$ | –<br>–           | 8.5<br>3.0  | 300<br>150      | –<br>–      | 8.5<br>3.0  | 30<br>28          | mV                         |
| Load Regulation, $T_J = 25^\circ\text{C}$ (Note 18)<br>$5.0\text{ mA} \leq I_O \leq 1.5\text{ A}$  | $\text{Reg}_{load}$ | –                | 1.8         | 300             | –           | 1.8         | 55                | mV                         |
| Quiescent Current  | $I_B$               | –                | 3.5         | 8.0             | –           | 3.5         | 6.5               | mA                         |
| Quiescent Current Change<br>$17.5\text{ Vdc} \leq V_{in} \leq 30\text{ Vdc}$<br>$17.5\text{ Vdc} \leq V_{in} \leq 30\text{ Vdc}$ , $I_O = 1.0\text{ A}$ , $T_J = 25^\circ\text{C}$<br>$5.0\text{ mA} \leq I_O \leq 1.0\text{ A}$ | $\Delta I_B$        | –<br>–<br>–      | –<br>–<br>– | –<br>1.0<br>0.5 | –<br>–<br>– | –<br>–<br>– | 0.8<br>0.7<br>0.5 | mA                         |
| Ripple Rejection<br>$18.5\text{ Vdc} \leq V_{in} \leq 28.5\text{ Vdc}$ , $f = 120\text{ Hz}$   | RR                  | –                | 58          | –               | 54          | 58          | –                 | dB                         |
| Dropout Voltage ( $I_O = 1.0\text{ A}$ , $T_J = 25^\circ\text{C}$ )  | $V_I - V_O$         | –                | 2.0         | –               | –           | 2.0         | –                 | Vdc                        |
| Output Noise Voltage ( $T_A = 25^\circ\text{C}$ )<br>$10\text{ Hz} \leq f \leq 100\text{ kHz}$   | $V_n$               | –                | 10          | –               | –           | 10          | –                 | $\mu\text{V}/V_O$          |
| Output Resistance $f = 1.0\text{ kHz}$   | $r_O$               | –                | 1.2         | –               | –           | 1.2         | –                 | $\text{m}\Omega$           |
| Short Circuit Current Limit ( $T_A = 25^\circ\text{C}$ )<br>$V_{in} = 35\text{ Vdc}$   | $I_{SC}$            | –                | 0.2         | –               | –           | 0.2         | –                 | A                          |
| Peak Output Current ( $T_J = 25^\circ\text{C}$ )   | $I_{max}$           | –                | 2.2         | –               | –           | 2.2         | –                 | A                          |
| Average Temperature Coefficient of Output Voltage  | $\text{TCV}_O$      | –                | –1.0        | –               | –           | –1.0        | –                 | $\text{mV}/^\circ\text{C}$ |

17.  $T_{low} = 0^\circ\text{C}$  for MC78XXC, MC78XXAC,  
=  $-40^\circ\text{C}$  for NCV78XX, MC78XXB, MC78XXAB, and MC78XXAEB

18. Load and line regulation are specified at constant junction temperature. Changes in  $V_O$  due to heating effects must be taken into account separately. Pulse testing with low duty cycle is used.

# MC7800, MC7800A, MC7800AE, NCV7800

## ELECTRICAL CHARACTERISTICS ( $V_{in} = 23\text{ V}$ , $I_O = 1.0\text{ A}$ , $T_J = T_{low}$ to $125^\circ\text{C}$ (Note 19), unless otherwise noted)

| Characteristic  | Symbol       | MC7815AB/MC7815AC |                   |                   | Unit                       |
|---|--------------|-------------------|-------------------|-------------------|----------------------------|
|   |              | Min               | Typ               | Max               |                            |
| Output Voltage ( $T_J = 25^\circ\text{C}$ )   | $V_O$        | 14.7              | 15                | 15.3              | Vdc                        |
| Output Voltage ( $5.0\text{ mA} \leq I_O \leq 1.0\text{ A}$ , $P_D \leq 15\text{ W}$ )<br>$17.9\text{ Vdc} \leq V_{in} \leq 30\text{ Vdc}$  | $V_O$        | 14.4              | 15                | 15.6              | Vdc                        |
| Line Regulation (Note 20)<br>$17.9\text{ Vdc} \leq V_{in} \leq 30\text{ Vdc}$ , $I_O = 500\text{ mA}$<br>$20\text{ Vdc} \leq V_{in} \leq 26\text{ Vdc}$<br>$17.5\text{ Vdc} \leq V_{in} \leq 30\text{ Vdc}$ , $I_O = 1.0\text{ A}$ , $T_J = 25^\circ\text{C}$ | $Reg_{line}$ | –                 | 8.5<br>3.0<br>7.0 | 20<br>22<br>20    | mV                         |
| Load Regulation (Note 20)<br>$5.0\text{ mA} \leq I_O \leq 1.5\text{ A}$ , $T_J = 25^\circ\text{C}$<br>$5.0\text{ mA} \leq I_O \leq 1.0\text{ A}$<br>$250\text{ mA} \leq I_O \leq 750\text{ mA}$   | $Reg_{load}$ | –                 | 1.8<br>1.5<br>1.2 | 25<br>25<br>15    | mV                         |
| Quiescent Current   | $I_B$        | –                 | 3.5               | 6.0               | mA                         |
| Quiescent Current Change<br>$17.5\text{ Vdc} \leq V_{in} \leq 30\text{ Vdc}$ , $I_O = 500\text{ mA}$<br>$17.5\text{ Vdc} \leq V_{in} \leq 30\text{ Vdc}$ , $I_O = 1.0\text{ A}$ , $T_J = 25^\circ\text{C}$<br>$5.0\text{ mA} \leq I_O \leq 1.0\text{ A}$      | $\Delta I_B$ | –                 | –                 | 0.8<br>0.8<br>0.5 | mA                         |
| Ripple Rejection<br>$18.5\text{ Vdc} \leq V_{in} \leq 28.5\text{ Vdc}$ , $f = 120\text{ Hz}$ , $I_O = 500\text{ mA}$  | RR           | 60                | 80                | –                 | dB                         |
| Dropout Voltage ( $I_O = 1.0\text{ A}$ , $T_J = 25^\circ\text{C}$ )   | $V_I - V_O$  | –                 | 2.0               | –                 | Vdc                        |
| Output Noise Voltage ( $T_A = 25^\circ\text{C}$ )<br>$10\text{ Hz} \leq f \leq 100\text{ kHz}$  | $V_n$        | –                 | 10                | –                 | $\mu\text{V}/V_O$          |
| Output Resistance $f = 1.0\text{ kHz}$  | $r_O$        | –                 | 1.2               | –                 | $\text{m}\Omega$           |
| Short Circuit Current Limit ( $T_A = 25^\circ\text{C}$ )<br>$V_{in} = 35\text{ Vdc}$  | $I_{SC}$     | –                 | 0.2               | –                 | A                          |
| Peak Output Current ( $T_J = 25^\circ\text{C}$ )  | $I_{max}$    | –                 | 2.2               | –                 | A                          |
| Average Temperature Coefficient of Output Voltage   | $TCV_O$      | –                 | –1.0              | –                 | $\text{mV}/^\circ\text{C}$ |

19.  $T_{low} = 0^\circ\text{C}$  for MC78XXC, MC78XXAC,  
=  $-40^\circ\text{C}$  for NCV78XX, MC78XXB, MC78XXAB, and MC78XXAEB

20. Load and line regulation are specified at constant junction temperature. Changes in  $V_O$  due to heating effects must be taken into account separately. Pulse testing with low duty cycle is used.

## MC7800, MC7800A, MC7800AE, NCV7800

**ELECTRICAL CHARACTERISTICS** ( $V_{in} = 27\text{ V}$ ,  $I_O = 500\text{ mA}$ ,  $T_J = T_{low}$  to  $125^\circ\text{C}$  (Note 21), unless otherwise noted)

| Characteristic   | Symbol         | MC7818B   |            |            | MC7818C   |            |            | Unit                       |
|--|----------------|-----------|------------|------------|-----------|------------|------------|----------------------------|
|  |                | Min       | Typ        | Max        | Min       | Typ        | Max        |                            |
| Output Voltage ( $T_J = 25^\circ\text{C}$ )  | $V_O$          | 17.3      | 18         | 18.7       | 17.3      | 18         | 18.7       | Vdc                        |
| Output Voltage ( $5.0\text{ mA} \leq I_O \leq 1.0\text{ A}$ , $P_D \leq 15\text{ W}$ )<br>$21\text{ Vdc} \leq V_{in} \leq 33\text{ Vdc}$<br>$22\text{ Vdc} \leq V_{in} \leq 33\text{ Vdc}$ | $V_O$          | –<br>17.1 | –<br>18    | –<br>18.9  | 17.1<br>– | 18<br>–    | 18.9<br>–  | Vdc                        |
| Line Regulation, (Note 22)<br>$21\text{ Vdc} \leq V_{in} \leq 33\text{ Vdc}$<br>$24\text{ Vdc} \leq V_{in} \leq 33\text{ Vdc}$   | $Reg_{line}$   | –<br>–    | 9.5<br>3.2 | 360<br>180 | –<br>–    | 9.5<br>3.2 | 50<br>25   | mV                         |
| Load Regulation, (Note 22)<br>$5.0\text{ mA} \leq I_O \leq 1.5\text{ A}$   | $Reg_{load}$   | –         | 2.0        | 360        | –         | 2.0        | 55         | mV                         |
| Quiescent Current  | $I_B$          | –         | 3.5        | 8.0        | –         | 3.5        | 6.5        | mA                         |
| Quiescent Current Change<br>$21\text{ Vdc} \leq V_{in} \leq 33\text{ Vdc}$<br>$5.0\text{ mA} \leq I_O \leq 1.0\text{ A}$   | $\Delta I_B$   | –<br>–    | –<br>–     | –<br>0.5   | –<br>–    | –<br>–     | 1.0<br>0.5 | mA                         |
| Ripple Rejection<br>$22\text{ Vdc} \leq V_{in} \leq 33\text{ Vdc}$ , $f = 120\text{ Hz}$   | RR             | –         | 57         | –          | 53        | 57         | –          | dB                         |
| Dropout Voltage ( $I_O = 1.0\text{ A}$ , $T_J = 25^\circ\text{C}$ )  | $V_{il} - V_O$ | –         | 2.0        | –          | –         | 2.0        | –          | Vdc                        |
| Output Noise Voltage ( $T_A = 25^\circ\text{C}$ )<br>$10\text{ Hz} \leq f \leq 100\text{ kHz}$   | $V_n$          | –         | 10         | –          | –         | 10         | –          | $\mu\text{V}/V_O$          |
| Output Resistance $f = 1.0\text{ kHz}$   | $r_O$          | –         | 1.3        | –          | –         | 1.3        | –          | $\text{m}\Omega$           |
| Short Circuit Current Limit ( $T_A = 25^\circ\text{C}$ )<br>$V_{in} = 35\text{ Vdc}$   | $I_{SC}$       | –         | 0.2        | –          | –         | 0.2        | –          | A                          |
| Peak Output Current ( $T_J = 25^\circ\text{C}$ )   | $I_{max}$      | –         | 2.2        | –          | –         | 2.2        | –          | A                          |
| Average Temperature Coefficient of Output Voltage  | $TCV_O$        | –         | –1.5       | –          | –         | –1.5       | –          | $\text{mV}/^\circ\text{C}$ |

21.  $T_{low} = 0^\circ\text{C}$  for MC78XXC, MC78XXAC,  
=  $-40^\circ\text{C}$  for NCV78XX, MC78XXB, MC78XXAB, and MC78XXAEB

22. Load and line regulation are specified at constant junction temperature. Changes in  $V_O$  due to heating effects must be taken into account separately. Pulse testing with low duty cycle is used.

# MC7800, MC7800A, MC7800AE, NCV7800

## ELECTRICAL CHARACTERISTICS ( $V_{in} = 27\text{ V}$ , $I_O = 1.0\text{ A}$ , $T_J = T_{low}$ to $125^\circ\text{C}$ (Note 23), unless otherwise noted)

| Characteristic   | Symbol       | MC7818AC |                          |                        | Unit                       |
|--|--------------|----------|--------------------------|------------------------|----------------------------|
|  |              | Min      | Typ                      | Max                    |                            |
| Output Voltage ( $T_J = 25^\circ\text{C}$ )  | $V_O$        | 17.64    | 18                       | 18.36                  | Vdc                        |
| Output Voltage ( $5.0\text{ mA} \leq I_O \leq 1.0\text{ A}$ , $P_D \leq 15\text{ W}$ )<br>$21\text{ Vdc} \leq V_{in} \leq 33\text{ Vdc}$   | $V_O$        | 17.3     | 18                       | 18.7                   | Vdc                        |
| Line Regulation (Note 24)<br>$21\text{ Vdc} \leq V_{in} \leq 33\text{ Vdc}$ , $I_O = 500\text{ mA}$<br>$24\text{ Vdc} \leq V_{in} \leq 30\text{ Vdc}$ , $I_O = 1.0\text{ A}$<br>$24\text{ Vdc} \leq V_{in} \leq 30\text{ Vdc}$ , $I_O = 1.0\text{ A}$ , $T_J = 25^\circ\text{C}$<br>$20.6\text{ Vdc} \leq V_{in} \leq 33\text{ Vdc}$ , $I_O = 1.0\text{ A}$ , $T_J = 25^\circ\text{C}$ | $Reg_{line}$ | -        | 9.5<br>3.2<br>3.2<br>8.0 | 22<br>25<br>10.5<br>22 | mV                         |
| Load Regulation (Note 24)<br>$5.0\text{ mA} \leq I_O \leq 1.5\text{ A}$ , $T_J = 25^\circ\text{C}$<br>$5.0\text{ mA} \leq I_O \leq 1.0\text{ A}$<br>$250\text{ mA} \leq I_O \leq 750\text{ mA}$  | $Reg_{load}$ | -        | 2.0<br>1.8<br>1.5        | 25<br>25<br>15         | mV                         |
| Quiescent Current  | $I_B$        | -        | 3.5                      | 6.0                    | mA                         |
| Quiescent Current Change<br>$21\text{ Vdc} \leq V_{in} \leq 33\text{ Vdc}$ , $I_O = 500\text{ mA}$<br>$21.5\text{ Vdc} \leq V_{in} \leq 30\text{ Vdc}$ , $T_J = 25^\circ\text{C}$<br>$5.0\text{ mA} \leq I_O \leq 1.0\text{ A}$  | $\Delta I_B$ | -        | -                        | 0.8<br>0.8<br>0.5      | mA                         |
| Ripple Rejection<br>$22\text{ Vdc} \leq V_{in} \leq 32\text{ Vdc}$ , $f = 120\text{ Hz}$ , $I_O = 500\text{ mA}$   | RR           | 53       | 57                       | -                      | dB                         |
| Dropout Voltage ( $I_O = 1.0\text{ A}$ , $T_J = 25^\circ\text{C}$ )  | $V_I - V_O$  | -        | 2.0                      | -                      | Vdc                        |
| Output Noise Voltage ( $T_A = 25^\circ\text{C}$ )<br>$10\text{ Hz} \leq f \leq 100\text{ kHz}$   | $V_n$        | -        | 10                       | -                      | $\mu\text{V}/V_O$          |
| Output Resistance $f = 1.0\text{ kHz}$   | $r_O$        | -        | 1.3                      | -                      | $\text{m}\Omega$           |
| Short Circuit Current Limit ( $T_A = 25^\circ\text{C}$ )<br>$V_{in} = 35\text{ Vdc}$   | $I_{sc}$     | -        | 0.2                      | -                      | A                          |
| Peak Output Current ( $T_J = 25^\circ\text{C}$ )   | $I_{max}$    | -        | 2.2                      | -                      | A                          |
| Average Temperature Coefficient of Output Voltage  | $TCV_O$      | -        | -1.5                     | -                      | $\text{mV}/^\circ\text{C}$ |

23.  $T_{low} = 0^\circ\text{C}$  for MC78XXC, MC78XXAC,  
 $= -40^\circ\text{C}$  for NCV78XX, MC78XXB, MC78XXAB, and MC78XXAEB

24. Load and line regulation are specified at constant junction temperature. Changes in  $V_O$  due to heating effects must be taken into account separately. Pulse testing with low duty cycle is used.

## MC7800, MC7800A, MC7800AE, NCV7800

**ELECTRICAL CHARACTERISTICS** ( $V_{in} = 33\text{ V}$ ,  $I_O = 500\text{ mA}$ ,  $T_J = T_{low}$  to  $125^\circ\text{C}$  (Note 25), unless otherwise noted)

| Characteristic   | Symbol       | MC7824B   |             |            | MC7824C   |            |            | Unit                       |
|--|--------------|-----------|-------------|------------|-----------|------------|------------|----------------------------|
|  |              | Min       | Typ         | Max        | Min       | Typ        | Max        |                            |
| Output Voltage ( $T_J = 25^\circ\text{C}$ )  | $V_O$        | 23        | 24          | 25         | 23        | 24         | 25         | Vdc                        |
| Output Voltage ( $5.0\text{ mA} \leq I_O \leq 1.0\text{ A}$ , $P_D \leq 15\text{ W}$ )<br>$27\text{ Vdc} \leq V_{in} \leq 38\text{ Vdc}$<br>$28\text{ Vdc} \leq V_{in} \leq 38\text{ Vdc}$ | $V_O$        | –<br>22.8 | –<br>24     | –<br>25.2  | 22.8<br>– | 24<br>–    | 25.2<br>–  | Vdc                        |
| Line Regulation, (Note 26)<br>$27\text{ Vdc} \leq V_{in} \leq 38\text{ Vdc}$<br>$30\text{ Vdc} \leq V_{in} \leq 38\text{ Vdc}$   | $Reg_{line}$ | –<br>–    | 11.5<br>3.8 | 480<br>240 | –<br>–    | 2.7<br>2.7 | 60<br>48   | mV                         |
| Load Regulation, (Note 26)<br>$5.0\text{ mA} \leq I_O \leq 1.5\text{ A}$   | $Reg_{load}$ | –         | 2.1         | 480        | –         | 4.4        | 65         | mV                         |
| Quiescent Current  | $I_B$        | –         | 3.6         | 8.0        | –         | 3.6        | 6.5        | mA                         |
| Quiescent Current Change<br>$27\text{ Vdc} \leq V_{in} \leq 38\text{ Vdc}$<br>$5.0\text{ mA} \leq I_O \leq 1.0\text{ A}$   | $\Delta I_B$ | –<br>–    | –<br>–      | –<br>0.5   | –<br>–    | –<br>–     | 1.0<br>0.5 | mA                         |
| Ripple Rejection<br>$28\text{ Vdc} \leq V_{in} \leq 38\text{ Vdc}$ , $f = 120\text{ Hz}$   | RR           | –         | 54          | –          | 50        | 54         | –          | dB                         |
| Dropout Voltage ( $I_O = 1.0\text{ A}$ , $T_J = 25^\circ\text{C}$ )  | $V_I - V_O$  | –         | 2.0         | –          | –         | 2.0        | –          | Vdc                        |
| Output Noise Voltage ( $T_A = 25^\circ\text{C}$ )<br>$10\text{ Hz} \leq f \leq 100\text{ kHz}$   | $V_n$        | –         | 10          | –          | –         | 10         | –          | $\mu\text{V}/V_O$          |
| Output Resistance $f = 1.0\text{ kHz}$   | $r_O$        | –         | 1.4         | –          | –         | 1.4        | –          | $\text{m}\Omega$           |
| Short Circuit Current Limit ( $T_A = 25^\circ\text{C}$ )<br>$V_{in} = 35\text{ Vdc}$   | $I_{SC}$     | –         | 0.2         | –          | –         | 0.2        | –          | A                          |
| Peak Output Current ( $T_J = 25^\circ\text{C}$ )   | $I_{max}$    | –         | 2.2         | –          | –         | 2.2        | –          | A                          |
| Average Temperature Coefficient of Output Voltage  | $TCV_O$      | –         | –2.0        | –          | –         | –2.0       | –          | $\text{mV}/^\circ\text{C}$ |

25.  $T_{low} = 0^\circ\text{C}$  for MC78XXC, MC78XXAC,  
=  $-40^\circ\text{C}$  for NCV78XX, MC78XXB, MC78XXAB, and MC78XXAEB

26. Load and line regulation are specified at constant junction temperature. Changes in  $V_O$  due to heating effects must be taken into account separately. Pulse testing with low duty cycle is used.

## MC7800, MC7800A, MC7800AE, NCV7800

### ELECTRICAL CHARACTERISTICS ( $V_{in} = 33\text{ V}$ , $I_O = 1.0\text{ A}$ , $T_J = T_{low}$ to $125^\circ\text{C}$ (Note 27), unless otherwise noted)

| Characteristic  | Symbol       | MC7824AC |                          |                      | Unit                       |
|---|--------------|----------|--------------------------|----------------------|----------------------------|
|   |              | Min      | Typ                      | Max                  |                            |
| Output Voltage ( $T_J = 25^\circ\text{C}$ )   | $V_O$        | 23.5     | 24                       | 24.5                 | Vdc                        |
| Output Voltage ( $5.0\text{ mA} \leq I_O \leq 1.0\text{ A}$ , $P_D \leq 15\text{ W}$ )<br>$27.3\text{ Vdc} \leq V_{in} \leq 38\text{ Vdc}$  | $V_O$        | 23.2     | 24                       | 25.8                 | Vdc                        |
| Line Regulation (Note 28)<br>$27\text{ Vdc} \leq V_{in} \leq 38\text{ Vdc}$ , $I_O = 500\text{ mA}$<br>$30\text{ Vdc} \leq V_{in} \leq 36\text{ Vdc}$ , $I_O = 1.0\text{ A}$<br>$30\text{ Vdc} \leq V_{in} \leq 36\text{ Vdc}$ , $T_J = 25^\circ\text{C}$<br>$26.7\text{ Vdc} \leq V_{in} \leq 38\text{ Vdc}$ , $I_O = 1.0\text{ A}$ , $T_J = 25^\circ\text{C}$ | $Reg_{line}$ | -        | 11.5<br>3.8<br>3.8<br>10 | 25<br>28<br>12<br>25 | mV                         |
| Load Regulation (Note 28)<br>$5.0\text{ mA} \leq I_O \leq 1.5\text{ A}$ , $T_J = 25^\circ\text{C}$<br>$5.0\text{ mA} \leq I_O \leq 1.0\text{ A}$<br>$250\text{ mA} \leq I_O \leq 750\text{ mA}$   | $Reg_{load}$ | -        | 2.1<br>2.0<br>1.8        | 15<br>25<br>15       | mV                         |
| Quiescent Current   | $I_B$        | -        | 3.6                      | 6.0                  | mA                         |
| Quiescent Current Change<br>$27.3\text{ Vdc} \leq V_{in} \leq 38\text{ Vdc}$ , $I_O = 500\text{ mA}$<br>$27\text{ Vdc} \leq V_{in} \leq 38\text{ Vdc}$ , $T_J = 25^\circ\text{C}$<br>$5.0\text{ mA} \leq I_O \leq 1.0\text{ A}$   | $\Delta I_B$ | -        | -                        | 0.8<br>0.8<br>0.5    | mA                         |
| Ripple Rejection<br>$28\text{ Vdc} \leq V_{in} \leq 38\text{ Vdc}$ , $f = 120\text{ Hz}$ , $I_O = 500\text{ mA}$  | RR           | 45       | 54                       | -                    | dB                         |
| Dropout Voltage ( $I_O = 1.0\text{ A}$ , $T_J = 25^\circ\text{C}$ )   | $V_I - V_O$  | -        | 2.0                      | -                    | Vdc                        |
| Output Noise Voltage ( $T_A = 25^\circ\text{C}$ )<br>$10\text{ Hz} \leq f \leq 100\text{ kHz}$  | $V_n$        | -        | 10                       | -                    | $\mu\text{V}/V_O$          |
| Output Resistance ( $f = 1.0\text{ kHz}$ )  | $r_O$        | -        | 1.4                      | -                    | $\text{m}\Omega$           |
| Short Circuit Current Limit ( $T_A = 25^\circ\text{C}$ )<br>$V_{in} = 35\text{ Vdc}$  | $I_{sc}$     | -        | 0.2                      | -                    | A                          |
| Peak Output Current ( $T_J = 25^\circ\text{C}$ )  | $I_{max}$    | -        | 2.2                      | -                    | A                          |
| Average Temperature Coefficient of Output Voltage   | $TCV_O$      | -        | -2.0                     | -                    | $\text{mV}/^\circ\text{C}$ |

27.  $T_{low} = 0^\circ\text{C}$  for MC78XXC, MC78XXAC,  
 $= -40^\circ\text{C}$  for NCV78XX, MC78XXB, MC78XXAB, and MC78XXAEB

28. Load and line regulation are specified at constant junction temperature. Changes in  $V_O$  due to heating effects must be taken into account separately. Pulse testing with low duty cycle is used.

# MC7800, MC7800A, MC7800AE, NCV7800

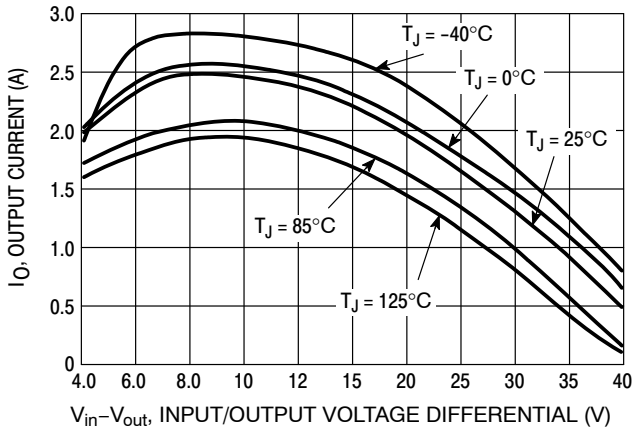

**Figure 2. Peak Output Current as a Function of Input/Output Differential Voltage (MC78XXC, AC, B)**

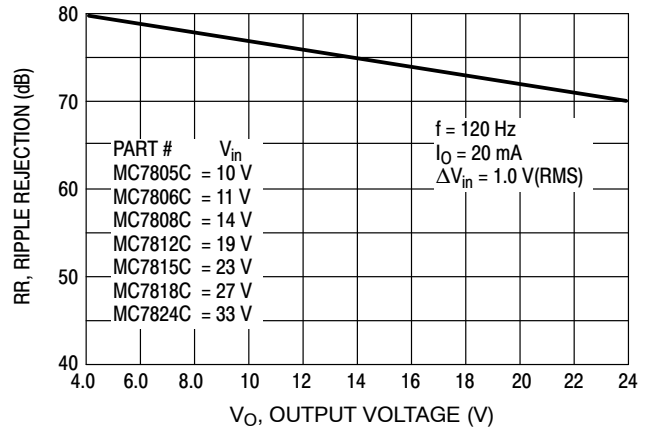

**Figure 3. Ripple Rejection as a Function of Output Voltages (MC78XXC, AC, B)**

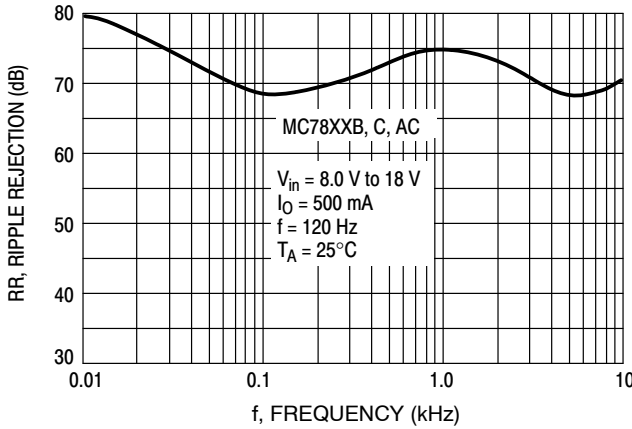

**Figure 4. Ripple Rejection as a Function of Frequency (MC78XXC, AC, B)**

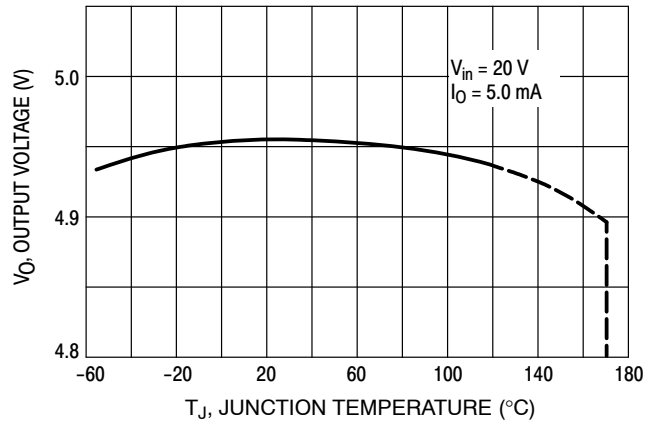

**Figure 5. Output Voltage as a Function of Junction Temperature (MC7805C, AC, B)**

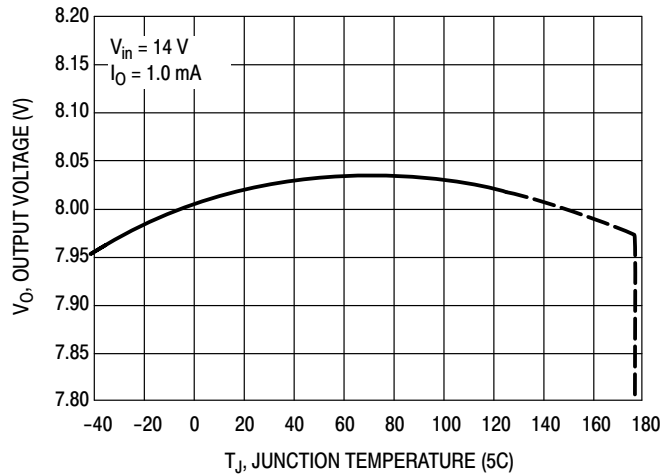

**Figure 6. Output Voltage as a Function of Junction Temperature (MC7808AE)**



# MC7800, MC7800A, MC7800AE, NCV7800

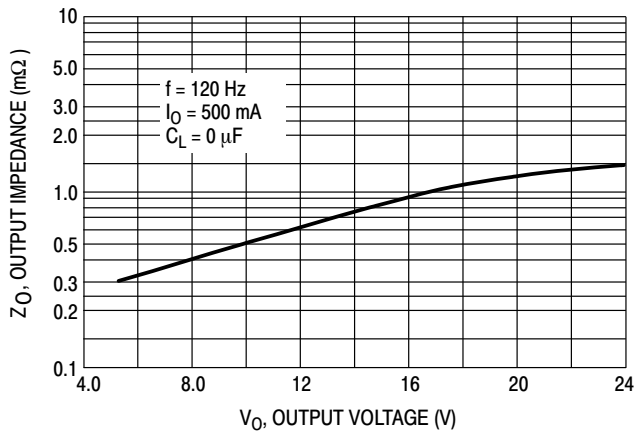

Figure 7. Output Impedance as a Function of Output Voltage (MC78XXC, AC, B)

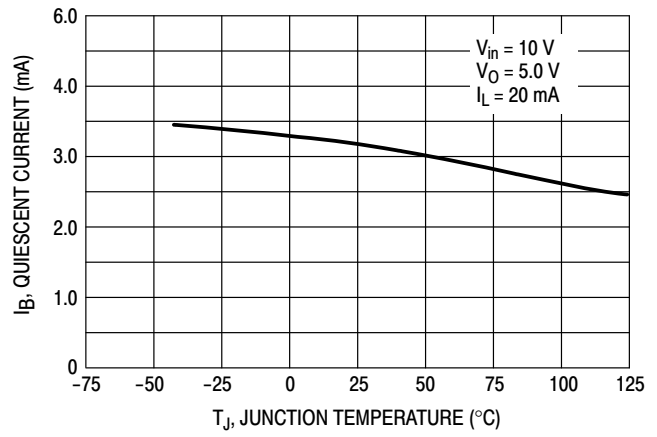

Figure 8. Quiescent Current as a Function of Temperature (MC78XXC, AC, B)

APPLICATIONS INFORMATION

Design Considerations

The MC7800 Series of fixed voltage regulators are designed with Thermal Overload Protection that shuts down the circuit when subjected to an excessive power overload condition, Internal Short Circuit Protection that limits the maximum current the circuit will pass, and Output Transistor Safe-Area Compensation that reduces the output short circuit current as the voltage across the pass transistor is increased.

In many low current applications, compensation capacitors are not required. However, it is recommended that the regulator input be bypassed with a capacitor if the regulator is connected to the power supply filter with long

wire lengths, or if the output load capacitance is large. An input bypass capacitor should be selected to provide good high-frequency characteristics to insure stable operation under all load conditions. A 0.33 μF or larger tantalum, mylar, or other capacitor having low internal impedance at high frequencies should be chosen. The bypass capacitor should be mounted with the shortest possible leads directly across the regulators input terminals. Normally good construction techniques should be used to minimize ground loops and lead resistance drops since the regulator has no external sense lead.

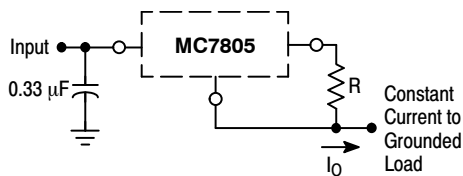

The MC7800 regulators can also be used as a current source when connected as above. In order to minimize dissipation the MC7805C is chosen in this application. Resistor R determines the current as follows:

$$I_O = \frac{5.0 \text{ V}}{R} + I_B$$

$I_B \cong 3.2 \text{ mA}$  over line and load changes.

For example, a 1.0 A current source would require R to be a 5.0 Ω, 10 W resistor and the output voltage compliance would be the input voltage less 7.0 V.

Figure 9. Current Regulator

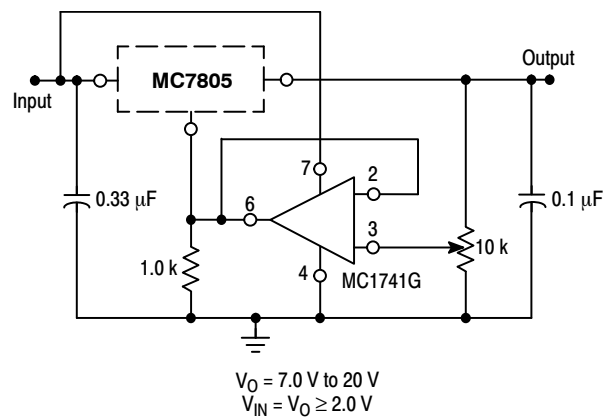

The addition of an operational amplifier allows adjustment to higher or intermediate values while retaining regulation characteristics. The minimum voltage obtainable with this arrangement is 2.0 V greater than the regulator voltage.

Figure 10. Adjustable Output Regulator

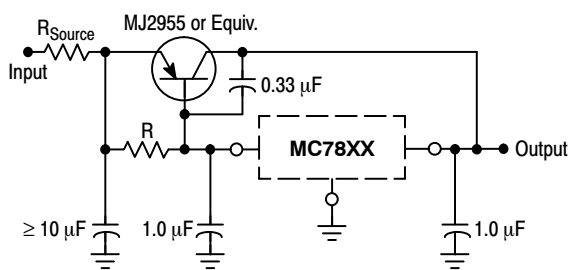

XX = 2 digits of type number indicating voltage.

The MC7800 series can be current boosted with a PNP transistor. The MJ2955 provides current to 5.0 A. Resistor R in conjunction with the  $V_{BE}$  of the PNP determines when the pass transistor begins conducting; this circuit is not short circuit proof. Input/output differential voltage minimum is increased by  $V_{BE}$  of the pass transistor.

Figure 11. Current Boost Regulator

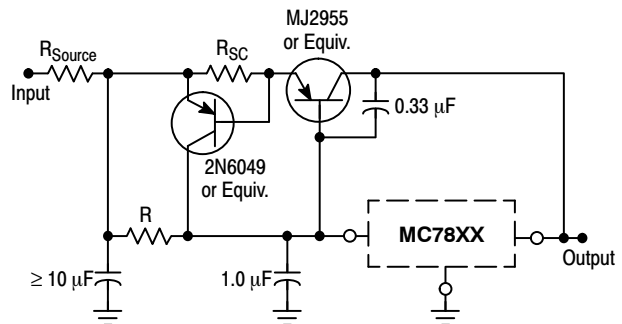

XX = 2 digits of type number indicating voltage.

The circuit of Figure 11 can be modified to provide supply protection against short circuits by adding a short circuit sense resistor,  $R_{SC}$ , and an additional PNP transistor. The current sensing PNP must be able to handle the short circuit current of the three-terminal regulator. Therefore, a four-ampere plastic power transistor is specified.

Figure 12. Short Circuit Protection

# MC7800, MC7800A, MC7800AE, NCV7800

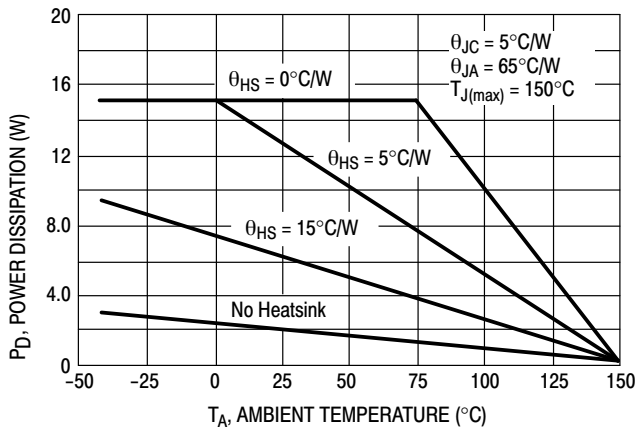

Figure 13. Worst Case Power Dissipation versus Ambient Temperature (Case 221A)

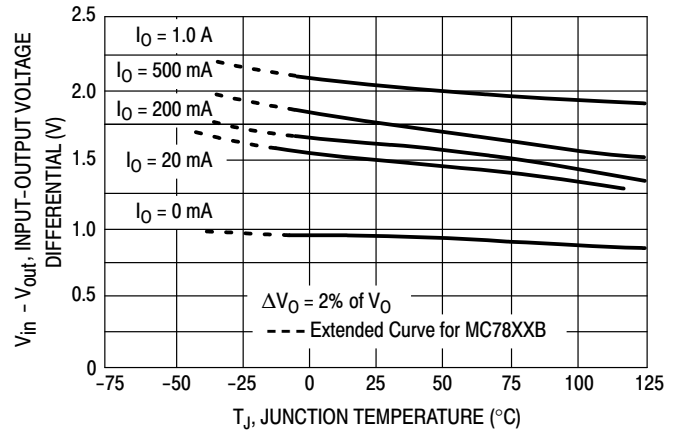

Figure 14. Input Output Differential as a Function of Junction Temperature (MC78XXC, AC, B)

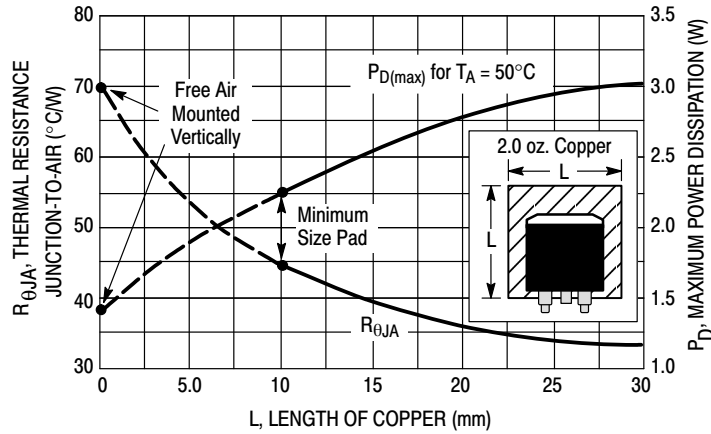

Figure 15. D<sup>2</sup>PAK Thermal Resistance and Maximum Power Dissipation versus P.C.B. Copper Length

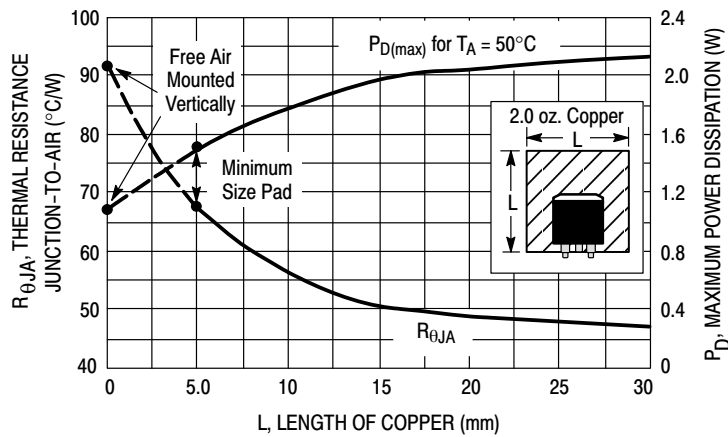

Figure 16. DPAK Thermal Resistance and Maximum Power Dissipation versus P.C.B. Copper Length

# MC7800, MC7800A, MC7800AE, NCV7800

## DEFINITIONS

**Line Regulation** – The change in output voltage for a change in the input voltage. The measurement is made under conditions of low dissipation or by using pulse techniques such that the average chip temperature is not significantly affected.

**Load Regulation** – The change in output voltage for a change in load current at constant chip temperature.

**Maximum Power Dissipation** – The maximum total device dissipation for which the regulator will operate within specifications.

**Quiescent Current** – That part of the input current that is not delivered to the load.

**Output Noise Voltage** – The rms ac voltage at the output, with constant load and no input ripple, measured over a specified frequency range.

**Long Term Stability** – Output voltage stability under accelerated life test conditions with the maximum rated voltage listed in the devices' electrical characteristics and maximum power dissipation.

## ORDERING INFORMATION

| Device           | Nominal Voltage | Operating Temperature Range      | Package                      | Shipping <sup>†</sup> |
|------------------|-----------------|----------------------------------|------------------------------|-----------------------|
| MC7805ABD2TR4G   | 5.0 V           | T <sub>J</sub> = -40°C to +125°C | D <sup>2</sup> PAK (Pb-free) | 800 / Tape & Reel     |
| NCV7805ABD2TR4G* | 5.0 V           | T <sub>J</sub> = -40°C to +125°C | D <sup>2</sup> PAK (Pb-free) | 800 / Tape & Reel     |
| MC7805ABTG       | 5.0 V           | T <sub>J</sub> = -40°C to +125°C | TO-220 (Pb-free)             | 50 Units /Rail        |
| MC7805ACD2TG     | 5.0 V           | T <sub>J</sub> = 0°C to +125°C   | D <sup>2</sup> PAK (Pb-free) | 50 Units /Rail        |
| MC7805ACD2TR4G   | 5.0 V           | T <sub>J</sub> = 0°C to +125°C   | D <sup>2</sup> PAK (Pb-free) | 800 / Tape & Reel     |
| MC7805ACTG       | 5.0 V           | T <sub>J</sub> = 0°C to +125°C   | TO-220 (Pb-free)             | 50 Units /Rail        |
| MC7805BD2TG      | 5.0 V           | T <sub>J</sub> = -40°C to +125°C | D <sup>2</sup> PAK (Pb-free) | 50 Units /Rail        |
| MC7805BD2TR4G    | 5.0 V           | T <sub>J</sub> = -40°C to +125°C | D <sup>2</sup> PAK (Pb-free) | 800 / Tape & Reel     |
| MC7805BDTG       | 5.0 V           | T <sub>J</sub> = -40°C to +125°C | DPAK (Pb-free)               | 75 Units / Rail       |
| MC7805BDTRKG     | 5.0 V           | T <sub>J</sub> = -40°C to +125°C | DPAK (Pb-free)               | 2500 / Tape & Reel    |
| NCV7805BDTRKG*   | 5.0 V           | T <sub>J</sub> = -40°C to +125°C | DPAK (Pb-free)               | 2500 / Tape & Reel    |
| MC7805BTG        | 5.0 V           | T <sub>J</sub> = -40°C to +125°C | TO-220 (Pb-free)             | 50 Units /Rail        |
| NCV7805BTG*      | 5.0 V           | T <sub>J</sub> = -40°C to +125°C | TO-220 (Pb-free)             | 50 Units /Rail        |
| NCV7805BD2TG*    | 5.0 V           | T <sub>J</sub> = -40°C to +125°C | D <sup>2</sup> PAK (Pb-free) | 50 Units /Rail        |
| NCV7805BD2TR4G*  | 5.0 V           | T <sub>J</sub> = -40°C to +125°C | D <sup>2</sup> PAK (Pb-free) | 800 / Tape & Reel     |
| MC7805CD2TG      | 5.0 V           | T <sub>J</sub> = 0°C to +125°C   | D <sup>2</sup> PAK (Pb-free) | 50 Units /Rail        |
| MC7805CD2TR4G    | 5.0 V           | T <sub>J</sub> = 0°C to +125°C   | D <sup>2</sup> PAK (Pb-free) | 800 / Tape & Reel     |
| MC7805CDTG       | 5.0 V           | T <sub>J</sub> = 0°C to +125°C   | DPAK (Pb-free)               | 75 Units / Rail       |

<sup>†</sup>For information on tape and reel specifications, including part orientation and tape sizes, please refer to our Tape and Reel Packaging Specifications Brochure, BRD8011/D.

\*NCV devices: T<sub>low</sub> = -40°C, T<sub>high</sub> = +125°C. Guaranteed by design. NCV Prefix for Automotive and Other Applications Requiring Unique Site and Control Change Requirements; AEC-Q100 Qualified and PPAP Capable.

## MC7800, MC7800A, MC7800AE, NCV7800

### ORDERING INFORMATION (continued)

| Device           | Nominal Voltage | Operating Temperature Range      | Package                         | Shipping <sup>†</sup> |
|------------------|-----------------|----------------------------------|---------------------------------|-----------------------|
| MC7805CDTRKG     | 5.0 V           | T <sub>J</sub> = 0°C to +125°C   | DPAK<br>(Pb-free)               | 2500 / Tape & Reel    |
| MC7805CTG        | 5.0 V           | T <sub>J</sub> = 0°C to +125°C   | TO-220<br>(Pb-free)             | 50 Units / Rail       |
| NCV7808ABD2TR4G* | 8.0 V           | T <sub>J</sub> = -40°C to +125°C | D <sup>2</sup> PAK<br>(Pb-free) | 800 / Tape & Reel     |
| MC7808AEBTG      | 8.0 V           | T <sub>J</sub> = -40°C to +125°C | TO-220<br>(Pb-free)             | 50 Units / Rail       |
| NCV7808BD2TR4G*  | 8.0 V           | T <sub>J</sub> = -40°C to +125°C | D <sup>2</sup> PAK<br>(Pb-free) | 800 / Tape & Reel     |
| NCV7808BDTG*     | 8.0 V           | T <sub>J</sub> = -40°C to +125°C | DPAK<br>(Pb-free)               | 75 Units / Rail       |
| NCV7808BDTRKG*   | 8.0 V           | T <sub>J</sub> = -40°C to +125°C | DPAK<br>(Pb-free)               | 2500 / Tape & Reel    |
| NCV7808BTG*      | 8.0 V           | T <sub>J</sub> = -40°C to +125°C | TO-220<br>(Pb-free)             | 50 Units / Rail       |
| MC7808CDTRKG     | 8.0 V           | T <sub>J</sub> = 0°C to +125°C   | DPAK<br>(Pb-free)               | 2500 / Tape & Reel    |
| MC7808CTG        | 8.0 V           | T <sub>J</sub> = 0°C to +125°C   | TO-220<br>(Pb-free)             | 50 Units / Rail       |
| MC7809ABTG       | 9.0 V           | T <sub>J</sub> = -40°C to +125°C | TO-220<br>(Pb-free)             | 50 Units / Rail       |
| NCV7809BD2TR4G*  | 9.0 V           | T <sub>J</sub> = -40°C to +125°C | D <sup>2</sup> PAK<br>(Pb-free) | 800 / Tape & Reel     |
| NCV7809BTG*      | 9.0 V           | T <sub>J</sub> = -40°C to +125°C | TO-220<br>(Pb-free)             | 50 Units / Rail       |
| MC7809CTG        | 9.0 V           | T <sub>J</sub> = 0°C to +125°C   | TO-220<br>(Pb-free)             | 50 Units / Rail       |
| MC7812ABD2TR4G   | 12 V            | T <sub>J</sub> = -40°C to +125°C | D <sup>2</sup> PAK<br>(Pb-free) | 800 / Tape & Reel     |
| NCV7812ABTG*     | 12 V            | T <sub>J</sub> = -40°C to +125°C | TO-220<br>(Pb-free)             | 50 Units / Rail       |
| MC7812ACD2TR4G   | 12 V            | T <sub>J</sub> = 0°C to +125°C   | D <sup>2</sup> PAK<br>(Pb-free) | 800 / Tape & Reel     |
| MC7812ACTG       | 12 V            | T <sub>J</sub> = 0°C to +125°C   | TO-220<br>(Pb-free)             | 50 Units / Rail       |
| MC7812BD2TR4G    | 12 V            | T <sub>J</sub> = -40°C to +125°C | D <sup>2</sup> PAK<br>(Pb-free) | 800 / Tape & Reel     |
| NCV7812BD2TR4G*  | 12 V            | T <sub>J</sub> = -40°C to +125°C | D <sup>2</sup> PAK<br>(Pb-free) | 800 / Tape & Reel     |
| MC7812BDTG       | 12 V            | T <sub>J</sub> = -40°C to +125°C | DPAK<br>(Pb-free)               | 75 Units / Rail       |
| MC7812BDTRKG     | 12 V            | T <sub>J</sub> = -40°C to +125°C | DPAK<br>(Pb-free)               | 2500 / Tape & Reel    |
| MC7812BTG        | 12 V            | T <sub>J</sub> = -40°C to +125°C | TO-220<br>(Pb-free)             | 50 Units / Rail       |
| NCV7812BTG*      | 12 V            | T <sub>J</sub> = -40°C to +125°C | TO-220<br>(Pb-free)             | 50 Units / Rail       |

<sup>†</sup>For information on tape and reel specifications, including part orientation and tape sizes, please refer to our Tape and Reel Packaging Specifications Brochure, BRD8011/D.

\*NCV devices: T<sub>low</sub> = -40°C, T<sub>high</sub> = +125°C. Guaranteed by design. NCV Prefix for Automotive and Other Applications Requiring Unique Site and Control Change Requirements; AEC-Q100 Qualified and PPAP Capable.

## MC7800, MC7800A, MC7800AE, NCV7800

### ORDERING INFORMATION (continued)

| Device         | Nominal Voltage | Operating Temperature Range      | Package                      | Shipping <sup>†</sup> |
|----------------|-----------------|----------------------------------|------------------------------|-----------------------|
| MC7812CD2TR4G  | 12 V            | T <sub>J</sub> = 0°C to +125°C   | D <sup>2</sup> PAK (Pb-free) | 800 / Tape & Reel     |
| MC7812CDTRKG   | 12 V            | T <sub>J</sub> = 0°C to +125°C   | DPAK (Pb-free)               | 2500 / Tape & Reel    |
| MC7812CTG      | 12 V            | T <sub>J</sub> = 0°C to +125°C   | TO-220 (Pb-free)             | 50 Units / Rail       |
| MC7815ABD2TR4G | 15 V            | T <sub>J</sub> = -40°C to +125°C | D <sup>2</sup> PAK (Pb-free) | 800 / Tape & Reel     |
| MC7815ABTG     | 15 V            | T <sub>J</sub> = -40°C to +125°C | TO-220 (Pb-free)             | 50 Units /Rail        |
| MC7815ACTG     | 15 V            | T <sub>J</sub> = 0°C to +125°C   | TO-220 (Pb-free)             | 50 Units / Rail       |
| MC7815BD2TR4G  | 15 V            | T <sub>J</sub> = -40°C to +125°C | D <sup>2</sup> PAK (Pb-free) | 800 / Tape & Reel     |
| MC7815BDTRKG   | 15 V            | T <sub>J</sub> = -40°C to +125°C | DPAK (Pb-free)               | 2500 / Tape & Reel    |
| MC7815BTG      | 15 V            | T <sub>J</sub> = -40°C to +125°C | TO-220 (Pb-free)             | 50 Units / Rail       |
| NCV7815BTG*    | 15 V            | T <sub>J</sub> = -40°C to +125°C | TO-220 (Pb-free)             | 50 Units / Rail       |
| MC7815CD2TG    | 15 V            | T <sub>J</sub> = 0°C to +125°C   | D <sup>2</sup> PAK (Pb-free) | 50 Units /Rail        |
| MC7815CD2TR4G  | 15 V            | T <sub>J</sub> = 0°C to +125°C   | D <sup>2</sup> PAK (Pb-free) | 800 / Tape & Reel     |
| MC7815CDTRKG   | 15 V            | T <sub>J</sub> = 0°C to +125°C   | DPAK (Pb-free)               | 2500 / Tape & Reel    |
| MC7815CTG      | 15 V            | T <sub>J</sub> = 0°C to +125°C   | TO-220 (Pb-free)             | 50 Units /Rail        |
| MC7818BTG      | 18 V            | T <sub>J</sub> = -40°C to +125°C | TO-220 (Pb-free)             | 50 Units /Rail        |
| MC7818CD2TR4G  | 18 V            | T <sub>J</sub> = 0°C to +125°C   | D <sup>2</sup> PAK (Pb-free) | 800 / Tape & Reel     |
| MC7818CTG      | 18 V            | T <sub>J</sub> = 0°C to +125°C   | TO-220 (Pb-free)             | 50 Units /Rail        |
| MC7824ACTG     | 24 V            | T <sub>J</sub> = 0°C to +125°C   | TO-220 (Pb-free)             | 50 Units /Rail        |
| MC7824BTG      | 24 V            | T <sub>J</sub> = -40°C to +125°C | TO-220 (Pb-free)             | 50 Units /Rail        |
| MC7824CD2TR4G  | 24 V            | T <sub>J</sub> = 0°C to +125°C   | D <sup>2</sup> PAK (Pb-free) | 800 / Tape & Reel     |
| MC7824CTG      | 24 V            | T <sub>J</sub> = 0°C to +125°C   | TO-220 (Pb-free)             | 50 Units /Rail        |

<sup>†</sup>For information on tape and reel specifications, including part orientation and tape sizes, please refer to our Tape and Reel Packaging Specifications Brochure, BRD8011/D.

\*NCV devices: T<sub>low</sub> = -40°C, T<sub>high</sub> = +125°C. Guaranteed by design. NCV Prefix for Automotive and Other Applications Requiring Unique Site and Control Change Requirements; AEC-Q100 Qualified and PPAP Capable.

# MC7800, MC7800A, MC7800AE, NCV7800

## MARKING DIAGRAMS

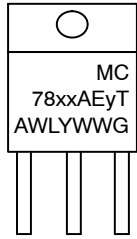

**TO-220-3  
T SUFFIX  
CASE 221A**

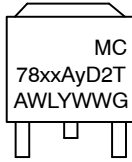
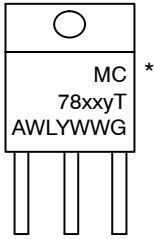
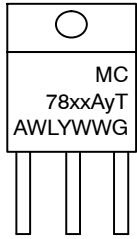

**D<sup>2</sup>PAK-3  
D2T SUFFIX  
CASE 936**

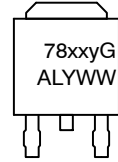
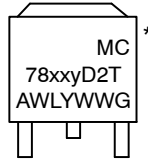

**DPAK-3  
DT SUFFIX  
CASE 369C**

\*This marking diagram also applies to NCV78xx family.

xx = 05, 06, 08, 09, 12, 15, 18, or 24  
y = B or C  
A = Assembly Location  
WL, L = Wafer Lot  
Y = Year  
WW = Work Week  
G = Pb-Free Device

# MECHANICAL CASE OUTLINE

## PACKAGE DIMENSIONS

ON Semiconductor®



### TO-220, SINGLE GAUGE CASE 221AB-01 ISSUE A

DATE 16 NOV 2010

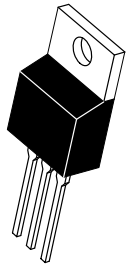

SCALE 1:1

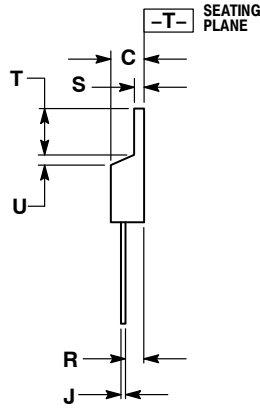
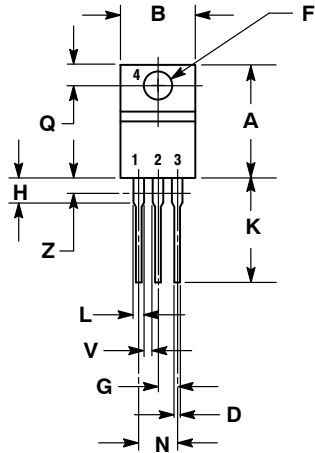

NOTES:

1. DIMENSIONING AND TOLERANCING PER ANSI Y14.5M, 1982.
2. CONTROLLING DIMENSION: INCHES.
3. DIMENSION Z DEFINES A ZONE WHERE ALL BODY AND LEAD IRREGULARITIES ARE ALLOWED.
4. PRODUCT SHIPPED PRIOR TO 2008 HAD DIMENSIONS S = 0.045 - 0.055 INCHES (1.143 - 1.397 MM)

| DIM | INCHES |       | MILLIMETERS |       |
|-----|--------|-------|-------------|-------|
|     | MIN    | MAX   | MIN         | MAX   |
| A   | 0.570  | 0.620 | 14.48       | 15.75 |
| B   | 0.380  | 0.405 | 9.66        | 10.28 |
| C   | 0.160  | 0.190 | 4.07        | 4.82  |
| D   | 0.025  | 0.035 | 0.64        | 0.88  |
| F   | 0.142  | 0.147 | 3.61        | 3.73  |
| G   | 0.095  | 0.105 | 2.42        | 2.66  |
| H   | 0.110  | 0.155 | 2.80        | 3.93  |
| J   | 0.018  | 0.025 | 0.46        | 0.64  |
| K   | 0.500  | 0.562 | 12.70       | 14.27 |
| L   | 0.045  | 0.060 | 1.15        | 1.52  |
| N   | 0.190  | 0.210 | 4.83        | 5.33  |
| Q   | 0.100  | 0.120 | 2.54        | 3.04  |
| R   | 0.080  | 0.110 | 2.04        | 2.79  |
| S   | 0.020  | 0.024 | 0.508       | 0.61  |
| T   | 0.235  | 0.255 | 5.97        | 6.47  |
| U   | 0.000  | 0.050 | 0.00        | 1.27  |
| V   | 0.045  | ---   | 1.15        | ---   |
| Z   | ---    | 0.080 | ---         | 2.04  |

STYLE 1:

- PIN 1. BASE  
2. COLLECTOR  
3. EMITTER  
4. COLLECTOR

STYLE 2:

- PIN 1. BASE  
2. EMITTER  
3. COLLECTOR  
4. EMITTER

STYLE 3:

- PIN 1. CATHODE  
2. ANODE  
3. GATE  
4. ANODE

STYLE 4:

- PIN 1. MAIN TERMINAL 1  
2. MAIN TERMINAL 2  
3. GATE  
4. MAIN TERMINAL 2

STYLE 5:

- PIN 1. GATE  
2. DRAIN  
3. SOURCE  
4. DRAIN

STYLE 6:

- PIN 1. ANODE  
2. CATHODE  
3. ANODE  
4. CATHODE

STYLE 7:

- PIN 1. CATHODE  
2. ANODE  
3. CATHODE  
4. ANODE

STYLE 8:

- PIN 1. CATHODE  
2. ANODE  
3. EXTERNAL TRIP/DELAY  
4. ANODE

STYLE 9:

- PIN 1. GATE  
2. COLLECTOR  
3. EMITTER  
4. COLLECTOR

STYLE 10:

- PIN 1. GATE  
2. SOURCE  
3. DRAIN  
4. SOURCE

STYLE 11:

- PIN 1. DRAIN  
2. SOURCE  
3. GATE  
4. SOURCE

|                         |                             |   |
|-------------------------|-----------------------------|---|
| <b>DOCUMENT NUMBER:</b> | <b>98AON23085D</b>          | Electronic versions are uncontrolled except when accessed directly from the Document Repository.<br>Printed versions are uncontrolled except when stamped "CONTROLLED COPY" in red. |
| <b>DESCRIPTION:</b>     | <b>TO-220, SINGLE GAUGE</b> | <b>PAGE 1 OF 1</b>  |

ON Semiconductor and are trademarks of Semiconductor Components Industries, LLC dba ON Semiconductor or its subsidiaries in the United States and/or other countries. ON Semiconductor reserves the right to make changes without further notice to any products herein. ON Semiconductor makes no warranty, representation or guarantee regarding the suitability of its products for any particular purpose, nor does ON Semiconductor assume any liability arising out of the application or use of any product or circuit, and specifically disclaims any and all liability, including without limitation special, consequential or incidental damages. ON Semiconductor does not convey any license under its patent rights nor the rights of others.



# MECHANICAL CASE OUTLINE

## PACKAGE DIMENSIONS

ON Semiconductor®

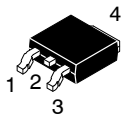

SCALE 1:1

### DPAK (SINGLE GAUGE)

#### CASE 369C

#### ISSUE F

DATE 21 JUL 2015



NOTES:

1. DIMENSIONING AND TOLERANCING PER ASME Y14.5M, 1994.
2. CONTROLLING DIMENSION: INCHES.
3. THERMAL PAD CONTOUR OPTIONAL WITHIN DIMENSIONS b3, L3 and Z.
4. DIMENSIONS D AND E DO NOT INCLUDE MOLD FLASH, PROTRUSIONS, OR BURRS. MOLD FLASH, PROTRUSIONS, OR GATE BURRS SHALL NOT EXCEED 0.006 INCHES PER SIDE.
5. DIMENSIONS D AND E ARE DETERMINED AT THE OUTERMOST EXTREMES OF THE PLASTIC BODY.
6. DATUMS A AND B ARE DETERMINED AT DATUM PLANE H.
7. OPTIONAL MOLD FEATURE.

| DIM | INCHES    |       | MILLIMETERS |       |
|-----|-----------|-------|-------------|-------|
|     | MIN       | MAX   | MIN         | MAX   |
| A   | 0.086     | 0.094 | 2.18        | 2.38  |
| A1  | 0.000     | 0.005 | 0.00        | 0.13  |
| b   | 0.025     | 0.035 | 0.63        | 0.89  |
| b2  | 0.028     | 0.045 | 0.72        | 1.14  |
| b3  | 0.180     | 0.215 | 4.57        | 5.46  |
| c   | 0.018     | 0.024 | 0.46        | 0.61  |
| c2  | 0.018     | 0.024 | 0.46        | 0.61  |
| D   | 0.235     | 0.245 | 5.97        | 6.22  |
| E   | 0.250     | 0.265 | 6.35        | 6.73  |
| e   | 0.090 BSC |       | 2.29 BSC    |       |
| H   | 0.370     | 0.410 | 9.40        | 10.41 |
| L   | 0.055     | 0.070 | 1.40        | 1.78  |
| L1  | 0.114 REF |       | 2.90 REF    |       |
| L2  | 0.020 BSC |       | 0.51 BSC    |       |
| L3  | 0.035     | 0.050 | 0.89        | 1.27  |
| L4  | ---       | 0.040 | ---         | 1.01  |
| Z   | 0.155     | ---   | 3.93        | ---   |

### GENERIC MARKING DIAGRAM\*

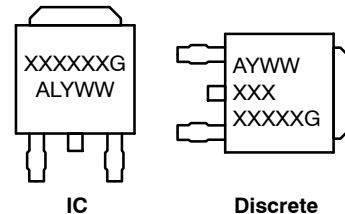

- XXXXXX = Device Code
- A = Assembly Location
- L = Wafer Lot
- Y = Year
- WW = Work Week
- G = Pb-Free Package

\*This information is generic. Please refer to device data sheet for actual part marking.

- |  |  |   |   |  |
|--|--|---|---|--|
| <p>STYLE 1:<br/>PIN 1. BASE<br/>2. COLLECTOR<br/>3. EMITTER<br/>4. COLLECTOR</p> | <p>STYLE 2:<br/>PIN 1. GATE<br/>2. DRAIN<br/>3. SOURCE<br/>4. DRAIN</p>          | <p>STYLE 3:<br/>PIN 1. ANODE<br/>2. CATHODE<br/>3. ANODE<br/>4. CATHODE</p> | <p>STYLE 4:<br/>PIN 1. CATHODE<br/>2. ANODE<br/>3. GATE<br/>4. ANODE</p>              | <p>STYLE 5:<br/>PIN 1. GATE<br/>2. ANODE<br/>3. CATHODE<br/>4. ANODE</p>     |
| <p>STYLE 6:<br/>PIN 1. MT1<br/>2. MT2<br/>3. GATE<br/>4. MT2</p>                 | <p>STYLE 7:<br/>PIN 1. GATE<br/>2. COLLECTOR<br/>3. EMITTER<br/>4. COLLECTOR</p> | <p>STYLE 8:<br/>PIN 1. N/C<br/>2. CATHODE<br/>3. ANODE<br/>4. CATHODE</p>   | <p>STYLE 9:<br/>PIN 1. ANODE<br/>2. CATHODE<br/>3. RESISTOR ADJUST<br/>4. CATHODE</p> | <p>STYLE 10:<br/>PIN 1. CATHODE<br/>2. ANODE<br/>3. CATHODE<br/>4. ANODE</p> |

### SOLDERING FOOTPRINT\*

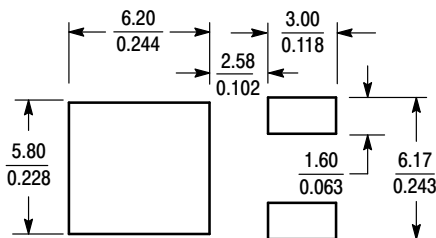

SCALE 3:1 (mm / inches)

\*For additional information on our Pb-Free strategy and soldering details, please download the ON Semiconductor Soldering and Mounting Techniques Reference Manual, SOLDERRM/D.

|                  |                     |  |
|------------------|---------------------|--|
| DOCUMENT NUMBER: | 98AON10527D         | Electronic versions are uncontrolled except when accessed directly from the Document Repository. Printed versions are uncontrolled except when stamped "CONTROLLED COPY" in red. |
| DESCRIPTION:     | DPAK (SINGLE GAUGE) | PAGE 1 OF 1  |

ON Semiconductor and ON are trademarks of Semiconductor Components Industries, LLC dba ON Semiconductor or its subsidiaries in the United States and/or other countries. ON Semiconductor reserves the right to make changes without further notice to any products herein. ON Semiconductor makes no warranty, representation or guarantee regarding the suitability of its products for any particular purpose, nor does ON Semiconductor assume any liability arising out of the application or use of any product or circuit, and specifically disclaims any and all liability, including without limitation special, consequential or incidental damages. ON Semiconductor does not convey any license under its patent rights nor the rights of others.

# MECHANICAL CASE OUTLINE

## PACKAGE DIMENSIONS

ON Semiconductor®



SCALE 1:1

**D<sup>2</sup>PAK**  
CASE 936-03  
ISSUE E

DATE 29 SEP 2015



**NOTES:**

1. DIMENSIONING AND TOLERANCING PER ANSI Y14.5M, 1982.
2. CONTROLLING DIMENSION: INCHES.
3. TAB CONTOUR OPTIONAL WITHIN DIMENSIONS A AND K.
4. DIMENSIONS U AND V ESTABLISH A MINIMUM MOUNTING SURFACE FOR TERMINAL 4.
5. DIMENSIONS A AND B DO NOT INCLUDE MOLD FLASH OR GATE PROTRUSIONS. MOLD FLASH AND GATE PROTRUSIONS NOT TO EXCEED 0.025 (0.635) MAXIMUM.
6. SINGLE GAUGE DESIGN WILL BE SHIPPED AFTER FPCN EXPIRATION IN OCTOBER 2011.

| DIM            | INCHES    |       | MILLIMETERS |        |
|----------------|-----------|-------|-------------|--------|
|                | MIN       | MAX   | MIN         | MAX    |
| A              | 0.386     | 0.403 | 9.804       | 10.236 |
| B              | 0.356     | 0.368 | 9.042       | 9.347  |
| C              | 0.170     | 0.180 | 4.318       | 4.572  |
| D              | 0.026     | 0.036 | 0.660       | 0.914  |
| E <sub>D</sub> | 0.045     | 0.055 | 1.143       | 1.397  |
| E <sub>S</sub> | 0.018     | 0.026 | 0.457       | 0.660  |
| F              | 0.051 REF |       | 1.295 REF   |        |
| G              | 0.100 BSC |       | 2.540 BSC   |        |
| H              | 0.539     | 0.579 | 13.691      | 14.707 |
| J              | 0.125 MAX |       | 3.175 MAX   |        |
| K              | 0.050 REF |       | 1.270 REF   |        |
| L              | 0.000     | 0.010 | 0.000       | 0.254  |
| M              | 0.088     | 0.102 | 2.235       | 2.591  |
| N              | 0.018     | 0.026 | 0.457       | 0.660  |
| P              | 0.058     | 0.078 | 1.473       | 1.981  |
| R              | 0°        | 8°    | 0°          | 8°     |
| S              | 0.116 REF |       | 2.946 REF   |        |
| U              | 0.200 MIN |       | 5.080 MIN   |        |
| V              | 0.250 MIN |       | 6.350 MIN   |        |

**SOLDERING FOOTPRINT\***



DIMENSIONS: MILLIMETERS

\*For additional information on our Pb-Free strategy and soldering details, please download the ON Semiconductor Soldering and Mounting Techniques Reference Manual, SOLDERRM/D.

**GENERIC MARKING DIAGRAM\***



- XXXXXX = Specific Device Code
- A = Assembly Location
- L = Wafer Lot
- Y = Year
- WW = Work Week
- G = Pb-Free Package

\*This information is generic. Please refer to device data sheet for actual part marking. Pb-Free indicator, "G" or microdot "▪", may or may not be present.

|                         |                         |  |
|-------------------------|-------------------------|--|
| <b>DOCUMENT NUMBER:</b> | <b>98ASH01005A</b>      | Electronic versions are uncontrolled except when accessed directly from the Document Repository. Printed versions are uncontrolled except when stamped "CONTROLLED COPY" in red. |
| <b>DESCRIPTION:</b>     | <b>D<sup>2</sup>PAK</b> | <b>PAGE 1 OF 1</b>   |

ON Semiconductor and ON are trademarks of Semiconductor Components Industries, LLC dba ON Semiconductor or its subsidiaries in the United States and/or other countries. ON Semiconductor reserves the right to make changes without further notice to any products herein. ON Semiconductor makes no warranty, representation or guarantee regarding the suitability of its products for any particular purpose, nor does ON Semiconductor assume any liability arising out of the application or use of any product or circuit, and specifically disclaims any and all liability, including without limitation special, consequential or incidental damages. ON Semiconductor does not convey any license under its patent rights nor the rights of others.

**onsemi**, **Onsemi**, and other names, marks, and brands are registered and/or common law trademarks of Semiconductor Components Industries, LLC dba "**onsemi**" or its affiliates and/or subsidiaries in the United States and/or other countries. **onsemi** owns the rights to a number of patents, trademarks, copyrights, trade secrets, and other intellectual property. A listing of **onsemi**'s product/patent coverage may be accessed at [www.onsemi.com/site/pdf/Patent-Marking.pdf](http://www.onsemi.com/site/pdf/Patent-Marking.pdf). **onsemi** reserves the right to make changes at any time to any products or information herein, without notice. The information herein is provided "as-is" and **onsemi** makes no warranty, representation or guarantee regarding the accuracy of the information, product features, availability, functionality, or suitability of its products for any particular purpose, nor does **onsemi** assume any liability arising out of the application or use of any product or circuit, and specifically disclaims any and all liability, including without limitation special, consequential or incidental damages. Buyer is responsible for its products and applications using **onsemi** products, including compliance with all laws, regulations and safety requirements or standards, regardless of any support or applications information provided by **onsemi**. "Typical" parameters which may be provided in **onsemi** data sheets and/or specifications can and do vary in different applications and actual performance may vary over time. All operating parameters, including "Typicals" must be validated for each customer application by customer's technical experts. **onsemi** does not convey any license under any of its intellectual property rights nor the rights of others. **onsemi** products are not designed, intended, or authorized for use as a critical component in life support systems or any FDA Class 3 medical devices or medical devices with a same or similar classification in a foreign jurisdiction or any devices intended for implantation in the human body. Should Buyer purchase or use **onsemi** products for any such unintended or unauthorized application, Buyer shall indemnify and hold **onsemi** and its officers, employees, subsidiaries, affiliates, and distributors harmless against all claims, costs, damages, and expenses, and reasonable attorney fees arising out of, directly or indirectly, any claim of personal injury or death associated with such unintended or unauthorized use, even if such claim alleges that **onsemi** was negligent regarding the design or manufacture of the part. **onsemi** is an Equal Opportunity/Affirmative Action Employer. This literature is subject to all applicable copyright laws and is not for resale in any manner.

## PUBLICATION ORDERING INFORMATION

### LITERATURE FULFILLMENT:

Email Requests to: [orderlit@onsemi.com](mailto:orderlit@onsemi.com)

**onsemi Website:** [www.onsemi.com](http://www.onsemi.com)

### TECHNICAL SUPPORT

**North American Technical Support:**  
Voice Mail: 1 800-282-9855 Toll Free USA/Canada  
Phone: 011 421 33 790 2910

**Europe, Middle East and Africa Technical Support:**

Phone: 00421 33 790 2910

For additional information, please contact your local Sales Representative

# Mouser Electronics

Authorized Distributor

Click to View Pricing, Inventory, Delivery & Lifecycle Information:

[onsemi:](#)

[NCV7805BD2T](#) [NCV7805BD2TG](#) [NCV7805BD2TR4](#) [NCV7805BD2TR4G](#) [NCV7805BT](#) [NCV7805BTG](#)  
[MC7805ABD2TG](#) [MC7805ABD2TR4G](#) [MC7805ABTG](#) [MC7805ACD2TG](#) [MC7805ACD2TR4G](#) [MC7805ACTG](#)  
[MC7805BD2TG](#) [MC7805BD2TR4G](#) [MC7805BDTG](#) [MC7805BDTRKG](#) [MC7805BTG](#) [MC7805CD2TG](#)  
[MC7805CD2TR4G](#) [MC7805CDTG](#) [MC7805CDTRKG](#) [MC7805CTG](#) [MC7806ACTG](#) [MC7806BD2TG](#)  
[MC7806BD2TR4G](#) [MC7806BTG](#) [MC7806CTG](#) [MC7808ABD2TG](#) [MC7808ABD2TR4G](#) [MC7808ABTG](#)  
[MC7808ACTG](#) [MC7808BD2TG](#) [MC7808BD2TR4G](#) [MC7808BDTG](#) [MC7808BDTRKG](#) [MC7808BTG](#) [MC7808CD2TG](#)  
[MC7808CD2TR4G](#) [MC7808CDTG](#) [MC7808CDTRKG](#) [MC7808CTG](#) [MC7809ACT](#) [MC7809ACTG](#) [MC7809BTG](#)  
[MC7809CD2TG](#) [MC7809CD2TR4G](#) [MC7809CTG](#) [MC7812ABD2TG](#) [MC7812ABD2TR4G](#) [MC7812ABTG](#)  
[MC7812ACD2TG](#) [MC7812ACD2TR4G](#) [MC7812ACTG](#) [MC7812BD2TG](#) [MC7812BD2TR4G](#) [MC7812BDTG](#)  
[MC7812BDTRKG](#) [MC7812BTG](#) [MC7812CD2TG](#) [MC7812CD2TR4G](#) [MC7812CDTG](#) [MC7812CDTRKG](#) [MC7812CTG](#)  
[MC7815ABD2TG](#) [MC7815ABD2TR4G](#) [MC7815ABTG](#) [MC7815ACT](#) [MC7815ACTG](#) [MC7815BD2TG](#)  
[MC7815BD2TR4G](#) [MC7815BDTG](#) [MC7815BDTRKG](#) [MC7815BTG](#) [MC7815CD2TG](#) [MC7815CD2TR4G](#)  
[MC7815CDTG](#) [MC7815CDTRKG](#) [MC7815CTG](#) [MC7818ACT](#) [MC7818ACTG](#) [MC7818BTG](#) [MC7818CD2TR4G](#)  
[MC7818CT](#) [MC7818CTG](#) [MC7824ACT](#) [MC7824ACTG](#) [MC7824BD2TG](#) [MC7824BD2TR4G](#) [MC7824BTG](#)  
[MC7824CD2TG](#) [MC7824CD2TR4G](#) [MC7824CTG](#) [MC7808CDTT5G](#) [MC7815ACD2TG](#) [NCV7808BD2TR4](#)  
[NCV7808BD2TR4G](#) [NCV7808BDTG](#) [NCV7808BTG](#) [NCV7815BTG](#) [NCV7805ABD2TR4G](#)