

## Electrical Characteristics (@TA=25°C unless otherwise noted)

Parameter	Symbol	Conditions	Min.	Max.	Units
Collector-Base breakdown voltage	$V_{(BR)CBO}$	$I_C = -10\mu A, I_E = 0$	-60		V
Collector-Emitter breakdown voltage (Note 1)	$V_{(BR)CEO}$	$I_C = -10mA, I_B = 0$	-60		V
Emitter-Base breakdown voltage	$V_{(BR)EBO}$	$I_E = -10\mu A, I_C = 0$	-5		V
Collector cut-off current	$I_{CBO}$	$V_{CB} = -50V, I_E = 0$		-20	nA
Base cut-off current	$I_{EBO}$	$V_{EB} = -3V, I_C = 0$		-10	nA
Collector cut-off current	$I_{CEX}$	$V_{CE} = -30V, V_{BE(off)} = -0.5V$		-50	nA
DC current gain	$h_{FE(1)}$	$V_{CE} = -10V, I_C = -150mA$	100	300	
	$h_{FE(2)}$	$V_{CE} = -10V, I_C = -0.1mA$	75		
	$h_{FE(3)}$	$V_{CE} = -10V, I_C = -1mA$	100		
	$h_{FE(4)}$	$V_{CE} = -10V, I_C = -10mA$	100		
	$h_{FE(5)}$	$V_{CE} = -10V, I_C = -500mA$	50		
Collector-Emitter saturation voltage (Note 1)	$V_{CE(sat)}$	$I_C = -150mA, I_B = -15mA$ $I_C = -500mA, I_B = -50mA$		-0.4 -1.6	V
Base-Emitter saturation voltage (Note 1)	$V_{BE(sat)}$	$I_C = -150mA, I_B = -15mA$ $I_C = -500mA, I_B = -50mA$		-1.3 -2.6	V
Transition frequency	$f_T$	$V_{CE} = -20V, I_C = -50mA$ $f = 100MHz$	200		MHz
Delay time	$t_d$	$V_{CE} = -30V$		10	nS
Rise time	$t_r$	$I_C = -150mA, I_{B1} = -15mA$		25	nS
Storage time	$t_s$	$V_{CE} = -6V, I_C = -150mA$		225	nS
Fall time	$t_f$	$I_{B1} = -I_{B2} = -15mA$		60	nS

Notes:

1. Pulse test: Pulse Width  $\leq 300\mu s$ , Duty Cycle  $\leq 2.0\%$ .

Company reserves the right to improve product design, functions and reliability without notice.

## RATING AND CHARACTERISTIC CURVES (MMBT2907A-G)

Fig.1 - Static Characteristic

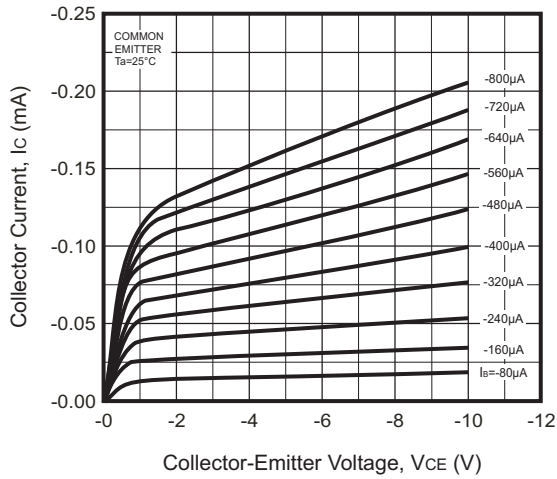

Fig.2 - hFE — Ic

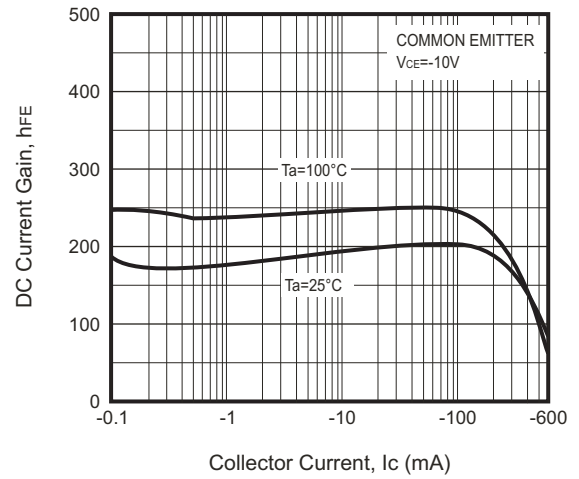

Fig.3 - VCEsat — Ic

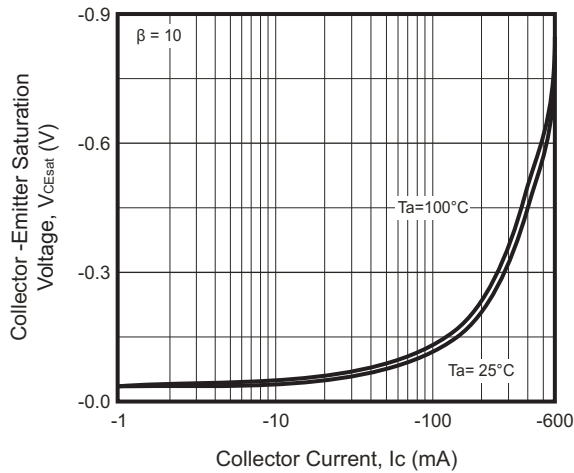
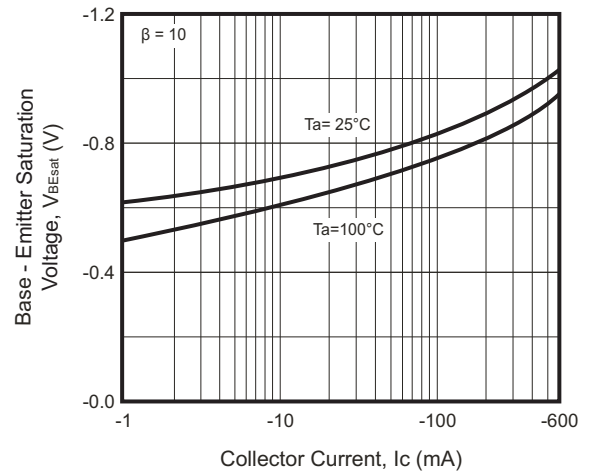

Fig.4 - VBEsat — Ic



Company reserves the right to improve product design , functions and reliability without notice.

## RATING AND CHARACTERISTIC CURVES (MMBT2907A-G)

Fig.5 -  $I_c$  —  $V_{BE}$

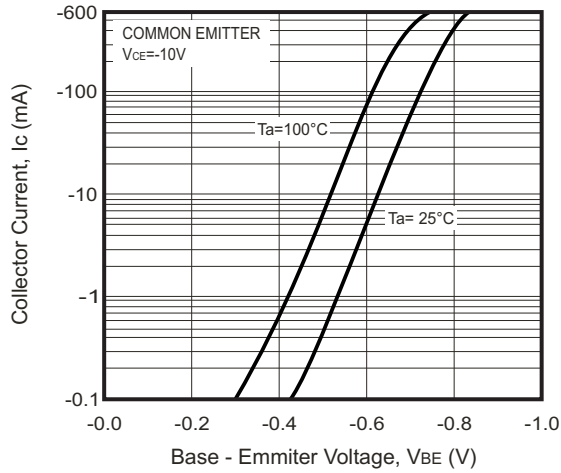

Fig.6 -  $C_{ob}/C_{ib}$  —  $V_{CB}/V_{EB}$

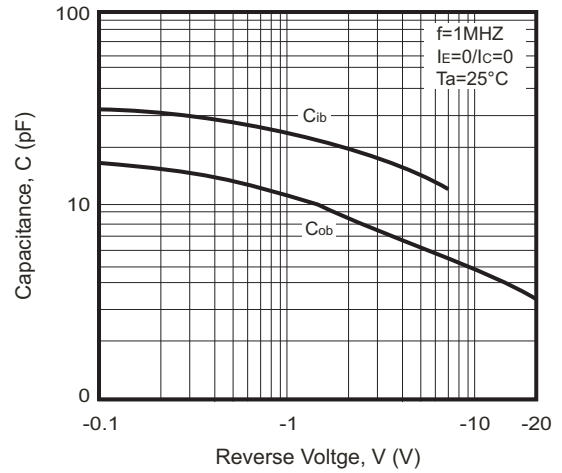
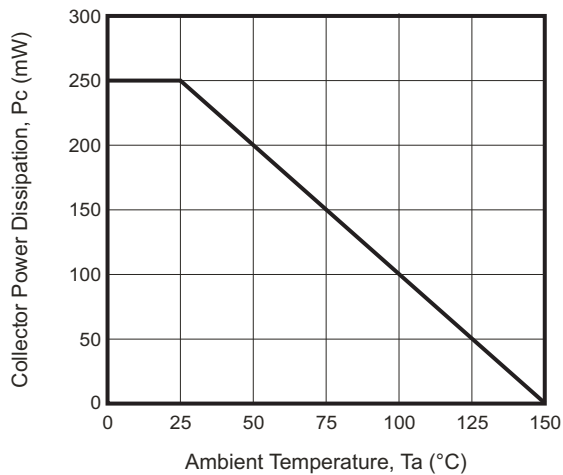
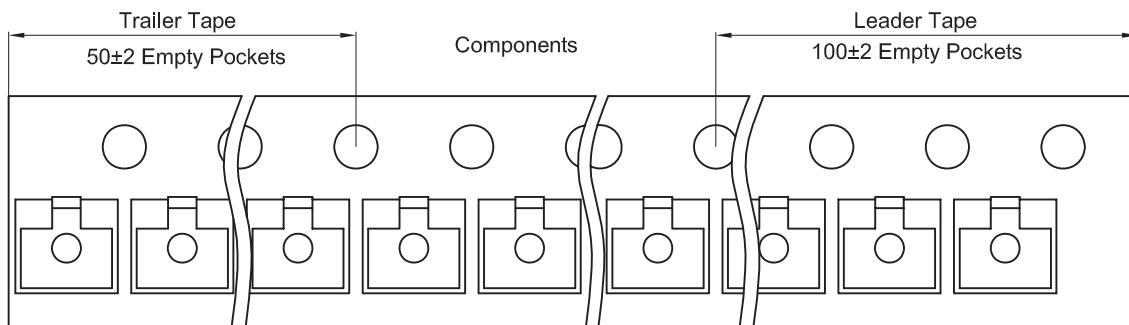
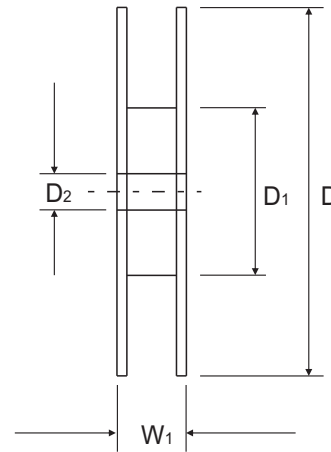
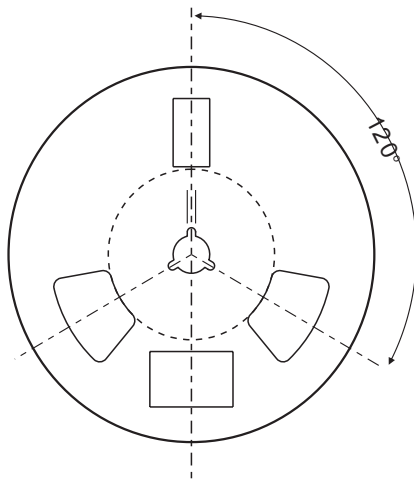
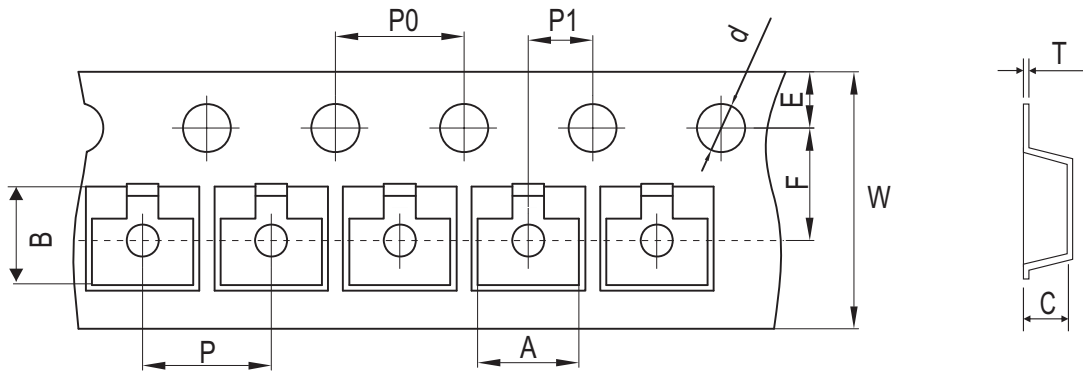

Fig.7 -  $P_c$  —  $T_a$



Company reserves the right to improve product design , functions and reliability without notice.

## Reel Taping Specification



SOT-23	SYMBOL	A	B	C	d	D	D1	D2
	(mm)	3.15 ± 0.10	2.77 ± 0.10	1.22 ± 0.10	Φ1.50 ± 0.10	178 ± 2.00	54.40 ± 1.00	13.00 ± 1.00
	(inch)	0.124 ± 0.004	0.109 ± 0.004	0.048 ± 0.004	Φ0.059 ± 0.004	7.008 ± 0.079	2.142 ± 0.039	0.512 ± 0.039

SOT-23	SYMBOL	E	F	P	P0	P1	W	W1
	(mm)	1.75 ± 0.10	3.50 ± 0.10	4.00 ± 0.10	4.00 ± 0.10	2.00 ± 0.10	8.00 + 0.30 / - 0.10	12.30 ± 1.00
	(inch)	0.069 ± 0.004	0.138 ± 0.004	0.157 ± 0.004	0.157 ± 0.004	0.079 ± 0.004	0.315 + 0.012 / - 0.004	0.484 ± 0.039

Company reserves the right to improve product design , functions and reliability without notice.

## Marking Code

Part Number	Marking Code
MMBT2907A-G	2F

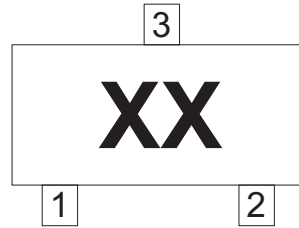

xx = Product type marking code

## Suggested PAD Layout

SIZE	SOT-23	
	(mm)	(inch)
A	0.80	0.031
B	1.90	0.075
C	2.02	0.080
D	2.82	0.111

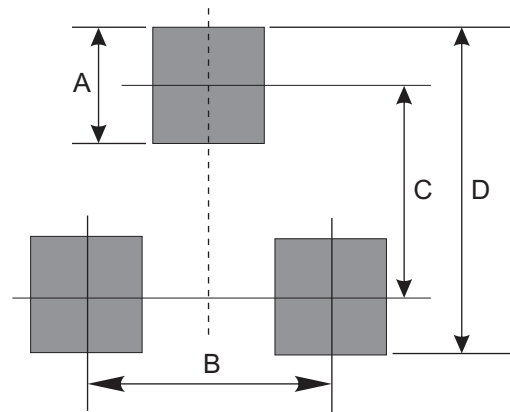

## Standard Packaging

Case Type	REEL PACK	
	REEL ( pcs )	Reel Size (inch)
SOT-23	3,000	7

Company reserves the right to improve product design , functions and reliability without notice.

# Mouser Electronics

Authorized Distributor

Click to View Pricing, Inventory, Delivery & Lifecycle Information:

[Comchip Technology:](#)

[MMBT2907A-G](#)