



<b>ELECTRICAL CHARACTERISTICS</b> ( $T_C = 25\text{ }^\circ\text{C}$ unless otherwise noted)								
PARAMETER	TEST CONDITIONS		SYMBOL	BYV32-50	BYV32-100	BYV32-150	BYV32-200	UNIT
Maximum instantaneous forward voltage per diode	$I_F = 20\text{ A}$	$T_J = 25\text{ }^\circ\text{C}$	$V_F^{(1)}$	1.15				V
	$I_F = 5.0\text{ A}$	$T_J = 100\text{ }^\circ\text{C}$		0.85				
Maximum DC reverse current per diode at rated DC blocking voltage			$I_R$	10				$\mu\text{A}$
				600				
Maximum reverse recovery time per diode	$I_F = 1\text{ A}$ , $V_R = 30\text{ V}$ $di/dt = 100\text{ A}/\mu\text{s}$ , $I_{rr} = 10\% I_{RM}$		$t_{rr}$	25				ns
Typical junction capacitance per diode	4.0 V, 1 MHz		$C_J$	45				pF

**Note**(1) Pulse test: 300  $\mu\text{s}$  pulse width, 1 % duty cycle

<b>THERMAL CHARACTERISTICS</b> ( $T_C = 25\text{ }^\circ\text{C}$ unless otherwise noted)					
PARAMETER	SYMBOL	BYV	BYVF	BYVB	UNIT
Typical thermal resistance from junction to case per diode	$R_{\theta JC}$	1.6	5.0	1.6	$^\circ\text{C}/\text{W}$

<b>ORDERING INFORMATION</b> (Example)					
PACKAGE	PREFERRED P/N	UNIT WEIGHT (g)	PACKAGE CODE	BASE QUANTITY	DELIVERY MODE
TO-220AB	BYV32-200-E3/45	1.85	45	50/tube	Tube
ITO-220AB	BYVF32-200-E3/45	1.97	45	50/tube	Tube
TO-263AB	BYVB32-200-E3/45	1.35	45	50/tube	Tube
TO-263AB	BYVB32-200-E3/81	1.35	81	800/reel	Tape and reel
ITO-220AB	BYVF32-200HE3_A/P <sup>(1)</sup>	1.97	P	50/tube	Tube
TO-263AB	BYVB32-200HE3_A/P <sup>(1)</sup>	1.35	P	50/tube	Tube
TO-263AB	BYVB32-200HE3_A/I <sup>(1)</sup>	1.35	I	800/reel	Tape and reel

**Note**

(1) AEC-Q101 qualified, available in ITO-220AB and TO-263AB package



RATINGS AND CHARACTERISTICS CURVES (T<sub>A</sub> = 25 °C unless otherwise noted)

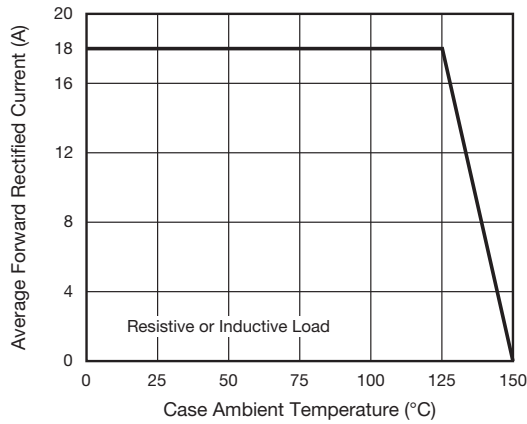

Fig. 1 - Forward Current Derating Curve

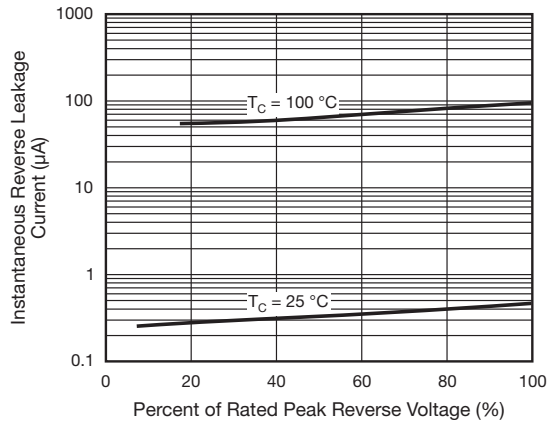

Fig. 4 - Typical Reverse Leakage Characteristics Per Diode

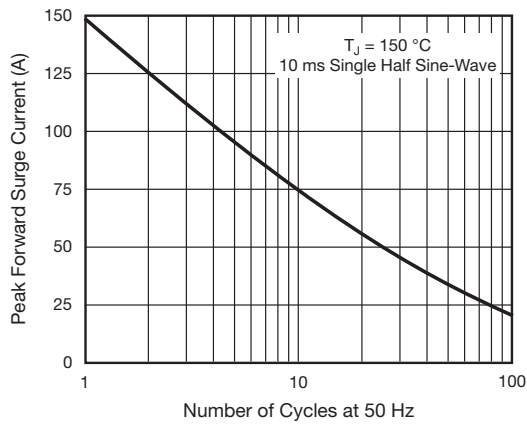

Fig. 2 - Maximum Non-Repetitive Peak Forward Surge Current Per Diode

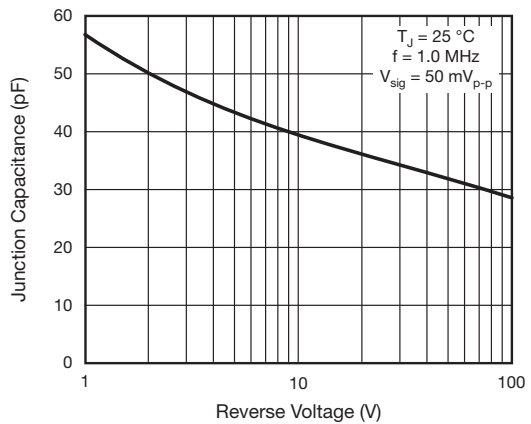

Fig. 5 - Typical Junction Capacitance Per Diode

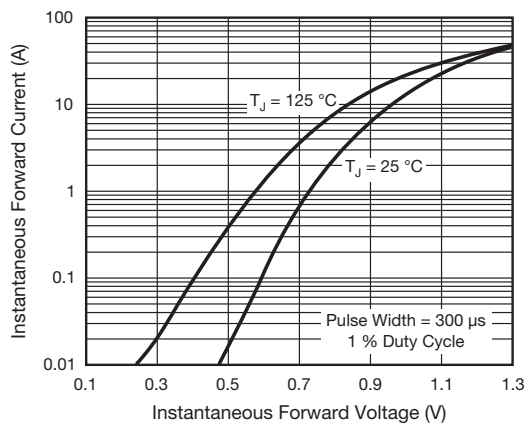
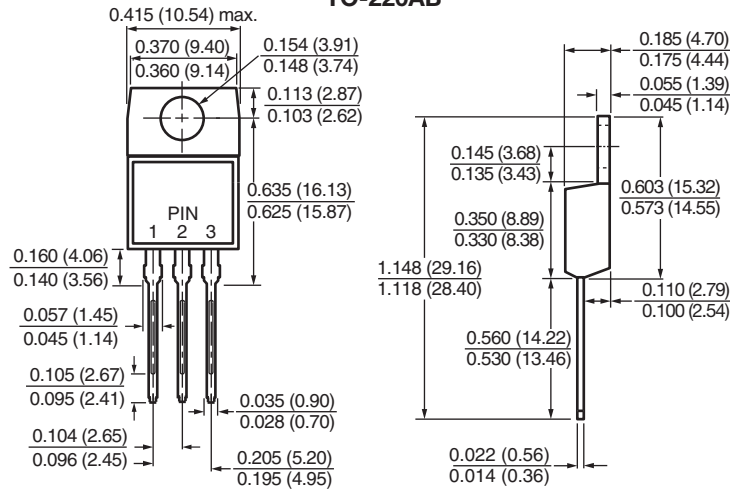

Fig. 3 - Typical Instantaneous Forward Characteristics Per Diode



PACKAGE OUTLINE DIMENSIONS in inches (millimeters)

TO-220AB



ITO-220AB

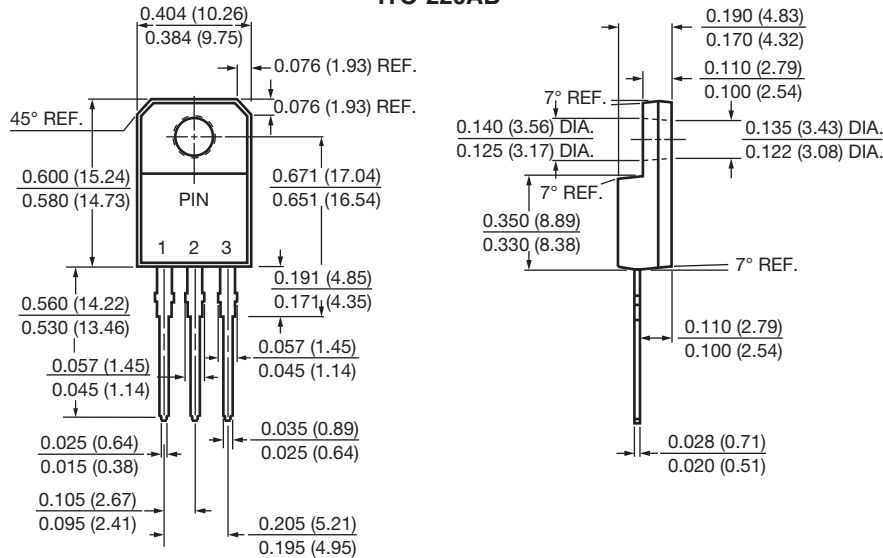

D<sup>2</sup>PAK (TO-263AB)

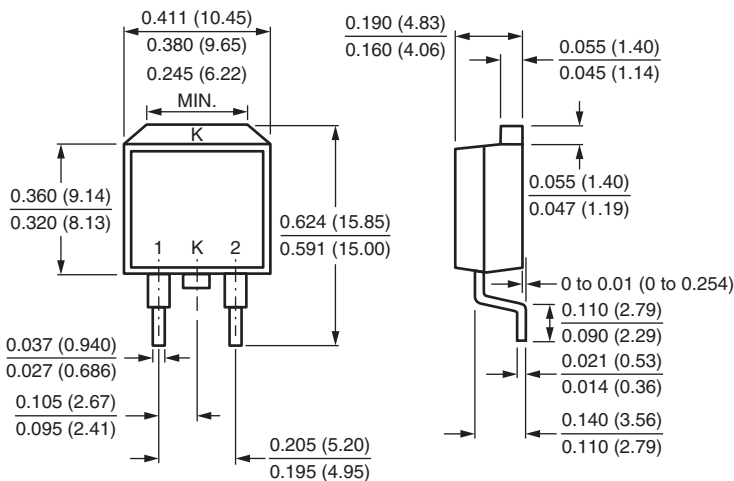

Mounting Pad Layout

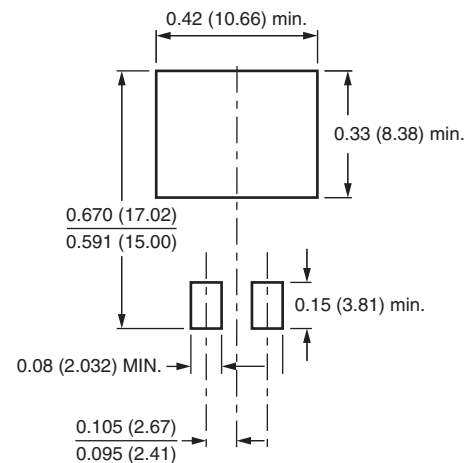



## Disclaimer

ALL PRODUCT, PRODUCT SPECIFICATIONS AND DATA ARE SUBJECT TO CHANGE WITHOUT NOTICE TO IMPROVE RELIABILITY, FUNCTION OR DESIGN OR OTHERWISE.

Vishay Intertechnology, Inc., its affiliates, agents, and employees, and all persons acting on its or their behalf (collectively, "Vishay"), disclaim any and all liability for any errors, inaccuracies or incompleteness contained in any datasheet or in any other disclosure relating to any product.

Vishay makes no warranty, representation or guarantee regarding the suitability of the products for any particular purpose or the continuing production of any product. To the maximum extent permitted by applicable law, Vishay disclaims (i) any and all liability arising out of the application or use of any product, (ii) any and all liability, including without limitation special, consequential or incidental damages, and (iii) any and all implied warranties, including warranties of fitness for particular purpose, non-infringement and merchantability.

Statements regarding the suitability of products for certain types of applications are based on Vishay's knowledge of typical requirements that are often placed on Vishay products in generic applications. Such statements are not binding statements about the suitability of products for a particular application. It is the customer's responsibility to validate that a particular product with the properties described in the product specification is suitable for use in a particular application. Parameters provided in datasheets and / or specifications may vary in different applications and performance may vary over time. All operating parameters, including typical parameters, must be validated for each customer application by the customer's technical experts. Product specifications do not expand or otherwise modify Vishay's terms and conditions of purchase, including but not limited to the warranty expressed therein.

Except as expressly indicated in writing, Vishay products are not designed for use in medical, life-saving, or life-sustaining applications or for any other application in which the failure of the Vishay product could result in personal injury or death. Customers using or selling Vishay products not expressly indicated for use in such applications do so at their own risk. Please contact authorized Vishay personnel to obtain written terms and conditions regarding products designed for such applications.

No license, express or implied, by estoppel or otherwise, to any intellectual property rights is granted by this document or by any conduct of Vishay. Product names and markings noted herein may be trademarks of their respective owners.

# Mouser Electronics

Authorized Distributor

Click to View Pricing, Inventory, Delivery & Lifecycle Information:

[Vishay:](#)

[BYV32-100-E3/45](#) [BYV32-150-E3/45](#) [BYV32-200-E3/45](#) [BYV32-50-E3/45](#) [BYVB32-100-E3/45](#) [BYVB32-100-E3/81](#)  
[BYVB32-150-E3/81](#) [BYVB32-200-E3/45](#) [BYVB32-200-E3/81](#) [BYVB32-50-E3/45](#) [BYVB32-50-E3/81](#) [BYVF32-100-](#)  
[E3/45](#) [BYVF32-150-E3/45](#) [BYVF32-200-E3/45](#) [BYVF32-50-E3/45](#)