

FAN105AM6X

PIN DESCRIPTION

Pin #	Name	Description
1	CS	<i>Current Sense.</i> This pin connects to a current-sense resistor to detect the MOSFET current for Peak-Current-Mode control for output regulation. The current-sense information is also used to estimate the output current for CC regulation.
2	GND	<i>Ground</i>
3	GATE	<i>PWM Signal Output.</i> This pin has an internal totem-pole output driver to drive the power MOSFET. The gate driving voltage is internally clamped at 7.5 V.
4	VDD	<i>Power Supply.</i> IC operating current and MOSFET driving current are supplied through this pin. This pin is typically connected to an external V _{DD} capacitor.
5	VS	<i>Voltage Sense.</i> This pin detects the output voltage information and diode current discharge time based on the voltage of auxiliary winding. It also senses sink current through the auxiliary winding to detect input voltage information.
6	AUX	<i>Auxiliary Function.</i> This pin generates one voltage level proportional to output current to compensate output voltage drop due to cable resistance. The pin is also used for startup with external HV FET. Integrated Dynamic Response Enhancement (DRE) function through secondary feedback signal.

MAXIMUM RATINGS (Note 1, 2, 3)

Parameter	Symbol	Min	Max	Unit
DC Supply Voltage	V _{VDD}	-0.3	30	V
AUX Pin Input Voltage	V _{AUX}	-0.3	30	V
VS Pin Input Voltage	V _{VS}	-0.3	6.0	V
CS Pin Input Voltage	V _{CS}	-0.3	6.0	V
Power Dissipation (T _A = 25°C)	P _D	-	0.391	mW
Operating Junction Temperature	T _J	-40	+150	°C
Storage Temperature Range	T _{STG}	-60	+150	°C
Lead Temperature (Soldering, 10 Seconds)	T _L	-	+260	°C
Electrostatic Discharge Capability	Human Body Model, ANSI/ESDA/JEDEC, JESD22_A114	ESD	>1.5	kV
	Charged Device Model, JEDEC:JESD22_C101		>0.5	

Stresses exceeding those listed in the Maximum Ratings table may damage the device. If any of these limits are exceeded, device functionality should not be assumed, damage may occur and reliability may be affected.

1. All voltage values, except differential voltages, are given with respect to the GND pin.
2. Stresses beyond those listed under Absolute Maximum Ratings may cause permanent damage to the device.
3. Meets JEDEC standards JS-001-2012 and JESD 22-C101.

THERMAL CHARACTERISTICS (T_A = 25°C unless otherwise specified)

Parameter	Symbol	Value	Value	Unit
Junction-to-Ambient Thermal Impedance	θ _{JA}	-	242	°C/W
Junction-to-Top Thermal Impedance	θ _{JT}	-	56	°C/W

RECOMMENDED OPERATING CONDITIONS

Parameter	Symbol	Min	Max	Unit
CS Pin Input Voltage	V _{CS}	0	0.8	V
Gate Pin Input Voltage	V _{GATE}	0	8.0	V
VDD Pin Input Voltage	V _{VDD}	7.0	25	V
VS Pin Input Voltage	V _{VS}	1.6	3.2	V
AUX Pin Input Voltage	V _{AUX}	5.0	25	V

Functional operation above the stresses listed in the Recommended Operating Ranges is not implied. Extended exposure to stresses beyond the Recommended Operating Ranges limits may affect device reliability.

FAN105AM6X

ELECTRICAL CHARACTERISTICS ($V_{DD} = 12\text{ V}$ and $T_A = -40\text{--}85^\circ\text{C}$ unless noted)

Parameter	Test Condition	Symbol	Min	Typ	Max	Unit
VDD SECTION						
Turn-On Threshold Voltage		V_{DD-ON}	16.5	17.5	18.5	V
Turn-Off Threshold Voltage		V_{DD-OFF}	6.1	6.5	6.9	V
V_{DD} Over-Voltage-Protection Level		V_{DD-OVP}	26.5	28.0	29.5	V
V_{DD} Over-Voltage-Protection De-bounce Time		$t_{D-VDD-OVP}$	–	120	200	μs
Startup Current (Note 5)		I_{DD-ST}	–	–	20	μA
Operating Current		I_{DD-OP}	1	1.4	1.7	mA
Deep Green-Mode Operating Current		$I_{DD-DPGN}$	375	450	525	μA
OSCILLATOR SECTION						
Maximum Voltage-Mode Quasi-Resonant Blanking Frequency		$f_{OSC-BNK-MAX}$	70	76	82	kHz
Minimum Current-Mode Time-Out Blanking Frequency		$f_{OSC-BNK-MIN}$	4.5	5.0	5.5	kHz
Deep Green Mode Operating Frequency (Note 5)		$f_{OSC-DPGN}$	1.125	1.25	1.375	kHz
Minimum CCM Prevention Frequency (Note 4)		$f_{OSC-CCM-PRVENT}$	18	21	24	kHz
OVER-TEMPERATURE PROTECTION SECTION						
Over-Temperature Protection Threshold (Note 4)		T_{OTP-H}	–	120	–	$^\circ\text{C}$
Over-Temperature Protection Recovery Threshold (Note 4)		T_{OTP-L}	–	100	–	$^\circ\text{C}$
VOLTAGE SAMPLING SECTION						
Reference Voltage of Constant Voltage Feedback		V_{VR}	2.475	2.500	2.525	V
VS Sampling Phase-Shift Resistance (Note 4)		$R_{VS-S/H}$	–	300	–	$\text{k}\Omega$
VS Sampling Phase-Shift Capacitance (Note 4)		$C_{VS-S/H}$	–	5	–	pF
VS Sampling Blanking Time		t_{VS_BNK-L}	1.15	1.30	1.50	μs
VS Sampling Blanking Time to High	I_o over 100 mA	t_{VS_BNK-H}	1.65	1.80	2.00	μs
VS Sampling Blanking Time at CC Controlling		t_{VS_BNK-CC}	2.05	2.20	2.35	μs
VS Discharging Time Judgment Threshold Voltage (Note 4)		$V_{VS-Offset}$	150	200	250	mV
VOLTAGE SENSE SECTION						
Temperature-Independent Bias Current		I_{TC}	9.0	10.0	11.0	μA
VS Pin Source Current Threshold to Enable Brown-Out		$I_{VS-BROWN-OUT}$	260	310	360	μA
Brown-Out De-bounce Time		$t_{D-BROWN-OUT}$	12	17	22	ms
VS Pin Source Current Threshold to Enable Brown-In		$I_{VS-BROWN-IN}$	405	475	545	μA
Brown-In De-bounce Time		$N_{BROWN-IN}$	3	4	5	Cycle
Output Over-Voltage-Protection of V_S Sampling Threshold		V_{VS-OVP}	2.70	2.80	2.90	V
Output Over-Voltage-Protection Debounce Cycle Counts		N_{VS-OVP}	3	4	5	Cycle
Output Low Level Under-Voltage-Protection of V_S Sampling Threshold		V_{VS-UVP}	1.50	1.60	1.70	V
Output Under-Voltage Protection Debounce Time		t_{VS-UVP}	30	40	50	ms

FAN105AM6X

ELECTRICAL CHARACTERISTICS ($V_{DD} = 12\text{ V}$ and $T_A = -40\text{--}85^\circ\text{C}$ unless noted) (continued)

Parameter	Test Condition	Symbol	Min	Typ	Max	Unit
NO-LOAD CONTROL SECTION						
Deep Green Mode Entry Threshold Voltage of COMV (Note 4)		$V_{COMV-CV-DPGN-ENTRY}$	0.4	0.5	0.6	V
Criteria to Enter Deep Green Mode		$V_{VS_EAV_Hi}$	2.550	2.600	2.650	V
Deep Green Mode Band-Band Control High Threshold Voltage		$V_{VS-EAV-H}$	–	2.550	–	V
Deep Green Mode Band-Band Control Low Threshold Voltage		$V_{VS-EAV-L}$	–	2.525	–	V
Criteria to Exit Deep Green Mode		$V_{VS_EAV_Lo}$	2.425	2.450	2.475	V
Dynamic Event Trigger Threshold Voltage in Deep Green Mode		$V_{VS-EAV-DYN}$	2.375	2.400	2.425	V
Minimum On-time at 264 VAC	$C_{GATE} = 1\text{ nF}$	$t_{ON-MIN-264VAC}$	165	200	235	ns
Minimum On-time at 230 VAC	$C_{GATE} = 1\text{ nF}$	$t_{ON-MIN-230VAC}$	180	215	250	ns
Minimum On-time at 115 VAC	$C_{GATE} = 1\text{ nF}$	$t_{ON-MIN-115VAC}$	570	660	750	ns
Minimum On-time at 90 VAC	$C_{GATE} = 1\text{ nF}$	$t_{ON-MIN-90VAC}$	630	815	1000	ns
CURRENT FEEDBACK SECTION						
Reference Voltage of Constant Current Feedback		V_{CCR}	1.19	1.2	1.21	V
VCS Peak Value Amplifying Gain (Note 4)		A_{PK}	–	3.6	–	V/V
Attenuator Ratio of Constant Current Feedback Loop (Note 4)		A_{V-CC}	–	1/3.5	–	V/V
CURRENT SENSE SECTION						
Current Limit Threshold Voltage		V_{CS-LIM}	0.70	0.75	0.80	V
GATE Output Turn-Off Delay (Note 4)		t_{PD}	–	100	–	ns
Leading-Edge Blanking Time (Note 4)		t_{LEB}	150	200	250	ns
GATE SECTION						
Maximum On-Time		t_{ON-MAX}	15	17	20	μs
Gate Output Voltage Low		V_{GATE-L}	0	–	1.5	V
Internal Gate PMOS Driver ON		$V_{DD-PMOS-ON}$	7.0	7.5	8.0	V
Internal Gate PMOS Driver OFF		$V_{DD-PMOS-OFF}$	9.0	9.5	10.0	V
Gate Output Clamping Voltage	VDD level higher than 9 V	$V_{GATE-CLAMP}$	7.0	7.5	8.0	V
AUX SECTION						
CDC Compensation Voltage at Internal Reference	R_{CDC} is 330 k Ω	$V_{VS-CDC4}$	0.298	0.320	0.343	V
	R_{CDC} is 560 k Ω	$V_{VS-CDC3}$	0.223	0.240	0.257	V
	R_{CDC} is 920 k Ω	$V_{VS-CDC2}$	0.149	0.160	0.171	V
	R_{CDC} is 1.3 M Ω	$V_{VS-CDC1}$	0.074	0.080	0.086	V

Product parametric performance is indicated in the Electrical Characteristics for the listed test conditions, unless otherwise noted. Product performance may not be indicated by the Electrical Characteristics if operated under different conditions.

4. Guaranteed by Design.
5. T_A guaranteed range at 25°C

FAN105AM6X

TYPICAL PERFORMANCE CHARACTERISTICS

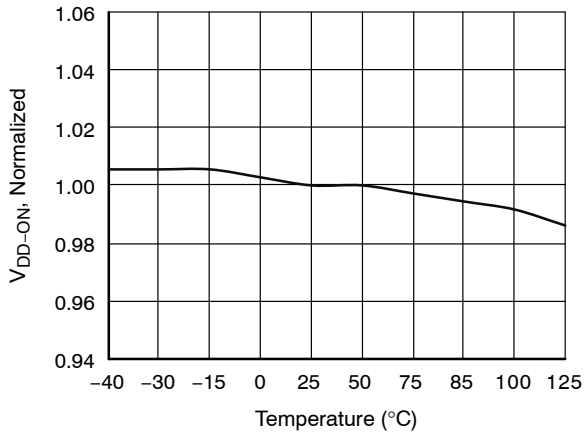

Figure 3. Turn-On Threshold Voltage (V_{DD-ON}) vs. Temperature

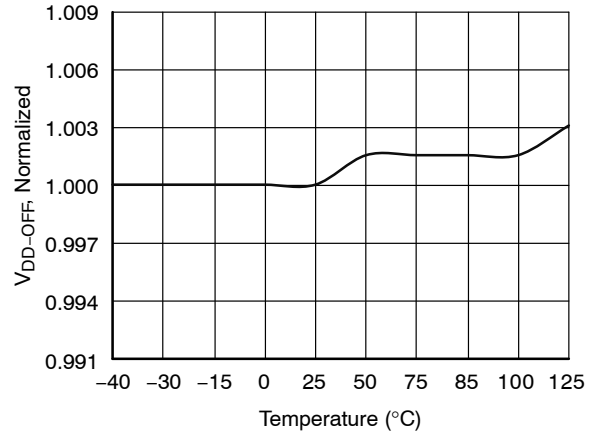

Figure 4. Turn-Off Threshold Voltage (V_{DD-OFF}) vs. Temperature

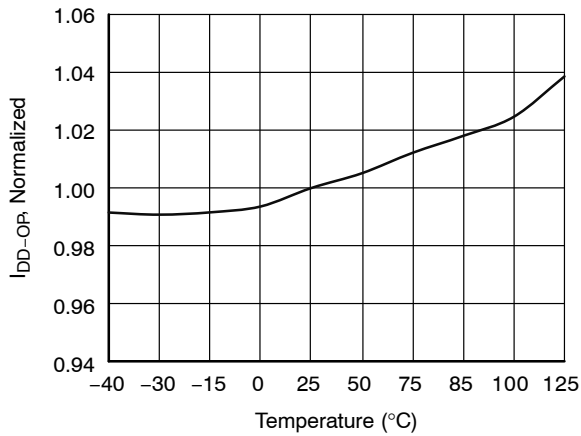

Figure 5. Operating Supply Current (I_{DD-OP}) vs. Temperature

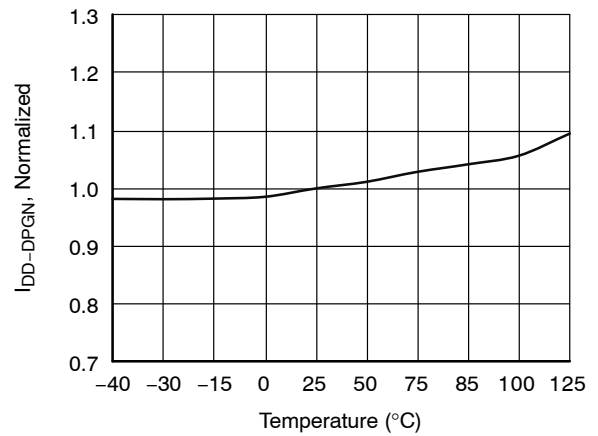

Figure 6. Deep Green Mode Operation Current ($I_{DD-DPGN}$) vs. Temperature

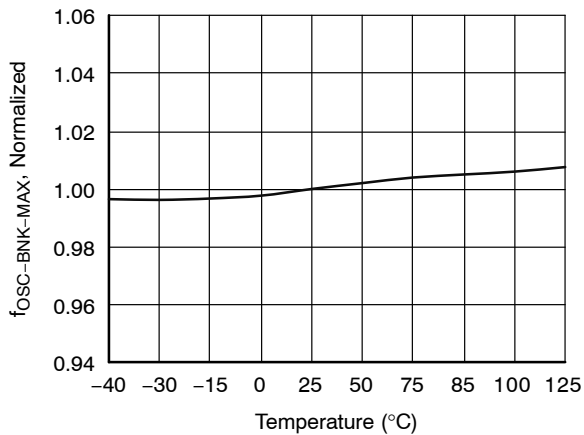

Figure 7. Maximum Operation Frequency of QR Blanking Time ($f_{OSC-BNK-MAX}$) vs. Temperature

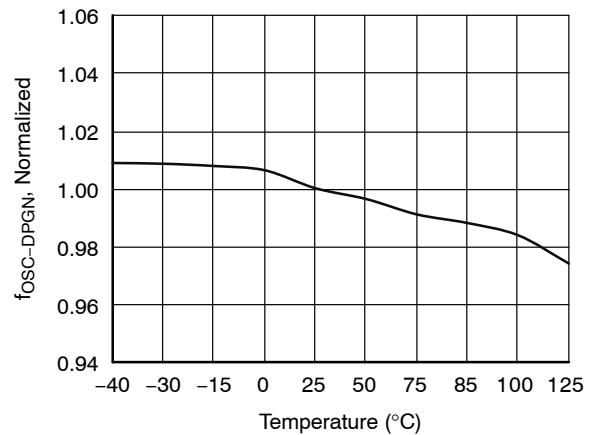

Figure 8. Deep Green Mode Operation Frequency ($f_{OSC-DPGN}$) vs. Temperature

FAN105AM6X

TYPICAL PERFORMANCE CHARACTERISTICS (continued)

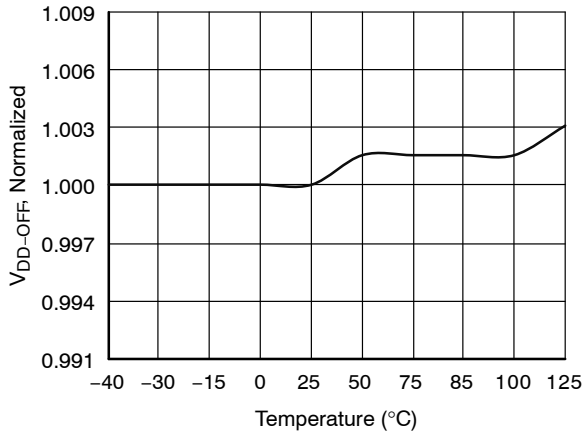

Figure 9. Reference Voltage of CV Feedback (V_{VR}) vs. Temperature

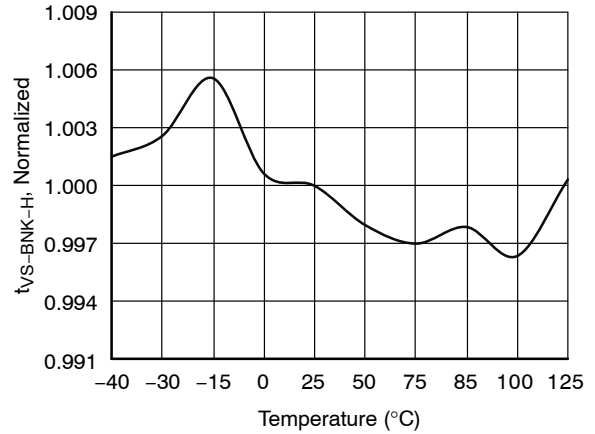

Figure 10. Vs Sampling Blanking Time ($t_{VS-BNK-H}$) vs. Temperature

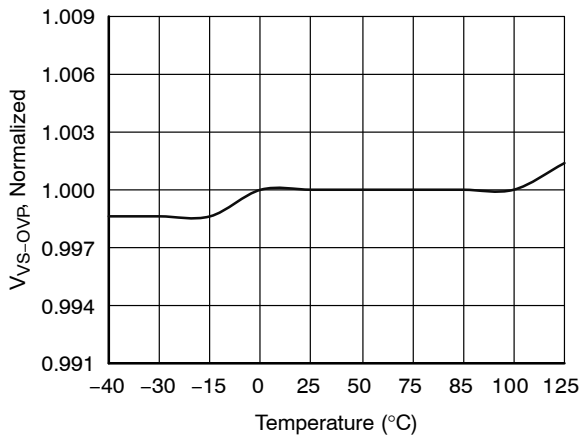

Figure 11. Output Over-Voltage Protection of Vs Sampling Threshold (V_{VS-OVP}) vs. Temperature

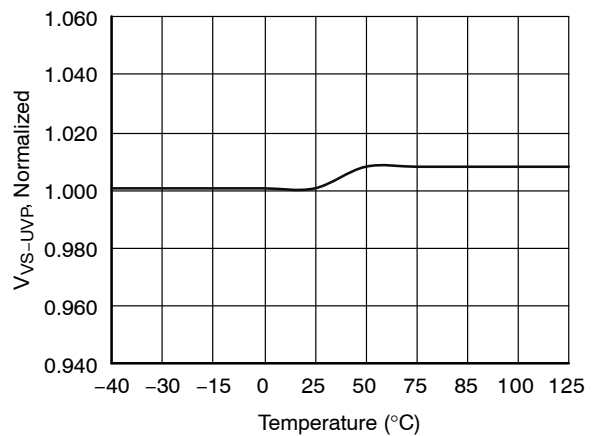

Figure 12. Output Under-Voltage of Vs Sampling Threshold (V_{VS-UVP}) vs. Temperature

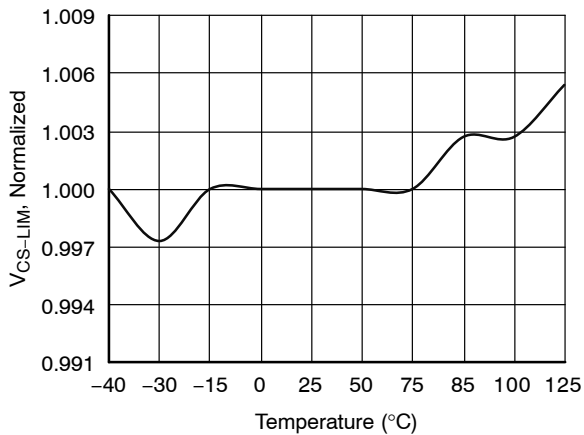

Figure 13. Current Limit Threshold Voltage (V_{CS-LIM}) vs. Temperature

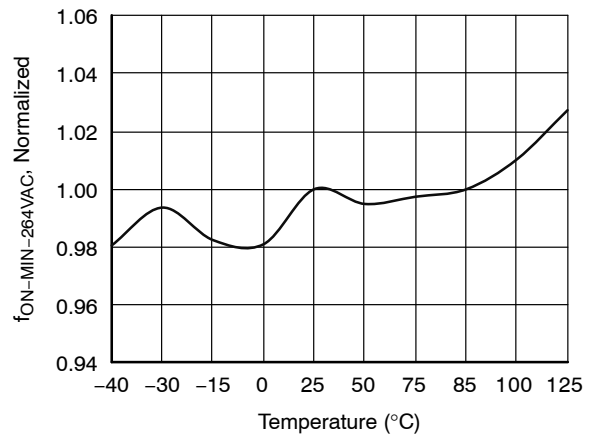

Figure 14. Minimum Gate Turn On Time ($t_{ON-MIN-264VAC}$) vs. Temperature

FAN105AM6X

TYPICAL PERFORMANCE CHARACTERISTICS (continued)

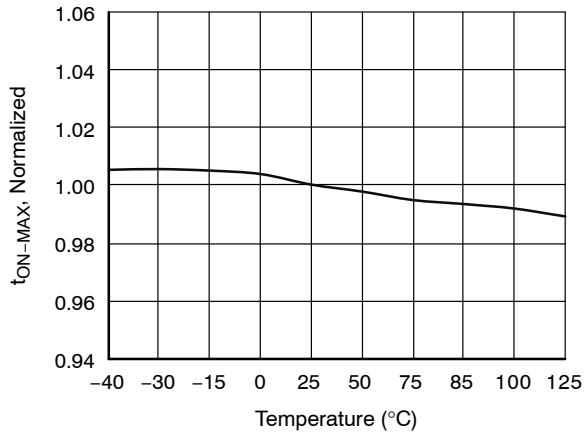

Figure 15. Maximum Gate Turn On Time (t_{ON-MAX}) vs. Temperature

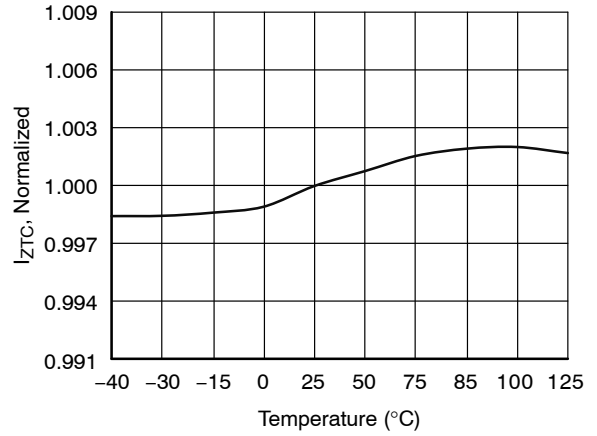

Figure 16. Dynamic Trigger Current Threshold (I_{ZTC}) vs. Temperature

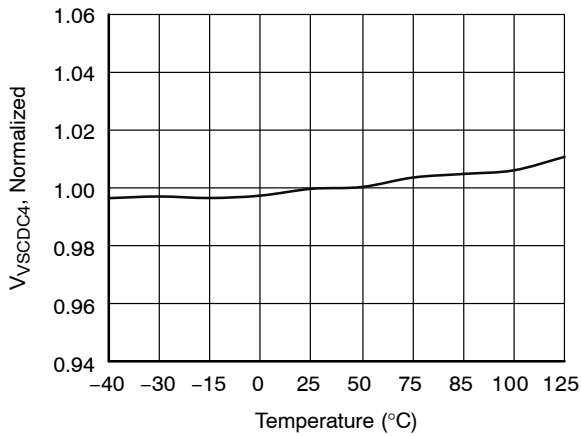

Figure 17. Cable Compensation Level 4 Reference Voltage ($V_{VS-CDC4}$) vs. Temperature

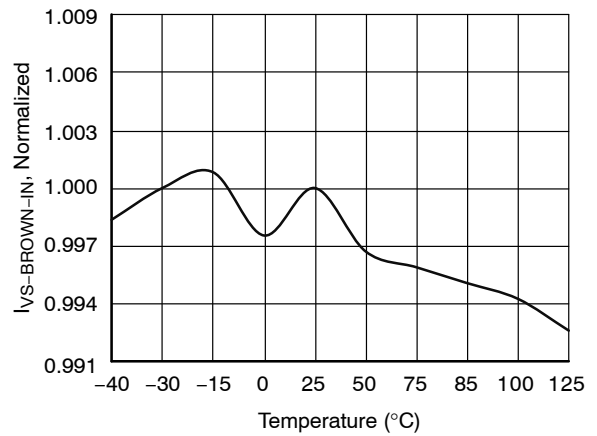

Figure 18. Brown In Threshold Current ($I_{VS-BROWN-IN}$) vs. Temperature

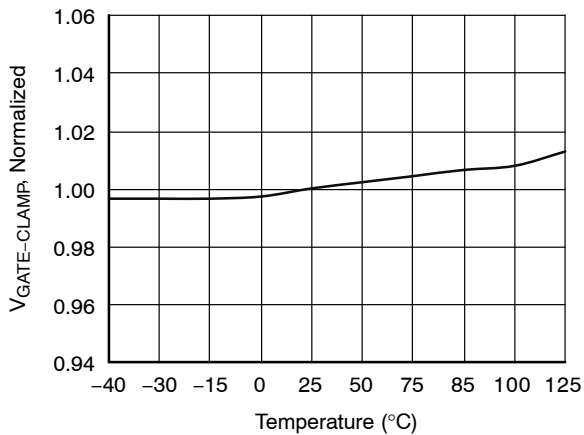

Figure 19. Clamp Voltage ($V_{GATE-CLAMP}$) vs. Temperature

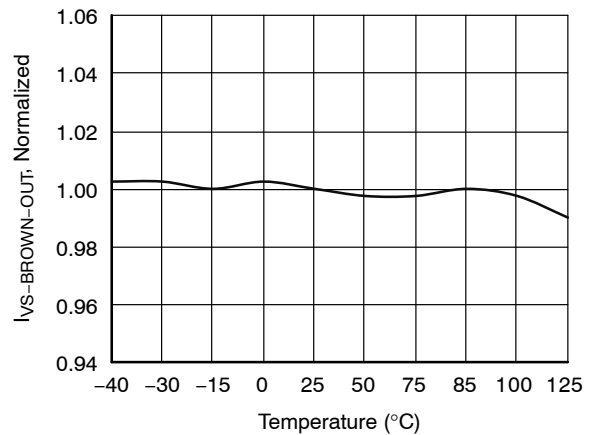

Figure 20. Brown Out Threshold Current ($I_{VS-BROWN-OUT}$) vs. Temperature

FAN105AM6X

TYPICAL PERFORMANCE CHARACTERISTICS (continued)

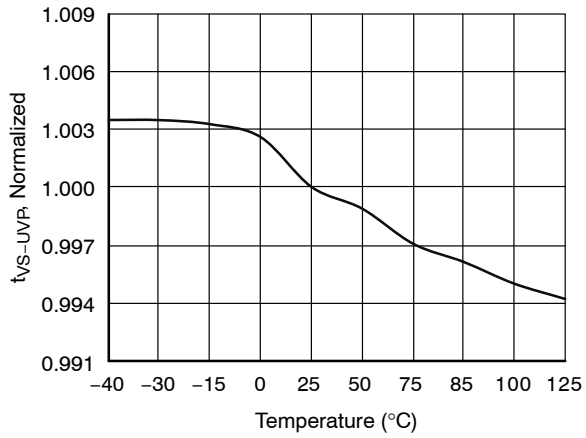

Figure 21. Blanking Time of VSUVP (t_{VS-UVP}) vs. Temperature

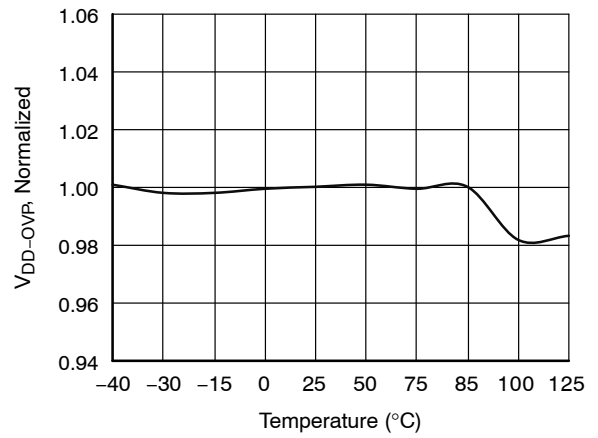

Figure 22. VDD Over Voltage Protection Threshold (V_{DD-OVP}) vs. Temperature

FUNCTIONAL DESCRIPTION

FAN105A is an offline PWM and Primary-Side Regulated (PSR) fly-back controller that can simplify feedback circuit and secondary side circuit compare to traditional fly-back converter. In addition, FAN105A detects Quasi-Resonant valley switching to minimize the switching loss and get better EMI performance.

FAN105A modulates pulse width and switching frequency based on feedback signal auxiliary winding signal (VS) and current sense signal (CS). Extremely accurately Constant Voltage (CV) with Cable Drop Compensation (CDC) and Constant Current (CC) could meet strict requirement from market. The CV and CC output characteristic is shown as Figure 23. There are 4 levels (80 mV – 320 mV) choices in CDC compensation weighting that is easily set via external SMD resistor.

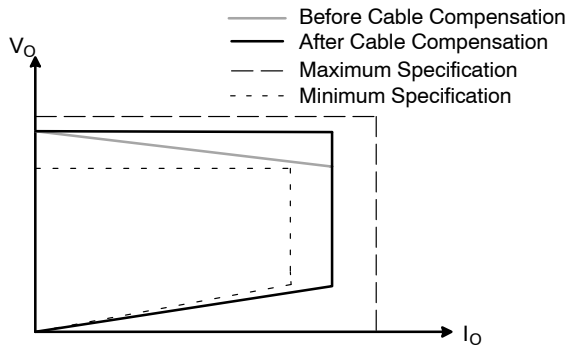

Figure 23. CV with CDC and CC V/I Curve at the Cable End

FAN105A implements Deep Green mode (DPGN) with lowest switching frequency, limits IC current consumption (450 μA) for excellent system standby power performance. Furthermore, the system design allows two kinds of startup circuit with resistor or high voltage FET.

Protections are: over/under voltage protection (VSOVP, VSUVP), Brown In and Brown Out, cycle by cycle over current protection (OCP), current sense resistor short protection, secondary rectifier short protection.

Basic CV/CC Control Principle

Figure 24 shows the circuit diagram of a PSR fly-back converter, FAN105A estimates output current through primary side peak current from CS, output voltage via auxiliary winding signal that proportional to secondary side voltage, the current and voltage sampling are shown in Figure 25. Generally, Discontinuous Conduction Mode (DCM) with valley switching operation is preferred for PSR since it allows better output regulation. The operation principles of DCM/BCM flyback converter are as follows:

During the MOSFET turn on time (t_{ON}), input voltage (V_{DL}) is applied across the primary-side inductor (L_m). Then MOSFET current (I_{DS}) increases linearly from zero to

the peak value (I_{pk}). Meanwhile, the energy is drawn from the input and stored in the inductor.

When the MOSFET is turned off, the energy stored in the inductor forces the secondary diode (D_{sec}) to turn on. While the diode is conducting, the output voltage (V_o), together with diode forward voltage drop (V_F), are applied across the secondary-side inductor (L_m x N_s² / N_p²) and the diode current (I_D) decreases linearly from the peak value (I_{pk} x N_p / N_s) to zero. At the end of inductor current discharge time (t_{DIS}), all the energy stored in the inductor has been delivered to the output.

When the diode current reaches zero, the transformer auxiliary winding voltage (V_{Aux}) begins to oscillate by the resonance between the primary-side inductor (L_m) and the effective capacitor loaded across MOSFET.

During the inductor current discharge time, the sum of output voltage and diode forward-voltage drop is reflected to the auxiliary winding side as (V_o + V_F) x N_{aux} / N_s. Since the diode forward-voltage drop decreases as current decreases, the auxiliary winding voltage reflects the output voltage best at the end of diode conduction time, where the diode current diminishes to zero. By sampling the winding voltage at the end of the diode conduction time, the output voltage information can be obtained. The internal error amplifier for output voltage regulation (EAV) compares the sampled voltage with internal precise reference to generate error voltage (COMV), which determines the duty cycle of the MOSFET in CV Mode.

The output current is obtained by averaging the triangular output diode current area over a switching cycle as:

$$I_o = \langle I_D \rangle_{AVG} = \frac{1}{2} \cdot I_{PK} \cdot \frac{N_p}{N_s} \cdot \frac{T_{DIS}}{T_s} \tag{eq. 1}$$

The internal FAN105A circuits identify the peak value of the drain current with a peak detection circuit and calculate the output current using the inductor discharge time (t_{DIS}) and switching period (t_s). This output information (EAI) is compared with internal precise reference to generate error voltage (COMI), which determines the duty cycle of the MOSFET in CC Mode. With TRUECURRENT® technique, constant output current can be precisely controlled.

With a given current sensing resistor, the output current can be programmed as:

$$I_o = \frac{1}{6} \cdot \frac{N_p}{N_s} \cdot \frac{V_{CCR}}{R_{CS}} \tag{eq. 2}$$

Of the two error voltages, COMV and COMI, the smaller one determines the duty cycle. During Constant Voltage regulation, COMV determines the duty cycle while COMI is saturated to HIGH. During Constant Current regulation, COMI determines the duty cycle while COMV is saturated to HIGH.

Deep Green Mode (DPGN) Operation in CV Mode

FAN105A integrated MWSAVER technology that minimize current consumption and frequency at DPGN mode is fixed to minimum switching frequency ($f_{OSC-DPGN}$) and variable Pulse width based on VS sampling voltage (EAV). V_{VS} regulated boundary are between $V_{VS-EAV-H}$ and $V_{VS-EAV-L}$.

After exit DPGN, internal regulation reference voltage was changed to V_{VR} .

FAN105A DPGN entry and exit criteria showed as below:

- DPGN entry need to meet both criteria as below:
 - ◆ Minimum frequency ($f_{OSC-MIN}$) operation continues over than $N_{DPGN-Entry}$ switching cycles.
 - ◆ $EAV > V_{VS-EAV-H}$ (2.550 V).
- DPGN exit criteria, meet one of below criteria:
 - ◆ $EAV < V_{VS-EAV-L}$ (2.525 V) and maximum on time at DPGN.
 - ◆ $EAV < V_{VS-EAV-DYN}$ (2.4 V).

During the DPGN mode controlling, FAN105A decreases the operating current down to 450 μA . Therefore, the standby power could meet international standard requirement when work with flexible start up circuit, designer have flexible start up circuit that HV FET or start up resistor depending on cost and better standby power consideration.

Cable Drop Compensation (CDC)

FAN105A integrates cable drop compensation function and the compensation weighting is calculated based on t_{DIS} , current sense voltage (V_{CS}), and CDC setting resistor (R_{CDC}) needed to between VDD and AUX pin. During startup, as VDD reached V_{DD-ON} , CDC programming block detects AUX pin current and determine cable drop compensation weighting based on current weighting of AUX pin. Once finished CDC compensation weighting detecting, the information will stored until shunt-down by protections or VDD lower than V_{DD-OFF} . The CDC weighting automatic detected input current during start up, which provides a constant output voltage at the end of the cable over the entire load range in CV Mode. The table shows the compensation weighting with corresponding R_{CDC} setting as below:

Table 1. CDC WEIGHTING AND R_{CDC} SETTING

R_{CDC}	Label	V_{VS} Compensation Weighting
1.3 M Ω	$V_{VS-CDC1}$	0.08 V
920 k Ω	$V_{VS-CDC2}$	0.16 V
560 k Ω	$V_{VS-CDC3}$	0.24 V
330 k Ω	$V_{VS-CDC4}$	0.32 V

TA designer can easily to set up CDC weighting via choose R_{CDC} following above table. In the table, resistance of R_{CDC} is recommended for corresponding compensation

level. Cable drop compensation voltage at output is proportional to V_{VS} compensation weighting that is internal reference voltage for CDC compensation.

Programmable Brown In/ Brown Out

FAN105A implement Brown out and Brown In through high side resistor setting at VS PIN. In actual system operation, VS PIN is drain a current (I_{VS}) that proportional to line voltage during MOSFET turns on. I_{VS} could predict by below equation:

$$I_{VS} = V_{DL} \cdot \frac{N_A}{N_P} \cdot \frac{1}{R_{VS1}} \tag{eq. 5}$$

Operating Current

The operating current in FAN105A is as small as 1.4 mA. The small operating current results in higher efficiency and reduces the V_{DD} hold-up capacitance requirement. During DPGN mode, the FAN105A consumption current is reduced to 450 μA , assisting the power supply meet standby power standard requirements.

Protections

The FAN105A self-protection includes V_{DD} Over-Voltage-Protection ($V_{DD} OVP$), Internal Chip Over-Temperature-Protection (OTP), VS Over-Voltage Protection (VSOVP), VS Under-Voltage Protection (VSUVP), CS pin Protection (CSP), Brownout and Brown In protection, and all of protection are implemented as Auto Restart (AR) mode.

When an Auto-Restart Mode protection is triggered, switching is terminated and the MOSFET remains off, causing V_{DD} to drop till V_{DD-OFF} and shut-down the system then all protections are reset. After then V_{DD} will be charged again by the input AC voltage and once touch V_{DD-ON} then switching resumes. This is the reason why it is called Auto-Restart, resumes switching automatically.

V_{DD} Over-Voltage-Protection ($V_{DD} OVP$)

When V_{DD} is raised up to higher level by some reasons, transformer V_{DD} winding turns are too many, load regulation is not good between transformer winding, VS information is not available anyhow and so on, and touches V_{DD-OVB} then FAN105A stops switching and protects IC from higher V_{DD} voltage. This is different then output voltage is over than pre determined level.

VS Under-Voltage Protection (VSUVP)

FAN105A build-in VSUVP function that prevent TA keep deliver power to phone side when output voltage is under the set voltage at VS pin. VSUVP has a 40 ms de-bounce time and once VDD touches V_{DD-ON} , during the later 40 ms VSUVP is disabled because VSUVP should not be triggered during the start up. VSUVP level can be calculated as below:

$$V_{O-UVP} = V_{VS-UVP} \cdot \left(1 + \frac{R_{VS1}}{R_{VS2}} \right) \cdot \frac{N_S}{N_A} \tag{eq. 6}$$

FAN105AM6X

VS Over-Voltage Protection (VSOVP)

The VSOVP is designed to prevent TA output voltage is over then the rating of used components, like capacitor. VSOVP has 4 switching cycles of denounce time and that prevent mis-triggered of VSOVP by switching noise. The protection level is changed in proportional to the CDC weighting.

VSOVP trigger level can be illustrates as following formula:

$$V_{O-OVP} = \left(V_{VS-UVP} + V_{VS-CDC} \cdot \frac{I_O}{I_{O-CC}} \right) \cdot \left(1 + \frac{R_{VS1}}{R_{VS2}} \right) \cdot \frac{N_S}{N_A} \quad (\text{eq. 7})$$

CS Pin Protection (CSP)

In order to prevent MOSFET current over than safe operating area, FAN105A build-in cycle by cycle over current protection. The protection could protect MOSFET damaged by saturation current and CS pin sensing error. As CS PIN signal meet below conditions FAN105A will turn off Gate immediately. Current Sensing Protection (CSP) criteria shows as below:

- $V_{CS} < 0.2 \text{ V}$ after switching turn on 4.5 μs at low line or 1.5 μs at high line.
- $V_{CS} > 1.5 \text{ V}$

Over-Temperature Protection (OTP)

In order to guarantee FAN105A works within recommended temperature. FAN105A build-in chip Over-Temperature-Protection (OTP). As chip junction temperature over threshold T_{OTP-H} IC immediately terminated Gate switching signal until chip junction temperature recover to T_{OTP-L} .

Start Up Function with AUX

FAN105A supports high voltage start up with HV FET that can make better standby power and shorter start up time. Figure 27 shows start up controlling function block. Figure 28 shows start up relative signal sequence with AUX controlling.

At system power on moment, initial VDD voltage is zero, internal PMOS switch is turn on and external high voltage FET also turn on, C_{VDD} is charged through HV FET till VDD reach V_{DD-ON} . While Internal PMOS switch S1 turn off and VGS of HV FET will close to internal clamping

voltage (V_{AUX-CL}) which less than HV FET VGS turn on threshold. Meanwhile VDD energy supplement is turn to auxiliary winding. The voltage gap between VDD and VAUX is keep at 5 V till controller shut-down by protection or VDD touching V_{DD-OFF} .

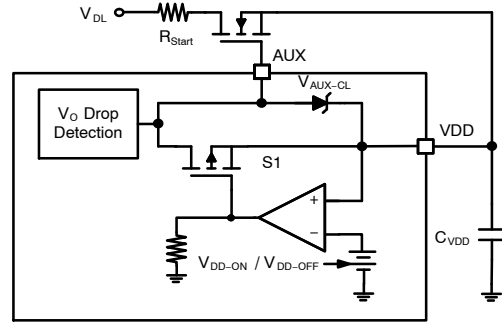

Figure 27. Internal Function for Start Up of AUX PIN

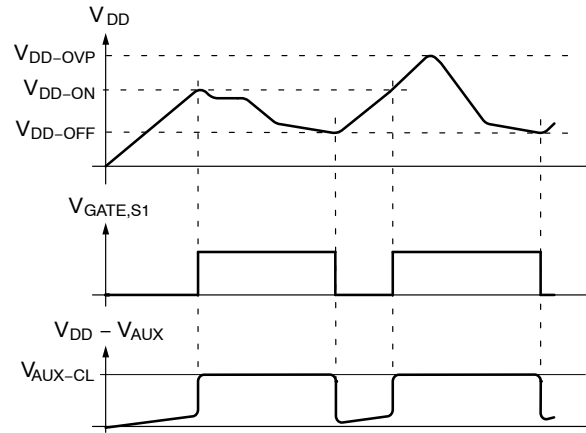

Figure 28. Start Up Sequence With AUX Controlling

Accurately Constant Current (CC) Compensation

FAN105A provides accurate constant current with universal line voltage range, In order to achieve this accurately output current regulated, FAN105A build in circuits that compensate a DC level at CS signal based on difference line voltage. It could avoid output current gap of difference line voltage during constand current controlling. For noise immunity, the recommendation of CS pin series resistor is 10 Ω .

ORDERING INFORMATION

Part Number	Operating Temperature Range	Package	Shipping [†]
FAN105AM6X	-40°C ~125°C	SOT-23, 6 Lead (Pb-Free)	3000 / Tape & Reel

[†]For information on tape and reel specifications, including part orientation and tape sizes, please refer to our Tape and Reel Packaging Specifications Brochure, BRD8011/D.

MECHANICAL CASE OUTLINE

PACKAGE DIMENSIONS

ON Semiconductor®



SOT-23, 6 Lead
CASE 527AJ
ISSUE B



SCALE 2:1

DATE 29 FEB 2012

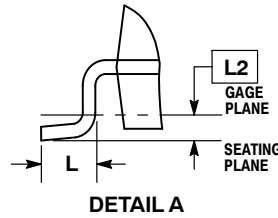
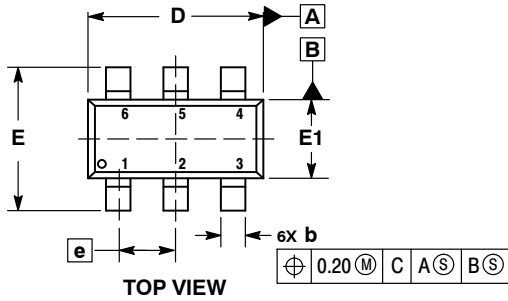

- NOTES:
1. DIMENSIONING AND TOLERANCING PER ASME Y14.5M, 1994.
 2. CONTROLLING DIMENSION: MILLIMETERS.
 3. DATUM C IS THE SEATING PLANE.

MILLIMETERS		
DIM	MIN	MAX
A	---	1.45
A1	0.00	0.15
A2	0.90	1.30
b	0.20	0.50
c	0.08	0.26
D	2.70	3.00
E	2.50	3.10
E1	1.30	1.80
e	0.95 BSC	
L	0.20	0.60
L2	0.25 BSC	

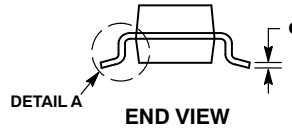
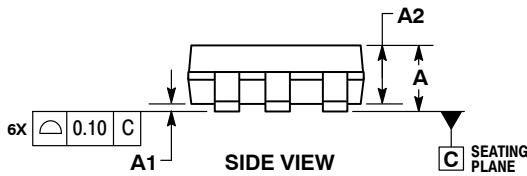

GENERIC MARKING DIAGRAM*

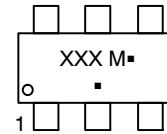

- XXX = Specific Device Code
- M = Date Code
- = Pb-Free Package

(Note: Microdot may be in either location)

*This information is generic. Please refer to device data sheet for actual part marking. Pb-Free indicator, "G" or microdot "▪", may or may not be present.

RECOMMENDED SOLDERING FOOTPRINT*

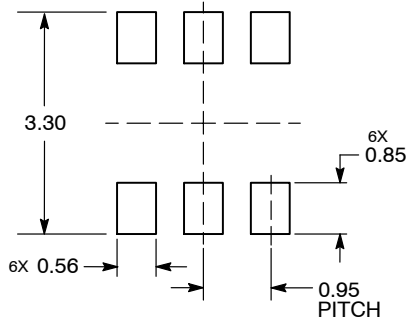

DIMENSIONS: MILLIMETERS

*For additional information on our Pb-Free strategy and soldering details, please download the ON Semiconductor Soldering and Mounting Techniques Reference Manual, SOLDERRM/D.

DOCUMENT NUMBER:	98AON34321E	Electronic versions are uncontrolled except when accessed directly from the Document Repository. Printed versions are uncontrolled except when stamped "CONTROLLED COPY" in red.
DESCRIPTION:	SOT-23, 6 LEAD	PAGE 1 OF 1

ON Semiconductor and are trademarks of Semiconductor Components Industries, LLC dba ON Semiconductor or its subsidiaries in the United States and/or other countries. ON Semiconductor reserves the right to make changes without further notice to any products herein. ON Semiconductor makes no warranty, representation or guarantee regarding the suitability of its products for any particular purpose, nor does ON Semiconductor assume any liability arising out of the application or use of any product or circuit, and specifically disclaims any and all liability, including without limitation special, consequential or incidental damages. ON Semiconductor does not convey any license under its patent rights nor the rights of others.

onsemi, **Onsemi**, and other names, marks, and brands are registered and/or common law trademarks of Semiconductor Components Industries, LLC dba "**onsemi**" or its affiliates and/or subsidiaries in the United States and/or other countries. **onsemi** owns the rights to a number of patents, trademarks, copyrights, trade secrets, and other intellectual property. A listing of **onsemi**'s product/patent coverage may be accessed at www.onsemi.com/site/pdf/Patent-Marking.pdf. **onsemi** reserves the right to make changes at any time to any products or information herein, without notice. The information herein is provided "as-is" and **onsemi** makes no warranty, representation or guarantee regarding the accuracy of the information, product features, availability, functionality, or suitability of its products for any particular purpose, nor does **onsemi** assume any liability arising out of the application or use of any product or circuit, and specifically disclaims any and all liability, including without limitation special, consequential or incidental damages. Buyer is responsible for its products and applications using **onsemi** products, including compliance with all laws, regulations and safety requirements or standards, regardless of any support or applications information provided by **onsemi**. "Typical" parameters which may be provided in **onsemi** data sheets and/or specifications can and do vary in different applications and actual performance may vary over time. All operating parameters, including "Typicals" must be validated for each customer application by customer's technical experts. **onsemi** does not convey any license under any of its intellectual property rights nor the rights of others. **onsemi** products are not designed, intended, or authorized for use as a critical component in life support systems or any FDA Class 3 medical devices or medical devices with a same or similar classification in a foreign jurisdiction or any devices intended for implantation in the human body. Should Buyer purchase or use **onsemi** products for any such unintended or unauthorized application, Buyer shall indemnify and hold **onsemi** and its officers, employees, subsidiaries, affiliates, and distributors harmless against all claims, costs, damages, and expenses, and reasonable attorney fees arising out of, directly or indirectly, any claim of personal injury or death associated with such unintended or unauthorized use, even if such claim alleges that **onsemi** was negligent regarding the design or manufacture of the part. **onsemi** is an Equal Opportunity/Affirmative Action Employer. This literature is subject to all applicable copyright laws and is not for resale in any manner.

PUBLICATION ORDERING INFORMATION

LITERATURE FULFILLMENT:

Email Requests to: orderlit@onsemi.com

onsemi Website: www.onsemi.com

TECHNICAL SUPPORT

North American Technical Support:

Voice Mail: 1 800-282-9855 Toll Free USA/Canada

Phone: 011 421 33 790 2910

Europe, Middle East and Africa Technical Support:

Phone: 00421 33 790 2910

For additional information, please contact your local Sales Representative

Mouser Electronics

Authorized Distributor

Click to View Pricing, Inventory, Delivery & Lifecycle Information:

[onsemi:](#)

[FAN105AM6X](#)