

Single/Dual/Quad, 270MHz, 1mA, SOT23, Current-Feedback Amplifiers with Shutdown

ABSOLUTE MAXIMUM RATINGS

| | | | |
|---|--|---|-----------------|
| Supply Voltage (V _{CC} to V _{EE}) | 12V | 8-Pin SO (derate 5.88mW/°C above +70°C)..... | 471mW |
| Analog Input Voltage | (V _{EE} - 0.3V) to (V _{CC} + 0.3V) | 10-Pin μ MAX (derate 5.60mW/°C above +70°C) | 444mW |
| Differential Input Voltage | $\pm 2V$ | 14-Pin SO (derate 8.33mW/°C above +70°C)..... | 667mW |
| $\overline{\text{SHDN}}$ Input Voltage | (V _{EE} - 0.3V) to (V _{CC} + 0.3V) | 16-Pin QSOP (derate 8.30mW/°C above +70°C)..... | 667mW |
| Short-Circuit Duration (OUT to GND, V _{CC} or V _{EE})..... | Continuous | Operating Temperature Range | -40°C to +85°C |
| Continuous Power Dissipation (T _A = +70°C) | | Storage Temperature Range | -65°C to +150°C |
| 6-Pin SOT23 (derate 7.10mW/°C above +70°C)..... | 571mW | Lead Temperature (soldering, 10s) | +300°C |

Stresses beyond those listed under "Absolute Maximum Ratings" may cause permanent damage to the device. These are stress ratings only, and functional operation of the device at these or any other conditions beyond those indicated in the operational sections of the specifications is not implied. Exposure to absolute maximum rating conditions for extended periods may affect device reliability.

DC ELECTRICAL CHARACTERISTICS—Dual Supplies

(V_{CC} = +5V, V_{EE} = -5V, V_{IN+} = 0, $\overline{\text{SHDN}} \geq 3V$; T_A = T_{MIN} to T_{MAX}, unless otherwise noted. Typical values are at T_A = +25°C.) (Note 1)

| PARAMETER | SYMBOL | CONDITIONS | MIN | TYP | MAX | UNITS |
|---|-----------------------|--|-----------------------|-----------|-----------------------|------------------------------|
| Input Voltage Range | V _{CM} | Guaranteed by CMRR test | ± 3.6 | ± 3.9 | | V |
| Input Offset Voltage | V _{OS} | V _{CM} = 0 | | ± 1.5 | ± 7 | mV |
| Input Offset-Voltage Drift | TC _{VOS} | | | ± 12 | | $\mu\text{V}/^\circ\text{C}$ |
| Input Offset-Voltage Matching | | MAX4182-MAX4187 | | ± 1 | | mV |
| Input Bias Current (Positive Input) | I _{B+} | | | ± 1 | ± 7 | μA |
| Input Bias Current (Negative Input) | I _{B-} | | | ± 1 | ± 12 | μA |
| Input Resistance (Positive Input) | R _{IN+} | $-3.6V \leq V_{IN+} \leq 3.6V$, $-1V \leq (V_{IN+} - V_{IN-}) \leq 1V$ | 250 | 800 | | k Ω |
| Input Resistance (Negative Input) | R _{IN-} | | | 160 | | Ω |
| Common-Mode Rejection Ratio | CMRR | $-3.6V \leq V_{CM} \leq 3.6V$ | -50 | -58 | | dB |
| Open-Loop Transresistance | T _R | R _L = 1k Ω , V _{OUT} = $\pm 3.6V$ | 0.8 | 3.0 | | M Ω |
| | | R _L = 150 Ω , V _{OUT} = $\pm 2.5V$ | 0.3 | 0.9 | | |
| Output Voltage Swing | V _{SW} | R _L = 1k Ω | ± 3.75 | ± 4.0 | | V |
| | | R _L = 150 Ω | ± 3.0 | ± 3.3 | | |
| | | R _L = 100 Ω | | ± 3.0 | | |
| Output Current | I _{OUT} | R _L = 30 Ω | ± 32 | ± 60 | | mA |
| Output Short-Circuit Current | I _{SC} | | | ± 80 | | mA |
| Output Resistance | R _{OUT} | | | 0.2 | | Ω |
| Disabled Output Leakage Current | I _{OUT(OFF)} | $\overline{\text{SHDN}} \leq V_{IL}$, V _{OUT} $\leq \pm 3V$ (Notes 2, 4) | | ± 0.1 | ± 6.0 | μA |
| $\overline{\text{SHDN}}$ Logic Low Threshold | V _{IL} | (Notes 3, 4) | | | V _{CC} - 3.0 | V |
| $\overline{\text{SHDN}}$ Logic High Threshold | V _{IH} | (Notes 3, 4) | V _{CC} - 2.0 | | | V |

Single/Dual/Quad, 270MHz, 1mA, SOT23, Current-Feedback Amplifiers with Shutdown

MAX4180-MAX4187

DC ELECTRICAL CHARACTERISTICS—Dual Supplies (continued)

($V_{CC} = +5V$, $V_{EE} = -5V$, $V_{IN+} = 0$, $\overline{SHDN} \geq 3V$; $T_A = T_{MIN}$ to T_{MAX} , unless otherwise noted. Typical values are at $T_A = +25^\circ C$.) (Note 1)

| PARAMETER | SYMBOL | CONDITIONS | | MIN | TYP | MAX | UNITS |
|--|-----------------|--|--------------------|-------|------|-------|-------|
| \overline{SHDN} Logic Input Bias Current | I_{IN} | $V_{EE} \leq \overline{SHDN} \leq V_{CC}$ (Note 4) | | | ±0.1 | ±2.0 | μA |
| Positive Power-Supply Rejection Ratio | PSRR+ | $V_{EE} = -5V$, $V_{CC} = 4.5V$ to $5.5V$ | | 60 | 71 | | dB |
| Negative Power-Supply Rejection Ratio | PSRR- | $V_{CC} = 5V$, $V_{EE} = -4.5V$ to $-5.5V$ | | 53 | 62 | | dB |
| Operating Supply Voltage | V_{CC}/V_{EE} | | | ±2.25 | | ±5.50 | V |
| Quiescent Supply Current per Amplifier | I_S | $R_L = \infty$ | MAX418_EUT | | 1.0 | 1.3 | mA |
| | | | All other packages | | 1.0 | 1.2 | |
| Shutdown Supply Current per Amplifier | $I_{S(OFF)}$ | $\overline{SHDN} = 0$, $R_L = \infty$ (Note 4) | | | 135 | 180 | μA |

DC ELECTRICAL CHARACTERISTICS—Single Supply

($V_{CC} = +5V$, $V_{EE} = 0$, $V_{IN+} = 2.5V$, $\overline{SHDN} \geq 3V$, R_L to $V_{CC}/2$; $T_A = T_{MIN}$ to T_{MAX} , unless otherwise noted. Typical values are at $T_A = +25^\circ C$.) (Note 1)

| PARAMETER | SYMBOL | CONDITIONS | MIN | TYP | MAX | UNITS |
|-------------------------------------|------------|--|--------------|------------|-----|-------|
| Input Voltage Range | V_{CM} | | 1.3 to 3.7 | 1.1 to 3.9 | | V |
| Input Offset Voltage | V_{OS} | $V_{CM} = 2.5V$ | | ±1.5 | ±7 | mV |
| Input Offset Voltage Drift | TC_{VOS} | | | ±12 | | μV/°C |
| Input Offset Voltage Matching | | MAX4182-MAX4187 | | ±1 | | mV |
| Input Bias Current (Positive Input) | I_{B+} | | | ±1 | ±7 | μA |
| Input Bias Current (Negative Input) | I_{B-} | | | ±1 | ±12 | μA |
| Input Resistance (Positive Input) | R_{IN+} | $1.3V \leq V_{IN+} \leq 3.7V$, $-1V \leq (V_{IN+} - V_{IN-}) \leq 1V$ | 250 | 800 | | kΩ |
| Input Resistance (Negative Input) | R_{IN-} | | | 160 | | Ω |
| Common-Mode Rejection Ratio | CMRR | $1.3V \leq V_{CM} \leq 3.7V$ | -50 | -58 | | dB |
| Open-Loop Transresistance | T_R | $R_L = 1k\Omega$, $V_{OUT} = 1.2V$ to $3.8V$ | 0.8 | 2.5 | | MΩ |
| | | $R_L = 150\Omega$, $V_{OUT} = 1.4V$ to $3.6V$ | 0.275 | 0.9 | | |
| Output Voltage Swing | V_{SW} | $R_L = 1k\Omega$ | 1.15 to 3.85 | 1.0 to 4.0 | | V |
| | | $R_L = 150\Omega$ | 1.35 to 3.65 | 1.2 to 3.8 | | |
| | | $R_L = 100\Omega$ | | 1.3 to 3.7 | | |

Single/Dual/Quad, 270MHz, 1mA, SOT23, Current-Feedback Amplifiers with Shutdown

DC ELECTRICAL CHARACTERISTICS—Single Supply (continued)

($V_{CC} = +5V$, $V_{EE} = 0$, $V_{IN+} = 2.5V$, $\overline{SHDN} \geq 3V$, R_L to $V_{CC}/2$; $T_A = T_{MIN}$ to T_{MAX} , unless otherwise noted. Typical values are at $T_A = +25^\circ C$.) (Note 1)

| PARAMETER | SYMBOL | CONDITIONS | | MIN | TYP | MAX | UNITS |
|--|----------------|---|--------------------|----------|-----------|----------------|----------|
| Output Current | I_{OUT} | $R_L = 30\Omega$ | | ± 18 | ± 30 | | mA |
| Output Short-Circuit Current | I_{SC} | | | | ± 50 | | mA |
| Output Resistance | R_{OUT} | | | | 0.2 | | Ω |
| Disabled Output Leakage Current | $I_{OUT(OFF)}$ | $\overline{SHDN} \leq V_{IL}$, $1.2V \leq V_{OUT} \leq 3.8V$ (Notes 2, 4) | | | ± 0.1 | ± 4.0 | μA |
| \overline{SHDN} Logic-Low Threshold | V_{IL} | (Notes 3, 4) | | | | $V_{CC} - 3.0$ | V |
| \overline{SHDN} Logic-High Threshold | V_{IH} | (Notes 3, 4) | | | | $V_{CC} - 2.0$ | V |
| \overline{SHDN} Logic Input Bias Current | I_{IN} | $0 \leq \overline{SHDN} \leq V_{CC}$ (Note 4) | | | ± 0.1 | ± 2.0 | μA |
| Power-Supply Rejection Ratio | PSRR | $V_{CC} = 4.5V$ to $5.5V$ | | 60 | 71 | | dB |
| Operating Supply Voltage | V_{CC} | | | 4.5 | | 5.5 | V |
| Quiescent Supply Current per Amplifier | I_S | $R_L = \infty$ | MAX418_EUT | | 1.0 | 1.25 | mA |
| | | | All other packages | | 1.0 | 1.2 | |
| Shutdown Supply Current per Amplifier | $I_{S(OFF)}$ | $\overline{SHDN} = 0$, $R_L = \infty$ (Note 4) | | | 135 | 180 | μA |

AC ELECTRICAL CHARACTERISTICS—Dual Supplies (MAX4180/4182/4183/4186)

($V_{CC} = +5V$, $V_{EE} = -5V$, $V_{IN} = 0$, $\overline{SHDN} \geq 3V$, $A_V = +2V/V$; see Table 1 for R_F and R_G values; $T_A = +25^\circ C$, unless otherwise noted.)

| PARAMETER | SYMBOL | CONDITIONS | | MIN | TYP | MAX | UNITS |
|---------------------------------------|---------------|---|-------------------|-----|-----|-----|------------|
| Small-Signal -3dB Bandwidth (Note 5) | BW_{SS} | <0.5dB peaking | $R_L = 1k\Omega$ | 180 | 245 | | MHz |
| | | | $R_L = 150\Omega$ | | 190 | | |
| Large-Signal -3dB Bandwidth | BW_{LS} | $V_{OUT} = 2V_{p-p}$, $R_L = 1k\Omega$ | | | 150 | | MHz |
| Bandwidth for 0.1dB Flatness (Note 5) | $BW_{0.1dB}$ | $R_L = 1k\Omega$ | | 30 | 70 | | MHz |
| | | $R_L = 150\Omega$ | | | 70 | | |
| Slew Rate (Note 5) | SR | $V_{OUT} = 2V$ step, $R_L = 1k\Omega$ | Rising edge | 340 | 450 | | V/ μs |
| | | | Falling edge | 315 | 420 | | |
| Settling Time to 0.1% | t_s | $V_{OUT} = 2V$ step, $R_L = 1k\Omega$ | | | 20 | | ns |
| Rise/Fall Time | t_R , t_F | $V_{OUT} = 2V$ step, $R_L = 1k\Omega$ | | | 5 | | ns |
| Spurious-Free Dynamic Range | SFDR | $f_C = 5MHz$, $V_{OUT} = 2V_{p-p}$ | $R_L = 1k\Omega$ | | 73 | | dBc |
| | | | $R_L = 150\Omega$ | | 57 | | |
| Second Harmonic Distortion | | $f_C = 5MHz$, $V_{OUT} = 2V_{p-p}$ | $R_L = 1k\Omega$ | | -83 | | dBc |
| | | | $R_L = 150\Omega$ | | -68 | | |
| Third Harmonic Distortion | | $f_C = 5MHz$, $V_{OUT} = 2V_{p-p}$ | $R_L = 1k\Omega$ | | -73 | | dBc |
| | | | $R_L = 150\Omega$ | | -57 | | |

Single/Dual/Quad, 270MHz, 1mA, SOT23, Current-Feedback Amplifiers with Shutdown

MAX4180-MAX4187

AC ELECTRICAL CHARACTERISTICS—Dual Supplies (MAX4180/4182/4183/4186) (cont.)

($V_{CC} = +5V$, $V_{EE} = -5V$, $V_{IN} = 0$, $\overline{SHDN} \geq 3V$, $A_V = +2V/V$; see Table 1 for R_F and R_G values; $T_A = +25^\circ C$, unless otherwise noted.)

| PARAMETER | SYMBOL | CONDITIONS | | MIN | TYP | MAX | UNITS |
|-------------------------------------|----------------|--|-------------------|-----|------|-----|----------------|
| Differential Phase Error | DP | NTSC | $R_L = 1k\Omega$ | | 0.03 | | degrees |
| | | | $R_L = 150\Omega$ | | 0.30 | | |
| Differential Gain Error | DG | NTSC | $R_L = 1k\Omega$ | | 0.08 | | % |
| | | | $R_L = 150\Omega$ | | 0.01 | | |
| Input Noise-Voltage Density | e_n | $f = 10kHz$ | | | 2 | | nV/\sqrt{Hz} |
| Input Noise-Current Density | i_n | $f = 10kHz$ | IN+ | | 4 | | pA/\sqrt{Hz} |
| | | | IN- | | 5 | | |
| Input Capacitance (Positive Input) | C_{IN+} | | | | 1.5 | | pF |
| Output Impedance | Z_{OUT} | $f = 10kHz$ | | | 4.8 | | Ω |
| Disabled Output Capacitance | $C_{OUT(OFF)}$ | $\overline{SHDN} \leq V_{IL}$, $V_{OUT} \leq \pm 3V$ (Notes 2, 4) | | | 4 | | pF |
| Turn-On Time from \overline{SHDN} | t_{ON} | (Note 4) | | | 40 | | ns |
| Turn-Off Time to \overline{SHDN} | t_{OFF} | (Note 4) | | | 400 | | ns |
| Power-Up Time | | | | | 200 | | μs |
| Off-Isolation | | $\overline{SHDN} \leq 2V$, $R_L = 150\Omega$, $f = 10MHz$ | | | -60 | | dB |
| Crosstalk | | $f = 10MHz$, MAX4182/4183/4186 | | | -60 | | dB |
| Gain Matching to 0.1dB | | $f = 10MHz$, MAX4182/4183/4186 | | | 25 | | MHz |

AC ELECTRICAL CHARACTERISTICS—Dual Supplies (MAX4181/4184/4185/4187)

($V_{CC} = +5V$, $V_{EE} = -5V$, $V_{IN+} = 0$, $\overline{SHDN} \geq 3V$, $A_V = +1V/V$; see Table 1 for R_F values; $T_A = +25^\circ C$, unless otherwise noted.)

| PARAMETER | SYMBOL | CONDITIONS | | MIN | TYP | MAX | UNITS |
|---------------------------------------|-----------------|---|-------------------|-----|------|-----|-----------|
| Small-Signal -3dB Bandwidth (Note 5) | BW_{SS} | <0.5dB peaking | $R_L = 1k\Omega$ | 195 | 270 | | MHz |
| | | | $R_L = 150\Omega$ | | 205 | | |
| Large-Signal -3dB Bandwidth | BW_{LS} | $V_{OUT} = 2V_{p-p}$, $R_L = 1k\Omega$ | | | 90 | | MHz |
| Bandwidth for 0.1dB Flatness (Note 5) | $BW_{0.1dB}$ | $R_L = 1k\Omega$ | | 20 | 60 | | MHz |
| | | $R_L = 150\Omega$ | | | 55 | | |
| Slew Rate (Note 5) | SR | $V_{OUT} = 2V$ step, $R_L = 1k\Omega$ | Rising edge | 250 | 320 | | $V/\mu s$ |
| | | | Falling edge | 200 | 265 | | |
| Settling Time to 0.1% | t_s | $V_{OUT} = 2V$ step, $R_L = 1k\Omega$ | | | 21 | | ns |
| Rise/Fall Time | t_R and t_F | $V_{OUT} = 2V$ step, $R_L = 1k\Omega$ | | | 5 | | ns |
| Spurious-Free Dynamic Range | SFDR | $f_C = 5MHz$, $V_{OUT} = 2V_{p-p}$ | $R_L = 1k\Omega$ | | 57 | | dB |
| | | | $R_L = 150\Omega$ | | 66 | | |
| Second Harmonic Distortion | | $f_C = 5MHz$, $V_{OUT} = 2V_{p-p}$ | $R_L = 1k\Omega$ | | -70 | | dB |
| | | | $R_L = 150\Omega$ | | -73 | | |
| Third Harmonic Distortion | | $f_C = 5MHz$, $V_{OUT} = 2V_{p-p}$ | $R_L = 1k\Omega$ | | -57 | | dB |
| | | | $R_L = 150\Omega$ | | -66 | | |
| Differential Phase Error | DP | NTSC | $R_L = 1k\Omega$ | | 0.01 | | degrees |
| | | | $R_L = 150\Omega$ | | 0.48 | | |

Single/Dual/Quad, 270MHz, 1mA, SOT23, Current-Feedback Amplifiers with Shutdown

AC ELECTRICAL CHARACTERISTICS—Dual Supplies (MAX4181/4184/4185/4187) (cont.)

($V_{CC} = +5V$, $V_{EE} = -5V$, $V_{IN+} = 0$, $\overline{SHDN} \geq 3V$, $A_V = +1V/V$; see Table 1 for R_F values; $T_A = +25^\circ C$, unless otherwise noted.)

| PARAMETER | SYMBOL | CONDITIONS | | MIN | TYP | MAX | UNITS |
|-------------------------------------|----------------|--|-------------------|-----|------|-----|----------------|
| Differential Gain Error | DG | NTSC | $R_L = 1k\Omega$ | | 0.09 | | % |
| | | | $R_L = 150\Omega$ | | 0.16 | | |
| Input Noise-Voltage Density | e_n | $f = 10kHz$ | | | 2 | | nV/\sqrt{Hz} |
| Input Noise-Current Density | i_n | $f = 10kHz$ | IN+ | | 4 | | pA/\sqrt{Hz} |
| | | | IN- | | 5 | | |
| Input Capacitance (Positive Input) | C_{IN+} | | | | 1.5 | | pF |
| Output Impedance | Z_{OUT} | $f = 10kHz$ | | | 4.8 | | Ω |
| Disabled Output Capacitance | $C_{OUT(OFF)}$ | $\overline{SHDN} \leq V_{IL}$, $V_{OUT} \leq \pm 3V$ (Notes 2, 4) | | | 4 | | pF |
| Turn-On Time from \overline{SHDN} | t_{ON} | (Note 4) | | | 50 | | ns |
| Turn-Off Time to \overline{SHDN} | t_{OFF} | (Note 4) | | | 400 | | ns |
| Power-Up Time | | | | | 200 | | μs |
| Off-Isolation | | $\overline{SHDN} \leq 2V$, $R_L = 150\Omega$, $f = 10MHz$ | | | -54 | | dB |
| Crosstalk | | $f = 10MHz$, MAX4184/MAX4185/MAX4187 | | | -60 | | dB |
| Gain Matching to 0.1dB | | $f = 10MHz$, MAX4184/MAX4185/MAX4187 | | | 25 | | MHz |

AC ELECTRICAL CHARACTERISTICS—Single Supply (MAX4180/4182/4183/4186)

($V_{CC} = +5V$, $V_{EE} = 0$, $V_{IN+} = 2.5V$, $\overline{SHDN} \geq 3V$, $A_V = +2V/V$; see Table 1 for R_F and R_G values; $T_A = +25^\circ C$, unless otherwise noted.)

| PARAMETER | SYMBOL | CONDITIONS | | MIN | TYP | MAX | UNITS |
|---------------------------------------|-----------------|---|-------------------|-----|------|-----|-----------|
| Small-Signal -3dB Bandwidth (Note 5) | BW_{SS} | <0.5dB peaking | $R_L = 1k\Omega$ | 155 | 210 | | MHz |
| | | | $R_L = 150\Omega$ | | 165 | | |
| Large-Signal -3dB Bandwidth | BW_{LS} | $V_{OUT} = 2V_{p-p}$, $R_L = 1k\Omega$ | | | 110 | | MHz |
| Bandwidth for 0.1dB Flatness (Note 5) | $BW_{0.1dB}$ | $R_L = 1k\Omega$ | | 20 | 50 | | MHz |
| | | $R_L = 150\Omega$ | | | 40 | | |
| Slew Rate (Note 5) | SR | $V_{OUT} = 2V$ step, $R_L = 1k\Omega$ | Rising edge | 260 | 340 | | $V/\mu s$ |
| | | | Falling edge | 220 | 300 | | |
| Settling Time to 0.1% | t_s | $V_{OUT} = 2V$ step, $R_L = 1k\Omega$ | | | 20 | | ns |
| Rise/Fall Time | t_R and t_F | $V_{OUT} = 2V$ step, $R_L = 1k\Omega$ | | | 6 | | ns |
| Spurious-Free Dynamic Range | SFDR | $f_C = 5MHz$, $V_{OUT} = 2V_{p-p}$ | $R_L = 1k\Omega$ | | 72 | | dB |
| | | | $R_L = 150\Omega$ | | 57 | | |
| Second Harmonic Distortion | | $f_C = 5MHz$, $V_{OUT} = 2V_{p-p}$ | $R_L = 1k\Omega$ | | -80 | | dBc |
| | | | $R_L = 150\Omega$ | | -76 | | |
| Third Harmonic Distortion | | $f_C = 5MHz$, $V_{OUT} = 2V_{p-p}$ | $R_L = 1k\Omega$ | | -72 | | dBc |
| | | | $R_L = 150\Omega$ | | -57 | | |
| Differential Phase Error | DP | NTSC | $R_L = 1k\Omega$ | | 0.01 | | degrees |
| | | | $R_L = 150\Omega$ | | 0.35 | | |

Single/Dual/Quad, 270MHz, 1mA, SOT23, Current-Feedback Amplifiers with Shutdown

MAX4180-MAX4187

AC ELECTRICAL CHARACTERISTICS—Single Supply (MAX4180/4182/4183/4186) (cont.)

($V_{CC} = +5V$, $V_{EE} = 0$, $V_{IN+} = 2.5V$, $\overline{SHDN} \geq 3V$, $A_v = +2V/V$; see Table 1 for R_F and R_G values; $T_A = +25^\circ C$, unless otherwise noted.)

| PARAMETER | SYMBOL | CONDITIONS | | MIN | TYP | MAX | UNITS |
|-------------------------------------|----------------|--|-------------------|-----|------|-----|-----------------|
| Differential Gain Error | DG | NTSC | $R_L = 1k\Omega$ | | 0.10 | | % |
| | | | $R_L = 150\Omega$ | | 0.03 | | |
| Input Noise-Voltage Density | e_n | $f = 10kHz$ | | | 2 | | nV/ \sqrt{Hz} |
| Input Noise-Current Density | i_n | $f = 10kHz$ | IN+ | | 4 | | pA/ \sqrt{Hz} |
| | | | IN- | | 5 | | |
| Input Capacitance (Positive Input) | C_{IN+} | | | | 1.5 | | pF |
| Output Impedance | Z_{OUT} | $f = 10kHz$ | | | 4.8 | | Ω |
| Disabled Output Capacitance | $C_{OUT(OFF)}$ | $\overline{SHDN} \leq V_{IL}$, $1.2V \leq V_{OUT} \leq 3.8V$ (Notes 2, 4) | | | 4 | | pF |
| Turn-On Time from \overline{SHDN} | t_{ON} | (Note 4) | | | 40 | | ns |
| Turn-Off Time to \overline{SHDN} | t_{OFF} | (Note 4) | | | 400 | | ns |
| Power-Up Time | | | | | 200 | | μs |
| Off-Isolation | | $\overline{SHDN} \leq 2V$, $R_L = 150\Omega$, $f = 10MHz$ | | | -60 | | dB |
| Crosstalk | | $f = 10MHz$, MAX4182/MAX4183/MAX4186 | | | -60 | | dB |
| Gain Matching to 0.1dB | | $f = 10MHz$, MAX4182/MAX4183/MAX4186 | | | 25 | | MHz |

AC ELECTRICAL CHARACTERISTICS—Single Supply (MAX4181/4184/4185/4187)

($V_{CC} = +5V$, $V_{EE} = 0$, $V_{IN+} = 2.5V$, $\overline{SHDN} \geq 3V$, $A_v = +1V/V$; see Table 1 for R_F values; $T_A = +25^\circ C$, unless otherwise noted.)

| PARAMETER | SYMBOL | CONDITIONS | | MIN | TYP | MAX | UNITS |
|---------------------------------------|-----------------|---------------------------------------|-------------------|-----|------|-----|------------|
| Small-Signal -3dB Bandwidth (Note 5) | BW_{SS} | <0.5dB peaking | $R_L = 1k\Omega$ | 175 | 220 | | MHz |
| | | | $R_L = 150\Omega$ | | 170 | | |
| Large-Signal -3dB Bandwidth | BW_{LS} | $V_{OUT} = 2Vp-p$, $R_L = 1k\Omega$ | | | 110 | | MHz |
| Bandwidth for 0.1dB Flatness (Note 5) | $BW_{0.1dB}$ | $R_L = 1k\Omega$ | | 16 | 40 | | MHz |
| | | $R_L = 150\Omega$ | | | 30 | | |
| Slew Rate (Note 5) | SR | $V_{OUT} = 2V$ step, $R_L = 1k\Omega$ | Rising edge | 210 | 275 | | V/ μs |
| | | | Falling edge | 170 | 215 | | |
| Settling Time to 0.1% | t_s | $V_{OUT} = 2V$ step, $R_L = 1k\Omega$ | | | 22 | | ns |
| Rise/Fall Time | t_R and t_F | $V_{OUT} = 2V$ step, $R_L = 1k\Omega$ | | | 7 | | ns |
| Spurious-Free Dynamic Range | SFDR | $f_C = 5MHz$, $V_{OUT} = 2Vp-p$ | $R_L = 1k\Omega$ | | 55 | | dB |
| | | | $R_L = 150\Omega$ | | 59 | | |
| Second Harmonic Distortion | | $f_C = 5MHz$, $V_{OUT} = 2Vp-p$ | $R_L = 1k\Omega$ | | -61 | | dBc |
| | | | $R_L = 150\Omega$ | | -72 | | |
| Third Harmonic Distortion | | $f_C = 5MHz$, $V_{OUT} = 2Vp-p$ | $R_L = 1k\Omega$ | | -55 | | dBc |
| | | | $R_L = 150\Omega$ | | -59 | | |
| Differential Phase Error | DP | NTSC | $R_L = 1k\Omega$ | | 0.01 | | degrees |
| | | | $R_L = 150\Omega$ | | 0.35 | | |

Single/Dual/Quad, 270MHz, 1mA, SOT23, Current-Feedback Amplifiers with Shutdown

AC ELECTRICAL CHARACTERISTICS—Single Supply (MAX4181/4184/4185/4187) (cont.)

($V_{CC} = +5V$, $V_{EE} = 0$, $V_{IN+} = 2.5V$, $\overline{SHDN} \geq 3V$, $A_V = +1V/V$; see Table 1 for R_F values; $T_A = +25^\circ C$, unless otherwise noted.)

| PARAMETER | SYMBOL | CONDITIONS | MIN | TYP | MAX | UNITS |
|-------------------------------------|----------------|--|-------------------|------|-----|----------------|
| Differential Gain Error | DG | NTSC | $R_L = 1k\Omega$ | 0.10 | | % |
| | | | $R_L = 150\Omega$ | 0.03 | | |
| Input Noise-Voltage Density | e_n | $f = 10kHz$ | | 2 | | nV/\sqrt{Hz} |
| Input Noise-Current Density | i_n | $f = 10kHz$ | IN+ | 4 | | pA/\sqrt{Hz} |
| | | | IN- | 5 | | |
| Input Capacitance (Positive Input) | C_{IN+} | | | 1.5 | | pF |
| Output Impedance | Z_{OUT} | $f = 10kHz$ | | 4.8 | | Ω |
| Disabled Output Capacitance | $C_{OUT(OFF)}$ | $\overline{SHDN} \leq V_{IL}$, $1.2V \leq V_{OUT} \leq 3.8V$ (Notes 2, 4) | | 4 | | pF |
| Turn-On Time from \overline{SHDN} | t_{ON} | (Note 4) | | 40 | | ns |
| Turn-Off Time to \overline{SHDN} | t_{OFF} | (Note 4) | | 400 | | ns |
| Power-Up Time | | | | 200 | | μs |
| Off-Isolation | | $\overline{SHDN} \leq 2V$, $R_L = 150\Omega$, $f = 10MHz$ | | -54 | | dB |
| Crosstalk | | $f = 10MHz$, MAX4184/MAX4185/MAX4187 | | -60 | | dB |
| Gain Matching to 0.1dB | | $f = 10MHz$, MAX4184/MAX4185/MAX4187 | | 25 | | MHz |

Note 1: The MAX418_EUT is 100% production tested at $T_A = +25^\circ C$. Specifications over temperature limits are guaranteed by design.

Note 2: Does not include current into the external-feedback network.

Note 3: Over operating supply-voltage range.

Note 4: Specification applies to MAX4180/MAX4181/MAX4183 and MAX4185.

Note 5: The AC specifications shown are not measured in a production test environment. The minimum AC specifications given are based on the combination of worst-case design simulations along with a sample characterization of units. These minimum specifications are for design guidance only and are not intended to guarantee AC performance (see *AC Testing/Performance*). For 100% testing of those parameters, contact the factory.

Typical Operating Characteristics

($V_{CC} = +5V$, $V_{EE} = -5V$, $T_A = +25^\circ C$, unless otherwise noted.)

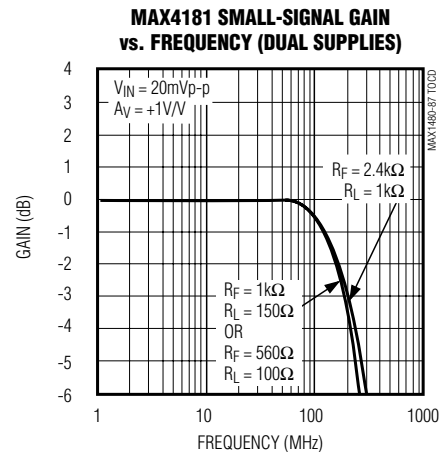
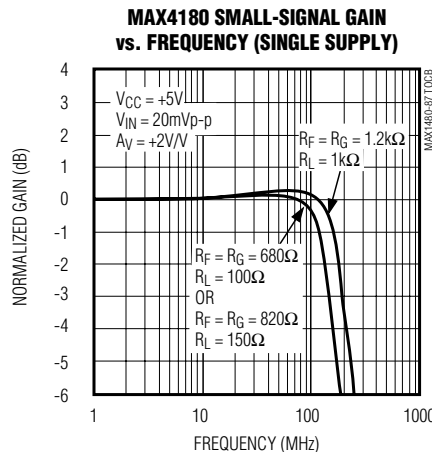
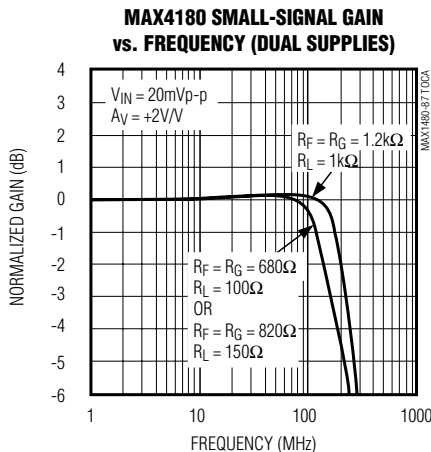

Single/Dual/Quad, 270MHz, 1mA, SOT23, Current-Feedback Amplifiers with Shutdown

Typical Operating Characteristics (continued)

($V_{CC} = +5V$, $V_{EE} = -5V$, $T_A = +25^\circ C$, unless otherwise noted.)

MAX4180-MAX4187

MAX4181 SMALL-SIGNAL GAIN vs. FREQUENCY (SINGLE SUPPLY)

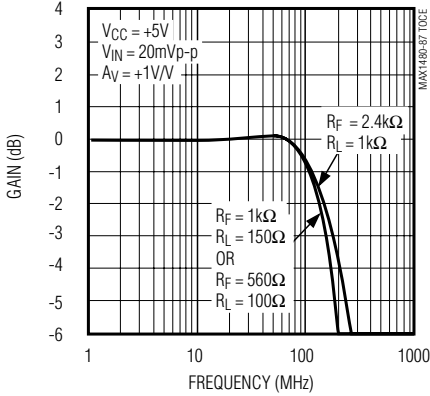

MAX4182/MAX4183 SMALL-SIGNAL GAIN vs. FREQUENCY (DUAL SUPPLIES)

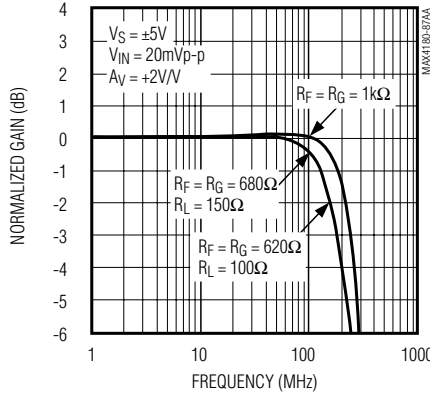

MAX4184/MAX4185 SMALL-SIGNAL GAIN vs. FREQUENCY (DUAL SUPPLIES)

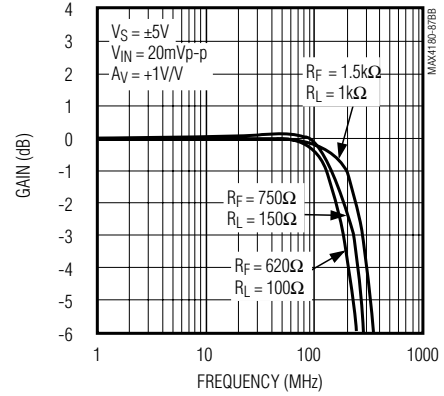

MAX4186 SMALL-SIGNAL GAIN vs. FREQUENCY (DUAL SUPPLIES)

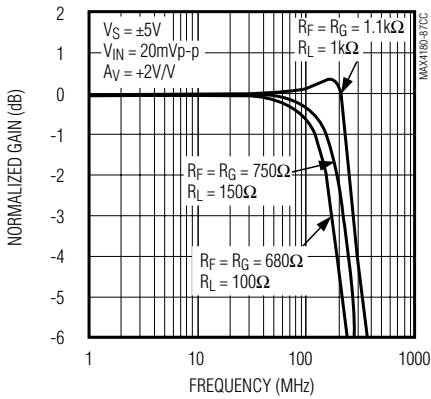

MAX4187 SMALL-SIGNAL GAIN vs. FREQUENCY

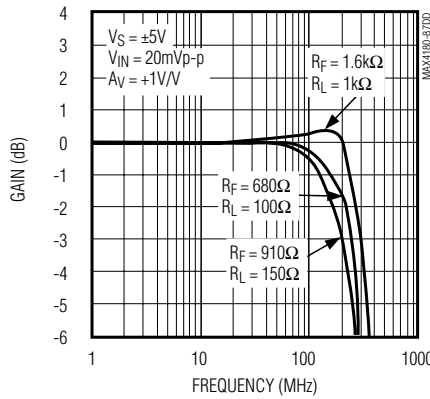

MAX4180 GAIN FLATNESS vs. FREQUENCY (SINGLE & DUAL SUPPLIES)

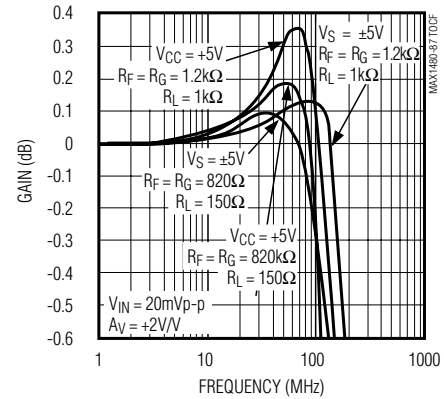

MAX4181 GAIN FLATNESS vs. FREQUENCY (SINGLE & DUAL SUPPLIES)

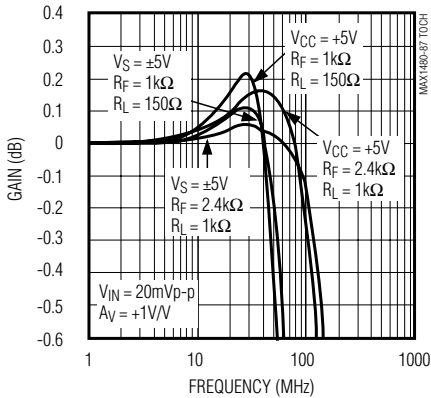

MAX4180 LARGE-SIGNAL GAIN vs. FREQUENCY (DUAL SUPPLIES)

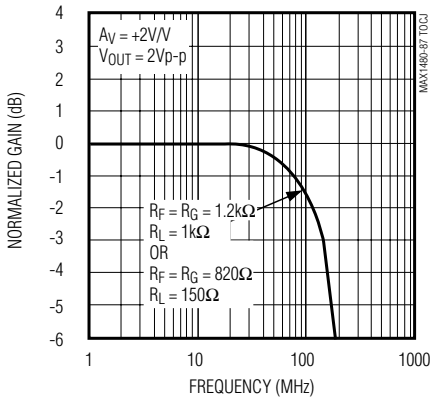

MAX4180 LARGE-SIGNAL GAIN vs. FREQUENCY (SINGLE SUPPLY)

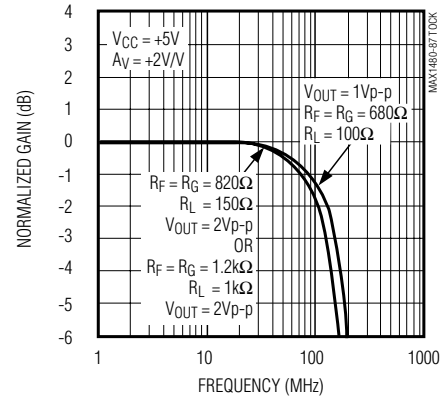

Single/Dual/Quad, 270MHz, 1mA, SOT23, Current-Feedback Amplifiers with Shutdown

Typical Operating Characteristics (continued)

($V_{CC} = +5V$, $V_{EE} = -5V$, $T_A = +25^\circ C$, unless otherwise noted.)

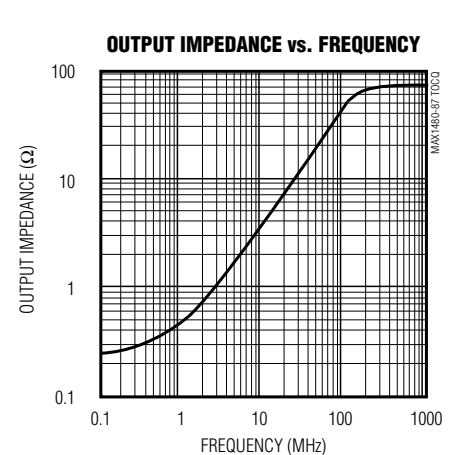
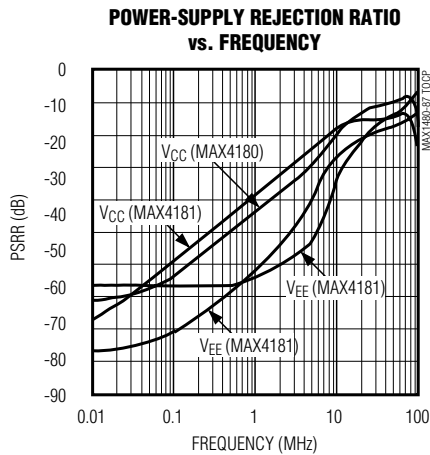
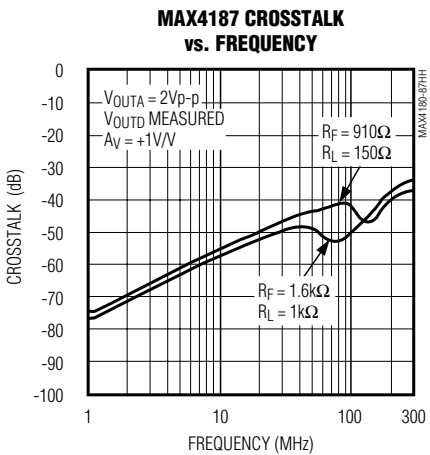
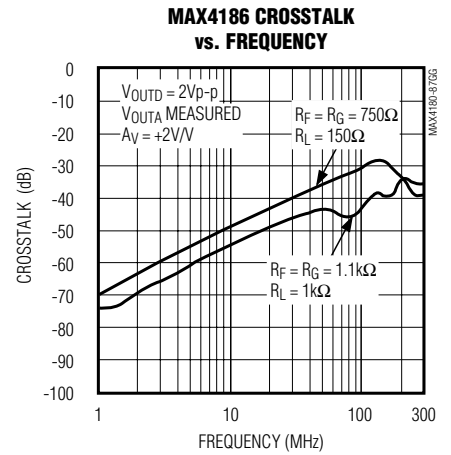
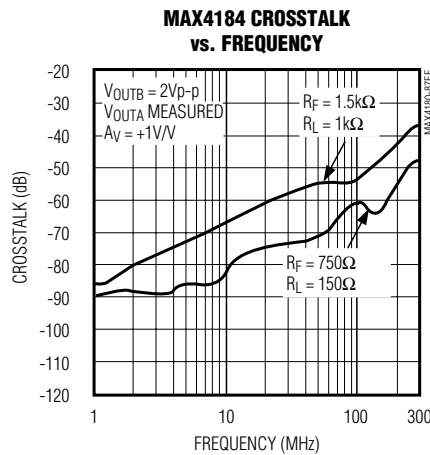
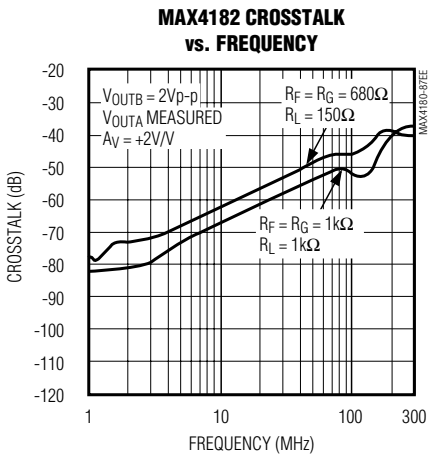
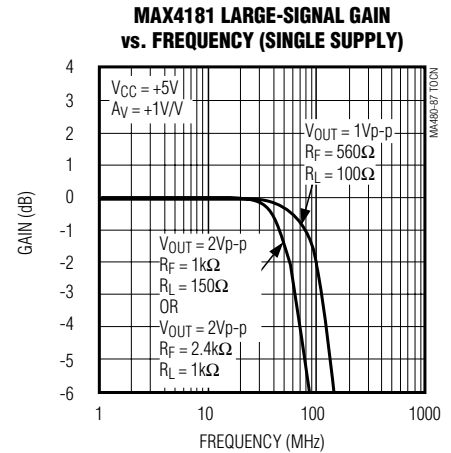
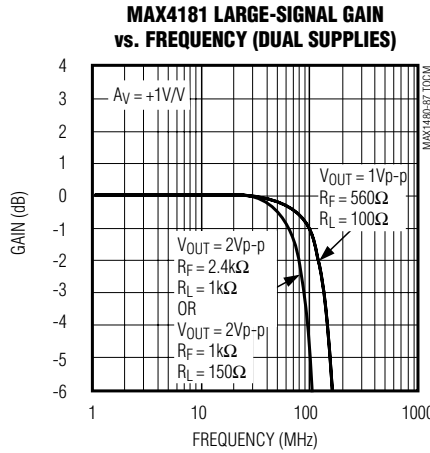
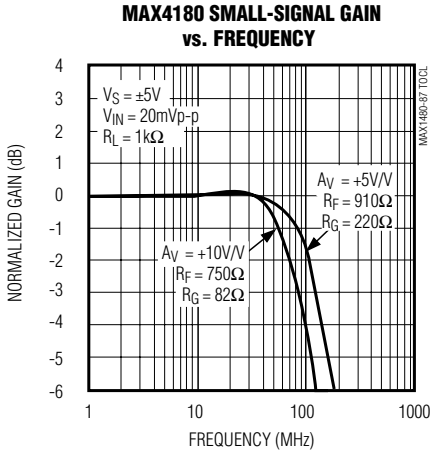

Single/Dual/Quad, 270MHz, 1mA, SOT23, Current-Feedback Amplifiers with Shutdown

Typical Operating Characteristics (continued)

($V_{CC} = +5V$, $V_{EE} = -5V$, $T_A = +25^\circ C$, unless otherwise noted.)

MAX4180-MAX4187

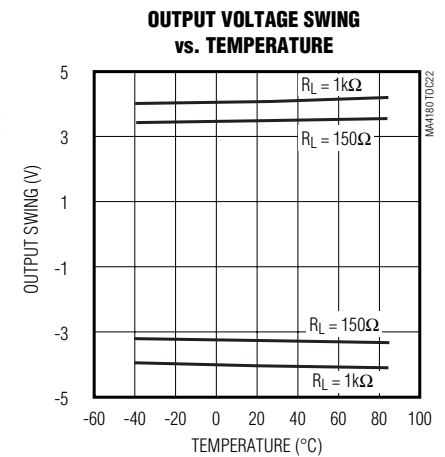
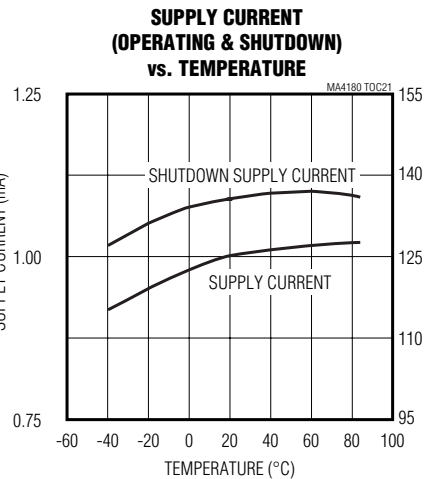
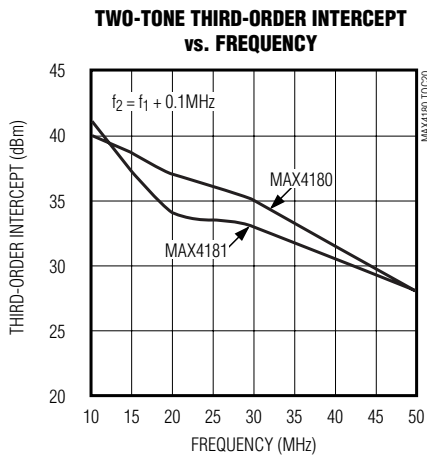
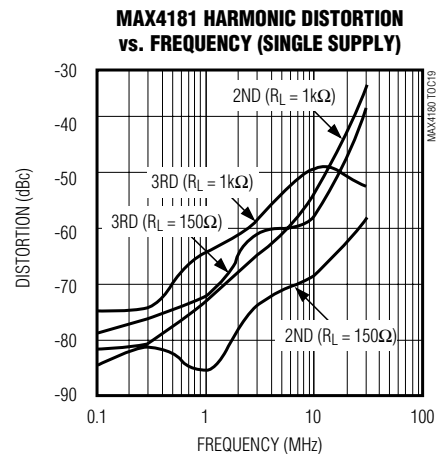
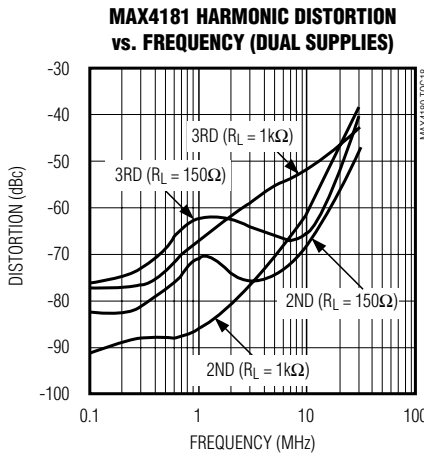
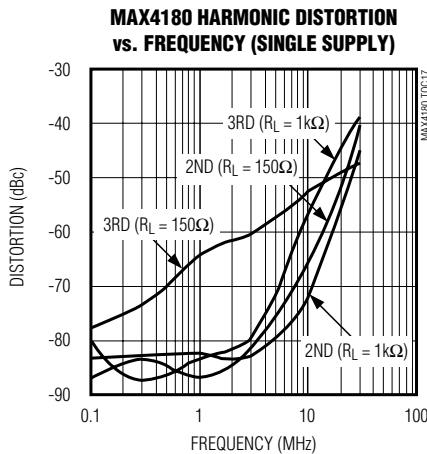
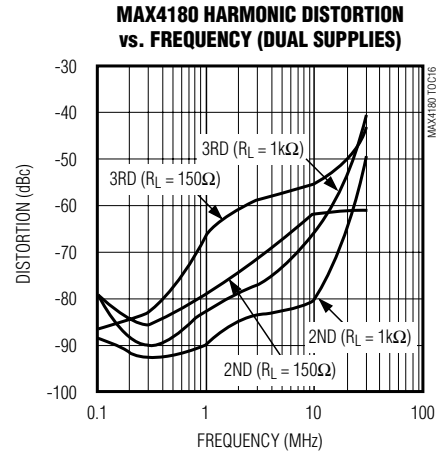
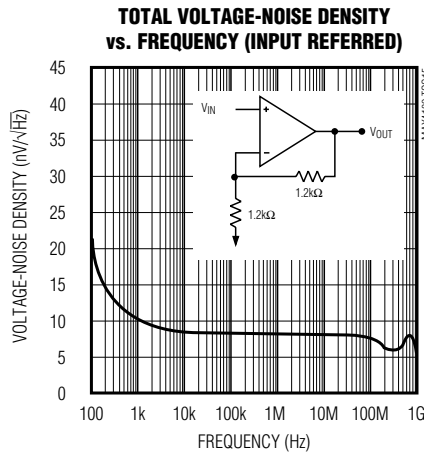
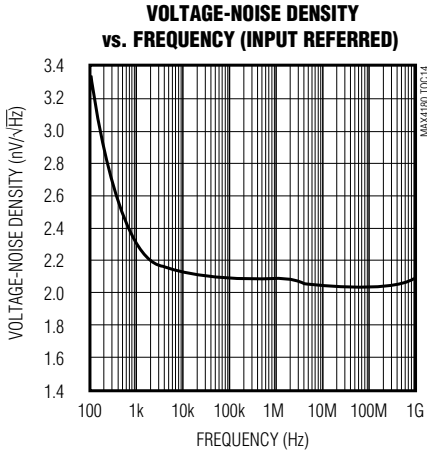

Single/Dual/Quad, 270MHz, 1mA, SOT23, Current-Feedback Amplifiers with Shutdown

Typical Operating Characteristics (continued)

($V_{CC} = +5V$, $V_{EE} = -5V$, $T_A = +25^\circ C$, unless otherwise noted.)

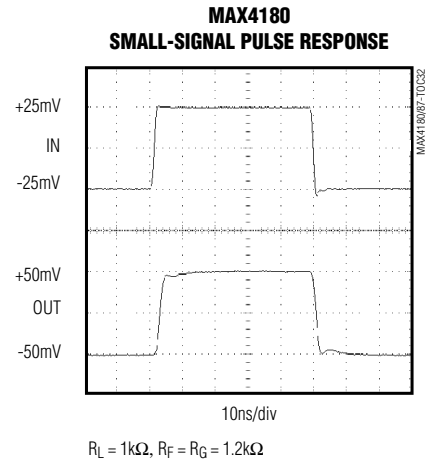
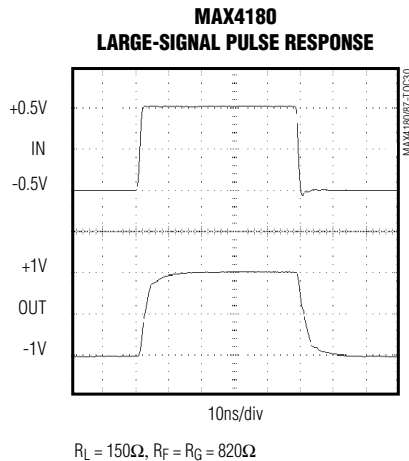
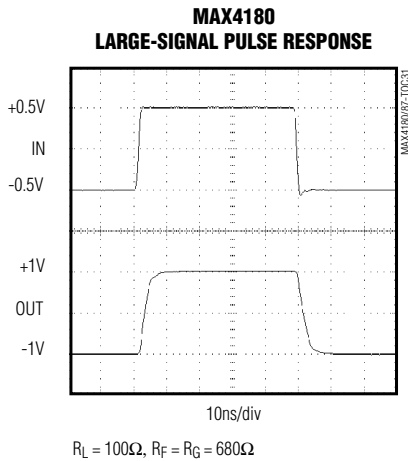
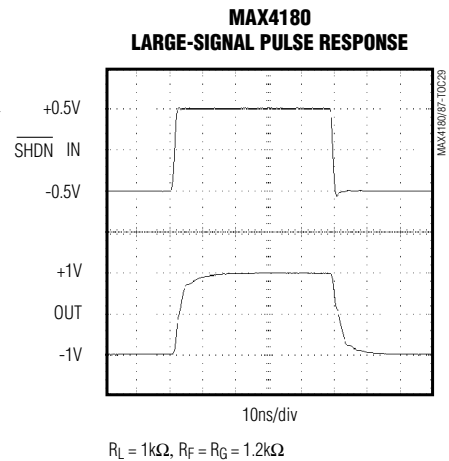
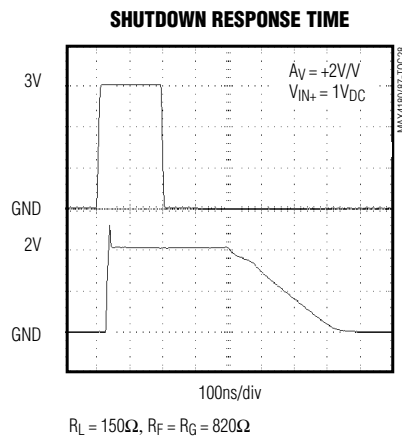
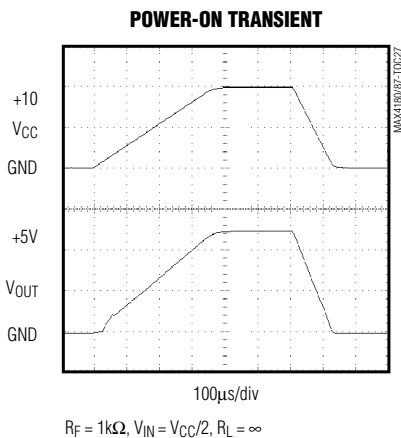
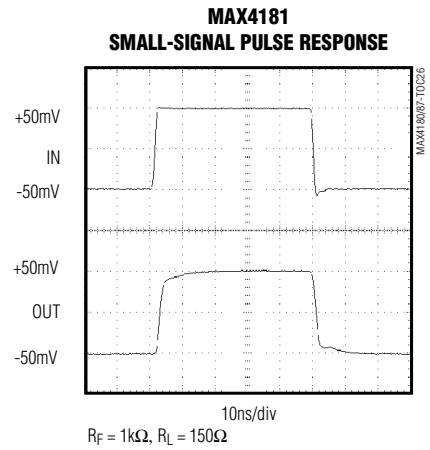
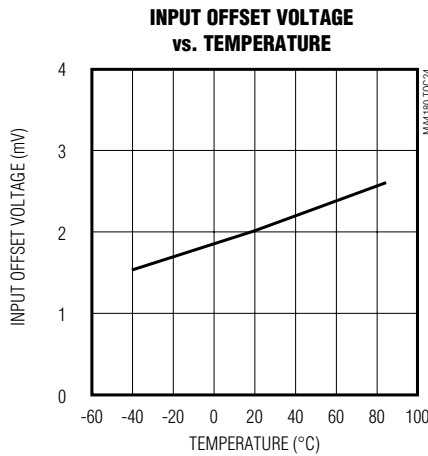
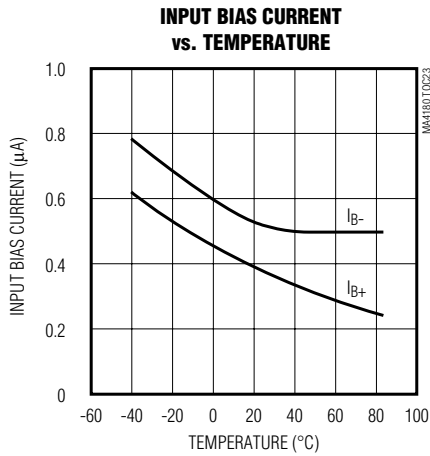

Single/Dual/Quad, 270MHz, 1mA, SOT23, Current-Feedback Amplifiers with Shutdown

Typical Operating Characteristics (continued)

($V_{CC} = +5V$, $V_{EE} = -5V$, $T_A = +25^\circ C$, unless otherwise noted.)

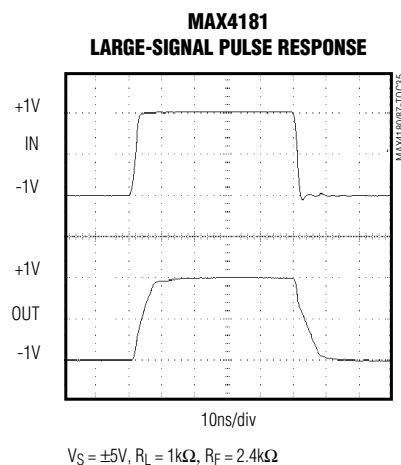
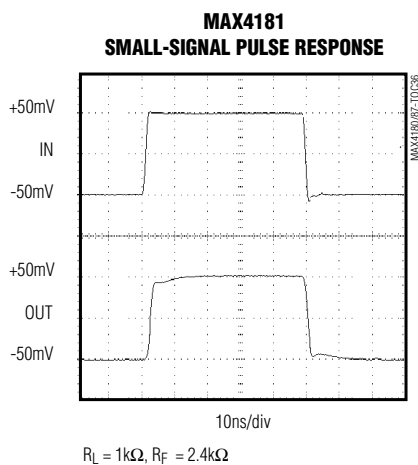
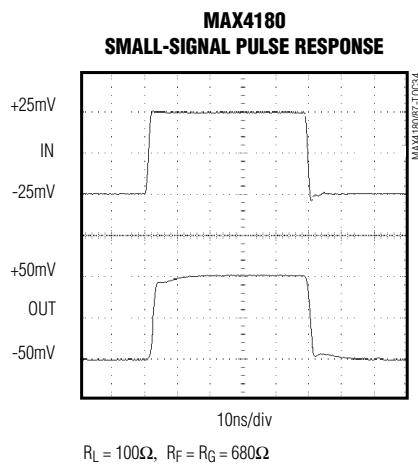
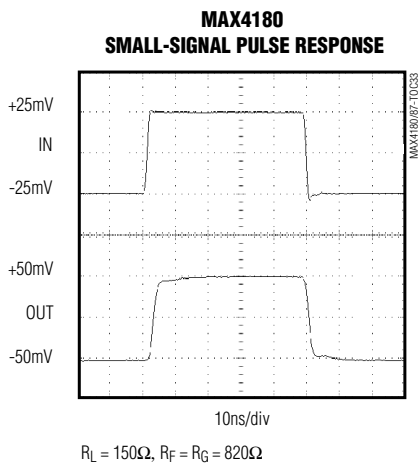

Pin Description

MAX4180/MAX4181

| PIN | | NAME | FUNCTION |
|-----------------|---------|-------------------|--|
| MAX4180/MAX4181 | | | |
| SO | SOT23-6 | | |
| 1, 5 | — | N.C. | No Connection. Not internally connected. |
| 2 | 4 | IN- | Inverting Input |
| 3 | 3 | IN+ | Noninverting Input |
| 4 | 2 | V_{EE} | Negative Power Supply. Connect V_{EE} to -5V or ground for single-supply operation. |
| 6 | 1 | OUT | Amplifier Output |
| 7 | 6 | V_{CC} | Positive Power Supply. Connect V_{CC} to +5V. |
| 8 | 5 | \overline{SHDN} | Shutdown Input. Device is enabled when $\overline{SHDN} \geq (V_{CC} - 2V)$ and disabled when $\overline{SHDN} \leq (V_{CC} - 3V)$. |

Single/Dual/Quad, 270MHz, 1mA, SOT23, Current-Feedback Amplifiers with Shutdown

Pin Description (continued)

MAX4182/MAX4183/MAX4184/MAX4185

| PIN | | | NAME | FUNCTION |
|--------------------|--------------------|--------------------|-----------------|--|
| MAX4182 MAX4184 | MAX4183 MAX4185 | MAX4183 MAX4185 | | |
| SO | SO | μMAX | | |
| 1 | 1 | 1 | OUTA | Amplifier A Output |
| 2 | 2 | 2 | INA- | Amplifier A Inverting Input |
| 3 | 3 | 3 | INA+ | Amplifier A Noninverting Input |
| 4 | 4 | 4 | V _{EE} | Negative Power Supply. Connect V _{EE} to -5V or ground for single-supply operation. |
| — | 5, 7, 8, 10 | — | N.C. | No Connection. Not internally connected. |
| — | 6 | 5 | SHDNA | Shutdown Control Input for Amplifier A. Amplifier A is enabled when SHDNA ≥ (V _{CC} - 2V) and disabled when SHDNA ≤ (V _{CC} - 3V). |
| — | 9 | 6 | SHDNB | Shutdown Control Input for Amplifier B. Amplifier B is enabled when SHDNB ≥ (V _{CC} - 2V) and disabled when SHDNB ≤ (V _{CC} - 3V). |
| 5 | 11 | 7 | INB+ | Amplifier B Noninverting Input |
| 6 | 12 | 8 | INB- | Amplifier B Inverting Input |
| 7 | 13 | 9 | OUTB | Amplifier B Output |
| 8 | 14 | 10 | V _{CC} | Positive Power Supply. Connect V _{CC} to +5V. |

MAX4186/MAX4187

| PIN | | NAME | FUNCTION |
|--------------------|--------------------|-----------------|--|
| MAX4186 MAX4187 | MAX4186 MAX4187 | | |
| SO | QSOP | | |
| 1 | 1 | OUTA | Amplifier A Output |
| 2 | 2 | INA- | Amplifier A Inverting Input |
| 3 | 3 | INA+ | Amplifier A Noninverting Input |
| 4 | 4 | V _{CC} | Positive Power Supply. Connect V _{CC} to +5V. |
| 5 | 5 | INB+ | Amplifier B Noninverting Input |
| 6 | 6 | INB- | Amplifier B Inverting Input |
| 7 | 7 | OUTB | Amplifier B Output |
| — | 8, 9 | N.C. | No Connection. Not internally connected. |
| 8 | 10 | OUTC | Amplifier C Output |
| 9 | 11 | INC- | Amplifier C Inverting Input |
| 10 | 12 | INC+ | Amplifier C Noninverting Input |
| 11 | 13 | V _{EE} | Negative Power Supply. Connect V _{EE} to -5V or ground for single-supply operation. |
| 12 | 14 | IND+ | Amplifier D Noninverting Input |
| 13 | 15 | IND- | Amplifier D Inverting Input |
| 14 | 16 | OUTD | Amplifier D Output |

Single/Dual/Quad, 270MHz, 1mA, SOT23, Current-Feedback Amplifiers with Shutdown

MAX4180-MAX4187

Detailed Description

The MAX4180–MAX4187 are ultra-low-power current-feedback amplifiers featuring bandwidths up to 270MHz, 0.1dB gain flatness to 90MHz, and low differential gain (0.08%) and phase (0.03°) errors. These amplifiers achieve ultra-high bandwidth-to-power ratios with low distortion, wide signal swing, and excellent load-driving capabilities. They are optimized for ±5V supplies but also operate from a single +5V supply while consuming only 1mA per amplifier. With ±60mA output current drive capability, the devices achieve low distortion even while driving 150Ω loads.

Wide bandwidth, low power, low differential phase and gain error, and excellent gain flatness make the MAX4180–MAX4187 ideal for use in portable video equipment such as cameras, video switchers, and other battery-powered applications. Their two-stage design provides higher gain and lower distortion than conventional single-stage, current-feedback topologies. This feature, combined with fast settling time, makes these devices suitable for buffering high-speed analog-to-digital converters (ADCs).

The MAX4180/MAX4181/MAX4183/MAX4185 have a low-power shutdown mode that is activated by driving the amplifiers' $\overline{\text{SHDN}}$ input low. Placing them in shutdown reduces quiescent supply current to 135μA (typ) and places amplifier outputs in a high-impedance state. These amplifiers can be used to implement a high-speed multiplexer by connecting together the outputs of multiple amplifiers and controlling the $\overline{\text{SHDN}}$ inputs to enable one amplifier and disable all the others. The disabled amplifiers present very little load (0.1μA leakage current and 4pF capacitance) to the active amplifiers' output. Note that the feedback network impedance of all the disabled amplifiers must be considered when calculating the total load on the active amplifier output.

Application Information

Theory of Operation

The MAX4180–MAX4187 are current-feedback amplifiers, and their open-loop transfer function is expressed as a transimpedance, $\Delta V_{\text{OUT}}/\Delta I_{\text{IN}}$, or T_Z . The frequency behavior of the open-loop transimpedance is similar to the open-loop gain of a voltage-mode feedback amplifier. That is, it has a large DC value and decreases at approximately 6dB per octave.

Analyzing the follower with gain, as shown in Figure 1, yields the following transfer function:

$$V_{\text{OUT}} / V_{\text{IN}} = G \times [(T_Z(s) / T_Z(s) + G \times (R_{\text{IN}} + R_{\text{F}})]$$

where $G = A_{\text{VCL}} = 1 + (R_{\text{F}} / R_{\text{G}})$, and $R_{\text{IN}} = 1 / g_{\text{M}} \approx 160\Omega$.

At low gains, $G \times R_{\text{IN}} < R_{\text{F}}$. Therefore, the closed-loop bandwidth is essentially independent of closed-loop gain. Similarly, $T_Z > R_{\text{F}}$ at low frequencies, so that:

$$\frac{V_{\text{OUT}}}{V_{\text{IN}}} = G = 1 + (R_{\text{F}} / R_{\text{G}})$$

Layout and Power-Supply Bypassing

The MAX4180–MAX4187 have an RF bandwidth and, consequently, require careful board layout, including the possible use of constant-impedance microstrip or stripline techniques.

To realize the full AC performance of these high-speed amplifiers, pay careful attention to power-supply bypassing and board layout. The PC board should have at least two layers: a signal and power layer on one side, and a large, low-impedance ground plane on the other side. The ground plane should be as free of voids as possible. With multilayer boards, locate the ground plane on a layer that incorporates no signal or power traces.

Regardless of whether a constant-impedance board is used, observe the following guidelines when designing the board:

- Do not use wire-wrap boards. They are too inductive.
- Do not use breadboards. They are too capacitive.
- Do not use IC sockets. They increase parasitic capacitance and inductance.
- Use surface-mount components rather than through-hole components. They give better high-frequency performance, have shorter leads, and have lower parasitic reactances.

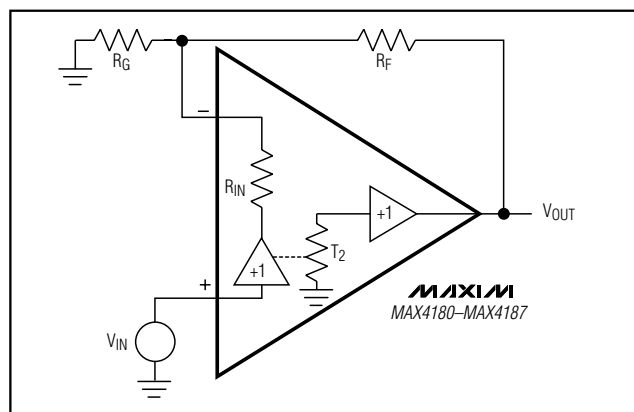

Figure 1. Current-Feedback Amplifier

Single/Dual/Quad, 270MHz, 1mA, SOT23, Current-Feedback Amplifiers with Shutdown

- Keep lines as short and as straight as possible.
- Do not make 90° turns; round all corners.
- Observe high-frequency bypassing techniques to maintain the amplifiers' accuracy. The bypass capacitors should include a 0.01μF to 0.1μF ceramic capacitor between each supply pin and the ground plane, located as close to the package as possible.
- Place a 1μF ceramic capacitor in parallel with each 0.01μF to 0.1μF capacitor as close to them as possible.
- Place a 10μF to 15μF low-ESR tantalum at the point of entry to the power-supply pins' PC board. The power-supply trace should lead directly from the tantalum capacitor to the VCC and VEE pins.
- Keep PC traces short and use surface-mount components to minimize parasitic inductance.

Maxim's High-Speed Evaluation Board

Figures 2 and 3 show layouts of Maxim's high-speed single SOT23 and SO evaluation boards. These boards were developed using the techniques described above. The smallest available surface-mount resistors were used for feedback and back-termination to minimize their distance from the part, reducing the capacitance associated with longer lead lengths.

SMA connectors were used for best high-frequency performance. Because distances are extremely short, performance is unaffected by the fact that inputs and outputs do not match a 50Ω line. However, in applications that require lead lengths greater than one-quarter of the wavelength of the highest frequency of interest, use constant-impedance traces.

Fully assembled evaluation boards are available for the MAX4180ESA.

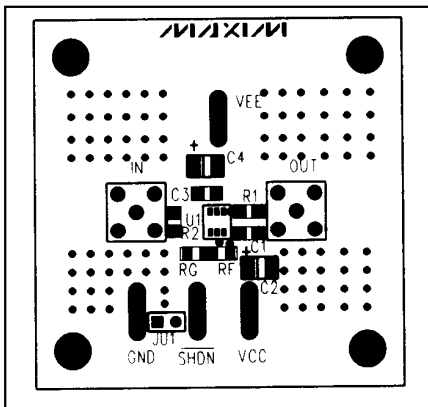

Figure 2a. SOT23 High-Speed EV Board Component Placement Guide—Component Side

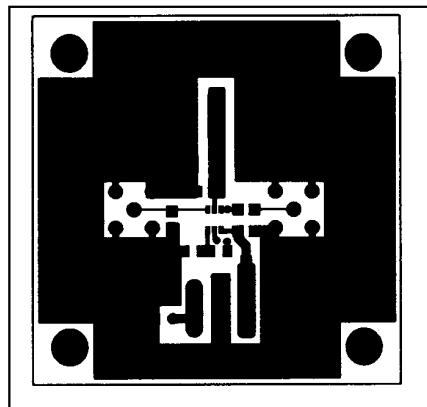

Figure 2b. SOT23 High-Speed EV Board Layout—Component Side

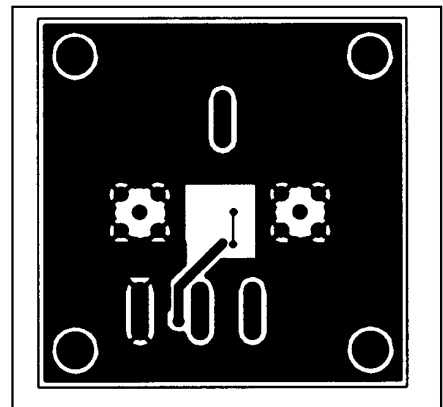

Figure 2c. High-Speed EV Board Layout—Solder Side

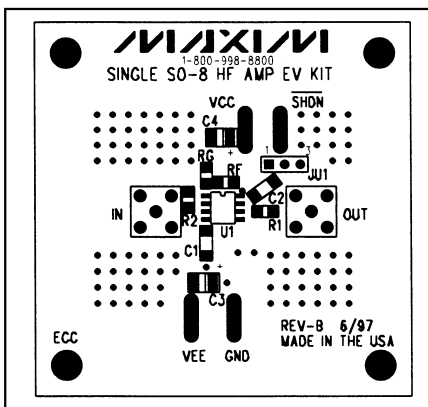

Figure 3a. SO-8 High-Speed EV Board Component Placement Guide—Component Side

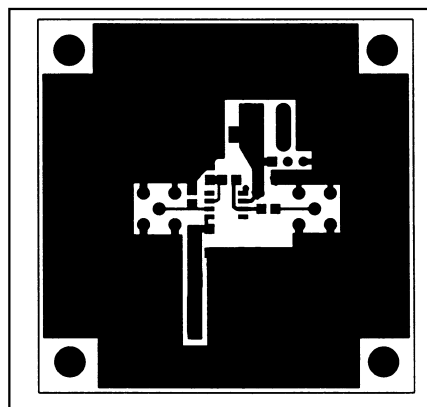

Figure 3b. SO-8 High-Speed EV Board Layout—Component Side

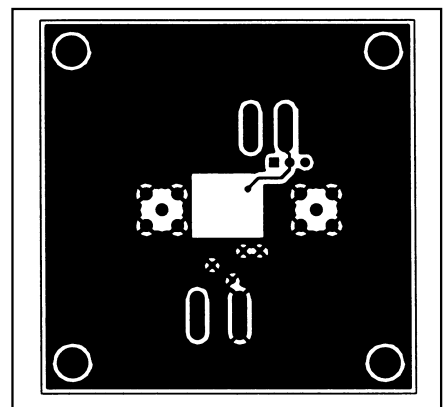

Figure 3c. SO-8 High-Speed EV Board Layout—Solder Side

Single/Dual/Quad, 270MHz, 1mA, SOT23, Current-Feedback Amplifiers with Shutdown

MAX4180-MAX4187

Table 1. Recommended Component Values

| COMPONENT/BW | MAX4180 | | | | | MAX4181 | | |
|--------------------|------------------|-------------------|-------------------|----------------------------|----------------------------|------------------|-------------------|-------------------|
| | $A_V = +2V/V$ | | | $A_V = +5V/V$ | $A_V = +10V/V$ | $A_V = +1V/V$ | | |
| | $R_L = 1k\Omega$ | $R_L = 150\Omega$ | $R_L = 100\Omega$ | $R_L = 1k\Omega/150\Omega$ | $R_L = 1k\Omega/150\Omega$ | $R_L = 1k\Omega$ | $R_L = 150\Omega$ | $R_L = 100\Omega$ |
| R_F (Ω) | 1.2k | 820 | 680 | 520 | 560 | 2.4k | 1k | 560 |
| R_G (Ω) | 1.2k | 820 | 680 | 130 | 56 | — | — | — |
| -3dB BW (MHz) | 245 | 190 | 190 | 120 | 76 | 270 | 205 | 200 |

| COMPONENT/ BW | MAX4182/MAX4183 | | | MAX4184/MAX4185 | | | MAX4186 | | | MAX4187 | | |
|--------------------|------------------|-------------------|-------------------|------------------|-------------------|-------------------|------------------|-------------------|-------------------|------------------|-------------------|-------------------|
| | $A_V = +2V/V$ | | | $A_V = +1V/V$ | | | $A_V = +2V/V$ | | | $A_V = +1V/V$ | | |
| | $R_L = 1k\Omega$ | $R_L = 150\Omega$ | $R_L = 100\Omega$ | $R_L = 1k\Omega$ | $R_L = 150\Omega$ | $R_L = 100\Omega$ | $R_L = 1k\Omega$ | $R_L = 150\Omega$ | $R_L = 100\Omega$ | $R_L = 1k\Omega$ | $R_L = 150\Omega$ | $R_L = 100\Omega$ |
| R_F (Ω) | 1k | 680 | 620 | 1.5k | 750 | 620 | 1.1k | 750 | 680 | 1.6k | 910 | 680 |
| R_G (Ω) | 1k | 680 | 620 | — | — | — | 1.1k | 750 | 680 | — | — | — |
| -3dB BW (MHz) | 245 | 190 | 160 | 270 | 205 | 180 | 245 | 190 | 175 | 270 | 205 | 200 |

Choosing Feedback and Gain Resistors

The optimum value of the external-feedback (R_F) and gain-setting (R_G) resistors used with the MAX4180–MAX4187 depends on the closed-loop gain and the application circuit's load. Table 1 lists the optimum resistor values for some specific gain configurations. One-percent resistor values are preferred to maintain consistency over a wide range of production lots. Figures 4a and 4b show the standard inverting and noninverting configurations. **Note:** The noninverting circuit gain (Figure 4) is 1 plus the magnitude of the inverting closed-loop gain. Otherwise, the two circuits are identical.

DC and Noise Errors

Several major error sources must be considered in any op amp. These apply equally to the MAX4180–MAX4187. Offset-error terms are given by the equation below. Voltage and current-noise errors are root-square summed and are therefore computed separately. In Figure 5, the total output offset voltage is determined by the following factors:

- The input offset voltage (V_{OS}) times the closed-loop gain ($1 = R_F / R_G$).
- The positive input bias current (I_{B+}) times the source resistor (R_S) (usually 50Ω or 75Ω), plus the negative input bias current (I_{B-}) times the parallel combination of R_G and R_F . In current-feedback amplifiers, the input bias currents at the $IN+$ and $IN-$ terminals do not track each other and may have opposite polarity, so there is no benefit to matching the resistance at both inputs.

The equation for the total DC error at the output is:

$$V_{OUT} = \left[(I_{B+})R_S + (I_{B-})(R_F \parallel R_G) + V_{OS} \right] \left(1 + \frac{R_F}{R_G} \right)$$

The total output-referred noise voltage is:

$$e_{n(OUT)} = \left(1 + \frac{R_F}{R_G} \right) \sqrt{ \left[(i_{n+})R_S \right]^2 + \left[(i_{n-})R_F \parallel R_G \right]^2 + (e_n)^2 }$$

Single/Dual/Quad, 270MHz, 1mA, SOT23, Current-Feedback Amplifiers with Shutdown

The MAX4180–MAX4187 have a very low, $2\text{nV}/\sqrt{\text{Hz}}$ noise voltage. The current noise at the positive input (i_{n+}) is $4\text{pA}/\sqrt{\text{Hz}}$, and the current noise at the inverting input is $5\text{pA}/\sqrt{\text{Hz}}$.

An example of the DC error calculations, using the MAX4180 typical data and typical operating circuit where $R_F = R_G = 1.2\text{k}\Omega$ ($R_F \parallel R_G = 600\Omega$) and $R_S = 37.5\Omega$, gives the following:

$$V_{OUT} = \left[\left(1 \times 10^{-6} \right) \times 37.5 + \left(2 \times 10^{-6} \right) \times (600) + 1.5 \times 10^{-3} \right] \times (1+1)$$

$$V_{OUT} = 4.1\text{mV}$$

Calculating the total output noise in a similar manner yields:

$$e_{n(OUT)} = (1+1) \sqrt{\left(4 \times 10^{-12} \times 37.5 \right)^2 + \left(5 \times 10^{-12} \times 255 \right)^2 + \left(2 \times 10^{-9} \right)^2}$$

$$e_{n(OUT)} = 4.8\text{nV}/\sqrt{\text{Hz}}$$

With a 200MHz system bandwidth, this calculates to $102\mu\text{VRMS}$ (approximately $612\mu\text{Vp-p}$, choosing the six-sigma value).

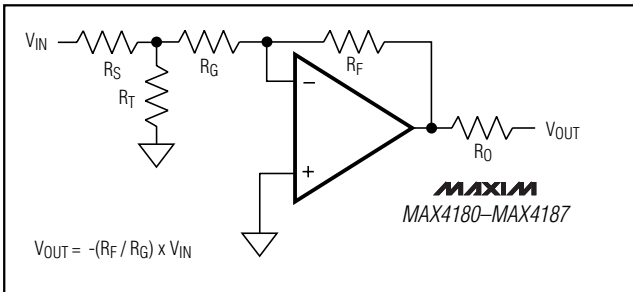

Figure 4a. Inverting Gain Configuration

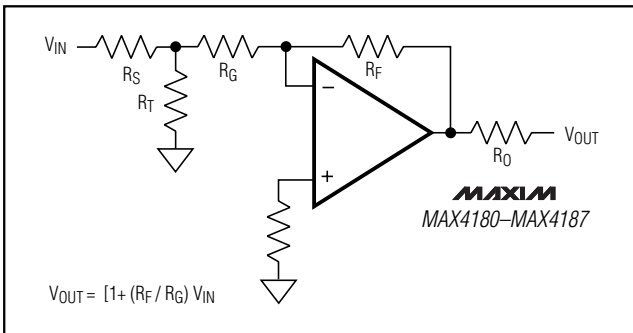

Figure 4b. Noninverting Gain Configuration

Video Line Driver

The MAX4180–MAX4187 are well suited to drive coaxial transmission lines when the cable is terminated at both ends, as shown in Figure 6. Cable-frequency response can cause variations in the signal's flatness. See Table 1 for optimum R_F and R_G values.

Driving Capacitive Loads

The MAX4180–MAX4187 are optimized for AC performance. They are not designed to drive highly capacitive loads. Reactive loads decrease phase margin and may produce excessive ringing and oscillation. Figure 7a shows a circuit that eliminates this problem. Placing the small (usually 5Ω to 22Ω) isolation resistor, R_S , before the reactive load prevents ringing and oscillation. At higher capacitive loads, the interaction of the load capacitance and isolation resistor controls AC performance. Figures 7b and 7c show the MAX4180 and MAX4181 frequency response with a 47pF capaci-

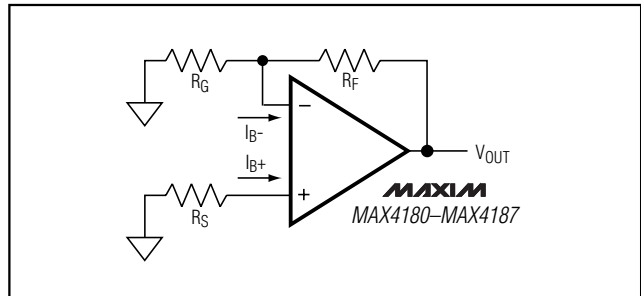

Figure 5. Output Offset Voltage

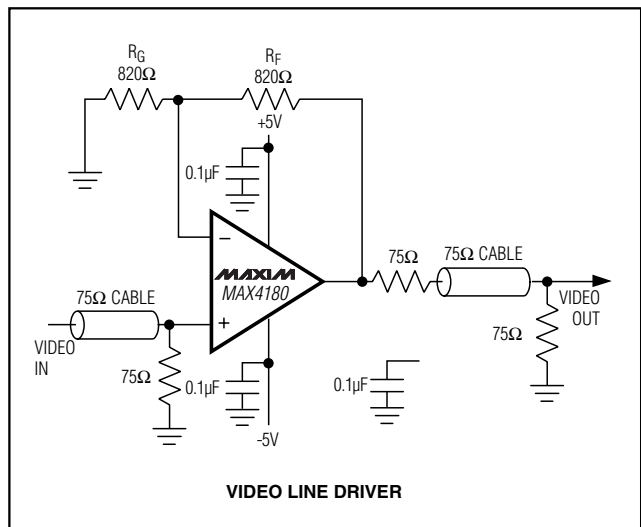

Figure 6. Video Line Driver

Single/Dual/Quad, 270MHz, 1mA, SOT23, Current-Feedback Amplifiers with Shutdown

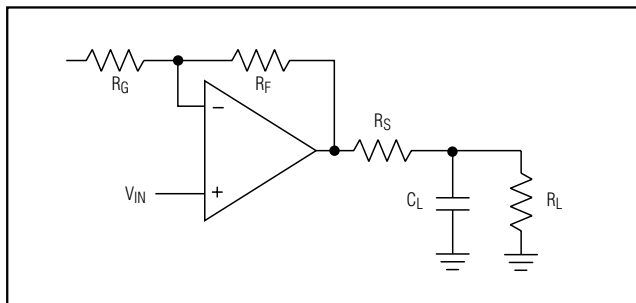

Figure 7a. Using an Isolation Resistor (R_S) for High-Capacitive Loads

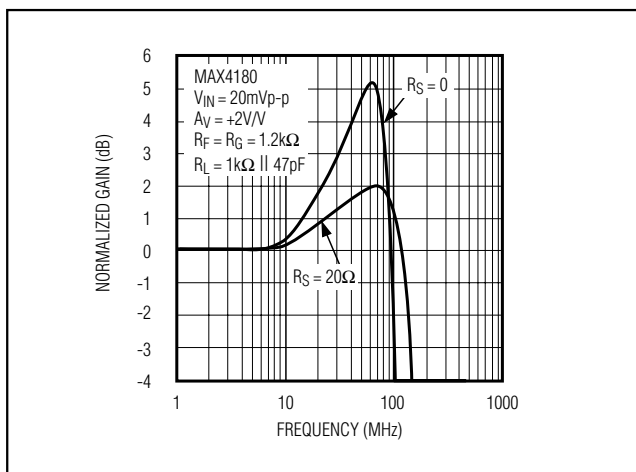

Figure 7b. Frequency Response with Capacitive Load (With and Without Isolation Resistor)

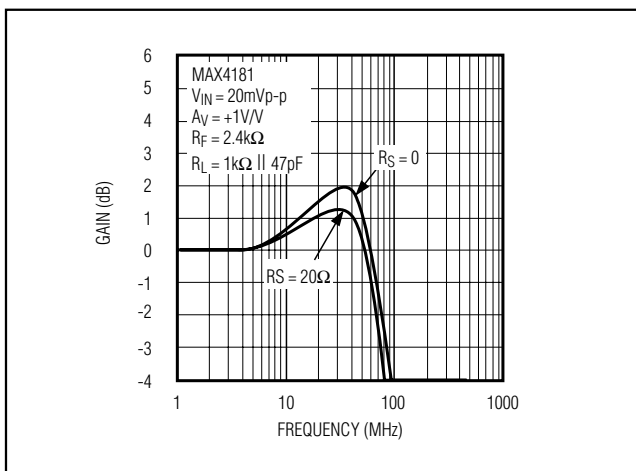

Figure 7c. Frequency Response with Capacitive Load (With and Without Isolation Resistor)

tive load. Note that in each case, gain peaking is substantially reduced when the 20Ω resistor is used to isolate the capacitive load from the amplifier output.

AC Testing/Performance

AC specifications on high-speed amplifiers are usually guaranteed without 100% production testing. Since these high-speed devices are sensitive to external parasitics introduced when automatic handling equipment is used, it is impractical to guarantee AC parameters through volume production testing. These parasitics are greatly reduced when using the recommended PC board layout (like the Maxim EV kit). Characterizing the part in this way more accurately represents the amplifier's true AC performance. Some manufacturers guarantee AC specifications without clearly stating how this guarantee is made. The AC specifications of the MAX4180-MAX4187 are derived through worst-case design simulations combined with a sample characterization of 100 units. The AC performance distributions along with the worst-case simulation results for MAX4180 and MAX4181 are shown in Figures 8-11. These distributions are repeatable provided that the proper board layout and power-supply bypassing are used (see *Layout and Power-Supply Bypassing* section).

Single/Dual/Quad, 270MHz, 1mA, SOT23, Current-Feedback Amplifiers with Shutdown

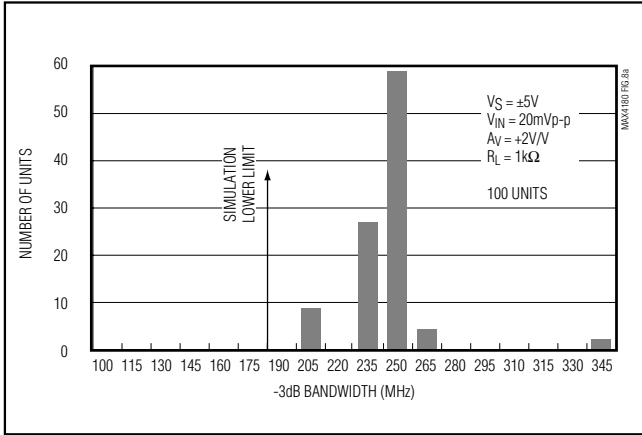

Figure 8a. MAX4180 -3dB Bandwidth Distribution (Dual Supplies)

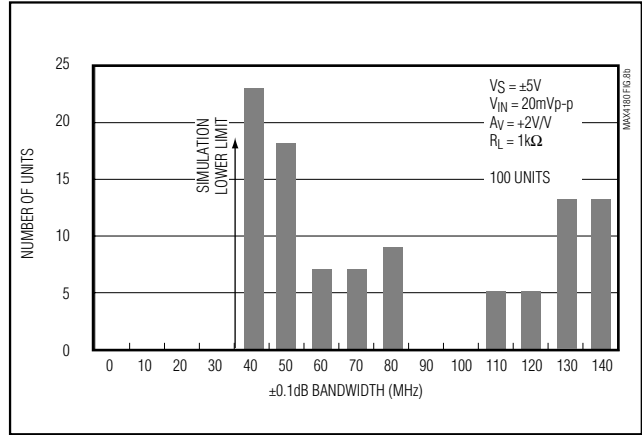

Figure 8b. MAX4180 ± 0.1 dB Bandwidth Distribution (Dual Supplies)

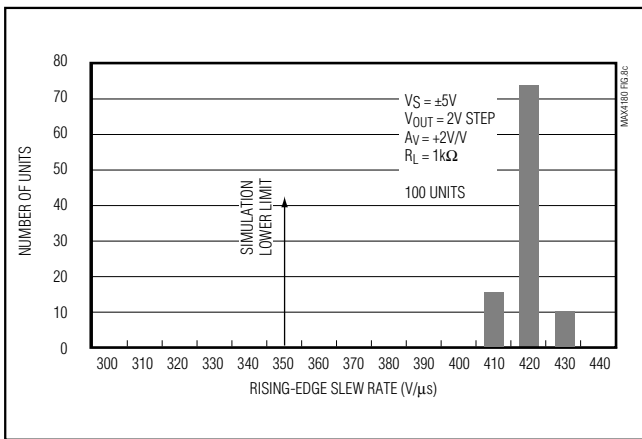

Figure 8c. MAX4180 Rising-Edge Slew-Rate Distribution (Dual Supplies)

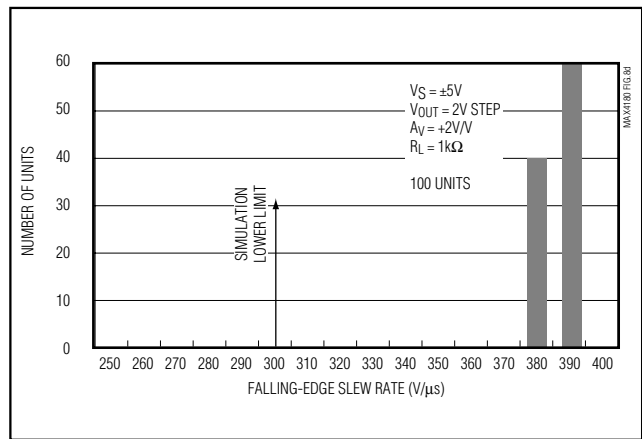

Figure 8d. MAX4180 Falling-Edge Slew-Rate Distribution (Dual Supplies)

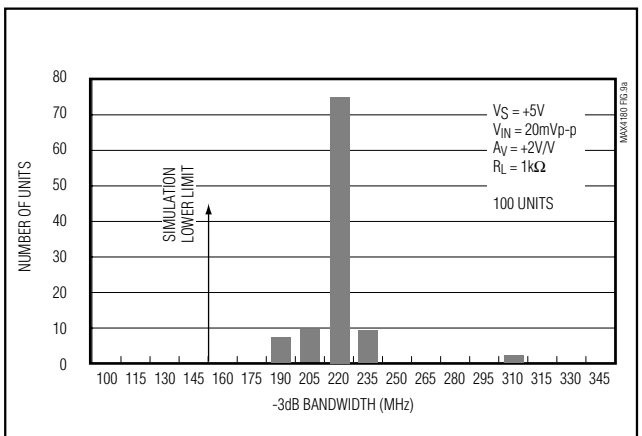

Figure 9a. MAX4180 -3dB Bandwidth Distribution (Single Supply)

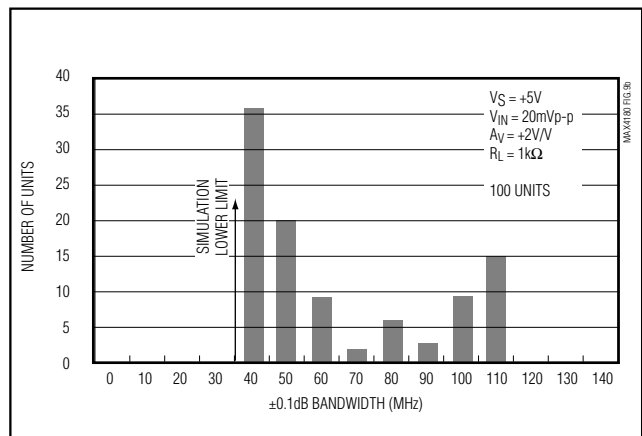

Figure 9b. MAX4180 ± 0.1 dB Bandwidth Distribution (Single Supply)

Single/Dual/Quad, 270MHz, 1mA, SOT23, Current-Feedback Amplifiers with Shutdown

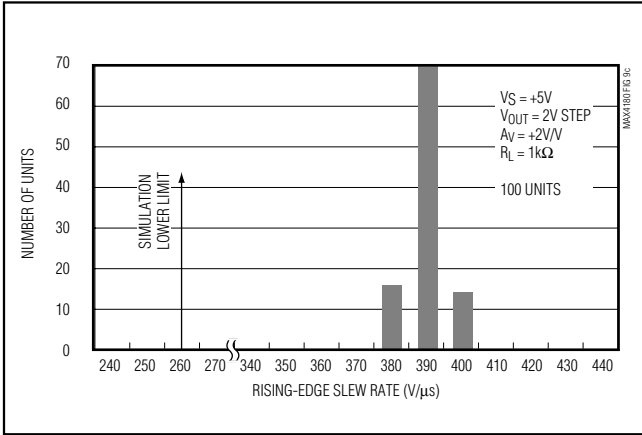

Figure 9c. MAX4180 Rising-Edge Slew-Rate Distribution (Single Supply)

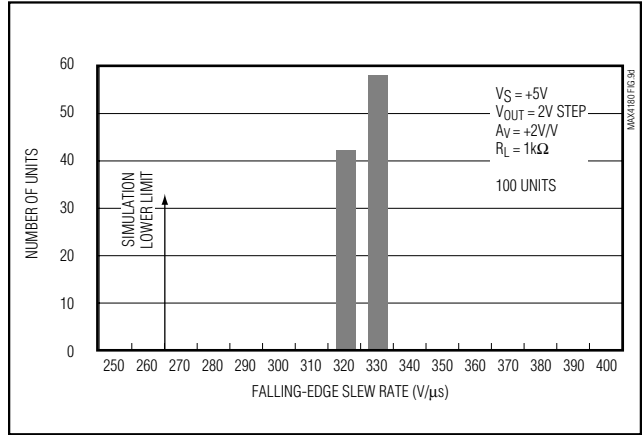

Figure 9d. MAX4180 Falling-Edge Slew-Rate Distribution (Single Supply)

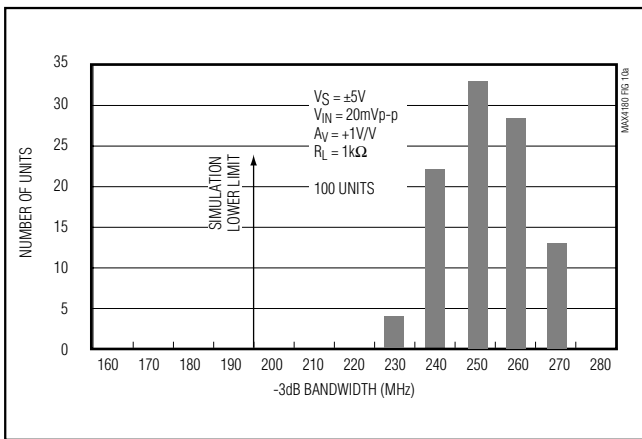

Figure 10a. MAX4181 -3dB Bandwidth Distribution (Dual Supplies)

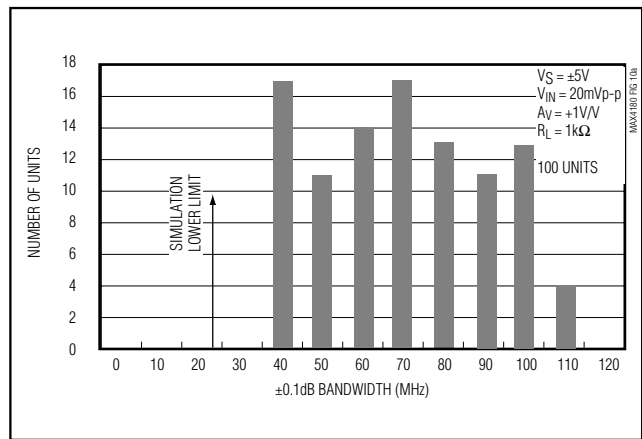

Figure 10b. MAX4181 ±0.1dB Bandwidth Distribution (Dual Supplies)

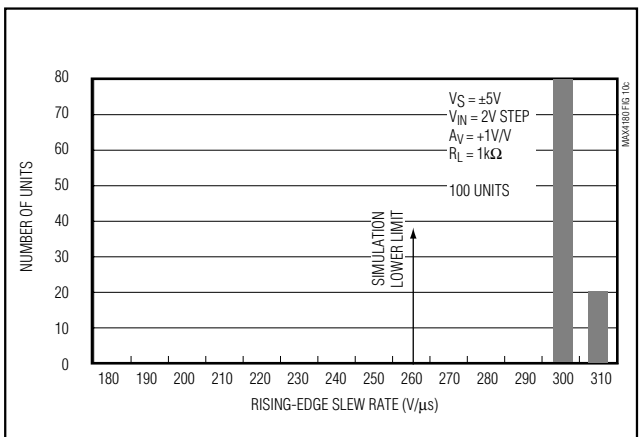

Figure 10c. MAX4181 Rising-Edge Slew-Rate Distribution (Dual Supplies)

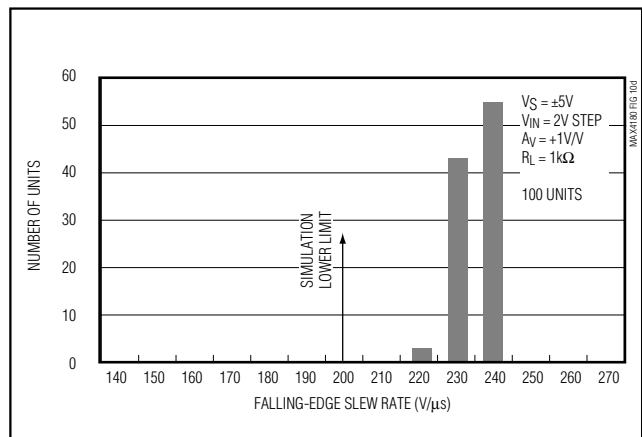

Figure 10d. MAX4181 Falling-Edge Slew-Rate Distribution (Dual Supplies)

Single/Dual/Quad, 270MHz, 1mA, SOT23, Current-Feedback Amplifiers with Shutdown

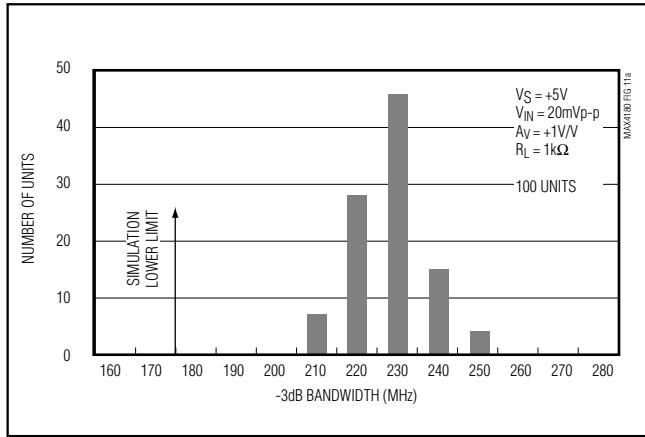

Figure 11a. MAX4181 -3dB Bandwidth Distribution (Single Supply)

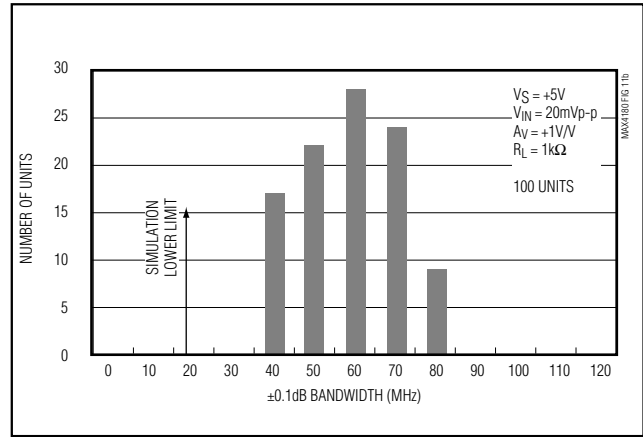

Figure 11b. MAX4181 ±0.1dB Bandwidth Distribution (Single Supply)

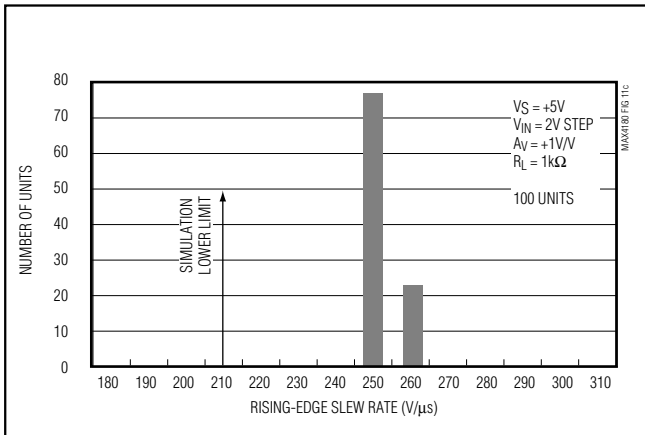

Figure 11c. MAX4181 Rising-Edge Slew-Rate Distribution (Single Supply)

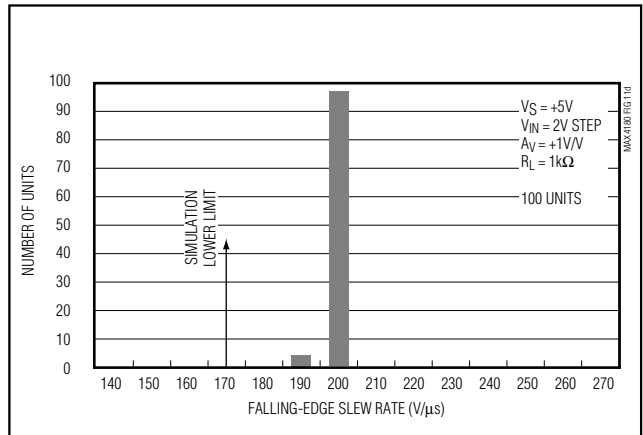

Figure 11d. MAX4181 Falling-Edge Slew-Rate Distribution (Single Supply)

Single/Dual/Quad, 270MHz, 1mA, SOT23, Current-Feedback Amplifiers with Shutdown

Pin Configurations (continued)

MAX4180-MAX4187

TOP VIEW

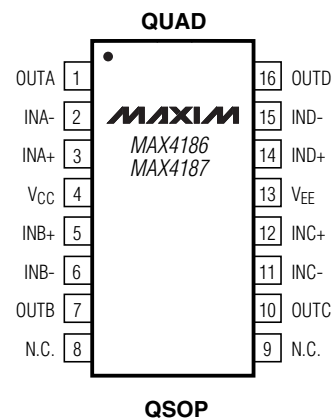
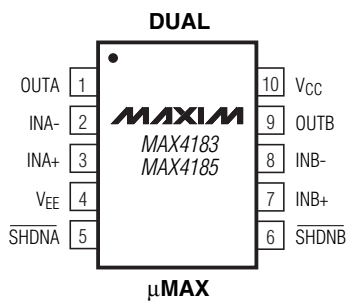
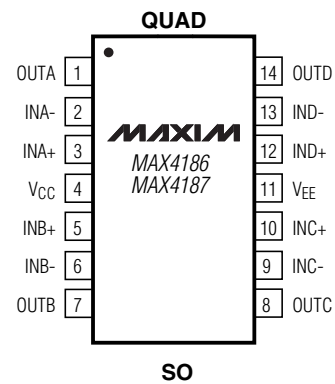
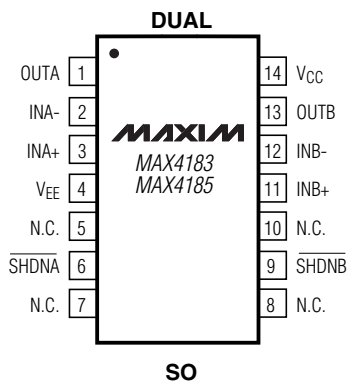
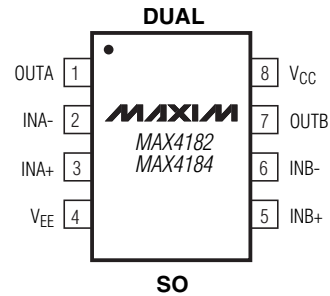
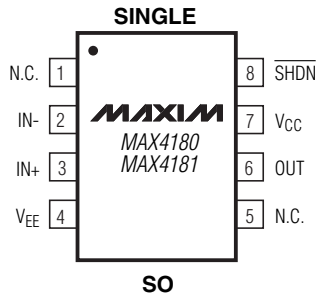

Single/Dual/Quad, 270MHz, 1mA, SOT23, Current-Feedback Amplifiers with Shutdown

Ordering Information (continued)

| PART | TEMP RANGE | PIN-PACKAGE | TOP MARK |
|--------------|----------------|---------------|----------|
| MAX4181EUT-T | -40°C to +85°C | 6 SOT23-6 | AAAC |
| MAX4181ESA | -40°C to +85°C | 8 SO | — |
| MAX4182ESA | -40°C to +85°C | 8 SO | — |
| MAX4183EUB | -40°C to +85°C | 10 μ MAX* | — |
| MAX4183ESD | -40°C to +85°C | 14 SO | — |
| MAX4184ESA | -40°C to +85°C | 8 SO | — |
| MAX4185EUB | -40°C to +85°C | 10 μ MAX* | — |
| MAX4185ESD | -40°C to +85°C | 14 SO | — |
| MAX4186ESD | -40°C to +85°C | 14 SO | — |
| MAX4186EEE | -40°C to +85°C | 16 QSOP | — |
| MAX4187ESD | -40°C to +85°C | 14 SO | — |
| MAX4187EEE | -40°C to +85°C | 16 QSOP | — |

*Contact factory for availability.

Chip Information

MAX4180/MAX4181 TRANSISTOR COUNT: 83
SUBSTRATE CONNECTED TO V_{EE}

MAX4182-MAX4185 TRANSISTOR COUNT: 166
SUBSTRATE CONNECTED TO V_{EE}

MAX4186/MAX4187 TRANSISTOR COUNT: 235
SUBSTRATE CONNECTED TO V_{EE}

Package Information

| SYMBOL | MIN | MAX |
|--------|----------|------|
| A | 0.90 | 1.45 |
| A1 | 0.00 | 0.15 |
| A2 | 0.90 | 1.30 |
| b | 0.35 | 0.50 |
| C | 0.08 | 0.20 |
| D | 2.80 | 3.00 |
| E | 2.60 | 3.00 |
| E1 | 1.50 | 1.75 |
| L | 0.35 | 0.55 |
| e | 0.95 REF | |
| a | 0° | 10° |

NOTES:
 1. ALL DIMENSIONS ARE IN MILLIMETERS.
 2. FOOT LENGTH MEASURED AT INTERCEPT POINT BETWEEN DATUM A & LEAD SURFACE.
 3. PACKAGE OUTLINE EXCLUSIVE OF MOLD FLASH & METAL BURR.
 4. PACKAGE OUTLINE INCLUSIVE OF SOLDER PLATING.
 5. PIN 1 IS LOWER LEFT PIN WHEN READING TOP MARK FROM LEFT TO RIGHT. (SEE EXAMPLE TOP MARK)
 6. PIN 1 I.D. DOT IS 0.3 MM ϕ MIN. LOCATED ABOVE PIN 1.
 7. MEETS JEDEC MO178.

6LSOT23

| | | |
|--------------------------------------|---------------------------------|--------------|
| MAXIM | | |
| PROPRIETARY INFORMATION | | |
| TITLE PACKAGE OUTLINE, SOT-23, 6L | | |
| APPROVAL | DOCUMENT CONTROL NO. 21-0058 | REV E 1/1 |

Maxim cannot assume responsibility for use of any circuitry other than circuitry entirely embodied in a Maxim product. No circuit patent licenses are implied. Maxim reserves the right to change the circuitry and specifications without notice at any time.

24 **Maxim Integrated Products, 120 San Gabriel Drive, Sunnyvale, CA 94086 408-737-7600**

Mouser Electronics

Authorized Distributor

Click to View Pricing, Inventory, Delivery & Lifecycle Information:

[Maxim Integrated:](#)

[MAX4183EUB+](#) [MAX4183EUB+T](#)