

# Contents

- 1      Block diagrams and pins descriptions ..... 6**
- 2      Electrical specifications ..... 8**
  - 2.1    Thermal data ..... 8
  - 2.2    Absolute maximum ratings ..... 8
  - 2.3    Electrical characteristics for dual high side switch ..... 9
  - 2.4    Electrical characteristics for low side switches .....11
  - 2.5    Dual high-side switch timing data ..... 13
  - 2.6    Electrical characterization for dual high-side switch ..... 16
  - 2.7    Electrical characterization for low-side switches ..... 19
- 3      Application recommendations ..... 23**
- 4      Thermal data ..... 26**
  - 4.1    SO-28 thermal data ..... 26
  - 4.2    Thermal calculation in clockwise and anti-clockwise operation in steady state mode ..... 27
    - 4.2.1    Thermal resistances definition ..... 27
    - 4.2.2    Thermal calculation in transient mode ..... 27
    - 4.2.3    Single pulse thermal impedance definition ..... 27
    - 4.2.4    Pulse calculation formula ..... 27
- 5      Package information ..... 30**
  - 5.1    SO-28 package information ..... 30
  - 5.2    SO-28 Packing information ..... 32
- 6      Revision history ..... 33**

## List of tables

Table 1.	Device summary . . . . .	1
Table 2.	Pin definition and function. . . . .	7
Table 3.	Thermal data . . . . .	8
Table 4.	Dual high-side switch . . . . .	8
Table 5.	Low-side switch . . . . .	8
Table 6.	Power outputs (for each channel). . . . .	9
Table 7.	Switching (for each channel) ( $V_{CC} = 13V$ ) . . . . .	10
Table 8.	Logic input (for each channel) . . . . .	10
Table 9.	Status pin (for each channel) . . . . .	10
Table 10.	Protections (for each channel) . . . . .	10
Table 11.	Open-load detection (for each channel) . . . . .	11
Table 12.	Off-state . . . . .	11
Table 13.	On-state . . . . .	12
Table 14.	Dynamic . . . . .	12
Table 15.	Switching . . . . .	12
Table 16.	Source drain diode . . . . .	12
Table 17.	Protections . . . . .	13
Table 18.	Truth table. . . . .	14
Table 19.	Thermal calculation in clockwise and anti-clockwise operation in steady state mode . . . . .	27
Table 20.	Thermal parameters . . . . .	29
Table 21.	SO-28 mechanical data . . . . .	31
Table 22.	Document revision history . . . . .	33

## List of figures

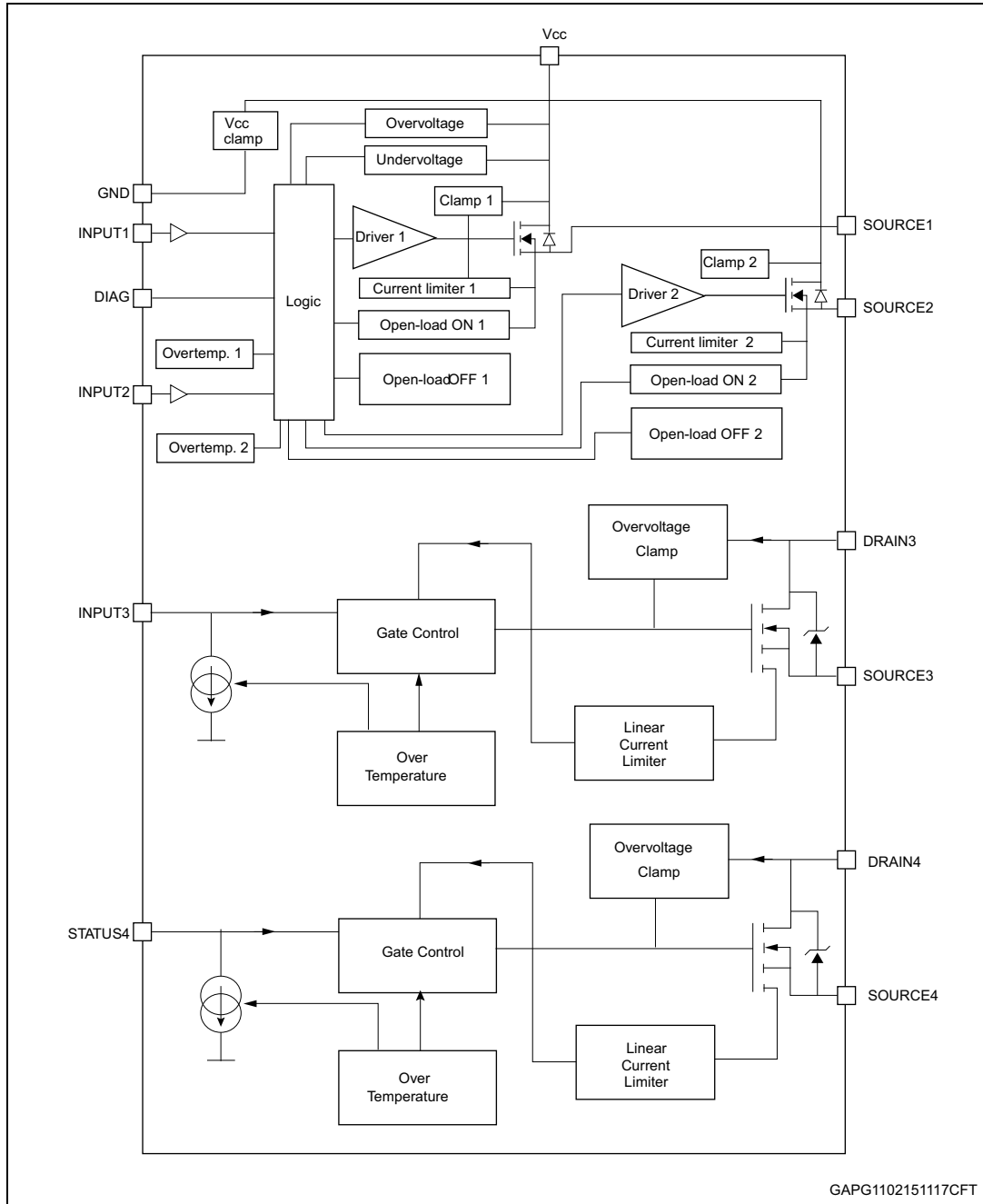
Figure 1.	Block diagram . . . . .	6
Figure 2.	Connection diagram . . . . .	7
Figure 3.	Switching time waveforms . . . . .	13
Figure 4.	Open-load status timing (with external pull-up) . . . . .	14
Figure 5.	Overtemperature status timing . . . . .	15
Figure 6.	Off-state output current . . . . .	16
Figure 7.	Input clamp voltage . . . . .	16
Figure 8.	High level input current . . . . .	16
Figure 9.	Input high level voltage . . . . .	16
Figure 10.	Input low level voltage . . . . .	16
Figure 11.	Input hysteresis voltage . . . . .	16
Figure 12.	Overvoltage shutdown . . . . .	17
Figure 13.	$I_{LIM}$ vs $T_{case}$ . . . . .	17
Figure 14.	Turn-on voltage slope . . . . .	17
Figure 15.	Turn-off voltage slope . . . . .	17
Figure 16.	On-state resistance vs $T_{case}$ . . . . .	17
Figure 17.	On-state resistance vs $V_{CC}$ . . . . .	17
Figure 18.	Status leakage current . . . . .	18
Figure 19.	Status low output voltage . . . . .	18
Figure 20.	Open-load on-state detection threshold . . . . .	18
Figure 21.	Open-load off-state voltage detection threshold . . . . .	18
Figure 22.	Status clamp voltage . . . . .	18
Figure 23.	Static drain source on resistance . . . . .	19
Figure 24.	Derating curve . . . . .	19
Figure 25.	Transconductance . . . . .	19
Figure 26.	Transfer characteristics . . . . .	19
Figure 27.	Turn-on current slope ( $V_{IN} = 5$ V) . . . . .	19
Figure 28.	Turn-on current slope ( $V_{IN} = 3.5$ V) . . . . .	19
Figure 29.	Input voltage vs input charge . . . . .	20
Figure 30.	Capacitance variations . . . . .	20
Figure 31.	Switching time resistive load ( $V_{IN} = 5$ V) . . . . .	20
Figure 32.	Switching time resistive load ( $R_G = 10$ $\Omega$ ) . . . . .	20
Figure 33.	Output characteristics . . . . .	20
Figure 34.	Step response current limit . . . . .	20
Figure 35.	Source drain diode forward characteristics . . . . .	21
Figure 36.	Static drain source on resistance vs $I_{DV}$ . . . . .	21
Figure 37.	Static drain source on resistance vs input voltage ( $I_D = 7$ A) . . . . .	21
Figure 38.	Static drain source on resistance vs input voltage . . . . .	21
Figure 39.	Normalized input threshold voltage vs temperature . . . . .	21
Figure 40.	Normalized on resistance vs temperature . . . . .	21
Figure 41.	Turn-off drain source voltage slope ( $V_{IN} = 3.5$ V) . . . . .	22
Figure 42.	Turn-off drain source voltage slope ( $V_{IN} = 5$ V) . . . . .	22
Figure 43.	Current limit vs junction temperature . . . . .	22
Figure 44.	Application diagram bridge drivers . . . . .	23
Figure 45.	Recommended motor operation . . . . .	24
Figure 46.	Waveforms . . . . .	25
Figure 47.	SO-28 PC board . . . . .	26
Figure 48.	Chipset configuration . . . . .	26

---

Figure 49.	Auto and mutual $R_{thj-amb}$ vs PCB copper area in open box free air condition . . . . .	26
Figure 50.	SO-28 HSD thermal impedance junction ambient single pulse . . . . .	28
Figure 51.	SO-28 LSD thermal impedance junction ambient single pulse. . . . .	28
Figure 52.	Thermal fitting model of an H-bridge in SO-28 . . . . .	29
Figure 53.	SO-28 package outline . . . . .	30
Figure 54.	Tube dimensions (no suffix) . . . . .	32
Figure 55.	Tape and reel dimensions (suffix "13TR") . . . . .	32

# 1 Block diagrams and pins descriptions

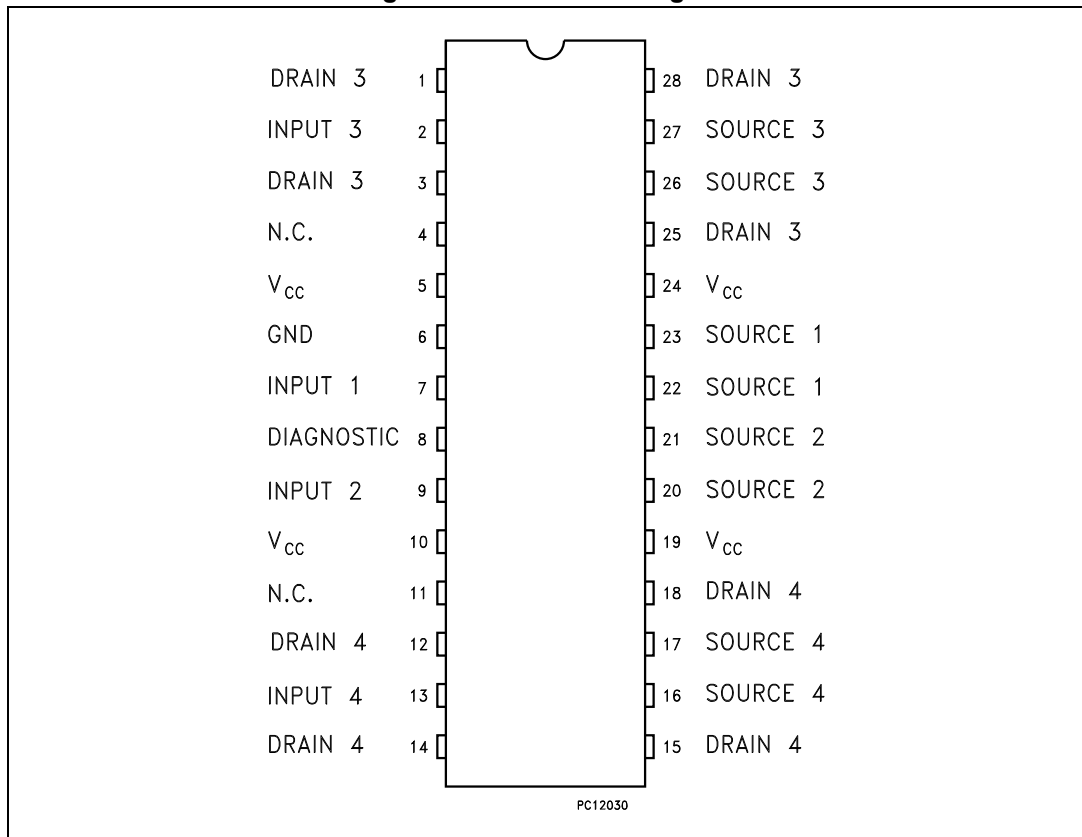
Figure 1. Block diagram



**Table 2. Pin definition and function**

No	Name	Function
1, 3, 25, 28	DRAIN 3	Drain of switch 3 (low-side switch)
2	INPUT 3	Input of switch 3 (low-side switch)
4, 11	N.C.	Not connected
5, 10, 19, 24	V <sub>CC</sub>	Drain of switches 1 and 2 (high-side switches) and power supply voltage
6	GND	Ground of switches 1 and 2 (high-side switches)
7	INPUT 1	Input of switch 1 (high-side switches)
8	DIAGNOSTIC	Diagnostic of switches 1 and 2 (high-side switches)
9	INPUT 2	Input of switch 2 (high-side switch)
12, 14, 15, 18	DRAIN 4	Drain of switch 4 (low-side switch)
13	INPUT 4	Input of switch 4 (low-side switch)
16, 17	SOURCE 4	Source of switch 4 (low-side switch)
20, 21	SOURCE 2	Source of switch 2 (high-side switch)
22, 23	SOURCE 1	Source of switch 1 (high-side switch)
26, 27	SOURCE 3	Source of switch 3 (low-side switch)

**Figure 2. Connection diagram**



## 2 Electrical specifications

### 2.1 Thermal data

Table 3. Thermal data

Symbol	Parameter	Value max (°C/W)
R <sub>thj-case</sub>	Thermal resistance junction-case (high side switch)	20
R <sub>thj-case</sub>	Thermal resistance junction-case (low side switch)	20
R <sub>thj-amb</sub>	Thermal resistance junction-ambient (with 6 cm <sup>2</sup> of Cu heat sink)	See <a href="#">Figure 49</a>

### 2.2 Absolute maximum ratings

Table 4. Dual high-side switch

Symbol	Parameter	Value	Unit
V <sub>CC</sub>	DC supply voltage	41	V
-V <sub>CC</sub>	Reverse DC supply voltage	-0.3	V
-I <sub>GND</sub>	DC reverse ground pin current	-200	mA
I <sub>OUT</sub>	DC output current	Internally limited	A
-I <sub>OUT</sub>	Reverse DC output current	-6	A
I <sub>IN</sub>	DC input current	±10	mA
I <sub>STAT</sub>	DC status current	±10	mA
V <sub>ESD</sub>	Electrostatic discharge (human body model: R = 1.5 kΩ; C = 100 pF)		
	– Input	4000	V
	– Status	4000	V
	– Output	5000	V
	– V <sub>CC</sub>	5000	V
P <sub>tot</sub>	Power dissipation (T <sub>c</sub> = 25 °C)	6	W
T <sub>j</sub>	Junction operating temperature	Internally limited	°C
T <sub>c</sub>	Case operating temperature	-40 to 150	°C
T <sub>stg</sub>	Storage temperature	-55 to 150	°C

Table 5. Low-side switch

Symbol	Parameter	Value	Unit
V <sub>DS</sub>	Drain source voltage (V <sub>IN</sub> = 0 V)	Internally clamped	V
V <sub>IN</sub>	Input voltage	Internally clamped	V
I <sub>IN</sub>	Input current	±20	mA

Table 5. Low-side switch (continued)

Symbol	Parameter	Value	Unit
$R_{IN\ MIN}$	Minimum input series impedance	10	$\Omega$
$I_D$	Drain current	Internally limited	A
$I_R$	Reverse DC output current	-15	A
$V_{ESD1}$	Electrostatic discharge (R = 1.5 K $\Omega$ , C = 100 pF)	4000	V
$V_{ESD2}$	Electrostatic discharge on output pin only (human body model: R = 330 $\Omega$ , C = 150 pF)	5000	V
$P_{tot}$	Power dissipation (T <sub>c</sub> = 25 °C)	6	W
$T_j$	Operating junction temperature	Internally limited	°C
$T_c$	Case operating temperature	Internally limited	°C
$T_{stg}$	Storage temperature	-55 to 150	°C

## 2.3 Electrical characteristics for dual high side switch

8 V < V<sub>CC</sub> < 36 V; -40 °C < T<sub>j</sub> < 150 °C, unless otherwise specified.

Table 6. Power outputs (for each channel)

Symbol	Parameter	Test conditions	Min	Typ	Max	Unit
$V_{CC}^{(1)}$	Operating supply voltage		5.5	13	36	V
$V_{USD}^{(1)}$	Undervoltage shutdown		3	4	5.5	V
$V_{OV}^{(1)}$	Overvoltage shutdown		36			V
$R_{ON}$	On-state resistance	$I_{OUT} = 2\ A; T_j = 25\ ^\circ C$			60	m $\Omega$
		$I_{OUT} = 2\ A; V_{CC} > 8\ V$			120	m $\Omega$
$I_S^{(1)}$	Supply current	Off-state; V <sub>CC</sub> = 13 V; V <sub>IN</sub> = V <sub>OUT</sub> = 0 V		12	40	$\mu A$
		Off-state; V <sub>CC</sub> = 13V; V <sub>IN</sub> = V <sub>OUT</sub> = 0 V; T <sub>j</sub> = 25 °C		12	25	$\mu A$
		On-state; V <sub>CC</sub> = 13 V		5	7	mA
$I_{L(off1)}$	Off-state output current	V <sub>IN</sub> = V <sub>OUT</sub> = 0 V; V <sub>CC</sub> = 36 V; T <sub>j</sub> = 125 °C	0		50	$\mu A$
$I_{L(off2)}$	Off-state output current	V <sub>IN</sub> = 0 V; V <sub>OUT</sub> = 3.5 V	-75		0	$\mu A$
$I_{L(off3)}$	Off-state output current	V <sub>IN</sub> = V <sub>OUT</sub> = 0 V; V <sub>CC</sub> = 13 V; T <sub>j</sub> = 125 °C			5	$\mu A$
$I_{L(off4)}$	Off-state output current	V <sub>IN</sub> = V <sub>OUT</sub> = 0 V; V <sub>CC</sub> = 13 V; T <sub>j</sub> = 25 °C			3	$\mu A$

1. For device.



Table 7. Switching (for each channel) ( $V_{CC} = 13V$ )

Symbol	Parameter	Test conditions	Min	Typ	Max	Unit
$t_{d(on)}$	Turn-on delay time	$R_L = 6.5 \Omega$ from $V_{IN}$ rising edge to $V_{OUT} = 1.3 V$	—	30	—	$\mu s$
$t_{d(off)}$	Turn-off delay time	$R_L = 6.5 \Omega$ from $V_{IN}$ falling edge to $V_{OUT} = 11.7 V$	—	30	—	$\mu s$
$dV_{OUT}/dt_{(on)}$	Turn-on voltage slope	$R_L = 6.5 \Omega$ from $V_{OUT} = 1.3 V$ to $V_{OUT} = 10.4 V$	—	(1)	—	$V/\mu s$
$dV_{OUT}/dt_{(off)}$	Turn-off voltage slope	$R_L = 6.5 \Omega$ from $V_{OUT} = 11.7 V$ to $V_{OUT} = 1.3 V$	—	(1)	—	$V/\mu s$

1. See relative diagram.

Table 8. Logic input (for each channel)

Symbol	Parameter	Test conditions	Min	Typ	Max	Unit
$V_{IL}$	Input low level				1.25	V
$I_{IL}$	Low level input current	$V_{IN} = 1.25 V$	1			$\mu A$
$V_{IH}$	Input high level		3.25			V
$I_{IH}$	High level input current	$V_{IN} = 3.25 V$			10	$\mu A$
$V_{I(hyst)}$	Input hysteresis voltage		0.5			V
$V_{ICL}$	Input clamp voltage	$I_{IN} = 1 mA$	6	6.8	8	V
		$I_{IN} = -1 mA$		-0.7		V

Table 9. Status pin (for each channel)

Symbol	Parameter	Test conditions	Min	Typ	Max	Unit
$V_{STAT}$	Status low output voltage	$I_{STAT} = 1.6 mA$			0.5	V
$I_{LSTAT}$	Status leakage current	Normal operation; $V_{STAT} = 5 V$			10	$\mu A$
$C_{STAT}$	Status pin input capacitance	Normal operation; $V_{STAT} = 5 V$			100	pF
$V_{SCL}$	Status clamp voltage	$I_{STAT} = 1 mA$	6	6.8	8	V
		$I_{STAT} = -1 mA$		-0.7		V

Table 10. Protections (for each channel)

Symbol	Parameter	Test conditions	Min	Typ	Max	Unit
$T_{TSD}$	Shutdown temperature		150	175	200	$^{\circ}C$
$T_R$	Reset temperature		135			$^{\circ}C$
$T_{hyst}$	Thermal hysteresis		7	15		$^{\circ}C$
$t_{SDL}$	Status delay in overload conditions	$T_j > T_{TSD}$			20	$\mu s$

Table 10. Protections (for each channel) (continued)

Symbol	Parameter	Test conditions	Min	Typ	Max	Unit
$I_{lim}$	Current limitation		6	9	15	A
		$T_j = 125\text{ }^\circ\text{C}$	8.5		15	A
		$5.5\text{ V} < V_{CC} < 36\text{ V}$			15	A
$V_{demag}$	Turn-off output clamp voltage	$I_{OUT} = 2\text{ A}; L = 6\text{ mH}$	$V_{CC}-41$	$V_{CC}-48$	$V_{CC}-55$	V

Note: To ensure long term reliability under heavy overload or short circuit conditions, protection and related diagnostic signals must be used together with a proper software strategy. If the device is subjected to abnormal conditions, this software must limit the duration and number of activation cycles.

Table 11. Open-load detection (for each channel)

Symbol	Parameter	Test conditions	Min	Typ	Max	Unit
$I_{OL}$	Open-load on-state detection threshold	$V_{IN} = 5\text{ V}$	50	100	200	mA
$t_{DOL(on)}$	Open-load on-state detection delay	$I_{OUT} = 0\text{ A}$			200	$\mu\text{s}$
$V_{OL}$	Open-load off-state voltage detection threshold	$V_{IN} = 0\text{ V}$	1.5	2.5	3.5	V
$t_{DOL(off)}$	Open-load detection delay at turn-off				1000	$\mu\text{s}$

## 2.4 Electrical characteristics for low side switches

$-40\text{ }^\circ\text{C} < T_j < 150\text{ }^\circ\text{C}$ , unless otherwise specified.

Table 12. Off-state

Symbol	Parameter	Test conditions	Min	Typ	Max	Unit
$V_{CLAMP}$	Drain source clamp voltage	$V_{IN} = 0\text{ V}; I_D = 7\text{ A}$	40	45	55	V
$V_{CLTH}$	Drain source clamp threshold voltage	$V_{IN} = 0\text{ V}; I_D = 2\text{ mA}$	36			V
$V_{INTH}$	Input threshold voltage	$V_{DS} = V_{IN}; I_D = 1\text{ mA}$	0.5		2.5	V
$I_{ISS}$	Supply current from input pin	$V_{DS} = 0\text{ V}; V_{IN} = 5\text{ V}$		100	150	$\mu\text{A}$
$V_{INCL}$	Input-source clamp voltage	$I_{IN} = 1\text{ mA}$	6	6.8	8	V
		$I_{IN} = -1\text{ mA}$	-1.0		-0.3	V
$I_{DSS}$	Zero input voltage drain current ( $V_{IN} = 0\text{ V}$ )	$V_{DS} = 13\text{ V}; V_{IN} = 0\text{ V}; T_j = 25\text{ }^\circ\text{C}$			30	$\mu\text{A}$
		$V_{DS} = 25\text{ V}; V_{IN} = 0\text{ V}$			75	$\mu\text{A}$

Table 13. On-state

Symbol	Parameter	Test conditions	Min	Typ	Max	Unit
$R_{DS(on)}$	Static drain source on resistance	$V_{IN} = 5\text{ V}; I_D = 7\text{ A}; T_j = 25\text{ }^\circ\text{C}$	—	—	35	m $\Omega$
		$V_{IN} = 5\text{ V}; I_D = 7\text{ A}$	—	—	70	m $\Omega$

$T_j = 25^\circ\text{C}$ , unless otherwise specified.

Table 14. Dynamic

Symbol	Parameter	Test conditions	Min	Typ	Max	Unit
$g_{fs}^{(1)}$	Forward trans conductance	$V_{DD} = 13\text{ V}; I_D = 7\text{ A}$	—	18	—	S
$C_{OSS}$	Output capacitance	$V_{DS} = 13\text{ V}; f = 1\text{ MHz}; V_{IN} = 0\text{ V}$	—	400	—	pF

1. Pulsed: Pulse duration = 300  $\mu\text{s}$ , duty cycle 1.5 %.

Table 15. Switching

Symbol	Parameter	Test conditions	Min	Typ	Max	Unit
$t_{d(on)}$	Turn-on delay time	$V_{DD} = 15\text{ V}; I_D = 7\text{ A}; V_{gen} = 5\text{ V}; R_{gen} = R_{IN\text{ MIN}} = 10\text{ }\Omega$	—	80	250	ns
$t_r$	Rise time		—	350	1000	ns
$t_{d(off)}$	Turn-off delay time		—	450	1350	ns
$t_f$	Fall time		—	150	500	ns
$t_{d(on)}$	Turn-on delay time	$V_{DD} = 15\text{ V}; I_D = 7\text{ A}; V_{gen} = 5\text{ V}; R_{gen} = 2.2\text{ k}\Omega$	—	1.5	4.5	$\mu\text{s}$
$t_r$	Rise time		—	9.7	30	$\mu\text{s}$
$t_{d(off)}$	Turn-off delay time		—	9	25	$\mu\text{s}$
$t_f$	Fall time		—	10.2	30	$\mu\text{s}$
$(di/dt)_{on}$	Turn-on current slope	$V_{DD} = 15\text{ V}; I_D = 7\text{ A}; V_{gen} = 5\text{ V}; R_{gen} = R_{IN\text{ MIN}} = 10\text{ }\Omega$	—	16		A/ $\mu\text{s}$
$Q_i$	Total input charge	$V_{DD} = 12\text{ V}; I_D = 7\text{ A}; V_{IN} = 5\text{ V}; I_{gen} = 2.13\text{ mA}$	—	36.8		nC

Table 16. Source drain diode

Symbol	Parameter	Test conditions	Min	Typ	Max	Unit
$V_{SD}^{(1)}$	Forward on voltage	$I_{SD} = 7\text{ A}; V_{IN} = 0\text{ V}$	—	0.8	—	V
$t_{rr}$	Reverse recovery time	$I_{SD} = 7\text{ A}; di/dt = 40\text{ A}/\mu\text{s}; V_{DD} = 30\text{ V}; L = 200\text{ }\mu\text{H}$	—	300	—	ns
$Q_{rr}$	Reverse recovery charge		—	0.80	—	$\mu\text{C}$
$I_{RRM}$	Reverse recovery current		—	5	—	A

1. Pulsed: Pulse duration = 300  $\mu\text{s}$ , duty cycle 1.5%.

-40 °C < T<sub>j</sub> < 150 °C, unless otherwise specified.

**Table 17. Protections**

Symbol	Parameter	Test conditions	Min	Typ	Max	Unit
I <sub>lim</sub>	Drain current limit	V <sub>IN</sub> = 5 V; V <sub>DS</sub> = 13 V	12	18	24	A
		V <sub>IN</sub> = 5 V; V <sub>DS</sub> = 13 V; T <sub>j</sub> = 125 °C	15		24	A
t <sub>dlim</sub>	Step response current limit	V <sub>IN</sub> = 5 V; V <sub>DS</sub> = 13 V		45		µs
T <sub>jsh</sub>	Overtemperature shutdown		150	175		°C
T <sub>jrs</sub>	Overtemperature reset		135			°C
I <sub>gf</sub>	Fault sink current	V <sub>IN</sub> = 5 V; V <sub>DS</sub> = 13 V; T <sub>j</sub> = T <sub>jsh</sub>	10	15	20	mA
E <sub>as</sub>	Single pulse avalanche energy	starting T <sub>j</sub> = 25 °C; V <sub>DD</sub> = 24 V V <sub>IN</sub> = 5 V; R <sub>gen</sub> = R <sub>IN MIN</sub> = 10 Ω; L = 24 mH	400			mJ

## 2.5 Dual high-side switch timing data

**Figure 3. Switching time waveforms**

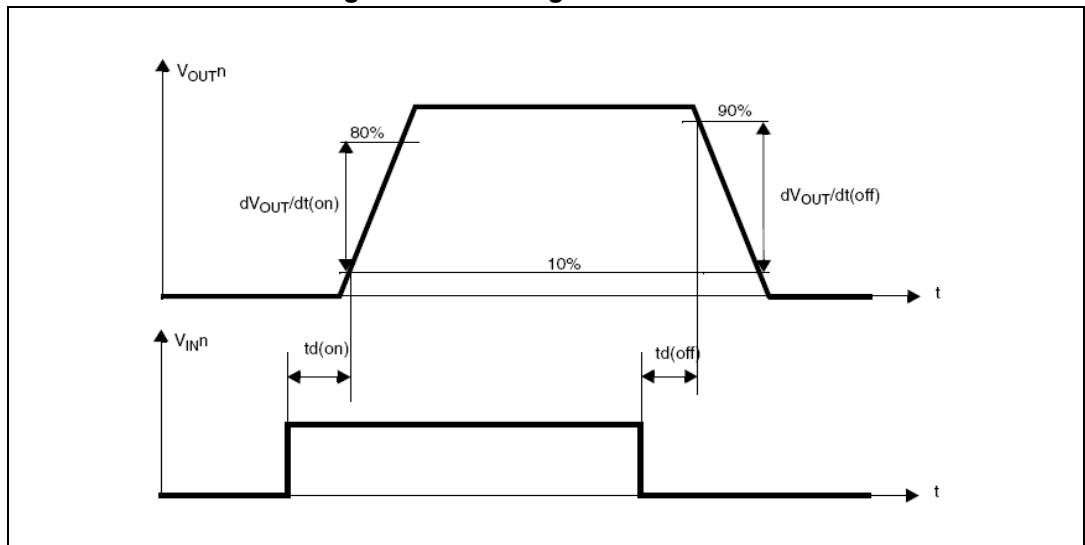


Table 18. Truth table

Conditions	Input	Output	Status
Normal operation	L	L	H
	H	H	H
Current limitation	L	L	H
	H	X	( $T_j < T_{TSD}$ ) H ( $T_j > T_{TSD}$ ) L
Over temperature	L	L	H
	H	L	L
Undervoltage	L	L	X
	H	L	X
Overvoltage	L	L	H
	H	L	H
Output voltage $> V_{OL}$	L	H	L
	H	H	H
Output current $< I_{OL}$	L	L	H
	H	H	L

Figure 4. Open-load status timing (with external pull-up)

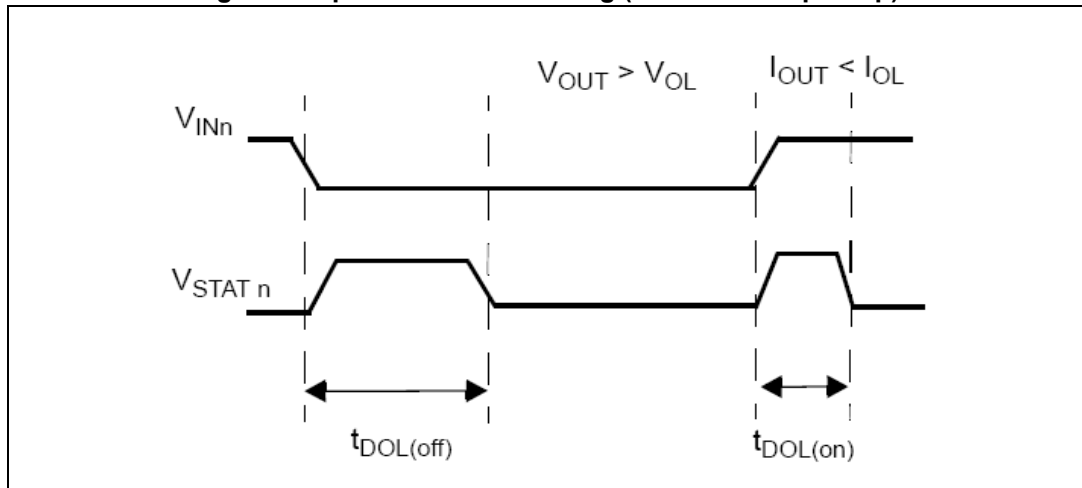
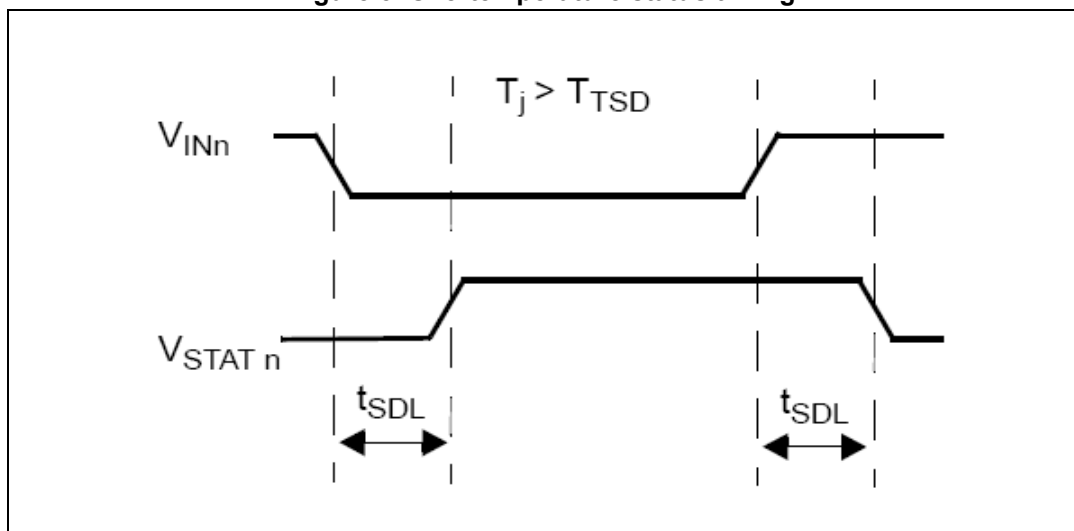
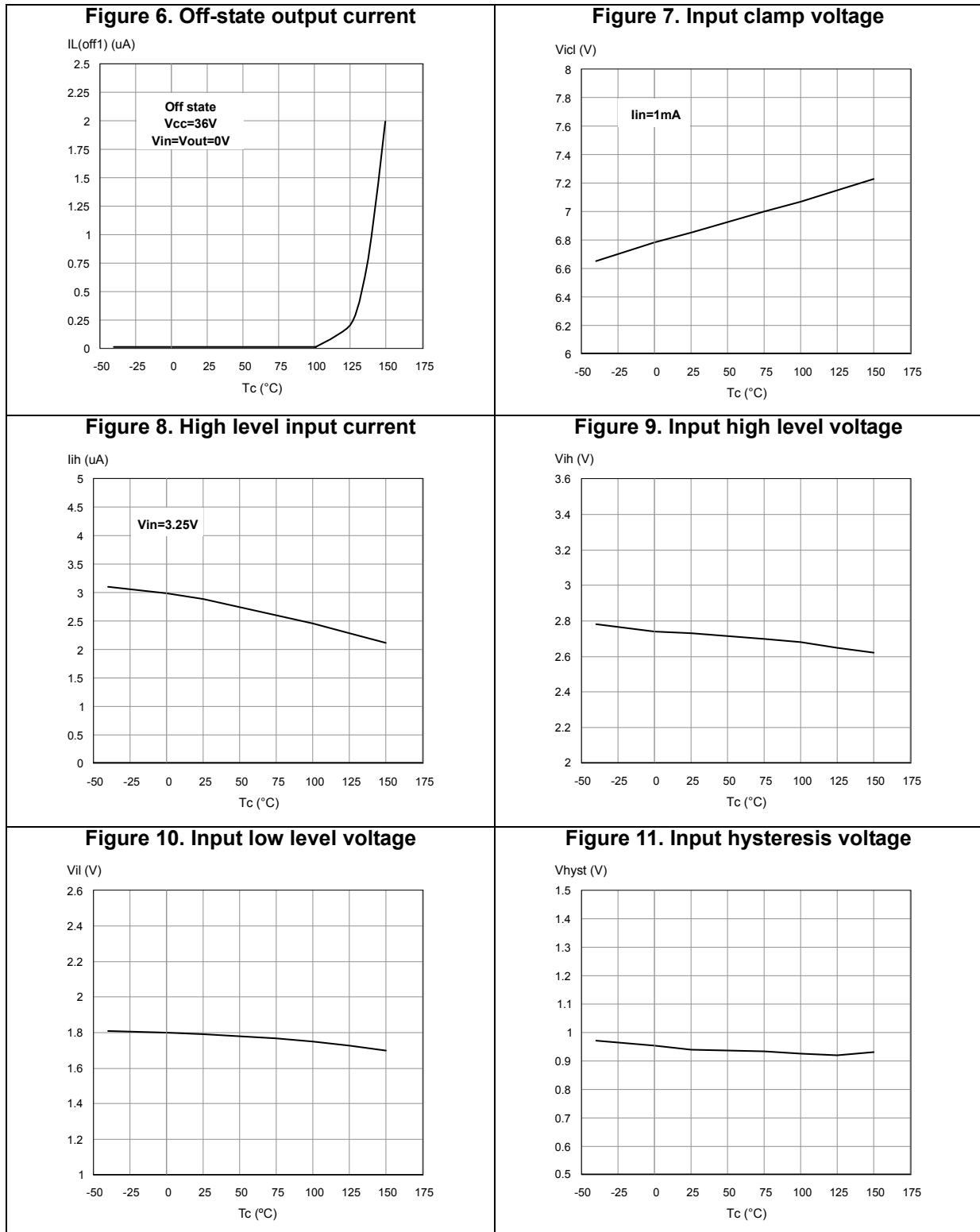
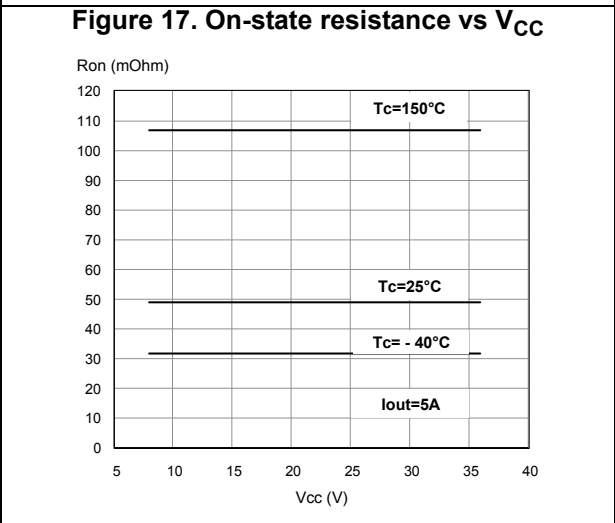
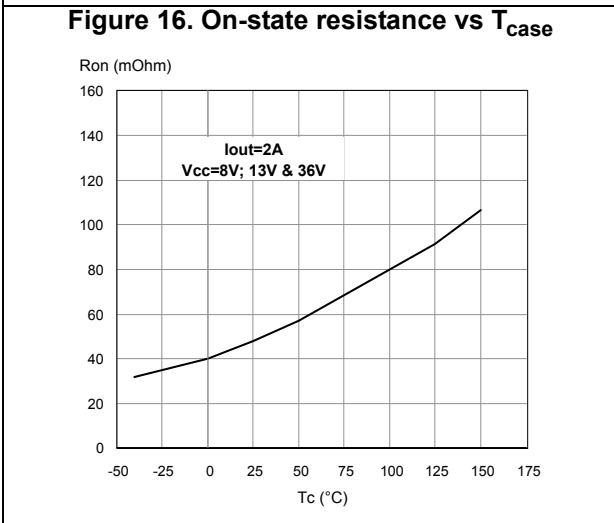
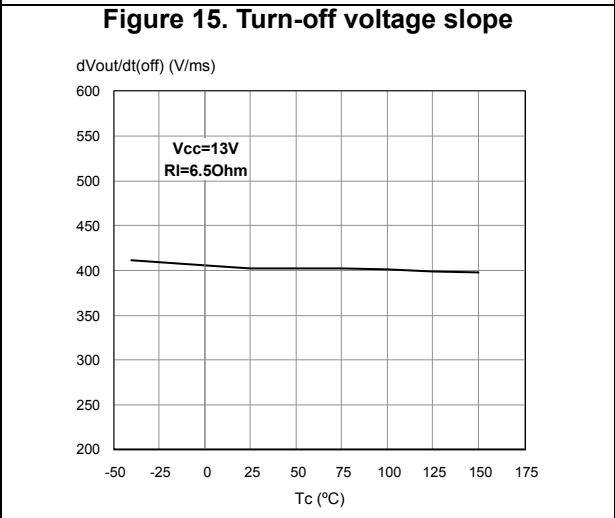
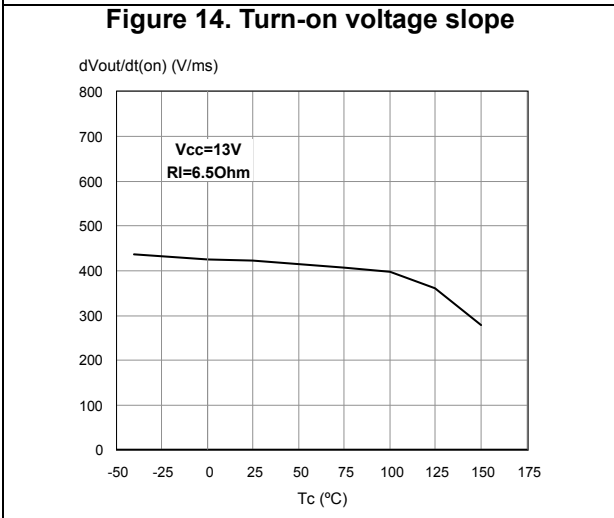
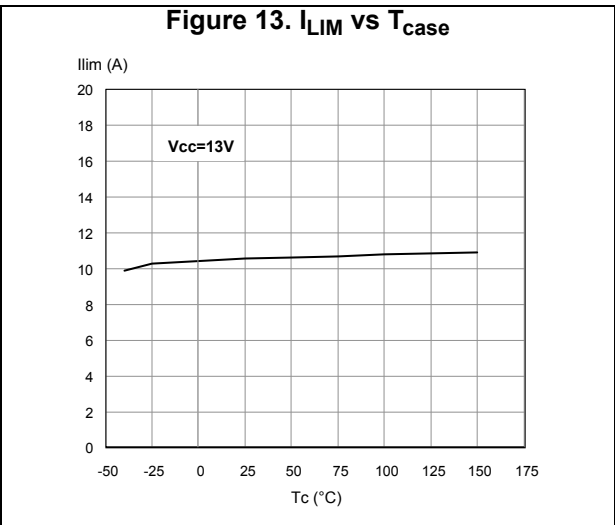
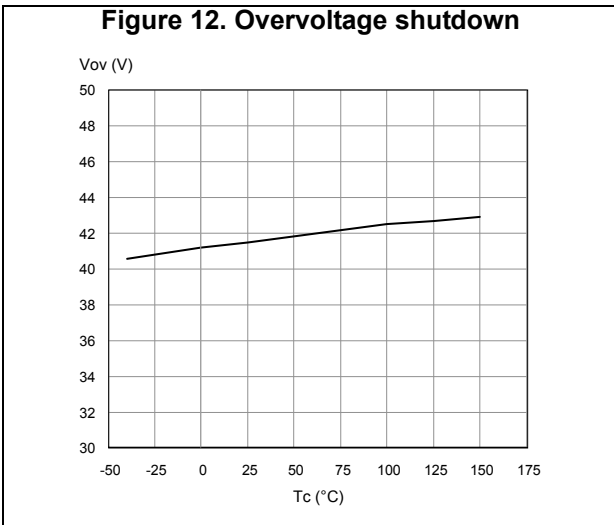


Figure 5. Overtemperature status timing



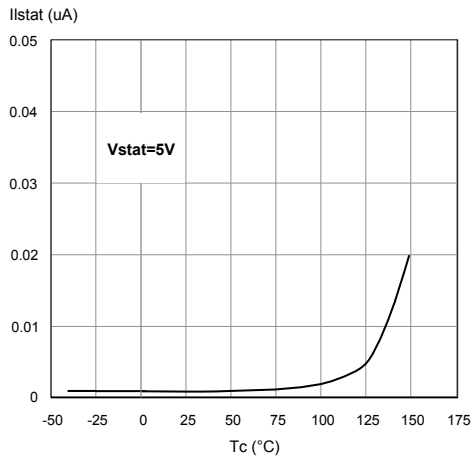
## 2.6 Electrical characterization for dual high-side switch



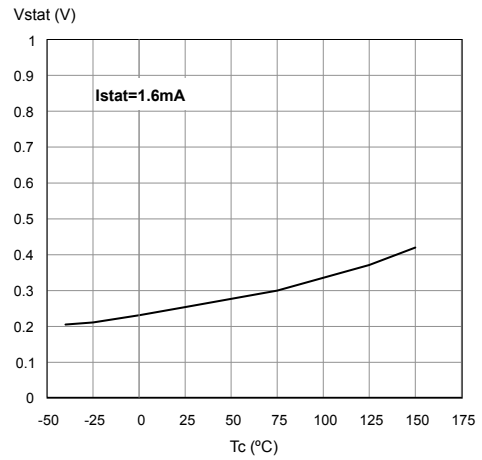




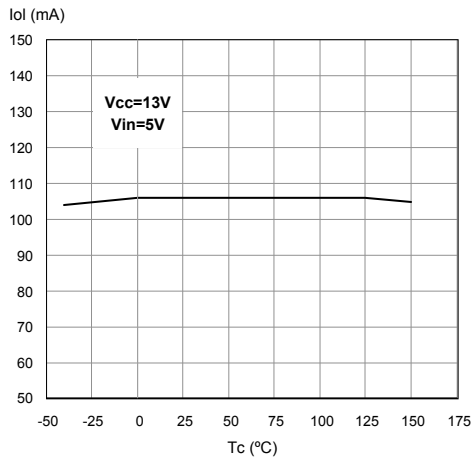
**Figure 18. Status leakage current**



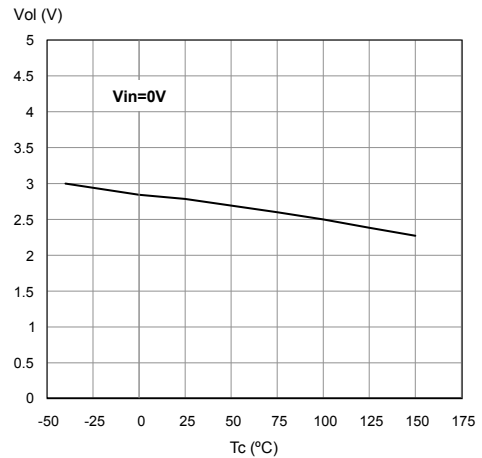
**Figure 19. Status low output voltage**



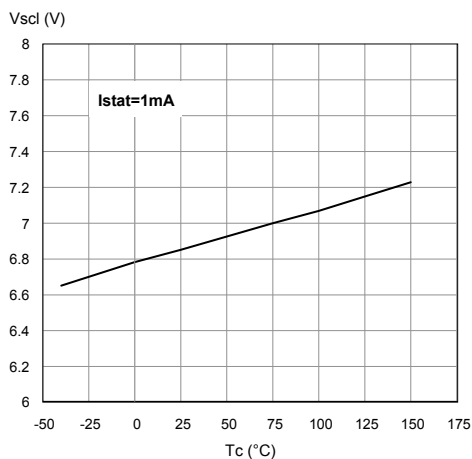
**Figure 20. Open-load on-state detection threshold**



**Figure 21. Open-load off-state voltage detection threshold**

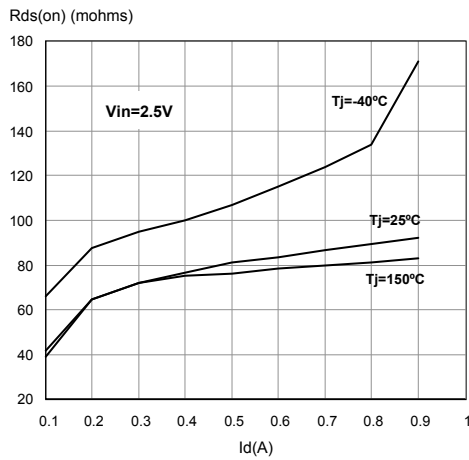


**Figure 22. Status clamp voltage**

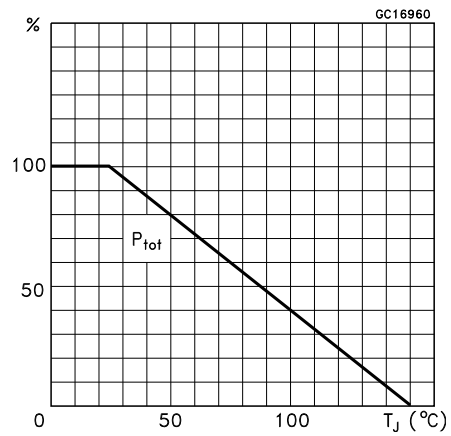


## 2.7 Electrical characterization for low-side switches

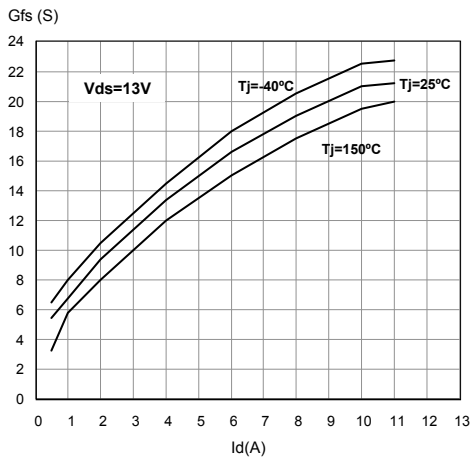
**Figure 23. Static drain source on resistance**



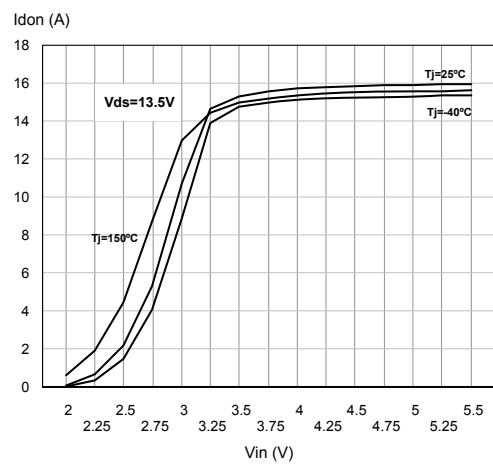
**Figure 24. Derating curve**



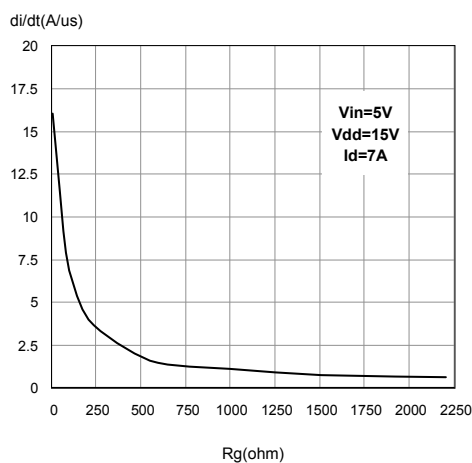
**Figure 25. Transconductance**



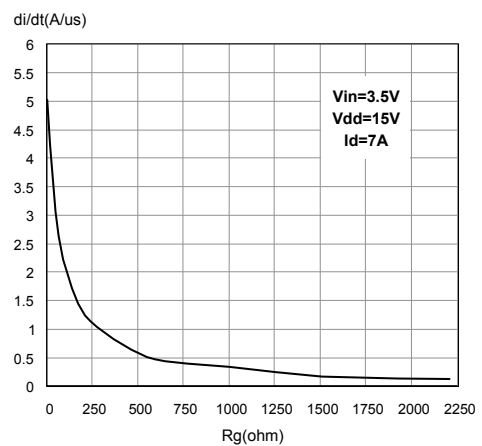
**Figure 26. Transfer characteristics**



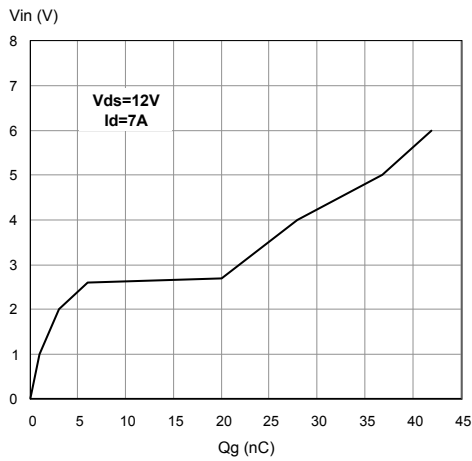
**Figure 27. Turn-on current slope ( $V_{IN} = 5 V$ )**



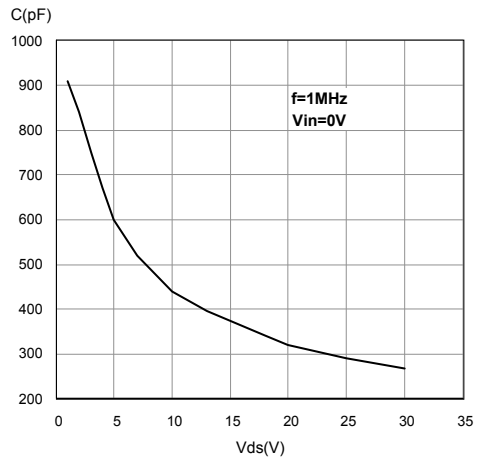
**Figure 28. Turn-on current slope ( $V_{IN} = 3.5 V$ )**



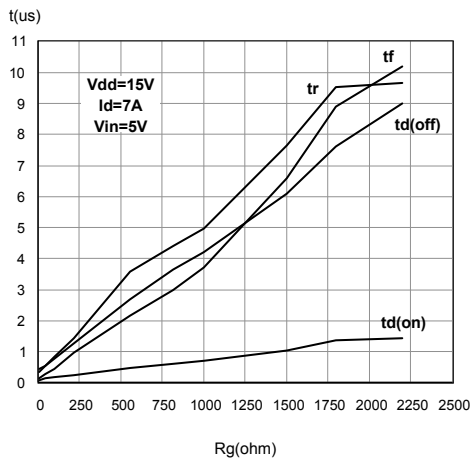
**Figure 29. Input voltage vs input charge**



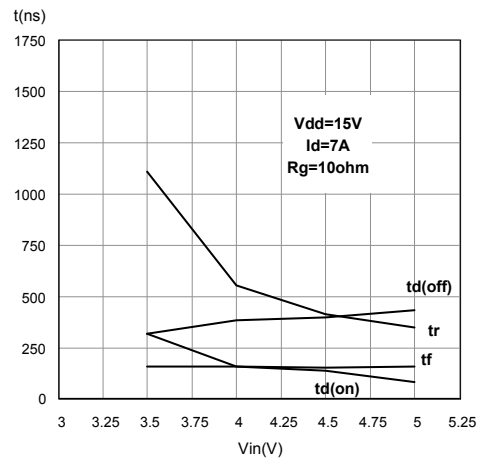
**Figure 30. Capacitance variations**



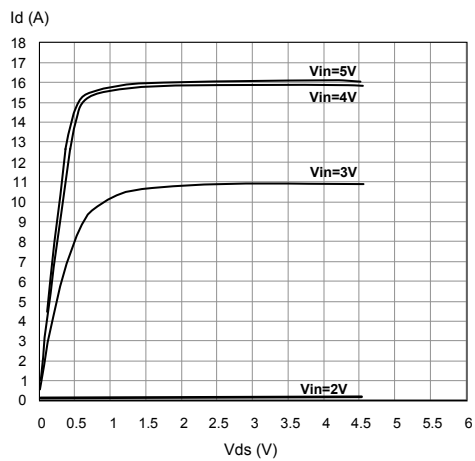
**Figure 31. Switching time resistive load ( $V_{IN} = 5 V$ )**



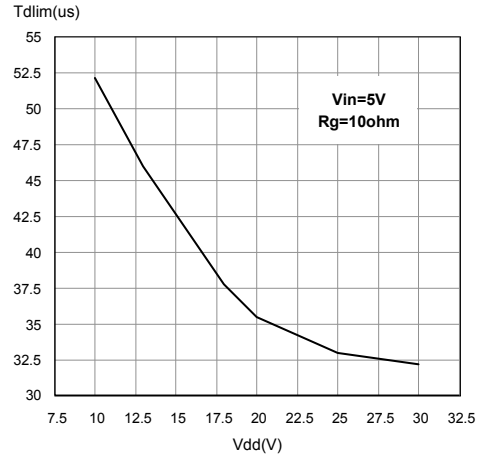
**Figure 32. Switching time resistive load ( $R_G = 10 \Omega$ )**



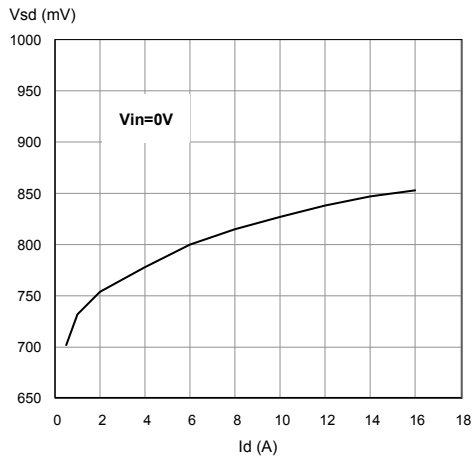
**Figure 33. Output characteristics**



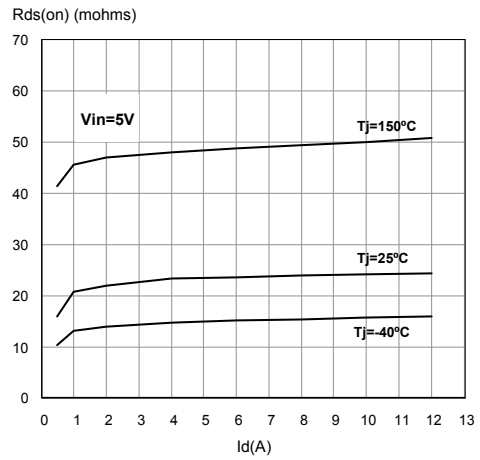
**Figure 34. Step response current limit**



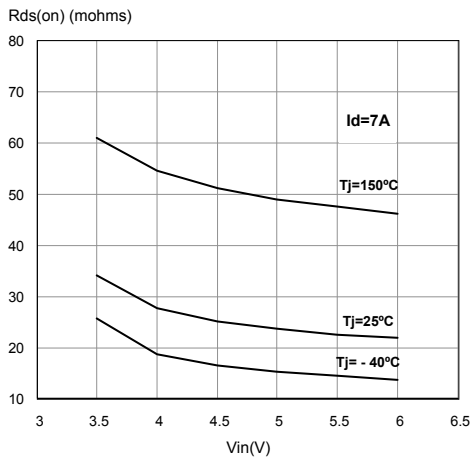
**Figure 35. Source drain diode forward characteristics**



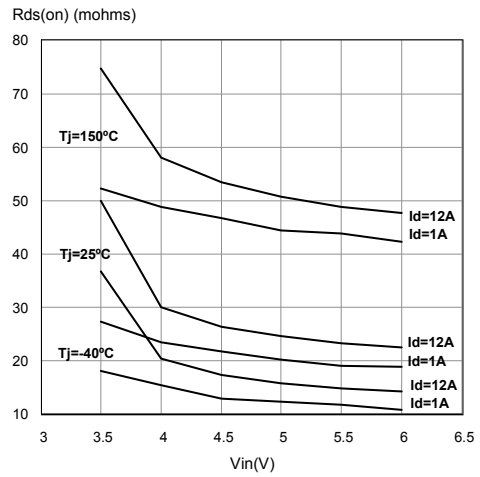
**Figure 36. Static drain source on resistance vs  $I_D$**



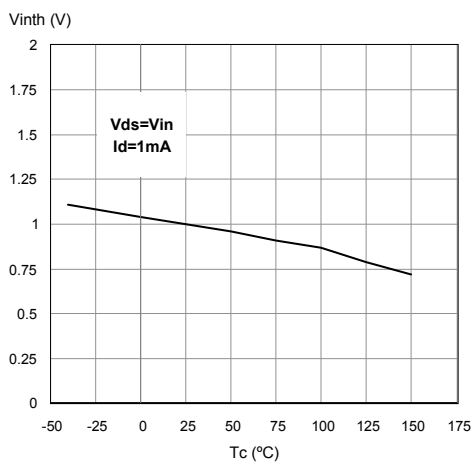
**Figure 37. Static drain source on resistance vs input voltage ( $I_D = 7\text{ A}$ )**



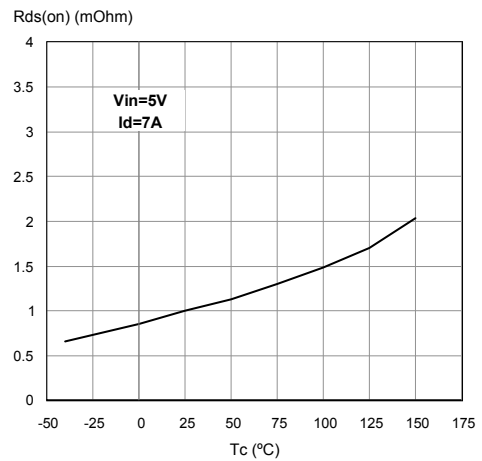
**Figure 38. Static drain source on resistance vs input voltage**



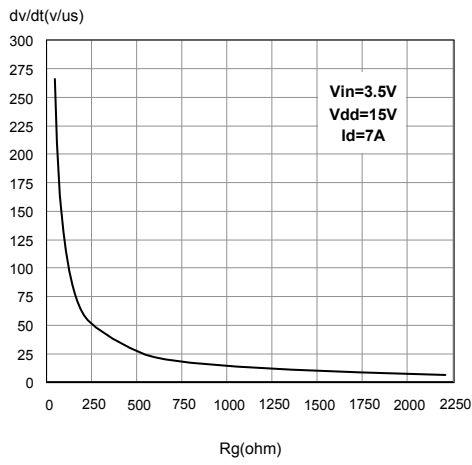
**Figure 39. Normalized input threshold voltage vs temperature**



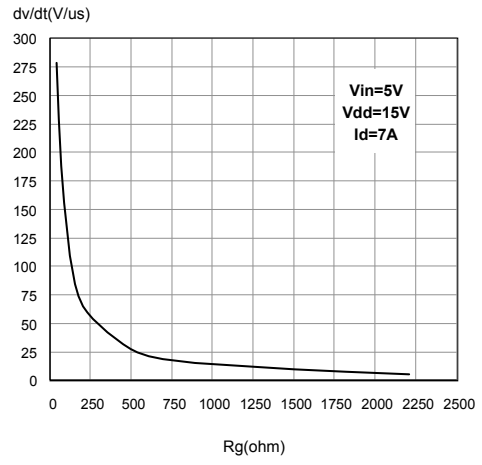
**Figure 40. Normalized on resistance vs temperature**



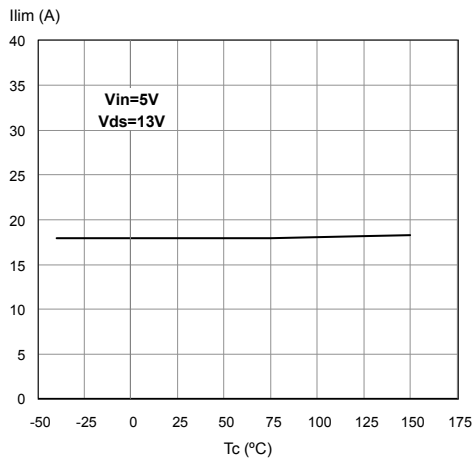
**Figure 41. Turn-off drain source voltage slope**  
**( $V_{IN} = 3.5\text{ V}$ )**



**Figure 42. Turn-off drain source voltage slope**  
**( $V_{IN} = 5\text{ V}$ )**

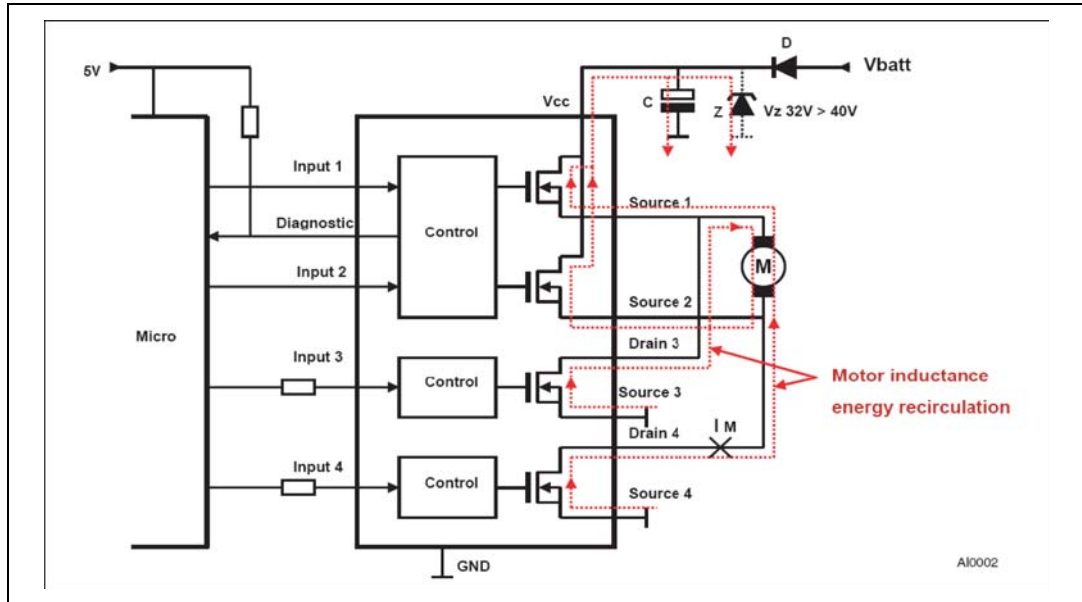


**Figure 43. Current limit vs junction temperature**



### 3 Application recommendations

Figure 44. Application diagram bridge drivers



Most motor bridge drivers use a reverse battery protection diode (D) inside the supply rail. This diode prevents a reverse current flow back to  $V_{BATT}$  in case the bridge becomes disabled via the logic inputs while motor inductance still carries energy. In order to prevent a hazardous overvoltage at circuit supply terminal ( $V_{CC}$ ), a blocking capacitor (C) is needed to limit the voltage overshoot. As basic orientation, 50  $\mu\text{F}$  per 1 A load current is recommended. As an alternative, a Zener protection (Z) is also suitable.

Even if a reverse polarity diode is not present, it is recommended to use a capacitor or Zener at  $V_{CC}$  because a similar problem appears in case the supply terminal of the module has intermittent electrical contact to the battery or gets disconnected while the motor is operating.

Figure 45. Recommended motor operation

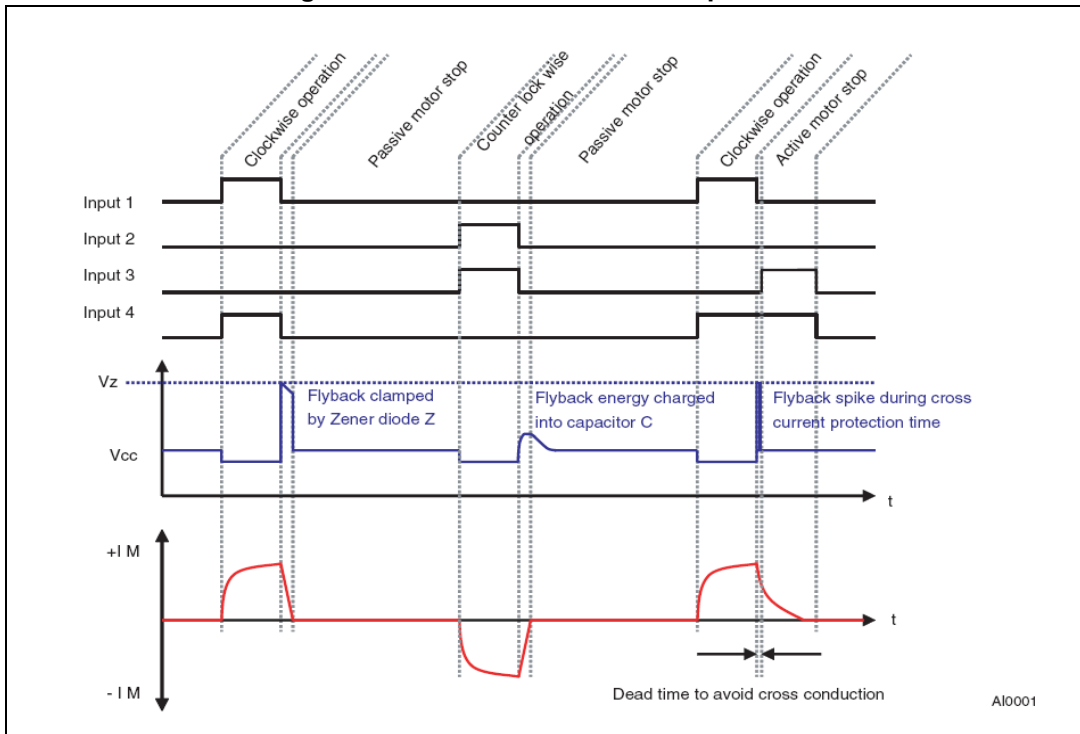
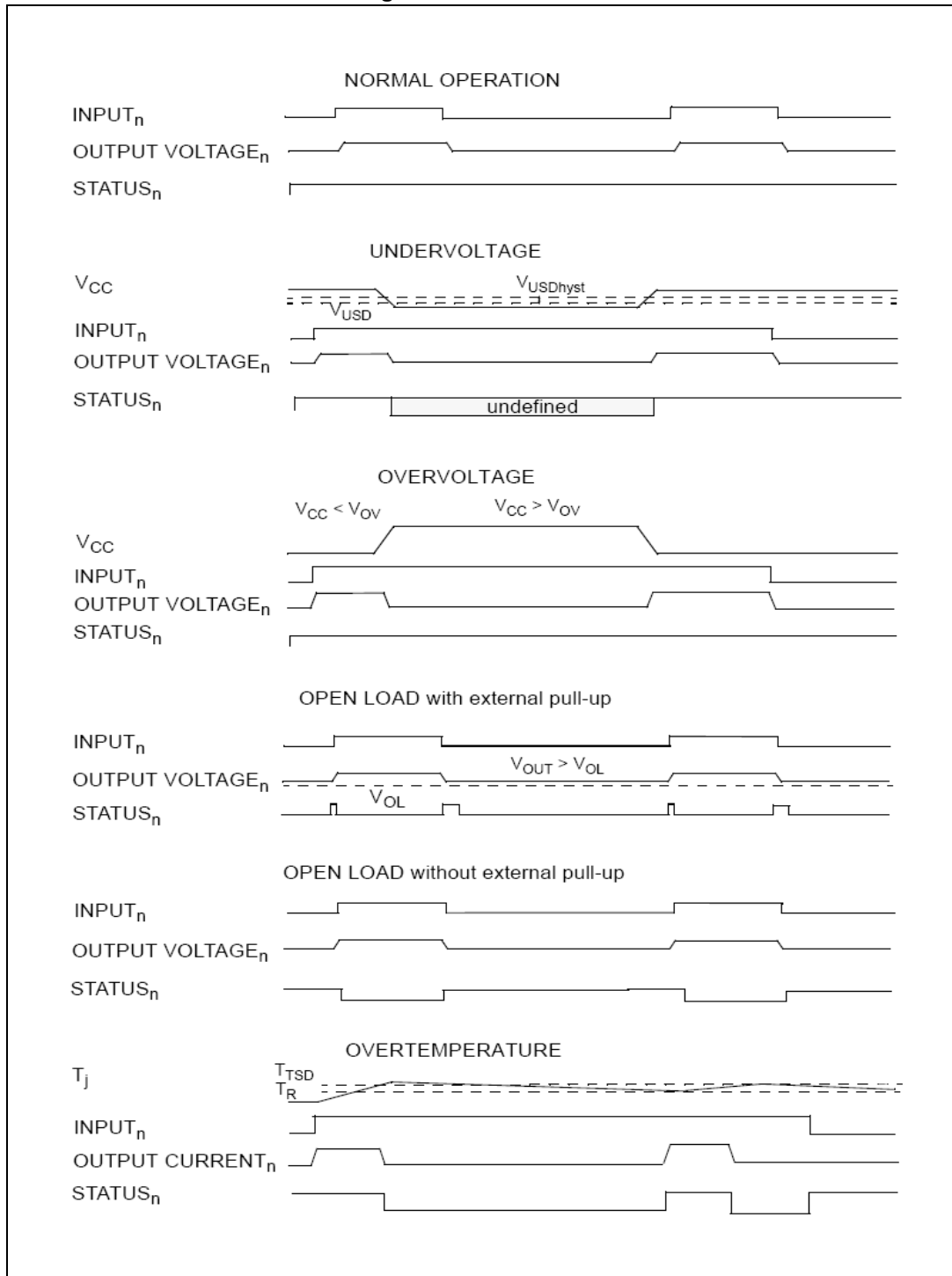


Figure 46. Waveforms

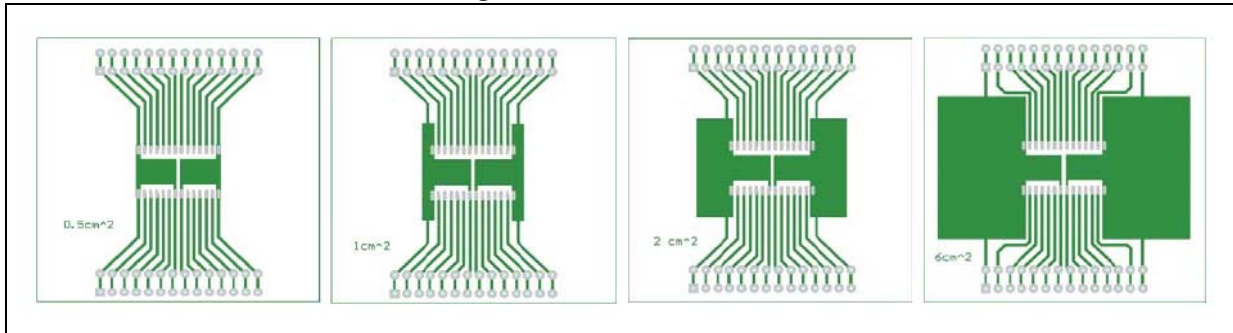




## 4 Thermal data

### 4.1 SO-28 thermal data

Figure 47. SO-28 PC board



Note: Layout condition of  $R_{th}$  and  $Z_{th}$  measurements (PCB FR4 area = 58mm x 58mm, PCB thickness = 2mm, Cu thickness = 35 $\mu$ m, Copper areas: from minimum pad layout to 6cm<sup>2</sup>).

Figure 48. Chipset configuration

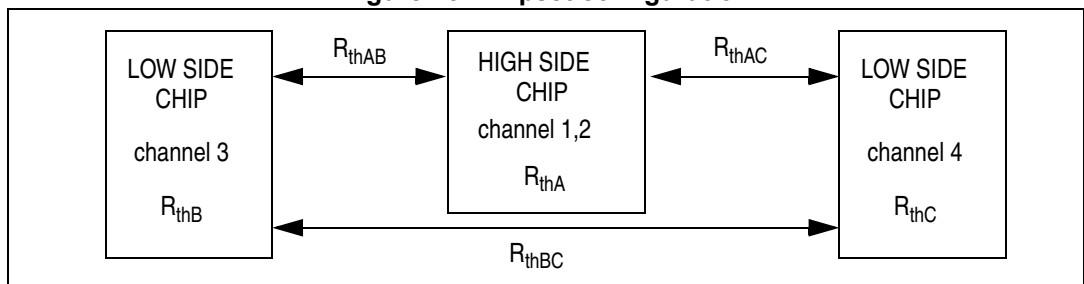
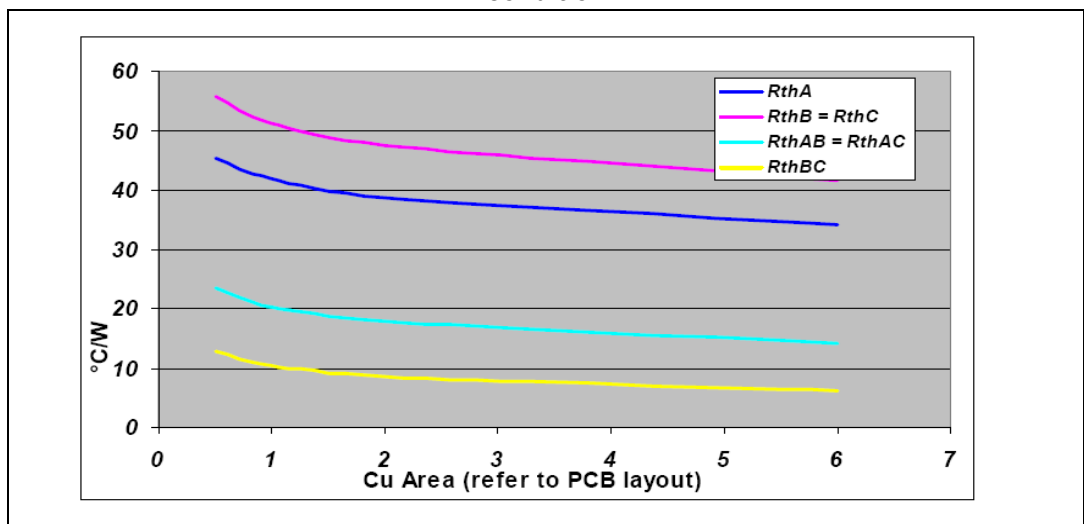


Figure 49. Auto and mutual  $R_{thj-amb}$  vs PCB copper area in open box free air condition



1. See definitions in [Section 5.2](#).

## 4.2 Thermal calculation in clockwise and anti-clockwise operation in steady state mode

**Table 19. Thermal calculation in clockwise and anti-clockwise operation in steady state mode**

HS <sub>1</sub>	HS <sub>2</sub>	LS <sub>3</sub>	LS <sub>4</sub>	T <sub>JHS12</sub>	T <sub>JLS3</sub>	T <sub>JLS4</sub>
On	Off	Off	On	$\frac{P_{dHS1} \times R_{thHS} + P_{dLS4} \times R_{thHSLs}}{R_{thHSLs} + T_{amb}}$	$\frac{P_{dHS1} \times R_{thHSLs} + P_{dLS4} \times R_{thLSLS}}{R_{thLSLS} + T_{amb}}$	$\frac{P_{dHS1} \times R_{thHSLs} + P_{dLS4} \times R_{thLS}}{R_{thLS} + T_{amb}}$
Off	On	On	Off	$\frac{P_{dHS2} \times R_{thHS} + P_{dLS3} \times R_{thHSLs}}{R_{thHSLs} + T_{amb}}$	$\frac{P_{dHS2} \times R_{thHSLs} + P_{dLS3} \times R_{thLS}}{R_{thLS} + T_{amb}}$	$\frac{P_{dHS2} \times R_{thHSLs} + P_{dLS3} \times R_{thLSLS}}{R_{thLSLS} + T_{amb}}$

### 4.2.1 Thermal resistances definition

Values according to the PCB heatsink area.

$R_{thHS} = R_{thHS1} = R_{thHS2}$  = high side chip thermal resistance junction to ambient (HS<sub>1</sub> or HS<sub>2</sub> in on-state)

$R_{thLS} = R_{thLS3} = R_{thLS4}$  = low side chip thermal resistance junction to ambient

$R_{thHSLs} = R_{thHS1LS4} = R_{thHS2LS3}$  = mutual thermal resistance junction to ambient between high side and low side chips

$R_{thLSLS} = R_{thLS3LS4}$  = mutual thermal resistance junction to ambient between low side chips

### 4.2.2 Thermal calculation in transient mode

$$T_{JHS12} = Z_{thHS} \times P_{dHS12} + Z_{thHSLs} \times (P_{dLS3} + P_{dLS4}) + T_{amb}$$

$$T_{JLS3} = Z_{thHSLs} \times P_{dHS12} + Z_{thLS} \times P_{dLS3} + Z_{thLSLS} \times P_{dLS4} + T_{amb}$$

$$T_{JLS4} = Z_{thHSLs} \times P_{dHS12} + Z_{thLSLS} \times P_{dLS3} + Z_{thLS} \times P_{dLS4} + T_{amb}$$

*Note:* Calculation is valid in any dynamic operating condition.  $P_d$  values set by user.

### 4.2.3 Single pulse thermal impedance definition

Values according to the PCB heatsink area.

$Z_{thHS}$  = high side chip thermal impedance junction to ambient

$Z_{thLS} = Z_{thLS3} = Z_{thLS4}$  = low side chip thermal impedance junction to ambient

$Z_{thHSLs} = Z_{thHS12LS3} = Z_{thHS12LS4}$  = mutual thermal impedance junction to ambient between high side and low side chips

$Z_{thLSLS} = Z_{thLS3LS4}$  = mutual thermal impedance junction to ambient between low side chips

### 4.2.4 Pulse calculation formula

$$Z_{TH\delta} = R_{TH} \cdot \delta + Z_{THtp}(1 - \delta)$$

where  $\delta = t_p/T$

Figure 50. SO-28 HSD thermal impedance junction ambient single pulse

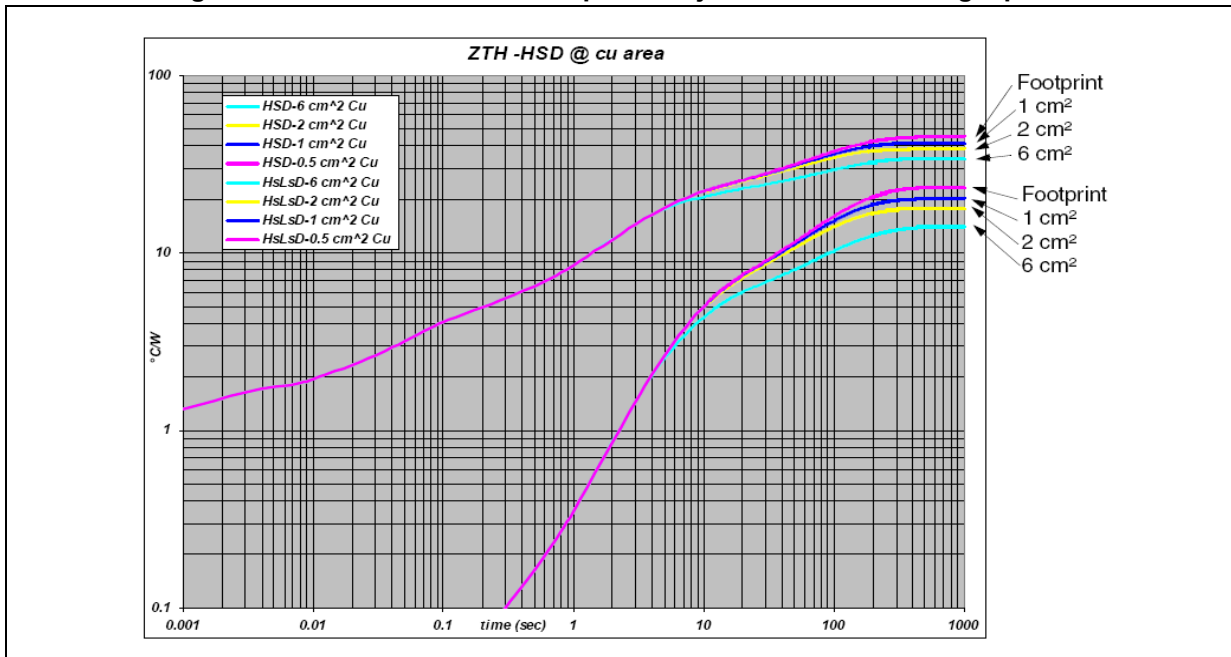


Figure 51. SO-28 LSD thermal impedance junction ambient single pulse

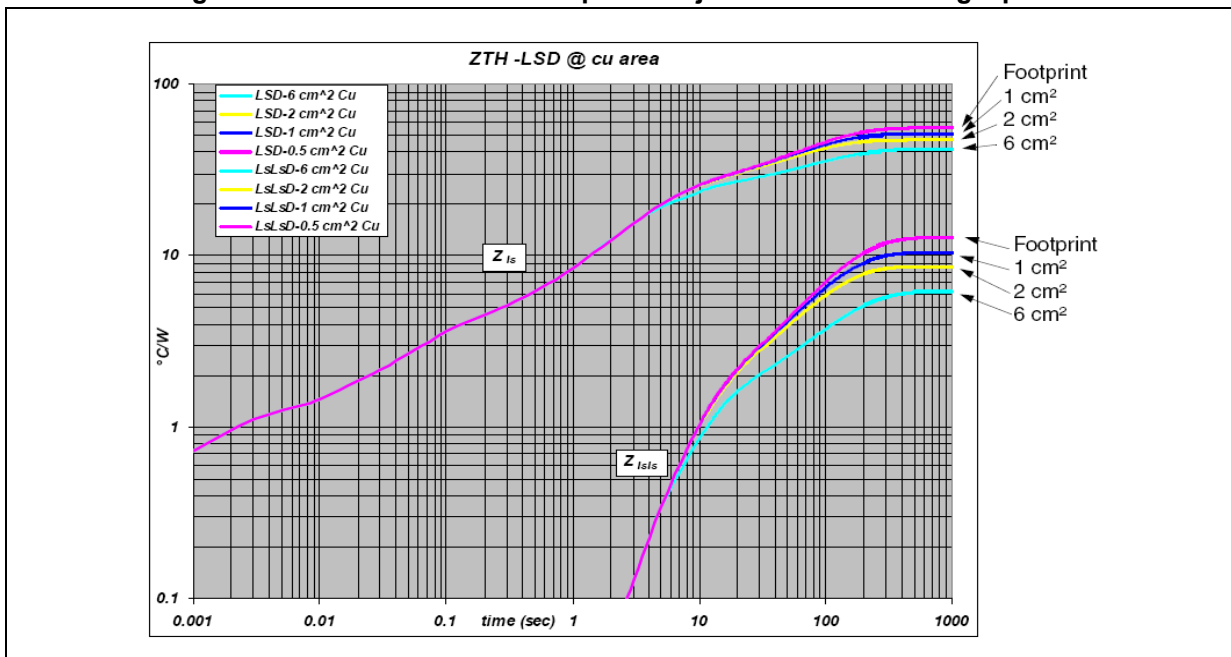


Figure 52. Thermal fitting model of an H-bridge in SO-28

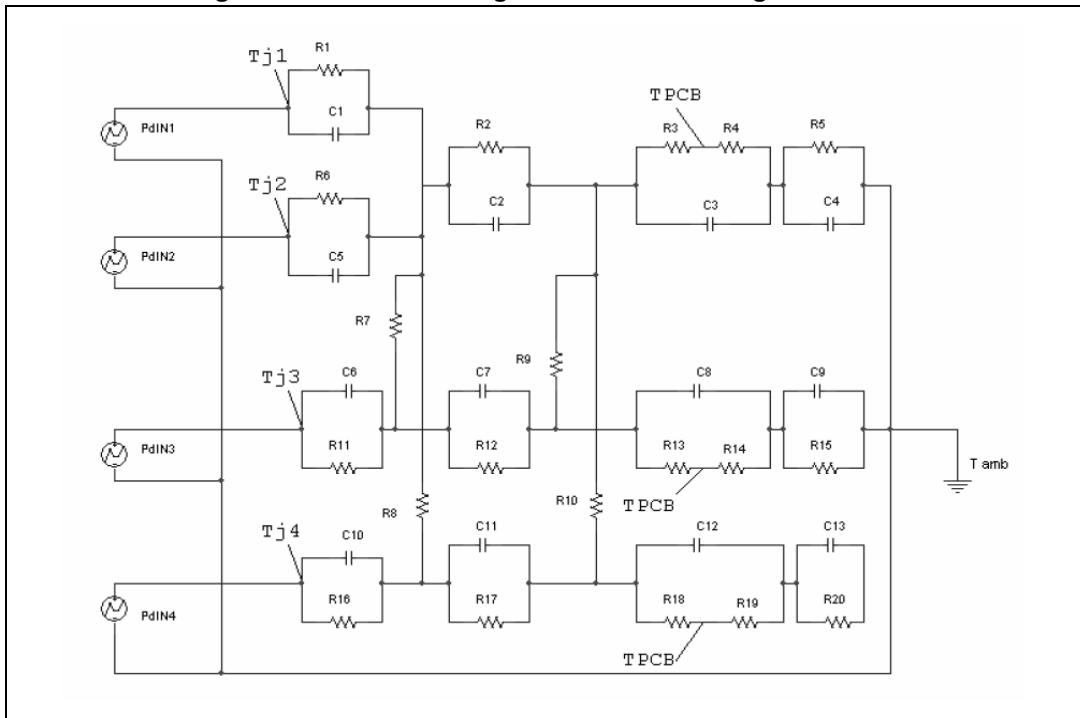


Table 20. Thermal parameters

Area/island (cm <sup>2</sup> )	Footprint	1	2	6
R1 = R6 (°C/W)	1.5	1.5	1.5	1.5
R2 (°C/W)	2.6	2.6	2.6	2.6
R12 = R17 (°C/W)	2.6	2.6	2.6	2.6
R3 = R13 = R 18 (°C/W)	15.5	15.5	15.5	15.5
R4 = R14 = R19 (°C/W)	10.5	10.5	10.5	10.5
R5 = R15 = R20 (°C/W)	62.28	52.28	44.28	32.28
R7 = R8 = R9 = R10 (°C/W)	150	150	150	150
R11 = R16 (°C/W)	1	1	1	1
C1 = C5 (W.s/°C)	0.00035	0.00035	0.00035	0.00035
C2 = C7 = C11 (W.s/°C)	0.024	0.024	0.024	0.024
C3 = C8 = C 12 (W.s/°C)	0.2	0.2	0.2	0.2
C4 = C9 = C13 (W.s/°C)	1.6	1.61	1.7	3.25
C6 = C10 (W.s/°C)	0.0009	0.0009	0.0009	0.0009

## 5 Package information

In order to meet environmental requirements, ST offers these devices in different grades of ECOPACK<sup>®</sup> packages, depending on their level of environmental compliance. ECOPACK<sup>®</sup> specifications, grade definitions and product status are available at: [www.st.com](http://www.st.com). ECOPACK<sup>®</sup> is an ST trademark.

### 5.1 SO-28 package information

Figure 53. SO-28 package outline

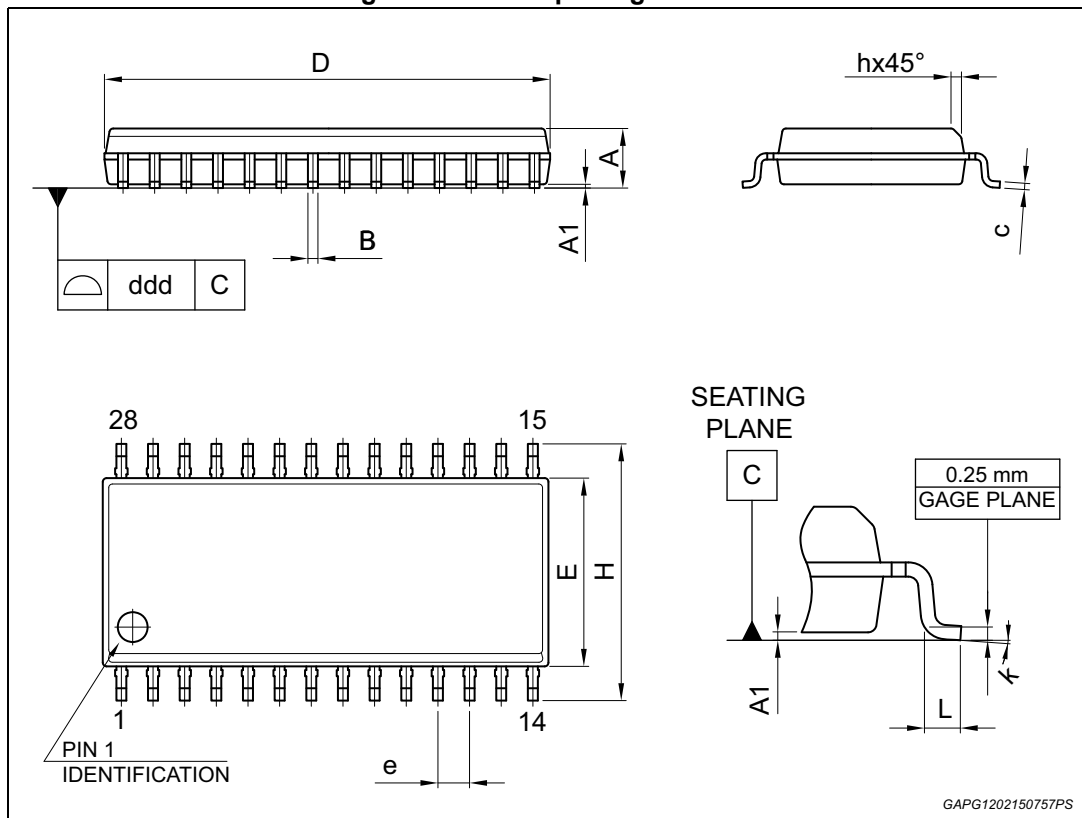


Table 21. SO-28 mechanical data

Ref.	Dimension		
	Millimeters		
	Min.	Typ	Max.
A	2.35		2.65
A1	0.10		0.30
B	0.33		0.51
C	0.23		0.32
D <sup>(1)</sup>	17.70		18.10
E	7.40		7.60
e		1.27	
H	10.00		10.65
h	0.25		0.75
L	0.40		1.27
k	0°		8°
ddd			0.10

1. Dimension "D" does not include mold flash, protrusions or gate burrs. Mold flash, protrusions or gate burrs shall not exceed 0.15 mm per side.

## 5.2 SO-28 Packing information

Figure 54. Tube dimensions (no suffix)

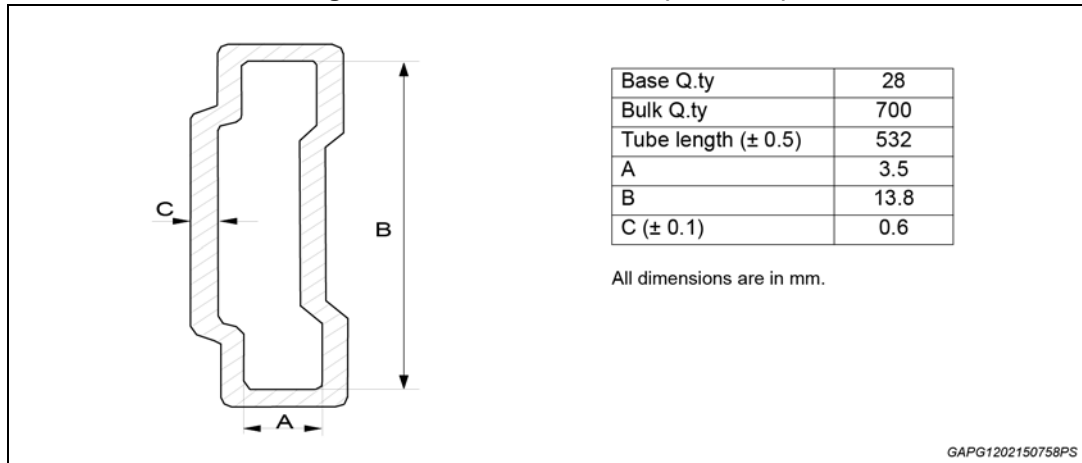
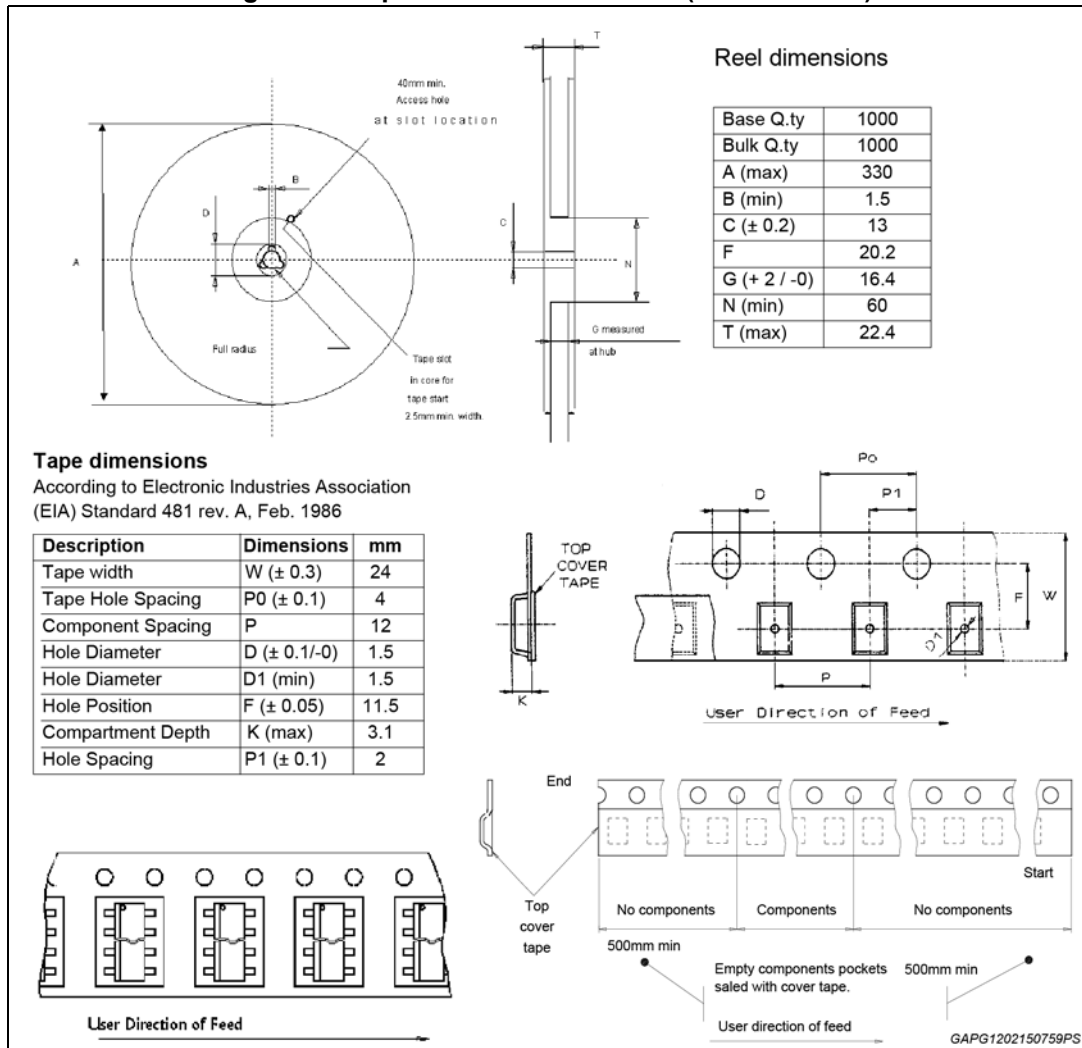


Figure 55. Tape and reel dimensions (suffix "13TR")



## 6 Revision history

Table 22. Document revision history

Date	Revision	Changes
01-Jun-2011	1	Initial release.
18-Sep-2013	2	Updated Disclaimer
16-Feb-2015	3	Updated <a href="#">Chapter 5: Package information</a>



**IMPORTANT NOTICE – PLEASE READ CAREFULLY**

STMicroelectronics NV and its subsidiaries ("ST") reserve the right to make changes, corrections, enhancements, modifications, and improvements to ST products and/or to this document at any time without notice. Purchasers should obtain the latest relevant information on ST products before placing orders. ST products are sold pursuant to ST's terms and conditions of sale in place at the time of order acknowledgement.

Purchasers are solely responsible for the choice, selection, and use of ST products and ST assumes no liability for application assistance or the design of Purchasers' products.

No license, express or implied, to any intellectual property right is granted by ST herein.

Resale of ST products with provisions different from the information set forth herein shall void any warranty granted by ST for such product.

ST and the ST logo are trademarks of ST. All other product or service names are the property of their respective owners.

Information in this document supersedes and replaces information previously supplied in any prior versions of this document.

© 2015 STMicroelectronics – All rights reserved

# Mouser Electronics

Authorized Distributor

Click to View Pricing, Inventory, Delivery & Lifecycle Information:

[STMicroelectronics:](#)

[VN771KP-E](#) [VN771KPTR-E](#)