



17µA Max, Dual/Quad, Single-Supply, Precision Op Amps

MAX478/MAX479

General Description

The MAX478 and MAX479 are dual and quad micro-power, precision op amps available in 8-pin and 14-pin DIP and small-outline packages, respectively. Both devices feature an extremely low, 17 µA max supply current per op amp, 70µV max offset voltage, 2.2µV/°C max offset voltage drift (0.5µV/°C typ), and 250pA max input offset current.

The MAX478 and MAX479 operate from a single supply. The input voltage range includes ground, and the output swings to within a few millivolts of ground, which eliminates pull-down resistors and saves power.

Both devices are optimized for single 3V and 5V supply operation, with guaranteed specifications at each supply voltage. Specifications for ±15V operation are also provided.

Applications

Battery- or Solar-Powered Systems:

- Portable Instrumentation
- Remote Sensor Amplifier
- Satellite Circuitry

Micropower Sample-and-Hold

Thermocouple Amplifier

Micropower Filters

Single Lithium Cell Powered Systems

Typical Operating Circuit

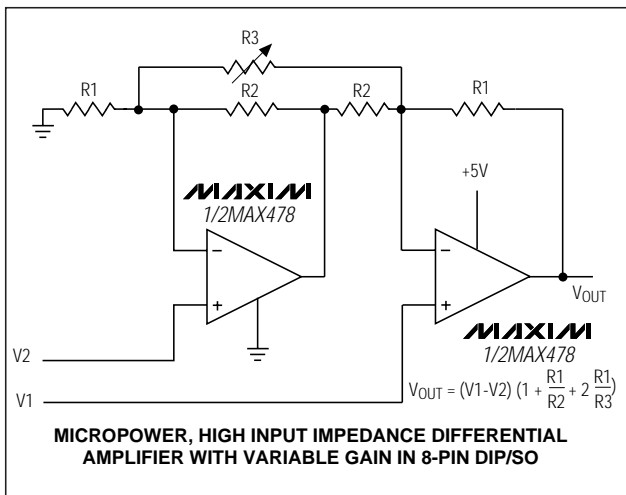

Features

- ◆ 17µA Max Supply Current (MAX478A/MAX479A)
- ◆ 70µV Max Offset Voltage (MAX478A)
- ◆ Single-Supply Operation:
 - Input Voltage Range Includes Ground
 - Output Swings to Ground While Sinking Current
 - No Pull-Down Resistors Required
- ◆ Dual Op Amp in 8-Pin DIP/SO Package (MAX478)
Quad Op Amp in 14-Pin DIP/SO Package (MAX479)
- ◆ 250pA Max Input Offset Current (MAX478A/MAX479A)
- ◆ 0.5µV/°C Offset-Voltage Drift
- ◆ Output Sources and Sinks 5mA Load Current

Ordering Information

PART	TEMP. RANGE	PIN-PACKAGE
MAX478ACPA	0°C to +70°C	8 Plastic DIP
MAX478CPA	0°C to +70°C	8 Plastic DIP
MAX478CSA	0°C to +70°C	8 SO
MAX478C/D	0°C to +70°C	Dice*
MAX478EPA	-40°C to +85°C	8 Plastic DIP
MAX478ESA	-40°C to +85°C	8 SO
MAX479ACPD	0°C to +70°C	14 Plastic DIP
MAX479CPD	0°C to +70°C	14 Plastic DIP
MAX479CSD	0°C to +70°C	14 SO
MAX479EPD	-40°C to +85°C	14 Plastic DIP
MAX479ESD	-40°C to +85°C	14 SO

* Dice are specified at $T_A = +25^\circ\text{C}$, DC parameters only.

Pin Configurations

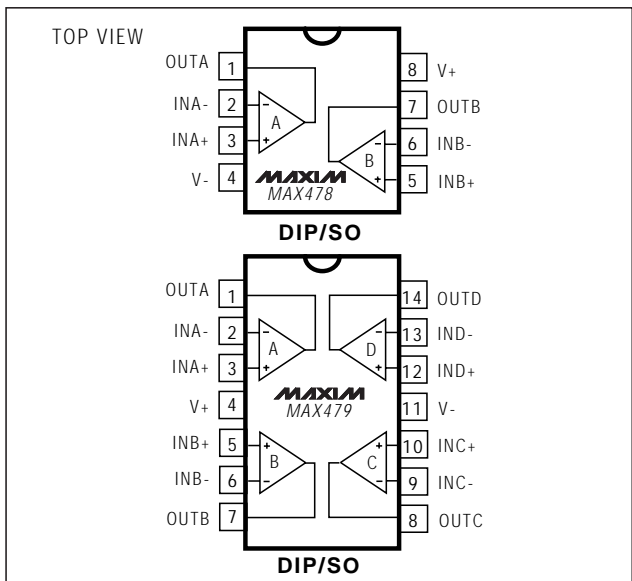

17 μ A Max, Dual/Quad, Single-Supply, Precision Op Amps

ABSOLUTE MAXIMUM RATINGS

Supply Voltage	± 22 V
Differential Input Voltage	± 30 V
Input Voltage	Equal to Positive Supply Voltage 5V Below Negative Supply Voltage
Output Short-Circuit Duration	Continuous
Continuous Power Dissipation ($T_A = +70^\circ\text{C}$):	
8-Pin Plastic DIP (derate 9.09mW/ $^\circ\text{C}$ above $+70^\circ\text{C}$)	727mW
14-Pin Plastic DIP (derate 10.00mW/ $^\circ\text{C}$ above $+70^\circ\text{C}$) ..	800mW
14-Pin Wide SO (derate 9.52mW/ $^\circ\text{C}$ above $+70^\circ\text{C}$) ...	762mW

Operating Temperature Ranges:	
MAX47_ACP_JC_	0°C to $+70^\circ\text{C}$
MAX47_E_	-40°C to $+85^\circ\text{C}$
Storage Temperature Range	-65°C to $+150^\circ\text{C}$
Lead Temperature (soldering, 10sec)	$+300^\circ\text{C}$

Stresses beyond those listed under "Absolute Maximum Ratings" may cause permanent damage to the device. These are stress ratings only, and functional operation of the device at these or any other conditions beyond those indicated in the operational sections of the specifications is not implied. Exposure to absolute maximum rating conditions for extended periods may affect device reliability.

ELECTRICAL CHARACTERISTICS: 5V

($V_S = 5\text{V}$, 0V , $V_{CM} = 0.1\text{V}$, $V_O = 1.4\text{V}$, $T_A = +25^\circ\text{C}$, unless otherwise noted.)

PARAMETER	SYMBOL	CONDITIONS	MAX478AC MAX479AC			MAX478C/E MAX479C/E			UNITS
			MIN	TYP	MAX	MIN	TYP	MAX	
Input Offset Voltage	V_{OS}	MAX478ACP/CP/EP	30	70		40	120	μV	
		MAX479ACP/CP/EP	35	100		40	150		
		MAX478CS/ES				80	180		
		MAX479CS/ES				90	250		
Long-Term Input Offset-Voltage Stability	$\frac{\Delta V_{OS}}{\Delta \text{Time}}$		0.5		0.6		$\mu\text{V}/\text{Mo.}$		
Input Offset Current	I_{OS}		0.05	0.25	0.05	0.35	nA		
Input Bias Current	I_B		3	5	3	6	nA		
Input Noise Voltage	e_n	0.1Hz to 10Hz (Note 1)	0.9	2.0	0.9		μV_{p-p}		
Input Noise Voltage Density		$f_O = 10\text{Hz}$ (Note 1)	50	75	50		$\text{nV}/\sqrt{\text{Hz}}$		
		$f_O = 1000\text{Hz}$ (Note 1)	49	65	49				
Input Noise Current	i_n	0.1Hz to 10Hz (Note 1)	1.5	2.5	1.5		pA_{p-p}		
Input Noise Current Density		$f_O = 10\text{Hz}$ (Note 1)	0.03	0.07	0.03		$\text{pA}/\sqrt{\text{Hz}}$		
		$f_O = 1000\text{Hz}$	0.01		0.01				
Input Resistance	R_{IN}	Differential mode (Note 1)	0.8	2.0	0.6	2.0	$\text{G}\Omega$		
		Common mode		12		12			
Input Voltage Range	$V_{IN(CM)}$	Upper limit	3.5	3.9	3.5	3.9	V		
		Lower limit	0	-0.3	0	-0.3			
Common-Mode Rejection Ratio	CMRR	$V_{CM} = 0\text{V}$ to 3.5V	93	103	90	102	dB		
Power-Supply Rejection Ratio	PSRR	$V_S = 2.2\text{V}$ to 12V	94	104	92	104	dB		
Large-Signal Voltage Gain	A_{VOL}	$V_O = 0.03\text{V}$ to 4V , no load (Note 1)	140	700	110	700	V/mV		
		$V_O = 0.03\text{V}$ to 3.5V , $R_L = 50\text{k}\Omega$	80	200	70	200			

17μA Max, Dual/Quad, Single-Supply, Precision Op Amps

MAX478/MAX479

ELECTRICAL CHARACTERISTICS: 5V (continued)

($V_S = 5V$, $0V$, $V_{CM} = 0.1V$, $V_O = 1.4V$, $T_A = +25^\circ C$, unless otherwise noted.)

PARAMETER	SYMBOL	CONDITIONS	MAX478AC MAX479AC			MAX478C/E MAX479C/E			UNITS
			MIN	TYP	MAX	MIN	TYP	MAX	
Output Voltage Swing	V_{OUT}	Output low, no load	6.5	9.0		6.5	9.0	mV	
		Output low, 2kΩ to GND	0.2	0.6		0.2	0.6		
		Output low, $I_{SINK} = 100\mu A$	120	160		120	160		
		Output high, no load	4.2	4.4		4.2	4.4	V	
		Output high, 2kΩ to GND	3.5	3.8		3.5	3.8		
Slew Rate	SR	$A_V = +1$, $C_L = 1pF$ (Note 1)	0.013	0.025		0.013	0.025	V/μs	
Gain-Bandwidth Product	GBW	$f_O \leq 5kHz$		60			60	kHz	
Supply Current per Amplifier	I_S			13	18		14	21	μA
		$V_S = \pm 1.5V$, $V_O = 0V$		12	17		13	20	
Channel Separation		$\Delta V_{IN} = 3V$, $R_L = 10k\Omega$		130			130	dB	
Minimum Supply Voltage	V_S	(Note 2)		2.0	2.2		2.0	2.2	V

ELECTRICAL CHARACTERISTICS: 5V

($V_S = 5V$, $0V$, $V_{CM} = 0.1V$, $V_O = 1.4V$, $T_A = 0^\circ C$ to $+70^\circ C$, unless otherwise noted.)

PARAMETER	SYMBOL	CONDITIONS	MAX478AC MAX479AC			MAX478C MAX479C			UNITS
			MIN	TYP	MAX	MIN	TYP	MAX	
Input Offset Voltage	V_{OS}	MAX478ACP/CP		50	170		65	250	μV
		MAX479ACP/CP		60	200		70	290	
		MAX478CS					120	300	
		MAX479CS					130	400	
Input Offset Voltage Drift	$\frac{\Delta V_{OS}}{\Delta T}$	MAX47_ACP/CP (Note 1)		0.5	2.2		0.6	3.0	μV/°C
		MAX47_CS (Note 1)					0.8	4.5	
Input Offset Current	I_{OS}			0.06	0.35		0.06	0.50	nA
Input Bias Current	I_B			3	6		3	7	nA
Common-Mode Rejection Ratio	CMRR	$V_{CM} = 0V$ to 3.4V		90	101		86	100	dB
Power-Supply Rejection Ratio	PSRR	$V_S = 2.5V$ to 12V		90	102		88	102	dB
Large-Signal Voltage Gain	A_{VOL}	$V_O = 0.05V$ to 4V, no load (Note 1)		105	500		80	500	V/mV
		$V_O = 0.05V$ to 3.5V, $R_L = 50k\Omega$		55	160		45	160	
Output Voltage Swing	V_{OUT}	Output low, no load		8	11		8	11	mV
		Output low, $I_{SINK} = 100\mu A$		140	190		140	190	
		Output high, no load		4.1	4.3		4.1	4.3	V
		Output high, 2kΩ to GND		3.3	3.8		3.3	3.8	
Supply Current per Amplifier	I_S			14	21		15	24	μA

17 μ A Max, Dual/Quad, Single-Supply, Precision Op Amps

ELECTRICAL CHARACTERISTICS: 5V

($V_S = 5V$, $0V$, $V_{CM} = 0.1V$, $V_O = 1.4V$, $T_A = -40^\circ C$ to $+85^\circ C$, unless otherwise noted.)

PARAMETER	SYMBOL	CONDITIONS	MAX478EP MAX479EP			MAX478ES MAX479ES			UNITS
			MIN	TYP	MAX	MIN	TYP	MAX	
Input Offset Voltage	V_{OS}	MAX478	80	315		150	400	μV	
		MAX479	80	345		160	530		
Input Offset Voltage Drift	$\frac{\Delta V_{OS}}{\Delta T}$	(Note 1)	0.6	3.0		0.8	4.5	$\mu V/^\circ C$	
Input Offset Current	I_{OS}		0.07	0.7		0.07	0.7	nA	
Input Bias Current	I_B		4	8		4	8	nA	
Common-Mode Rejection Ratio	CMRR	$V_{CM} = 0.05V$ to $3.2V$	84	98		84	98	dB	
Power-Supply Rejection Ratio	PSRR	$V_S = 3.0V$ to $12V$	86	100		86	100	dB	
Large-Signal Voltage Gain	A_{VOL}	$V_O = 0.05V$ to $4V$, no load (Note 1)	55	350		55	350	V/mV	
		$V_O = 0.05V$ to $3.5V$, $R_L = 50k\Omega$	35	130		35	130		
Output Voltage Swing	V_{OUT}	Output low, no load	9	13		9	13	mV	
		Output low, $I_{SINK} = 100\mu A$	160	220		160	220		
		Output high, no load	3.9	4.2		3.9	4.2	V	
		Output high, $2k\Omega$ to GND	3.0	3.7		3.0	3.7		
Supply Current per Amplifier	I_S		15	27		15	27	μA	

17 μ A Max, Dual/Quad, Single-Supply, Precision Op Amps

MAX478/MAX479

ELECTRICAL CHARACTERISTICS: 3V

($V_S = 3V$, $0V$, $V_{CM} = 0.1V$, $V_O = 0.8V$, $T_A = +25^\circ C$, unless otherwise noted.)

PARAMETER	SYMBOL	CONDITIONS	MAX478AC MAX479AC			MAX478C/E MAX479C/E			UNITS
			MIN	TYP	MAX	MIN	TYP	MAX	
Input Offset Voltage	V_{OS}	MAX478ACP/CP/EP	30	90		40	140	μV	
		MAX479ACP/CP/EP	35	120		40	170		
		MAX478CS/ES				80	200		
		MAX479CS/ES				90	270		
Input Offset Current	I_{OS}		0.05		0.05		nA		
Input Bias Current	I_B		3		3		nA		
Input Noise Voltage	e_N	0.1Hz to 10Hz		1.0		1.0	μV_{p-p}		
Input Voltage Range	$V_{IN(CM)}$	Upper limit	1.7	1.9		1.7	1.9	V	
		Lower limit	0	-0.3		0	-0.3		
Common-Mode Rejection Ratio	CMRR	$V_{CM} = 0V$ to 1.7V	93	103		90	102	dB	
Power-Supply Rejection Ratio	PSRR	$V_S = 2.2V$ to 12V	94	104		92	104	dB	
Large-Signal Voltage Gain	A_{VOL}	$V_O = 0.03V$ to 2V, no load (Note 1)	100	600		100	600	V/mV	
		$V_O = 0.03V$ to 1.5V, $R_L = 50k\Omega$	30	180		30	180		
Output Voltage Swing	V_{OUT}	Output low, no load		6	9		6	9	mV
		Output low, 2k Ω to GND		0.2	0.6		0.2	0.6	
		Output high, no load		2.2	2.4		2.2	2.4	V
		Output high, 2k Ω to GND		1.8	2.0		1.8	2.0	
Gain-Bandwidth Product	GBW	$f_O \leq 5kHz$		50		50		kHz	
Supply Current per Amplifier	I_S		12	17		13	20	μA	
Minimum Supply Voltage	V_S			2.2		2.2		V	
		With 300 μV V_{OS} degradation	1.7			1.7			

17 μ A Max, Dual/Quad, Single-Supply, Precision Op Amps

ELECTRICAL CHARACTERISTICS: ± 15 V

($V_S = \pm 15$ V, $T_A = +25^\circ\text{C}$, unless otherwise noted.)

PARAMETER	SYMBOL	CONDITIONS	MAX478AC MAX479AC			MAX478C/E MAX479C/E			UNITS
			MIN	TYP	MAX	MIN	TYP	MAX	
Input Offset Voltage	V_{OS}		80	350		100	480	μV	
Input Offset Current	I_{OS}		0.05	0.25		0.05	0.35	nA	
Input Bias Current	I_B		3	5		3	6	nA	
Input Voltage Range	$V_{IN(CM)}$	Upper limit	13.5	13.9		13.5	13.9	V	
		Lower limit	-15.0	-15.3		-15.0	-15.3		
Common-Mode Rejection Ratio	CMRR	$V_{CM} = +13.5\text{V}, -15\text{V}$	97	106		94	106	dB	
Power-Supply Rejection Ratio	PSRR	$V_S = 5\text{V}, 0\text{V to } \pm 15\text{V}$	96	112		94	112	dB	
Large-Signal Voltage Gain	A_{VOL}	$V_O = \pm 10\text{V}, R_L = 50\text{k}\Omega$	300	1200		250	1000	V/mV	
		$V_O = \pm 10\text{V}, \text{no load}$	600	2500		400	2500		
Output Voltage Swing	V_{OUT}	$R_L = 50\text{k}\Omega$	± 13.0	± 14.2		± 13.0	± 14.2	V	
		$R_L = 2\text{k}\Omega$	± 11.0	± 12.7		± 11.0	± 12.7		
Slew Rate	SR	$A_V = +1\text{V}, C_L = 15\text{pF}$	0.02	0.04		0.02	0.04	V/ μs	
Gain-Bandwidth Product	GBW	$f_O \leq 5\text{kHz}$	85			85		kHz	
Supply Current per Amplifier	I_S		16	21		17	25	μA	

17μA Max, Dual/Quad, Single-Supply, Precision Op Amps

MAX478/MAX479

ELECTRICAL CHARACTERISTICS: ±15V

(V_S = ±15V, T_A = 0°C to +70°C, unless otherwise noted.)

PARAMETER	SYMBOL	CONDITIONS	MAX478AC MAX479AC		MAX478C MAX479C		UNITS
			MIN	TYP	MAX	MIN	
Input Offset Voltage	V _{OS}		100	480	130	660	μV
Input Offset-Voltage Drift	$\frac{\Delta V_{OS}}{\Delta T}$	MAX47_ACP/CP (Note 1)	0.6	2.8	0.7	4.0	μV/°C
		MAX47_CS (Note 1)			0.9	5.5	
Input Offset Current	I _{OS}		0.06	0.35	0.06	0.35	nA
Input Bias Current	I _B		3	6	3	7	nA
Large-Signal Voltage Gain	A _{VOL}	V _O = ±10V, R _L = 50kΩ	200	800	150	750	V/mV
Common-Mode Rejection Ratio	CMRR	V _{CM} = +13V, -15V	94	104	91	104	dB
Power-Supply Rejection Ratio	PSRR	V _S = 5V, 0V to ±15V	93	110	91	110	dB
Output Voltage Swing	V _{OUT}	R _L = 5kΩ	±11.0	±13.5	±11.0	±13.5	V
Supply Current per Amplifier	I _S		17	24	18	28	μA

17 μ A Max, Dual/Quad, Single-Supply, Precision Op Amps

ELECTRICAL CHARACTERISTICS: ± 15 V

($V_S = \pm 15$ V, $T_A = -40^\circ\text{C}$ to $+85^\circ\text{C}$, unless otherwise noted.)

PARAMETER	SYMBOL	CONDITIONS	MAX478EP MAX479EP			MAX478ES MAX479ES			UNITS
			MIN	TYP	MAX	MIN	TYP	MAX	
Input Offset Voltage	V_{OS}			130	740		130	740	μV
Input Offset-Voltage Drift	$\frac{\Delta V_{OS}}{\Delta T}$	(Note 1)		0.7	4.0		0.9	5.5	$\mu\text{V}/^\circ\text{C}$
Input Offset Current	I_{OS}			0.07	0.70		0.07	0.70	nA
Input Bias Current	I_B			4	8		4	8	nA
Large-Signal Voltage Gain	A_{VOL}	$V_O = \pm 10\text{V}$, $R_L = 50\text{k}\Omega$	100	500		100	500		V/mV
Common-Mode Rejection Ratio	CMRR	$V_{CM} = +13\text{V}$, -14.9V	88	103		88	103		dB
Power-Supply Rejection Ratio	PSRR	$V_S = 5\text{V}$, 0V to $\pm 15\text{V}$	88	109		88	109		dB
Output Voltage Swing	V_{OUT}	$R_L = 5\text{k}\Omega$	± 11.0	± 13.5		± 11.0	± 13.5		V
Supply Current per Amplifier	I_S			19	30		19	30	μA

Note 1: Guaranteed by design.

Note 2: Power-supply rejection ratio is measured at the minimum supply voltage. The op amps actually work at 1.7V supply, but with additional input offset-voltage skew.

17 μ A Max, Dual/Quad, Single-Supply, Precision Op Amps

Typical Operating Characteristics

MAX478/MAX479

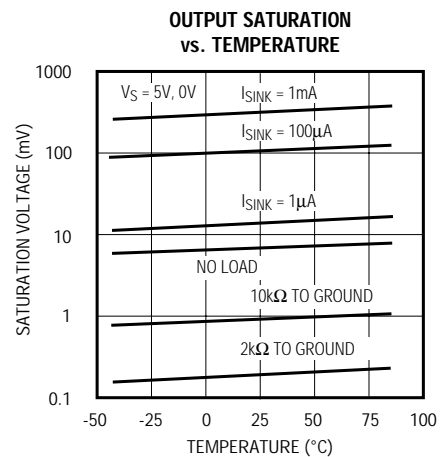
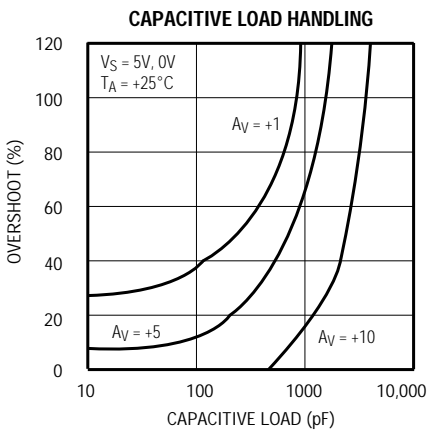
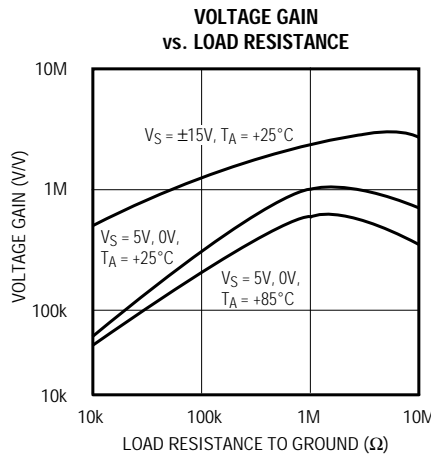
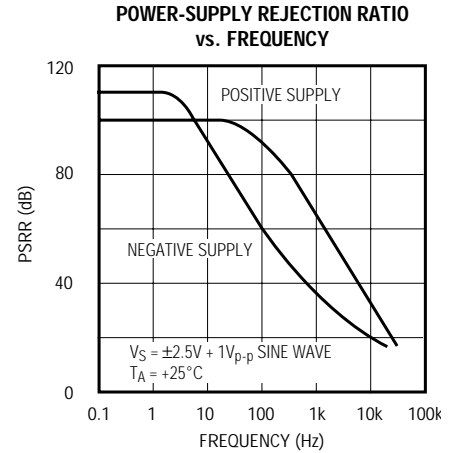
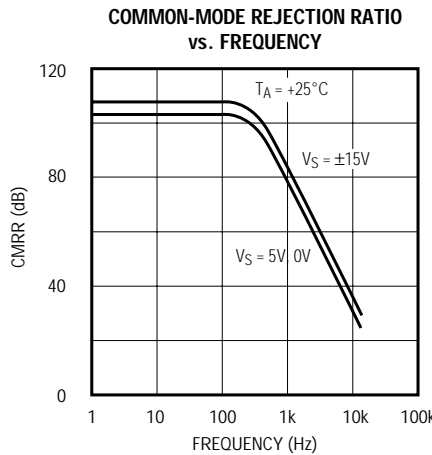
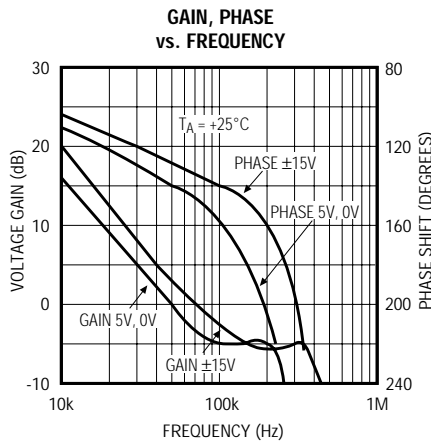
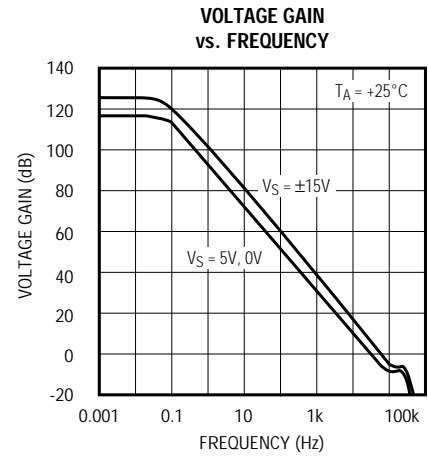
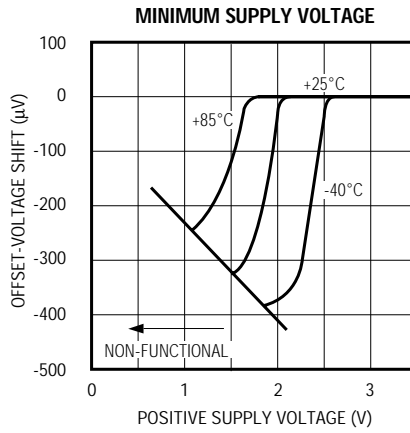
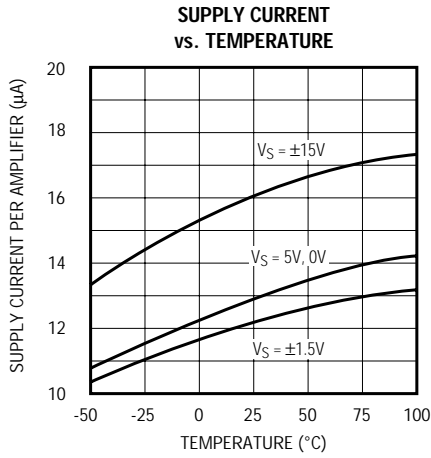

17 μ A Max, Dual/Quad, Single-Supply, Precision Op Amps

Typical Operating Characteristics (continued)

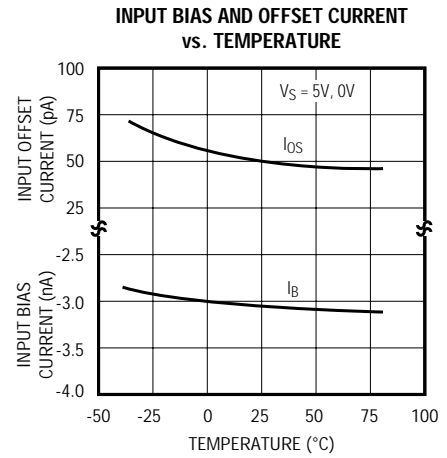
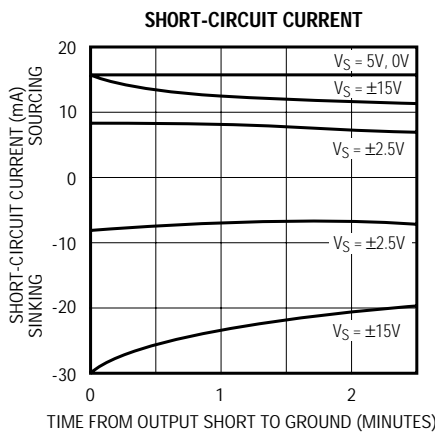
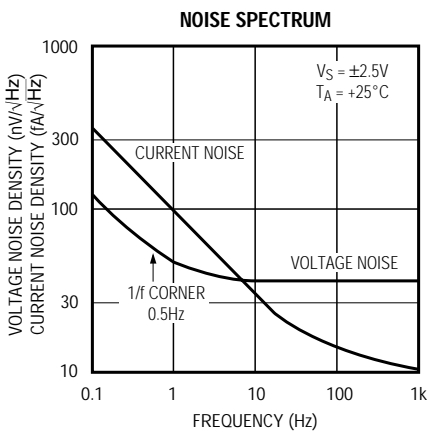

LARGE-SIGNAL TRANSIENT RESPONSE
 $V_S = \pm 15V$

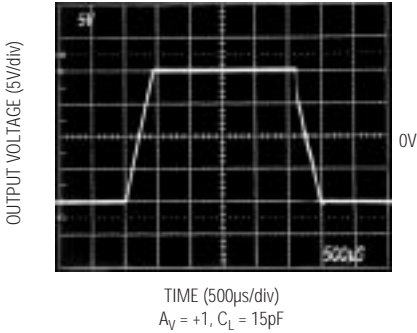

LARGE-SIGNAL TRANSIENT RESPONSE
 $V_S = 5V, 0V$

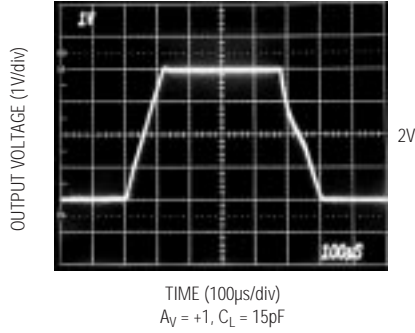

SMALL-SIGNAL TRANSIENT RESPONSE
 $V_S = \pm 2.5V$

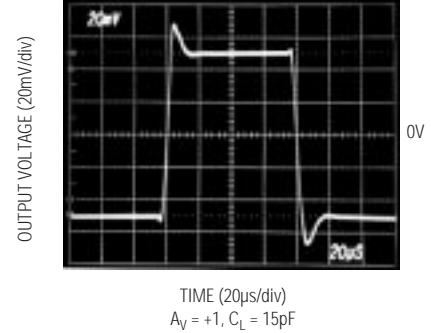

SMALL-SIGNAL TRANSIENT RESPONSE
 $V_S = 5V, 0V$

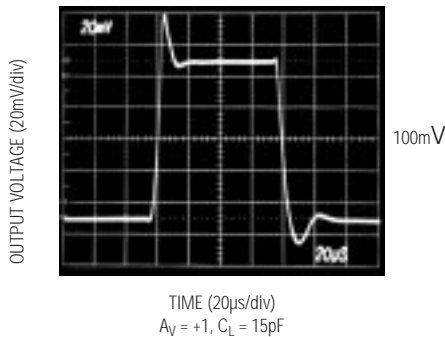

SMALL-SIGNAL TRANSIENT RESPONSE
 $V_S = \pm 15V$

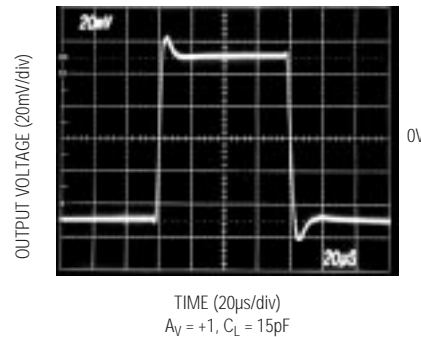

17µA Max, Dual/Quad, Single-Supply, Precision Op Amps

MAX478/MAX479

Typical Application Circuit

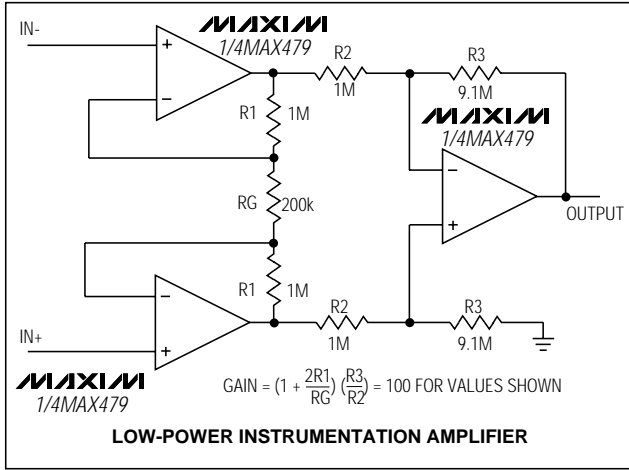

Chip Topography

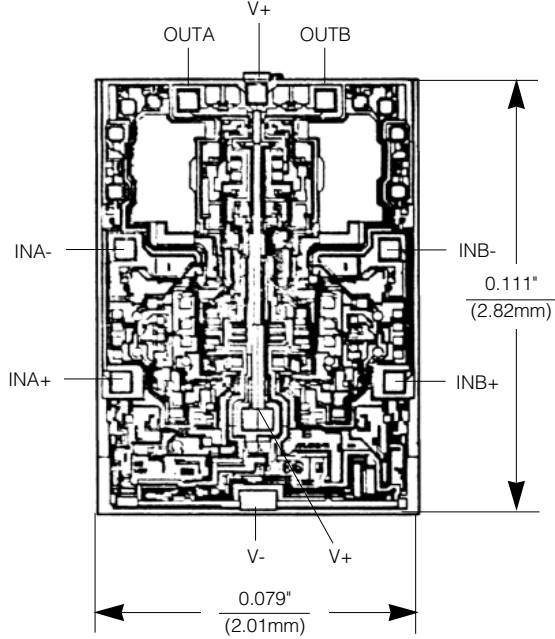

Package Information

	INCHES		MILLIMETERS	
	MIN	MAX	MIN	MAX
A	0.053	0.069	1.35	1.75
A1	0.004	0.010	0.10	0.25
B	0.014	0.019	0.35	0.49
C	0.007	0.010	0.19	0.25
e	0.050		1.27	
E	0.150	0.157	3.80	4.00
H	0.228	0.244	5.80	6.20
h	0.010	0.020	0.25	0.50
L	0.016	0.050	0.40	1.27

	INCHES		MILLIMETERS		N	MS012
	MIN	MAX	MIN	MAX		
D	0.189	0.197	4.80	5.00	8	A
D	0.337	0.344	8.55	8.75	14	B
D	0.386	0.394	9.80	10.00	16	C

NOTES:
 1. D&E DO NOT INCLUDE MOLD FLASH
 2. MOLD FLASH OR PROTRUSIONS NOT TO EXCEED .15mm (.006")
 3. LEADS TO BE COPLANAR WITHIN .102mm (.004")
 4. CONTROLLING DIMENSION: MILLIMETER
 5. MEETS JEDEC MS012-XX AS SHOWN IN ABOVE TABLE
 6. N = NUMBER OF PINS

MAXIM PACKAGE FAMILY OUTLINE: SOIC .150" 1/1 21-0041 A

17µA Max, Dual/Quad, Single-Supply, Precision Op Amps

Package Information (continued)

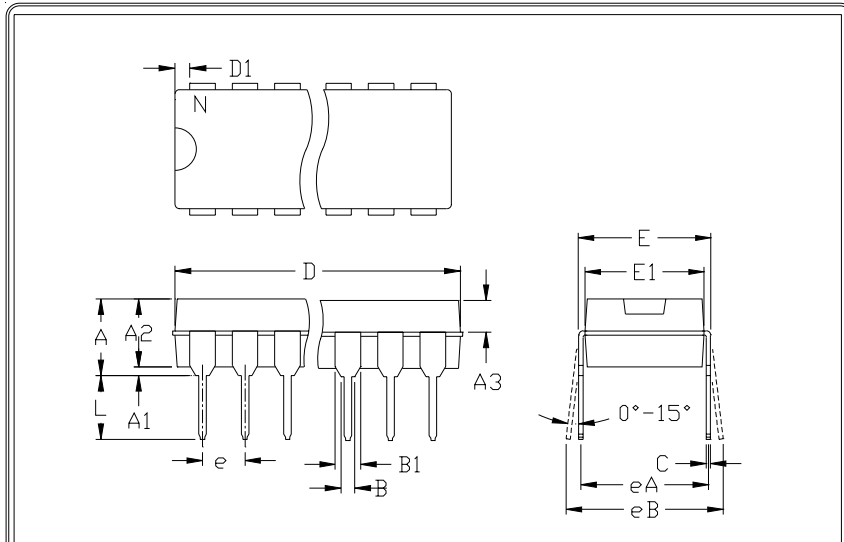

	INCHES		MILLIMETERS	
	MIN	MAX	MIN	MAX
A	---	0.200	---	5.08
A1	0.015	---	0.38	---
A2	0.125	0.175	3.18	4.45
A3	0.055	0.080	1.40	2.03
B	0.016	0.022	0.41	0.56
B1	0.045	0.065	1.14	1.65
C	0.008	0.012	0.20	0.30
D1	0.005	0.080	0.13	2.03
E	0.300	0.325	7.62	8.26
E1	0.240	0.310	6.10	7.87
e	0.100	---	2.54	---
eA	0.300	---	7.62	---
eB	---	0.400	---	10.16
L	0.115	0.150	2.92	3.81

	INCHES		MILLIMETERS		N	MS001
	MIN	MAX	MIN	MAX		
D	0.348	0.390	8.84	9.91	8	AB
D	0.735	0.765	18.67	19.43	14	AC
D	0.745	0.765	18.92	19.43	16	AA
D	0.885	0.915	22.48	23.24	18	AD
D	1.015	1.045	25.78	26.54	20	AE
D	1.14	1.265	28.96	32.13	24	AF
D	1.360	1.380	34.54	35.05	28	*5

- NOTES:
 1. D&E DO NOT INCLUDE MOLD FLASH
 2. MOLD FLASH OR PROTRUSIONS NOT TO EXCEED .15mm (.006")
 3. CONTROLLING DIMENSION: MILLIMETER
 4. MEETS JEDEC MS001-XX AS SHOWN IN ABOVE TABLE
 5. SIMILAR TO JEDEC MO-058AB
 6. N = NUMBER OF PINS

MAXIM PACKAGE FAMILY OUTLINE: PDIP .300" $\frac{1}{1}$ 21-0043 A
120 SAN GABRIEL DR. SUNNYVALE, CA 94086 FAX (408) 737-7794 PROPRIETARY INFORMATION TITLE DOCUMENT CONTROL NUMBER REV

Maxim cannot assume responsibility for use of any circuitry other than circuitry entirely embodied in a Maxim product. No circuitry patent licenses are implied. Maxim reserves the right to change the circuitry and specifications without notice at any time.

12 Maxim Integrated Products, 120 San Gabriel Drive, Sunnyvale, CA 94086 408-737-7600

Mouser Electronics

Authorized Distributor

Click to View Pricing, Inventory, Delivery & Lifecycle Information:

Maxim Integrated:

[MAX479ACPD](#) [MAX479CPD](#) [MAX479CPD+](#) [MAX479CSD+](#) [MAX479CSD+T](#) [MAX479CSD-T](#) [MAX479EPD](#)
[MAX479EPD+](#) [MAX479ESD+](#) [MAX479ESD+T](#) [MAX479ESD-T](#) [MAX478ACPA](#) [MAX478ACPA+](#) [MAX478CPA](#)
[MAX478CPA+](#) [MAX478CSA](#) [MAX478CSA+](#) [MAX478CSA+T](#) [MAX478CSA-T](#) [MAX478EPA](#) [MAX478EPA+](#)
[MAX478ESA](#) [MAX478ESA+](#) [MAX478ESA+T](#) [MAX478ESA-T](#) [MAX478C/D](#) [MAX479CSD](#) [MAX479ESD](#)