

REVISION AQ

TABLE 2	
OPTION	CONTACTS
-T	T-1S7-XX-T (XDMX)
	C-10-T (IDSX)
-C***	T-1S7-XX-T (XDMX)
	C-10-G (IDSX)
-A***	T-1S7-XX-G (XDMX)
	C-10-T (IDSX)

***CAN ONLY BE USED WITH CONNECTOR SPECIFICATION -T

PLATING
-T, -C*** OR -A***

SUBSTITUTE GRAY CABLE FOR STANDARD COLOR CODED CABLE.

XDMD: CB-XX-28-7/36-050-G
XDMS: CB-XX-28-7/36-100-G
(SEE FIG 1)

NOTE: USE GRAY CABLE FOR DOUBLE ROW, -31 & -32 POSITION.

-G
GRAY CABLE

NOTE:

- CONDUCTORS SHALL BE CONSISTENT IN APPEARANCE. SOLDER MUST MAINTAIN CABLE STRAINS WITHIN THE MAX DIA. TOLERANCE.
- USE 60/40 TIN/LEAD SOLDER ONLY.
- NOT AVAILABLE IN 28 POSITION AND UP IN DOUBLE ROW ONLY.

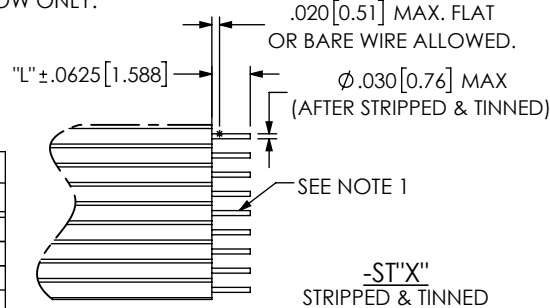
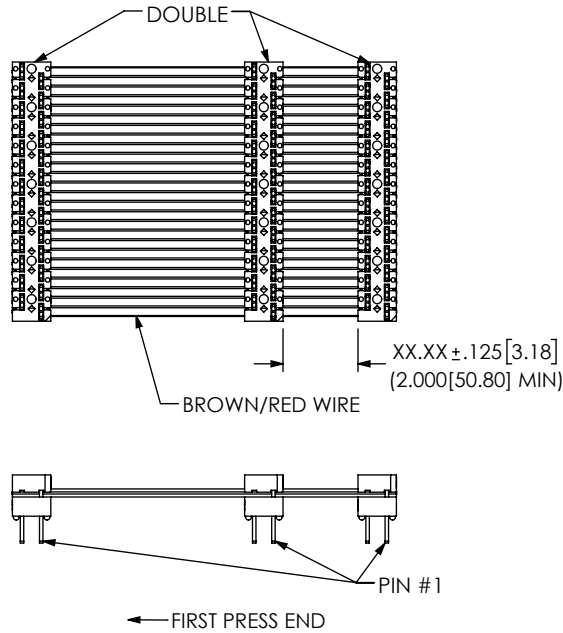
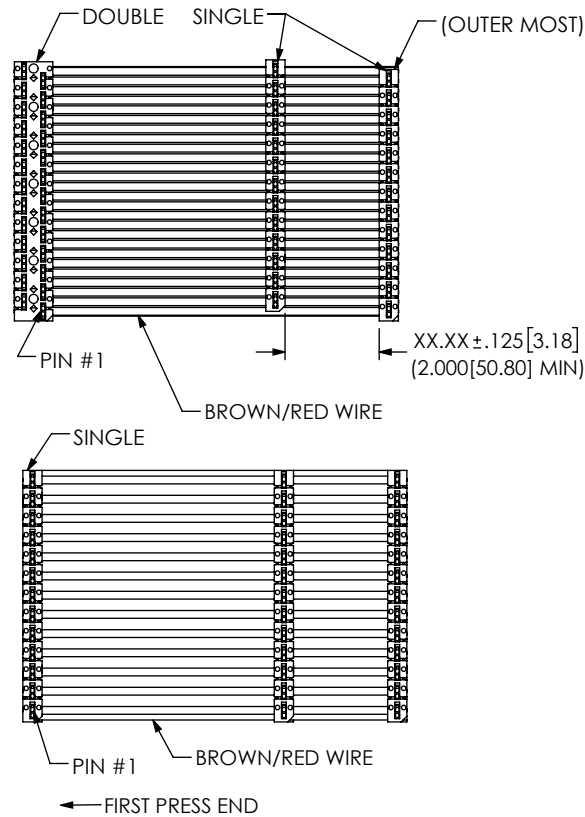
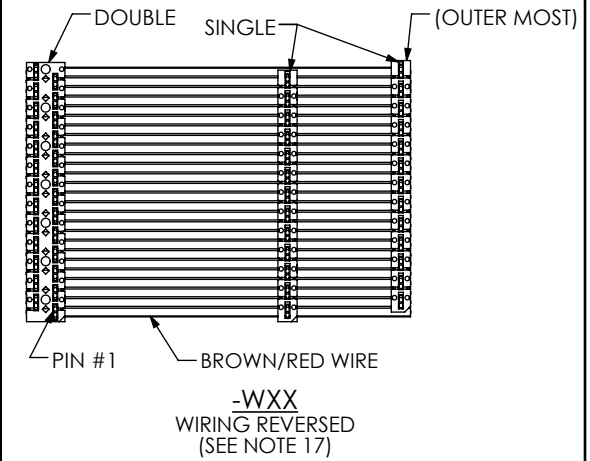

TABLE 3	
ST "X"	"L"
ST8	.125 [3.18]
ST4	.250 [6.35]
ST3	.375 [9.53]
ST2	.500 [12.70]

-ST"X"
STRIPPED & TINNED



-DXX
DAISY CHAIN - DOUBLE

2 INCH MINIMUM LENGTH;
ONE INCH INCREMENTS ONLY

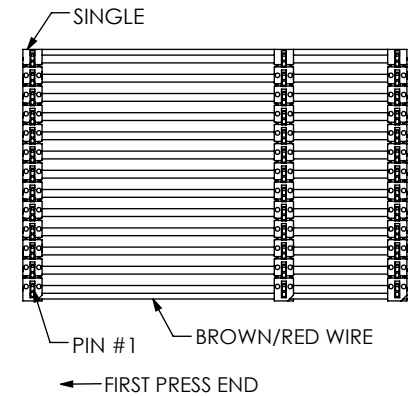

-SXX
DAISY CHAIN - SINGLE
(SEE NOTE 2 & 8)

2 INCH MINIMUM LENGTH;
ONE INCH INCREMENTS ONLY

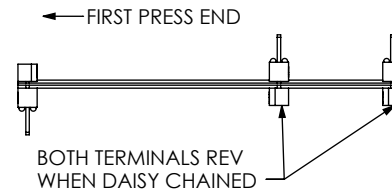

SINGLE ROW

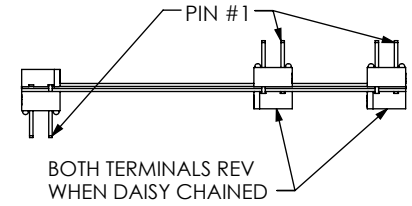
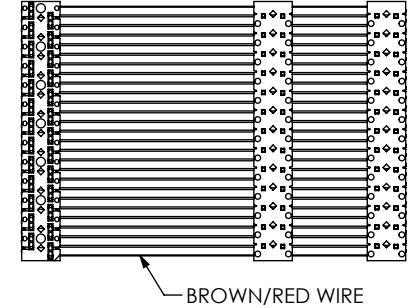

DOUBLE ROW

-R
REVERSED CONNECTOR
(NOT AVAILABLE WITH -M OR -O OPTIONS)

PROPRIETARY NOTE
THIS DOCUMENT CONTAINS CONFIDENTIAL AND PROPRIETARY INFORMATION AND ALL DESIGN, MANUFACTURING, REPRODUCTION, USE, PATENT RIGHTS AND SALES RIGHTS ARE EXPRESSLY RESERVED BY SAMTEC, INC. THIS DOCUMENT SHALL NOT BE DISCLOSED, IN WHOLE OR PART, TO ANY UNAUTHORIZED PERSON OR ENTITY NOR REPRODUCED, TRANSFERRED OR INCORPORATED IN ANY OTHER PROJECT IN ANY MANNER WITHOUT THE EXPRESS WRITTEN CONSENT OF SAMTEC, INC.



520 PARK EAST BLVD, NEW ALBANY, IN 47150
PHONE: 812-944-6733 FAX: 812-948-5047
e-Mail: info@SAMTEC.com code 55322

DO NOT SCALE DRAWING

SHEET SCALE: 2:1

DESCRIPTION:
ASSEMBLY INSULATION DISPLACEMENT TERMINAL CONNECTOR

DWG. NO.
XDMX-XX-X-XX.XX-XXX-XXX

BY: JORDAN 12/30/1987 SHEET 2 OF 3

REVISION AQ

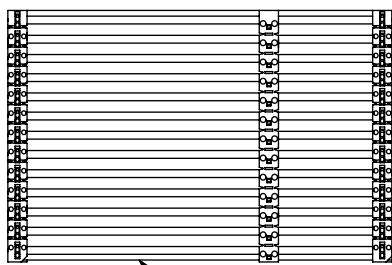

BROWN/RED WIRE

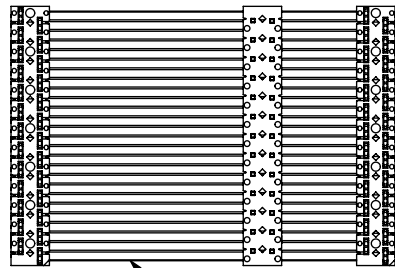

BROWN/RED WIRE

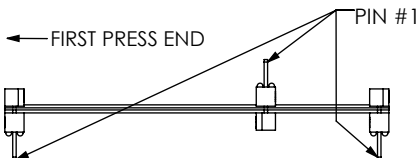

SINGLE ROW

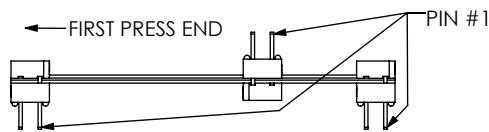

DOUBLE ROW

-M
MIDDLE REVERSED
(REQUIRES -SXX, -WXX OR -DXX OPTIONS)
(NOT AVAILABLE WITH -R OR -O OPTIONS)

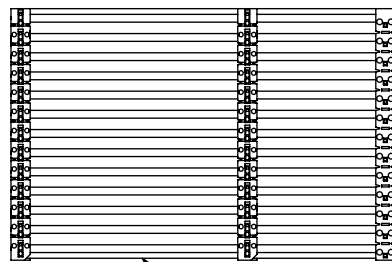

BROWN/RED WIRE

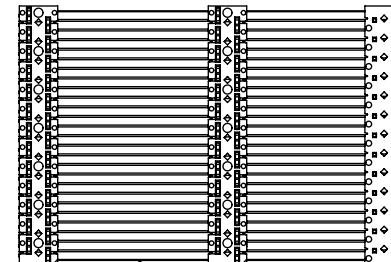

BROWN/RED WIRE

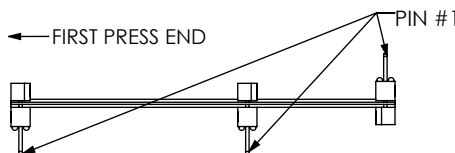

SINGLE ROW

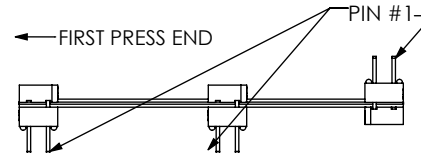

DOUBLE ROW

-O
OUTSIDE REVERSED
(REQUIRES -SXX, -WXX OR -DXX OPTIONS)
(NOT AVAILABLE WITH -R OR -M OPTIONS)

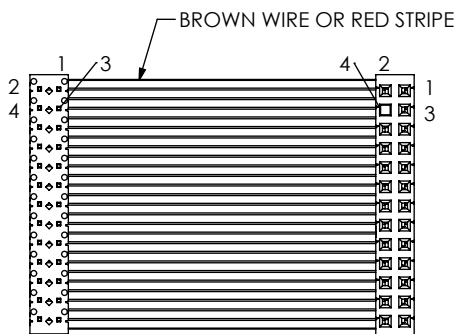

IDMD IDSD



-PXX
POLARIZED MATING (SEE NOTE 7)
(XX = POSITION NO.)
(NOT AVAILABLE WITH -R OR -M OPTIONS)

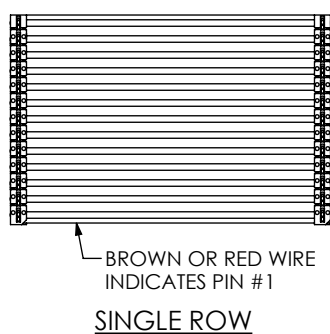

SINGLE ROW

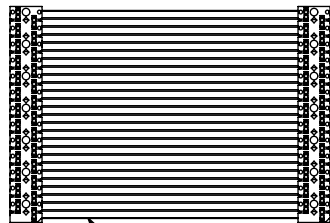

DOUBLE ROW

STANDARD WIRING

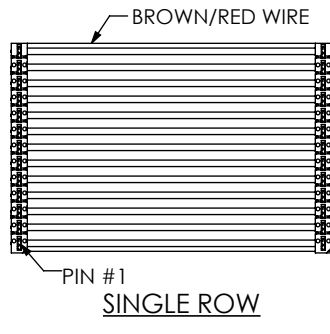

SINGLE ROW

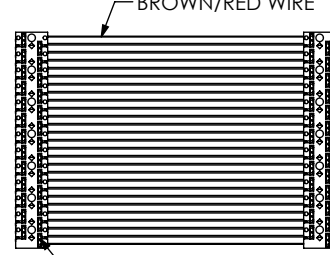

DOUBLE ROW

-RW
REVERSED WIRING

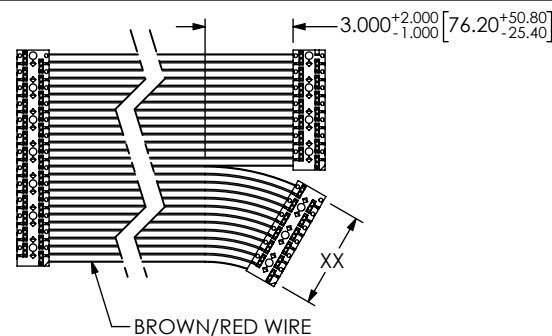

-BXX
BREAKOUT

XDMS-XX-T-XX-BXX:
XX INDICATES NO. OF POSITIONS
XDMD-XX-D-XX-BXX:
XX INDICATES NO. OF CONDUCTORS
XDMD-XX-S-XX-BXX:
XX INDICATES NO. OF CONDUCTORS
XDMS-XX-D-XX-BXX:
XX INDICATES NO. OF POSITIONS
XDMS-XX-S-XX-BXX:
XX INDICATES NO. OF POSITIONS

PROPRIETARY NOTE
THIS DOCUMENT CONTAINS CONFIDENTIAL AND PROPRIETARY INFORMATION AND ALL DESIGN, MANUFACTURING, REPRODUCTION, USE, PATENT RIGHTS AND SALES RIGHTS ARE EXPRESSLY RESERVED BY SAMTEC, INC. THIS DOCUMENT SHALL NOT BE DISCLOSED, IN WHOLE OR PART, TO ANY UNAUTHORIZED PERSON OR ENTITY NOR REPRODUCED, TRANSFERRED OR INCORPORATED IN ANY OTHER PROJECT IN ANY MANNER WITHOUT THE EXPRESS WRITTEN CONSENT OF SAMTEC, INC.



520 PARK EAST BLVD, NEW ALBANY, IN 47150
PHONE: 812-944-6733 FAX: 812-948-5047
e-Mail: info@SAMTEC.com code 55322

DO NOT SCALE DRAWING

SHEET SCALE: 1:1

DESCRIPTION:
ASSEMBLY INSULATION DISPLACEMENT TERMINAL CONNECTOR

DWG. NO.
XDMX-XX-X-XX.XX-XXX-XXX

BY: JORDAN 12/30/1987 SHEET 3 OF 3

NOTE:
1. INSERT POLARIZING KEY PART NO. PK-06 INTO SPECIFIED POSITION -XX OF IDS END OF -T (TRANSFER) END ONLY.
2. POLARIZED POSITION WILL HAVE SAME ELECTRICAL POSITION FROM BROWN WIRE.

Mouser Electronics

Authorized Distributor

Click to View Pricing, Inventory, Delivery & Lifecycle Information:

Samtec:

[IDMS-06-S-04.00-T-ST4](#) [IDMD-03-T-02.00-A-R](#) [IDMD-03-T-02.00-T-R](#) [IDMD-04-T-02.00-T-G-R](#) [IDMD-05-T-06.00-T-G-R](#) [IDMD-05-T-12.00-T-G-R](#) [IDMD-08-T-02.00-T-R](#) [IDMD-02-S-10.00](#) [IDMD-02-D-20.00](#) [IDMS-16-T-16.00](#) [IDMS-32-T-15.00-G](#) [IDMD-10-S-05.00-T-G](#) [IDMS-03-T-04.00-T](#) [IDMS-13-D-06.00](#) [IDMD-06-T-10.00-A](#) [IDMD-07-T-05.00-G-R](#) [IDMS-07-T-20.00](#) [IDMD-09-D-02.00-T](#) [IDMD-32-D-11.00-G](#) [IDMD-32-T-04.00-A-G](#) [IDMS-04-D-02.00-T-G](#) [IDMD-07-T-07.00-G](#) [IDMD-10-D-09.00-T-G](#) [IDMD-20-T-15.00](#) [IDMD-32-D-12.00-T-G](#) [IDMD-32-T-06.00-G-R](#) [IDMD-32-T-10.00-T-G](#) [IDMS-04-S-02.00](#) [IDMS-16-S-02.00](#) [IDMD-03-T-02.00-T](#) [IDMD-20-S-17.00-G-T](#) [IDMD-08-T-06.00-T-R](#) [IDMD-32-D-04.00-G](#) [IDMS-04-T-04.00-C](#)