

Contents

- 1 Block diagram and application circuit 5**
 - 1.1 Block diagram 5
 - 1.2 Standard test and application circuit 5

- 2 Pin description 6**

- 3 Electrical specifications 7**
 - 3.1 Absolute maximum ratings 7
 - 3.2 Thermal data 7
 - 3.3 Electrical characteristics 8
 - 3.4 Electrical characteristic curves 11

- 4 Application hints 14**
 - 4.1 SVR 14
 - 4.2 Input stage 14
 - 4.3 Standby and muting 14
 - 4.4 DC offset detector 14
 - 4.5 Heatsink definition 14

- 5 Package information 15**

- 6 Revision history 17**

List of tables

Table 1.	Device summary	1
Table 2.	Absolute maximum ratings	7
Table 3.	Thermal data	7
Table 4.	Electrical characteristics	8
Table 5.	Document revision history	17

List of figures

Figure 1.	Block diagram	5
Figure 2.	Standard test and application circuit	5
Figure 3.	Pin connection (top view)	6
Figure 4.	Components and top copper layer of the <i>Figure 2.</i>	10
Figure 5.	Bottom copper layer <i>Figure 2.</i>	10
Figure 6.	Quiescent current vs. supply voltage	11
Figure 7.	Output power vs. supply voltage ($R_L = 4\Omega$)	11
Figure 8.	Output power vs. supply voltage ($R_L = 2\Omega$)	11
Figure 9.	Distortion vs. output power ($R_L = 4\Omega$)	11
Figure 10.	Distortion vs. output power ($R_L = 2\Omega$)	11
Figure 11.	Distortion vs. frequency ($R_L = 4\Omega$)	11
Figure 12.	Distortion vs. frequency ($R_L = 2\Omega$)	12
Figure 13.	Crosstalk vs. frequency	12
Figure 14.	Supply voltage rejection vs. frequency	12
Figure 15.	Output attenuation vs. supply voltage	12
Figure 16.	Power dissipation and efficiency vs. output power ($R_L = 4\Omega$, SINE)	12
Figure 17.	Power dissipation and efficiency vs. output power ($R_L = 2\Omega$, SINE)	12
Figure 18.	Power dissipation vs. output power ($R_L = 4\Omega$, audio program simulation)	13
Figure 19.	Power dissipation vs. output power ($R_L = 2\Omega$, audio program simulation)	13
Figure 20.	ITU R-ARM frequency response, weighting filter for transient pop.	13
Figure 21.	Flexiwatt25 (vertical) mechanical data and package dimensions	15
Figure 22.	Flexiwatt25 (horizontal) mechanical data and package dimensions	16

1 Block diagram and application circuit

1.1 Block diagram

Figure 1. Block diagram

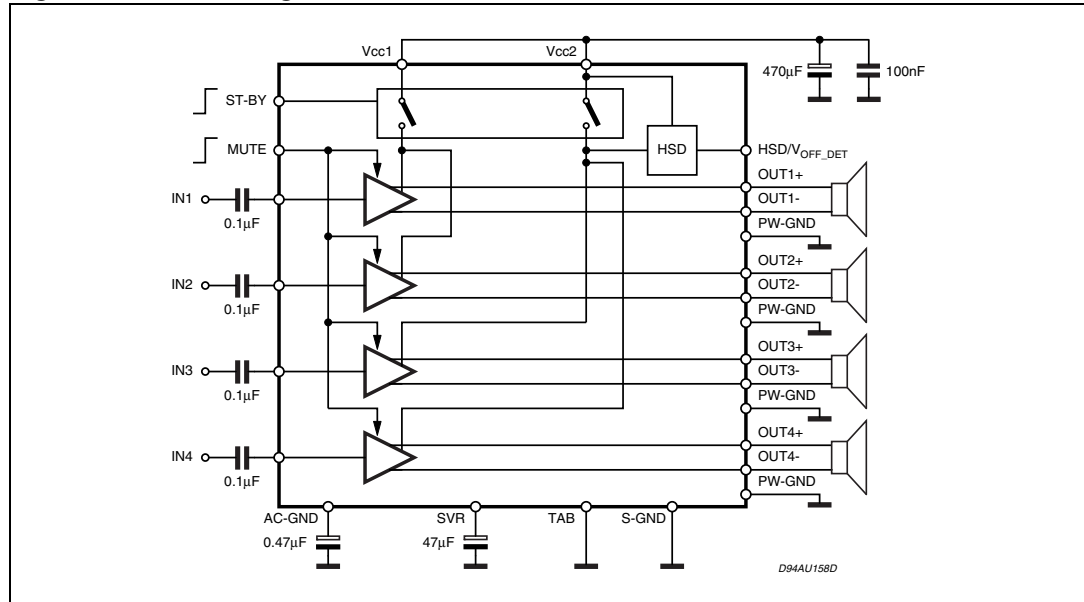

1.2 Standard test and application circuit

Figure 2. Standard test and application circuit

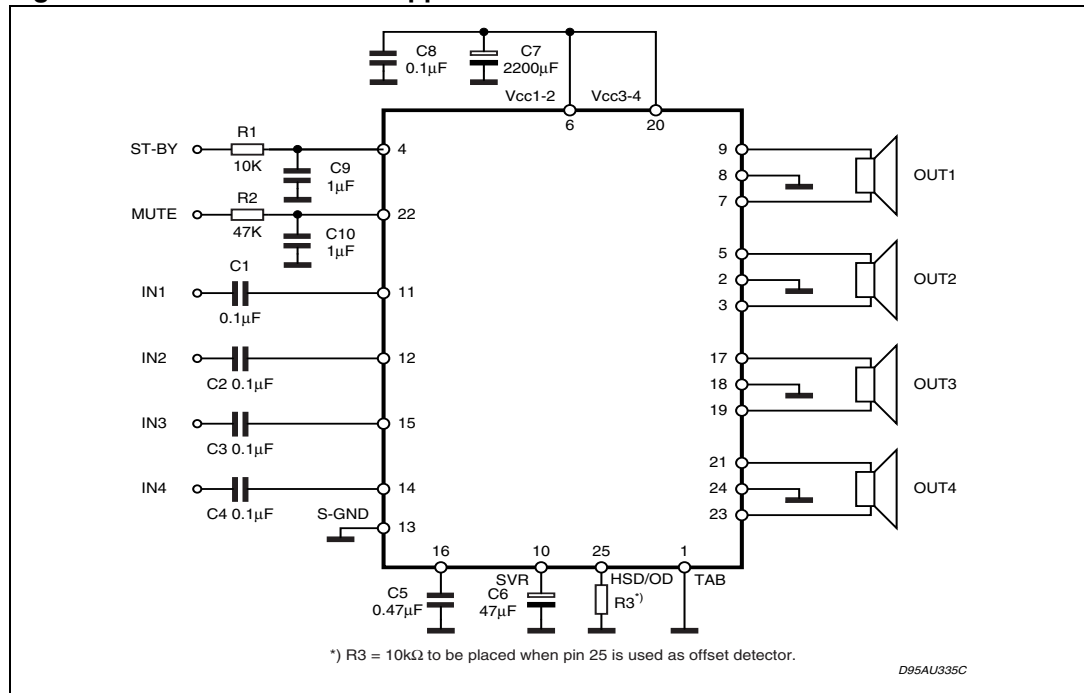

2 Pin description

Figure 3. Pin connection (top view)

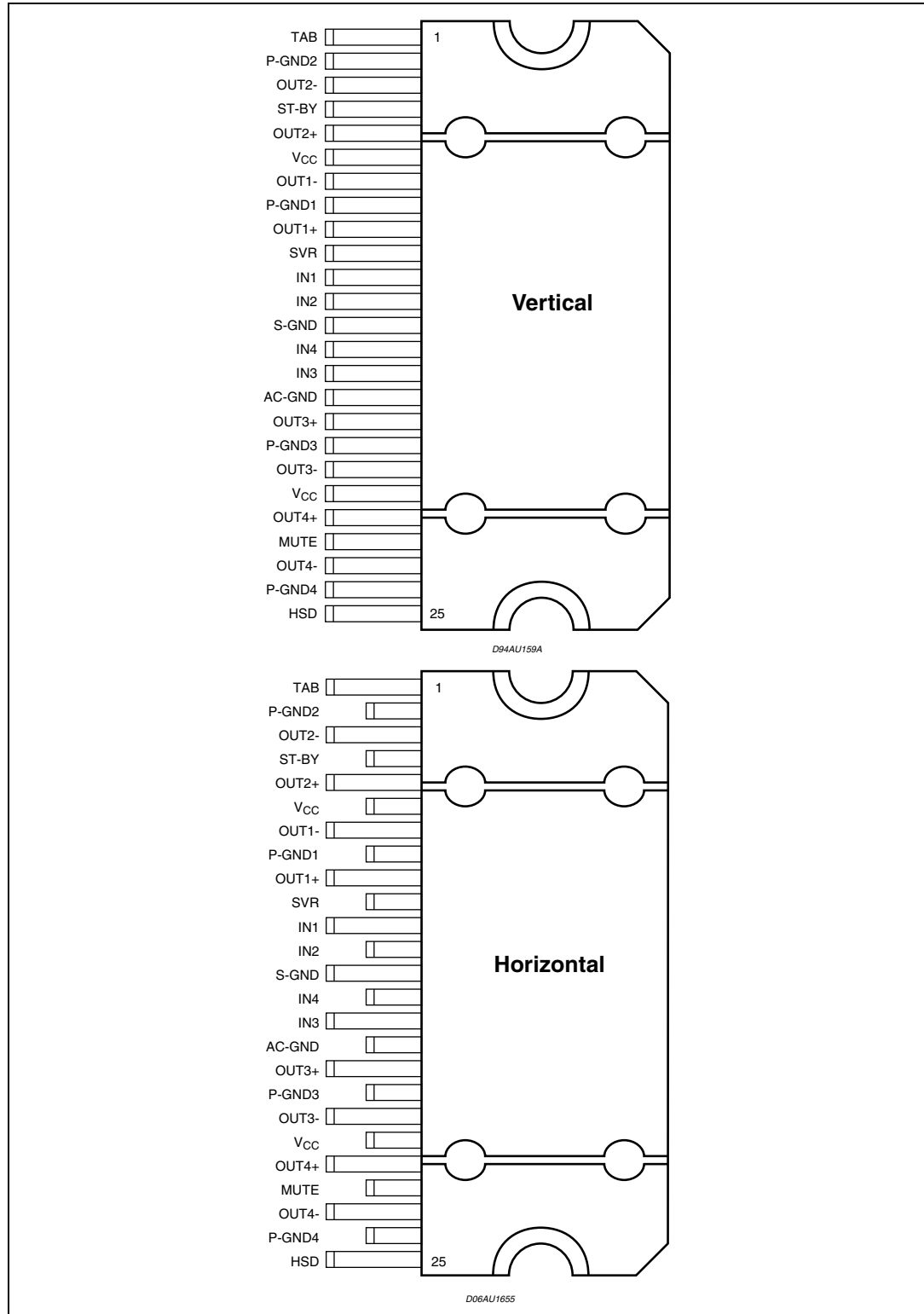

3 Electrical specifications

3.1 Absolute maximum ratings

Table 2. Absolute maximum ratings

Symbol	Parameter	Value	Unit
V_S	Operating supply voltage	18	V
$V_{S(DC)}$	DC supply voltage	28	V
$V_{S(pk)}$	Peak supply voltage (for $t = 50$ ms)	50	V
I_O	Output peak current repetitive (duty cycle 10 % at $f = 10$ Hz) non repetitive ($t = 100$ μ s)	9	A
		10	A
P_{tot}	Power dissipation $T_{case} = 70$ °C	80	W
T_j	Junction temperature	150	°C
T_{stg}	Storage temperature	-55 to 150	°C

3.2 Thermal data

Table 3. Thermal data

Symbol	Parameter	Value	Unit
$R_{th\ j-case}$	Thermal resistance junction to case	Max. 1	°C/W

3.3 Electrical characteristics

Table 4. Electrical characteristics

(Refer to the test and application diagram, $V_S = 14.4\text{ V}$; $R_L = 4\ \Omega$; $R_g = 600\ \Omega$; $f = 1\text{ kHz}$; $T_{\text{amb}} = 25\text{ }^\circ\text{C}$; unless otherwise specified).

Symbol	Parameter	Test condition	Min.	Typ.	Max.	Unit
I_{q1}	Quiescent current	$R_L = \infty$	100	180	280	mA
V_{OS}	Output offset voltage	Play mode / Mute mode			± 50	mV
dV_{OS}	During mute ON/OFF output offset voltage	ITU R-ARM weighted see Figure 20	-10		+10	mV
	During Standby ON/OFF output offset voltage		-10		+10	mV
G_v	Voltage gain		25	26	27	dB
dG_v	Channel gain unbalance				± 1	dB
P_o	Output power	$V_S = 13.2\text{ V}$; THD = 10 %	23	25		W
		$V_S = 13.2\text{ V}$; THD = 1 %	16	19		
		$V_S = 14.4\text{ V}$; THD = 10 %	28	30		
		$V_S = 14.4\text{ V}$; THD = 1 %	20	23		
		$V_S = 14.4\text{ V}$; THD = 10 %, $2\ \Omega$	50	55		W
$P_{o\text{ max.}}$	Max. output power ⁽¹⁾	$V_S = 14.4\text{ V}$; $R_L = 4\ \Omega$ $V_S = 14.4\text{ V}$; $R_L = 2\ \Omega$		50 85		W
THD	Distortion	$P_o = 4\text{ W}$ $P_o = 15\text{ W}$; $R_L = 2\ \Omega$		0.006 0.015	0.02 0.03	%
e_{No}	Output noise	"A" Weighted Bw = 20 Hz to 20 kHz		35 50	50 70	μV
SVR	Supply voltage rejection	$f = 100\text{ Hz}$; $V_r = 1\text{ V}_{\text{rms}}$	50	75		dB
f_{ch}	High cut-off frequency	$P_o = 0.5\text{ W}$	100	300		KHz
R_i	Input impedance		80	100	120	K Ω
C_T	Cross talk	$f = 1\text{ kHz}$ $P_o = 4\text{ W}$ $f = 10\text{ kHz}$ $P_o = 4\text{ W}$	60	70 60	- -	dB
I_{SB}	Standby current consumption	$V_{\text{ST-BY}} = 1.5\text{ V}$			20	μA
		$V_{\text{ST-BY}} = 0\text{ V}$			10	
I_{pin5}	ST-BY pin current	$V_{\text{ST-BY}} = 1.5\text{ V to }3.5\text{ V}$			± 1	μA
$V_{\text{SB out}}$	Standby out threshold voltage	(Amp: ON)	2.75			V
$V_{\text{SB in}}$	Standby in threshold voltage	(Amp: OFF)			1.5	V
A_M	Mute attenuation	$P_{\text{Oref}} = 4\text{ W}$	80	90		dB
$V_{\text{M out}}$	Mute out threshold voltage	(Amp: Play)	3.5			V
$V_{\text{M in}}$	Mute in threshold voltage	(Amp: Mute)			1.5	V

Table 4. Electrical characteristics (continued)

(Refer to the test and application diagram, $V_S = 14.4\text{ V}$; $R_L = 4\ \Omega$; $R_g = 600\ \Omega$; $f = 1\text{ kHz}$; $T_{amb} = 25\text{ }^\circ\text{C}$; unless otherwise specified).

Symbol	Parameter	Test condition	Min.	Typ.	Max.	Unit
$V_{AM\ in}$	V_S automute threshold	(Amp: Mute) $Att \geq 80\text{ dB}$; $P_{Oref} = 4\text{ W}$ (Amp: Play) $Att < 0.1\text{ dB}$; $P_O = 0.5\text{ W}$	6.5	7 7.5	8	V
I_{pin23}	Muting pin current	$V_{MUTE} = 1.5\text{ V}$ (Sourced Current)	7	12	18	μA
		$V_{MUTE} = 3.5\text{ V}$	-5		18	μA
HSD section						
$V_{dropout}$	Dropout voltage	$I_O = 0.35\text{ A}$; $V_S = 9\text{ to }16\text{ V}$		0.25	0.6	V
I_{prot}	Current limits		400		800	mA
Offset detector (Pin 25)						
V_{M_ON}	Mute voltage for DC offset detection enabled	$V_{ST-BY} = 5\text{ V}$	8			V
V_{M_OFF}					6	V
V_{OFF}	Detected differential output offset	$V_{ST-BY} = 5\text{ V}$; $V_{mute} = 8\text{ V}$	± 2	± 3	± 4	V
V_{25_T}	Pin 25 voltage for detection = TRUE	$V_{ST-BY} = 5\text{ V}$; $V_{mute} = 8\text{ V}$ $V_{OFF} > \pm 4\text{ V}$	0		1.5	V
V_{25_F}	Pin 25 Voltage for detection = FALSE	$V_{ST-BY} = 5\text{ V}$; $V_{mute} = 8\text{ V}$ $V_{OFF} > \pm 2\text{ V}$	12			V

1. Saturated square wave output.

Figure 4. Components and top copper layer of the *Figure 2*.

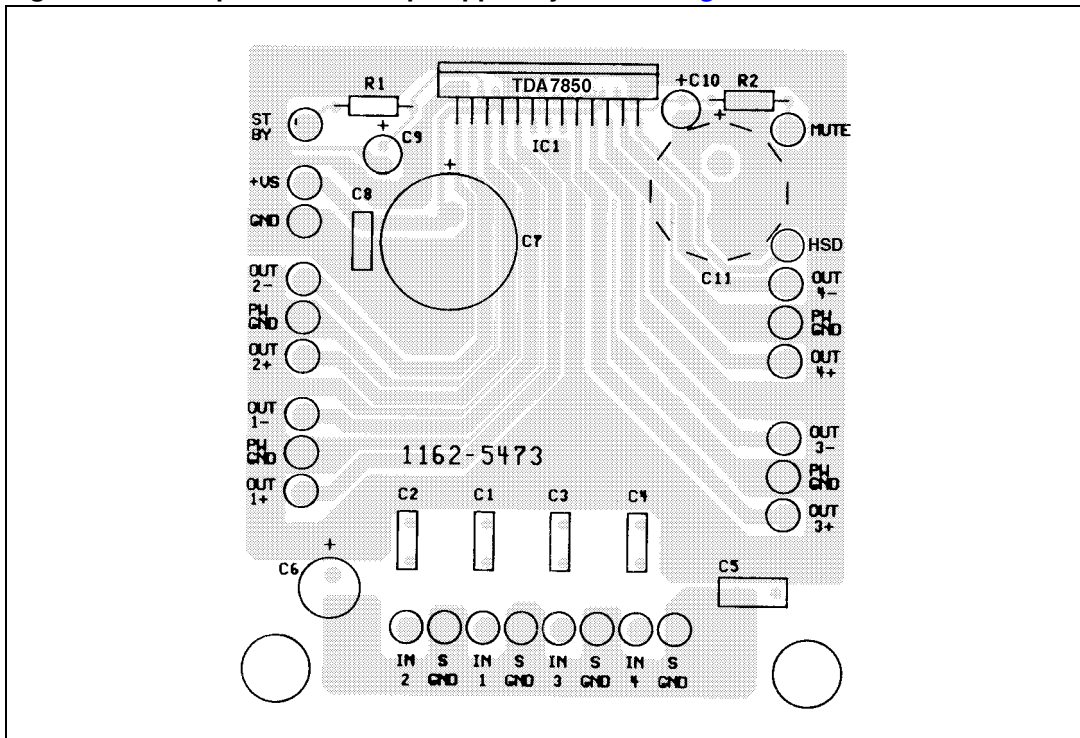
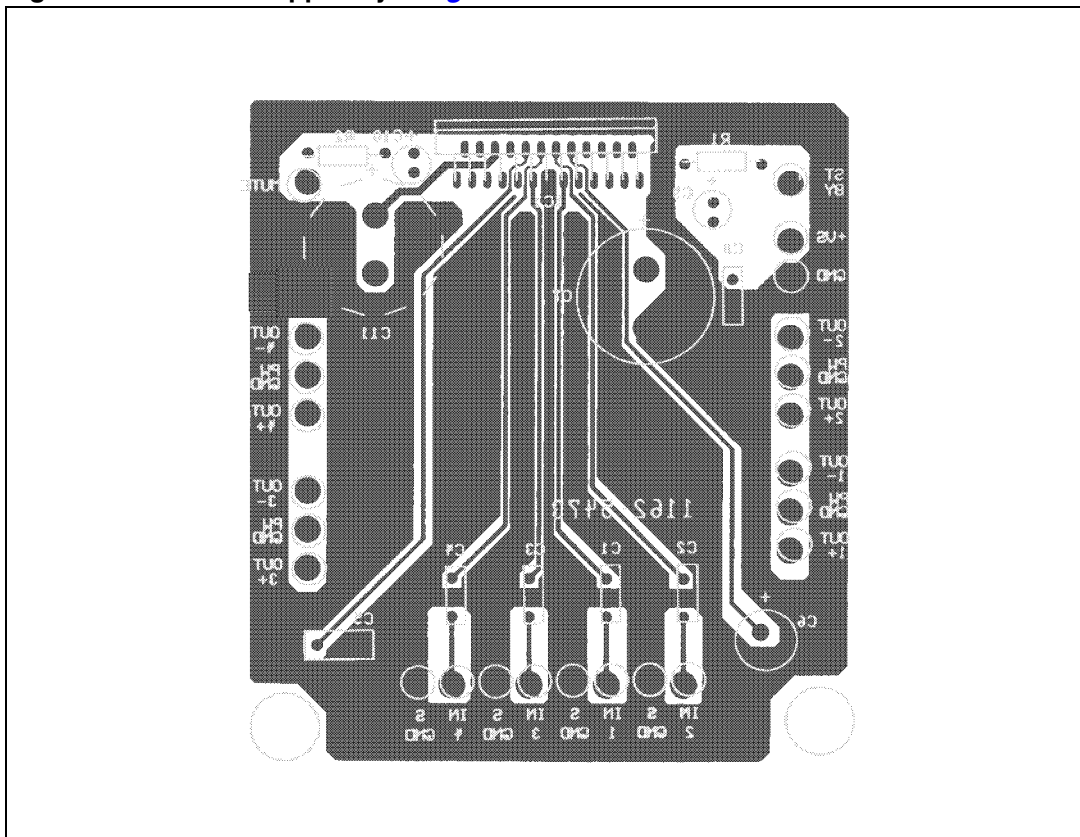

Figure 5. Bottom copper layer *Figure 2*.



3.4 Electrical characteristic curves

Figure 6. Quiescent current vs. supply voltage

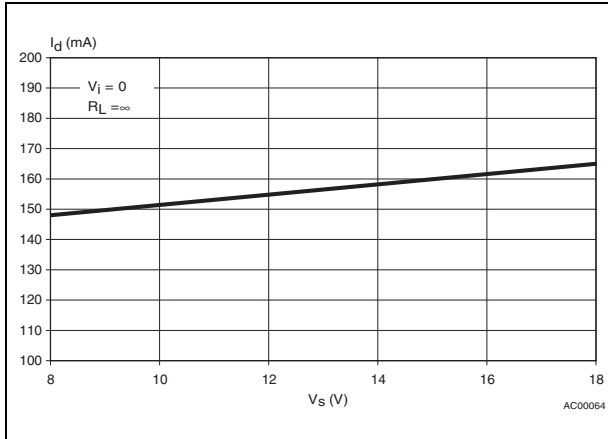

Figure 7. Output power vs. supply voltage (RL = 4Ω)

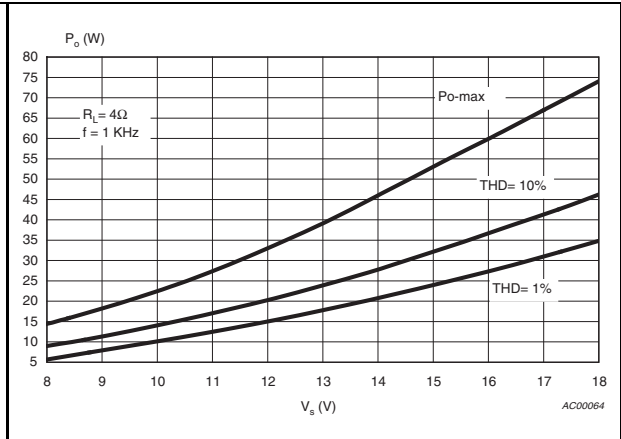

Figure 8. Output power vs. supply voltage (RL = 2Ω)

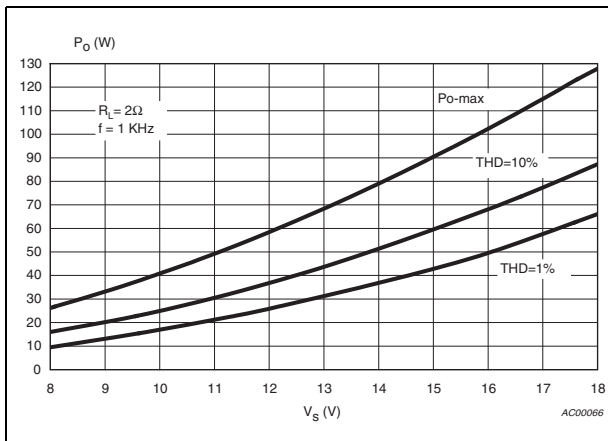

Figure 9. Distortion vs. output power (RL = 4Ω)

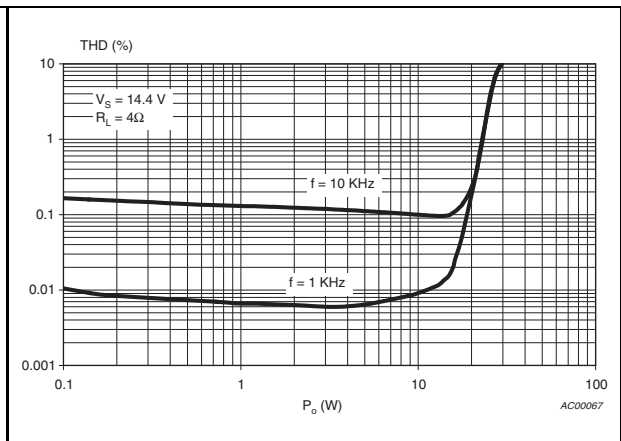

Figure 10. Distortion vs. output power (RL = 2Ω)

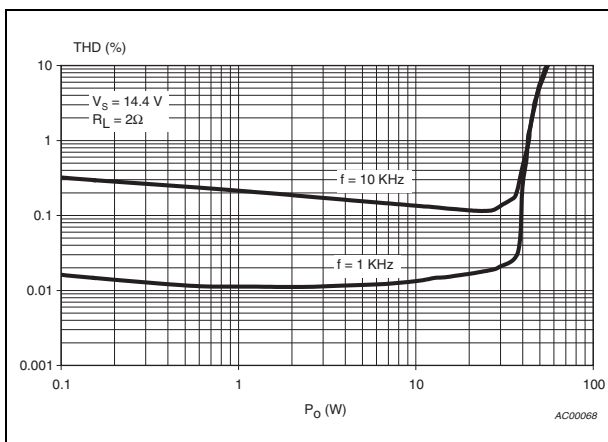

Figure 11. Distortion vs. frequency (RL = 4Ω)

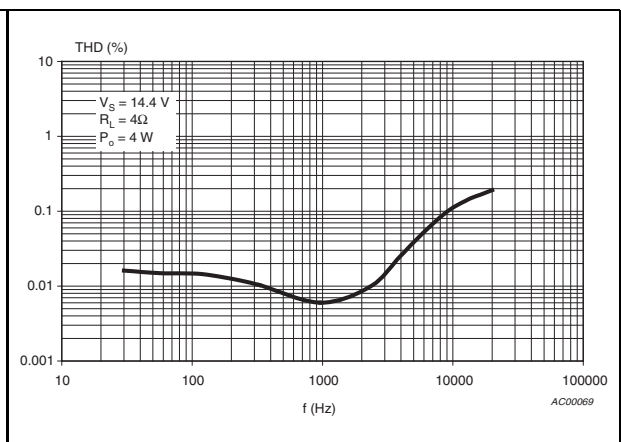

Figure 12. Distortion vs. frequency
($R_L = 2\Omega$)

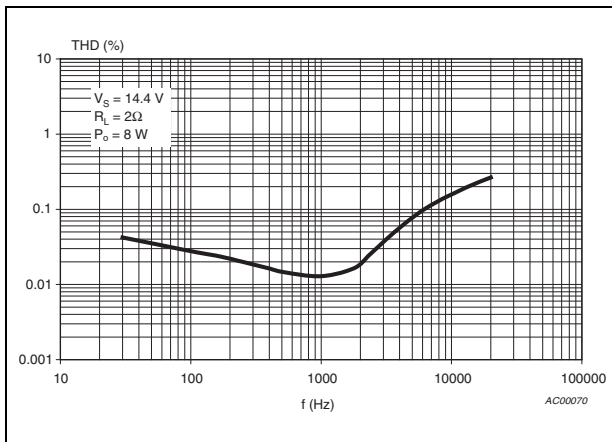

Figure 13. Crosstalk vs. frequency

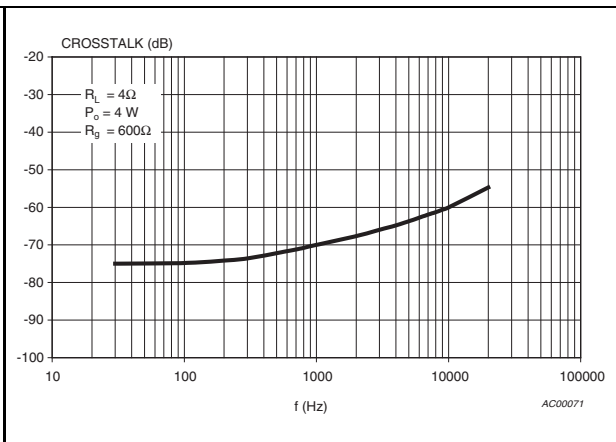

Figure 14. Supply voltage rejection vs. frequency

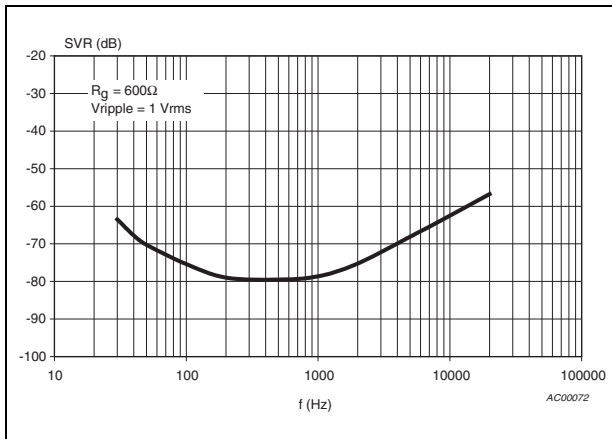

Figure 15. Output attenuation vs. supply voltage

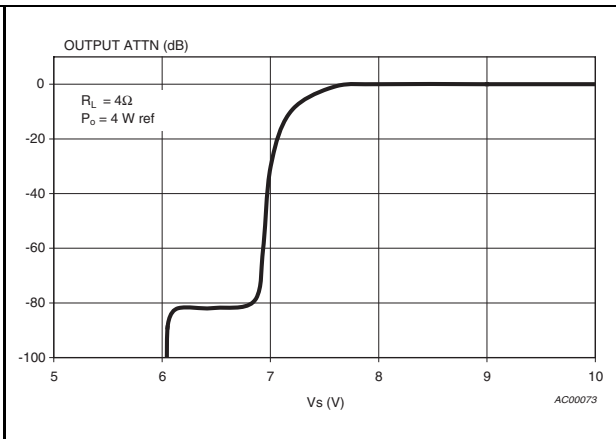

Figure 16. Power dissipation and efficiency vs. output power ($R_L = 4\Omega$, SINE)

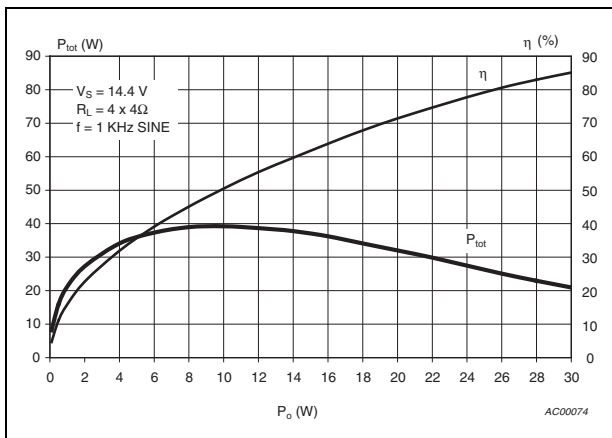

Figure 17. Power dissipation and efficiency vs. output power ($R_L = 2\Omega$, SINE)

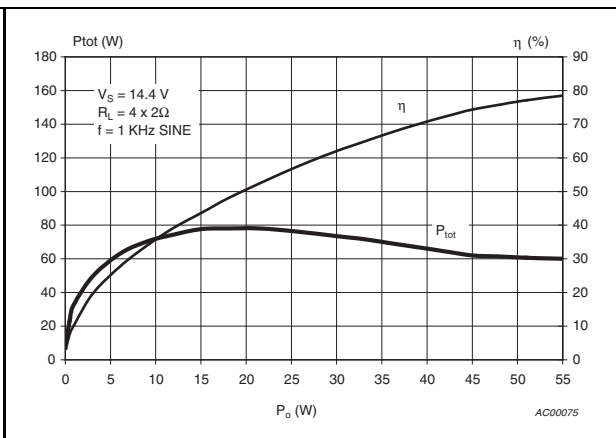

Figure 18. Power dissipation vs. output power ($R_L = 4\Omega$, audio program simulation)

Figure 19. Power dissipation vs. output power ($R_L = 2\Omega$, audio program simulation)

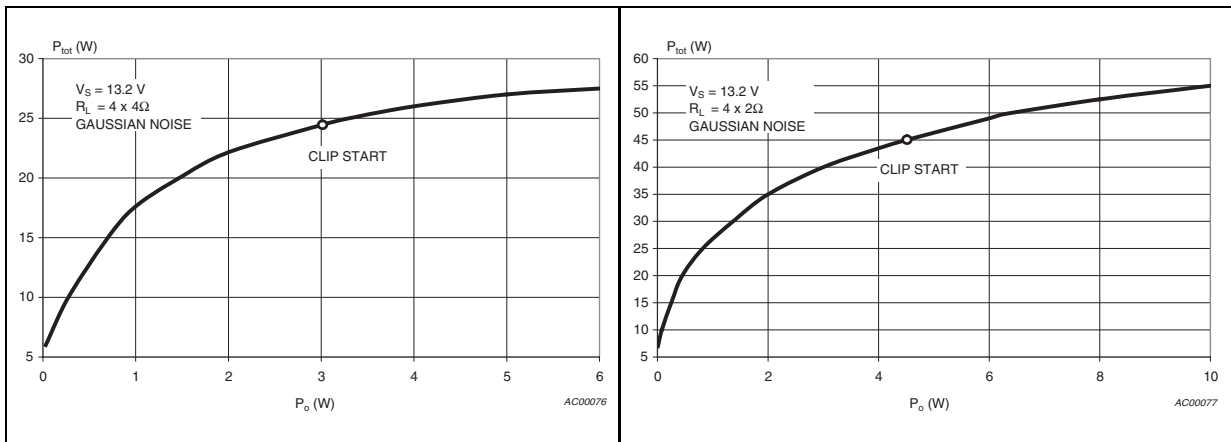
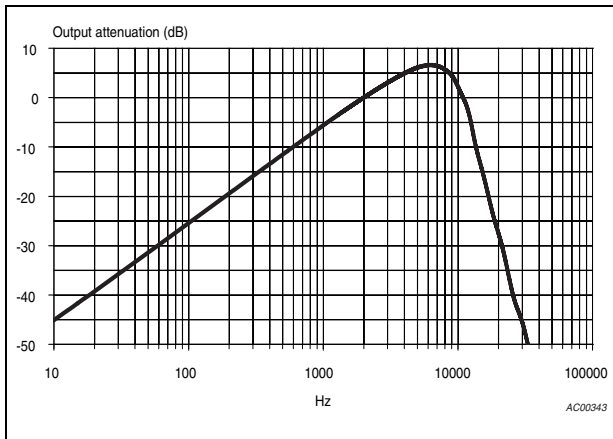

Figure 20. ITU R-ARM frequency response, weighting filter for transient pop



4 Application hints

Referred to the circuit of [Figure 2](#).

4.1 SVR

Besides its contribution to the ripple rejection, the SVR capacitor governs the turn ON/OFF time sequence and, consequently, plays an essential role in the pop optimization during ON/OFF transients. To conveniently serve both needs, **its minimum recommended value is 10 μ F**.

4.2 Input stage

The TDA7850's inputs are ground-compatible and can stand very high input signals (± 8 Vpk) without any performance degradation.

If the standard value for the input capacitors (0.1 μ F) is adopted, the low frequency cut-off will amount to 16 Hz.

4.3 Standby and muting

Standby and Muting facilities are both CMOS compatible. In absence of true CMOS ports or microprocessors, a direct connection to V_s of these two pins is admissible but a 470k Ω equivalent resistance should be present between the power supply and the muting and ST-BY pins.

R-C cells have always to be used in order to smooth down the transitions for preventing any audible transient noises.

About the standby, the time constant to be assigned in order to obtain a virtually pop-free transition has to be slower than 2.5 V/ms.

4.4 DC offset detector

The TDA7850 integrates a DC offset detector to avoid that an anomalous DC offset on the inputs of the amplifier may be multiplied by the gain and result in a dangerous large offset on the outputs which may lead to speakers damage for overheating. The feature is enabled by the MUTE pin (according to table 3) and works with the amplifier unmuted and with no signal on the inputs.

The DC offset detection is signaled out on the HSD pin. To ensure the correct functionality of the Offset Detector it is necessary to connect a pulldown 10 kW resistor between HSD and ground.

4.5 Heatsink definition

Under normal usage (4 Ohm speakers) the heatsink's thermal requirements have to be deduced from [Figure 18](#), which reports the simulated power dissipation when real music/speech programmes are played out. Noise with gaussian-distributed amplitude was employed for this simulation. Based on that, frequent clipping occurrence (worst-case) will cause $P_{diss} = 26$ W. Assuming $T_{amb} = 70$ °C and $T_{CHIP} = 150$ °C as boundary conditions, the heatsink's thermal resistance should be approximately 2°C/W. This would avoid any thermal shutdown occurrence even after long-term and full-volume operation.

5 Package information

In order to meet environmental requirements, ST (also) offers these devices in ECOPACK[®] packages. ECOPACK[®] packages are lead-free. The category of second Level Interconnect is marked on the package and on the inner box label, in compliance with JEDEC Standard JESD97. The maximum ratings related to soldering conditions are also marked on the inner box label.

ECOPACK is an ST trademark. ECOPACK specifications are available at: www.st.com.

Figure 21. Flexiwatt25 (vertical) mechanical data and package dimensions

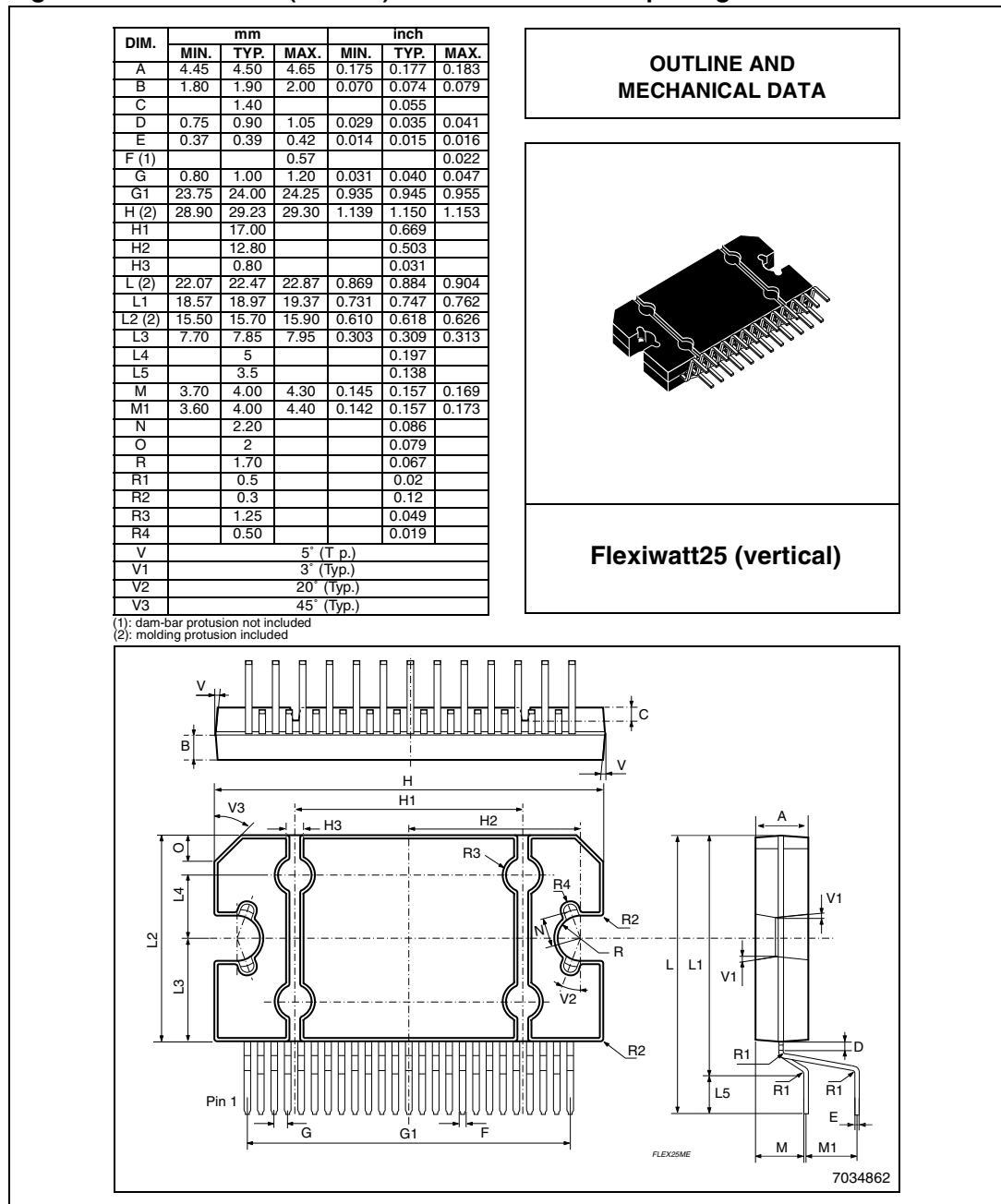
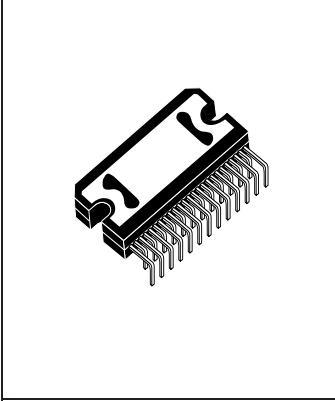

Figure 22. Flexiwatt25 (horizontal) mechanical data and package dimensions

DIM.	mm			inch		
	MIN.	TYP.	MAX.	MIN.	TYP.	MAX.
A	4.45	4.50	4.65	0.175	0.177	0.183
B	1.80	1.90	2.00	0.070	0.074	0.079
C		1.40			0.055	
D		2.00			0.079	
E	0.37	0.39	0.42	0.014	0.015	0.016
F (1)			0.57			0.022
G	0.75	1.00	1.25	0.029	0.040	0.049
G1	23.70	24.00	24.30	0.933	0.945	0.957
H (2)	28.90	29.23	29.30	1.139	1.150	1.153
H1		17.00			0.669	
H2		12.80			0.503	
H3		0.80			0.031	
L (2)	21.64	22.04	22.44	0.852	0.868	0.883
L1	10.15	10.5	10.85	0.40	0.413	0.427
L2 (2)	15.50	15.70	15.90	0.610	0.618	0.626
L3	7.70	7.85	7.95	0.303	0.309	0.313
L4		5			0.197	
L5	5.15	5.45	5.85	0.203	0.214	0.23
L6	1.80	1.95	2.10	0.070	0.077	0.083
M	2.75	3.00	3.50	0.108	0.118	0.138
M1		4.73			0.186	
M2		5.61			0.220	
N		2.20			0.086	
P	3.20	3.50	3.80	0.126	0.138	0.15
R		1.70			0.067	
R1		0.50			0.02	
R2		0.30			0.12	
R3		1.25			0.049	
R4		0.50			0.02	
V	5 (typ.)					
V1	3 (typ.)					
V2	20 (typ.)					
V3	45 (typ.)					

OUTLINE AND MECHANICAL DATA



Flexiwatt25 (Horizontal)

(1): dam-bar protrusion not included; (2): molding protrusion included

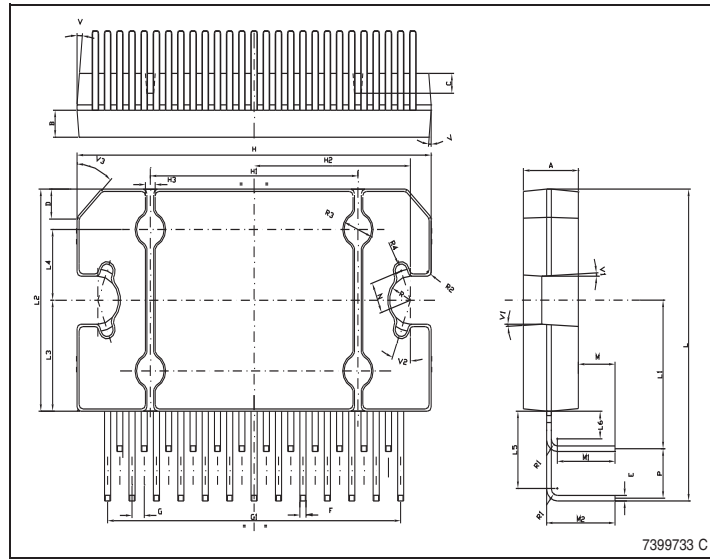

7399733 C

6 Revision history

Table 5. Document revision history

Date	Revision	Changes
22-Nov-2006	1	Initial release.
27-Feb-2007	2	Added Chapter 3.4: Electrical characteristic curves .
09-Oct-2007	3	Updated the values for the dV_{OS} and I_{q1} parameters on the Table 4 . Added Figure 20 on page 13 .
12-Sep-2008	4	Updated Figure 2: Standard test and application circuit . Updated Section 4.4: DC offset detector and Section 4.3: Standby and muting . Updated the values of V_{OS} and THD parameters on the Table 4 .
07-Nov-2008	5	Modified max. values of the THD distortion in Table 4: Electrical characteristics on page 8 .
17-Sep-2013	6	Updated Disclaimer.

Please Read Carefully:

Information in this document is provided solely in connection with ST products. STMicroelectronics NV and its subsidiaries ("ST") reserve the right to make changes, corrections, modifications or improvements, to this document, and the products and services described herein at any time, without notice.

All ST products are sold pursuant to ST's terms and conditions of sale.

Purchasers are solely responsible for the choice, selection and use of the ST products and services described herein, and ST assumes no liability whatsoever relating to the choice, selection or use of the ST products and services described herein.

No license, express or implied, by estoppel or otherwise, to any intellectual property rights is granted under this document. If any part of this document refers to any third party products or services it shall not be deemed a license grant by ST for the use of such third party products or services, or any intellectual property contained therein or considered as a warranty covering the use in any manner whatsoever of such third party products or services or any intellectual property contained therein.

UNLESS OTHERWISE SET FORTH IN ST'S TERMS AND CONDITIONS OF SALE ST DISCLAIMS ANY EXPRESS OR IMPLIED WARRANTY WITH RESPECT TO THE USE AND/OR SALE OF ST PRODUCTS INCLUDING WITHOUT LIMITATION IMPLIED WARRANTIES OF MERCHANTABILITY, FITNESS FOR A PARTICULAR PURPOSE (AND THEIR EQUIVALENTS UNDER THE LAWS OF ANY JURISDICTION), OR INFRINGEMENT OF ANY PATENT, COPYRIGHT OR OTHER INTELLECTUAL PROPERTY RIGHT.

ST PRODUCTS ARE NOT DESIGNED OR AUTHORIZED FOR USE IN: (A) SAFETY CRITICAL APPLICATIONS SUCH AS LIFE SUPPORTING, ACTIVE IMPLANTED DEVICES OR SYSTEMS WITH PRODUCT FUNCTIONAL SAFETY REQUIREMENTS; (B) AERONAUTIC APPLICATIONS; (C) AUTOMOTIVE APPLICATIONS OR ENVIRONMENTS, AND/OR (D) AEROSPACE APPLICATIONS OR ENVIRONMENTS. WHERE ST PRODUCTS ARE NOT DESIGNED FOR SUCH USE, THE PURCHASER SHALL USE PRODUCTS AT PURCHASER'S SOLE RISK, EVEN IF ST HAS BEEN INFORMED IN WRITING OF SUCH USAGE, UNLESS A PRODUCT IS EXPRESSLY DESIGNATED BY ST AS BEING INTENDED FOR "AUTOMOTIVE, AUTOMOTIVE SAFETY OR MEDICAL" INDUSTRY DOMAINS ACCORDING TO ST PRODUCT DESIGN SPECIFICATIONS. PRODUCTS FORMALLY ESCC, QML OR JAN QUALIFIED ARE DEEMED SUITABLE FOR USE IN AEROSPACE BY THE CORRESPONDING GOVERNMENTAL AGENCY.

Resale of ST products with provisions different from the statements and/or technical features set forth in this document shall immediately void any warranty granted by ST for the ST product or service described herein and shall not create or extend in any manner whatsoever, any liability of ST.

ST and the ST logo are trademarks or registered trademarks of ST in various countries.

Information in this document supersedes and replaces all information previously supplied.

The ST logo is a registered trademark of STMicroelectronics. All other names are the property of their respective owners.

© 2013 STMicroelectronics - All rights reserved

STMicroelectronics group of companies

Australia - Belgium - Brazil - Canada - China - Czech Republic - Finland - France - Germany - Hong Kong - India - Israel - Italy - Japan - Malaysia - Malta - Morocco - Philippines - Singapore - Spain - Sweden - Switzerland - United Kingdom - United States of America

www.st.com

Mouser Electronics

Authorized Distributor

Click to View Pricing, Inventory, Delivery & Lifecycle Information:

[STMicroelectronics:](#)

[TDA7850](#) [TDA7850H](#)