

Pin Assignments

(Top View)

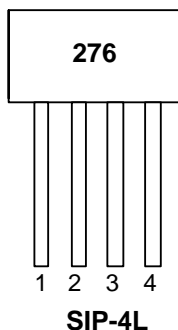

Pin Descriptions

Name	P/I/O	Pin #	Description
V _{CC}	P	1	Power Supply Input
DO	O	2	Output Pin
DOB	O	3	Output Pin
GND	P	4	Ground

Block Diagram

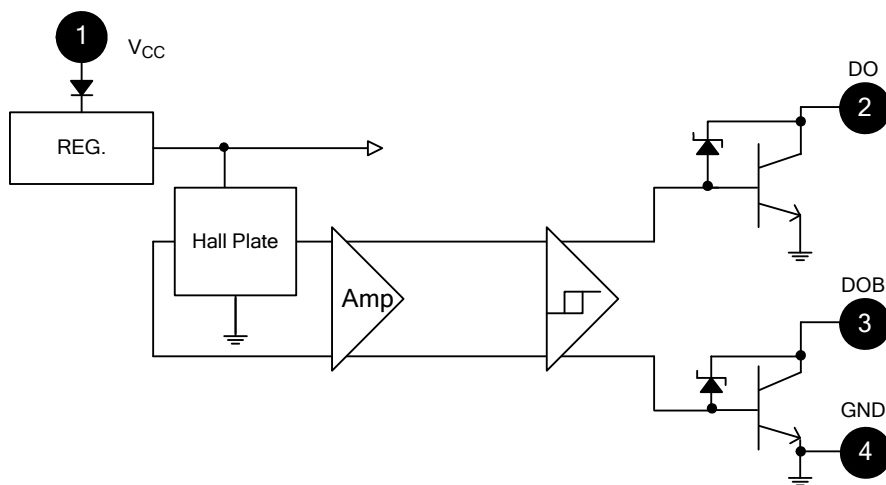

Typical Application Circuit

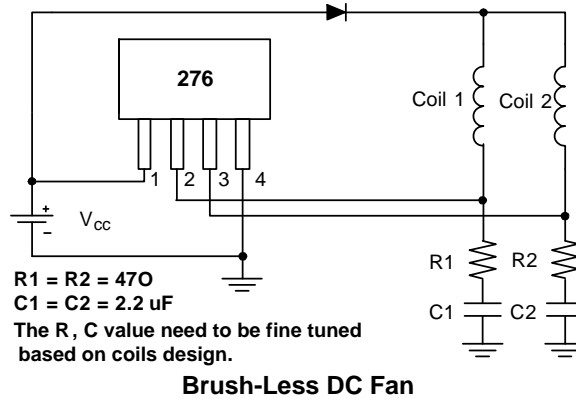

Absolute Maximum Ratings (T_A = 25°C)

Symbol	Characteristics	Values	Unit
V _{CC}	Supply Voltage	20	V
V _{RCC}	Reverse V _{CC} Polarity Voltage	-20	V
B	Magnetic Flux Density	Unlimited	
I _c	Output "on" Current	Continuous	0.4
		Hold	0.5
		Peak (Start Up)	0.7
T _S	Storage Temperature Range	-65~+150	°C
P _D	Package Power Dissipation	550	mW
T _J	Maximum Junction Temperature	150	°C

Recommended Operating Conditions

Symbol	Characteristic	Conditions	Min	Max	Unit
V _{CC}	Supply Voltage (Note 4)	Operating	3.5	20	V
T _A	Operating Ambient Temperature (Note 5)	Operating	-20	85	°C

Notes: 4. The output DO/DOB is switching as magnetic field change (S>300G, N<-300G).
5. Shall not exceed P_D and Safety Operation Area.

Electrical Characteristics (T_A = +25°C, V_{CC} = 4.0V to 20V)

Symbol	Characteristic	Conditions	Min	Typ.	Max	Units
V _{ce}	Low Supply Voltage	V _{CC} = 3.5V, I _L = 100mA		0.4		V
V _Z	Output Zener Breakdown	(Note 6)		46		V
V _{ce(SAT)}	Output Saturation Voltage	V _{CC} = 14V, I _L = 300mA		0.3	0.6	V
I _{ceX}	Output Leakage Current	V _{ce} = 14V, V _{CC} = 14V		<0.1	10	μA
I _{CC}	Supply Current	V _{CC} = 20V, Output Open		16	25	mA
t _r	Output Rise Time	V _{CC} = 14V, R _L = 820Ω, C _L = 20pF		3.0	10	μs
t _f	Output Falling Time	V _{CC} = 14V, R _L = 820Ω, C _L = 20pF		0.3	1.5	μs
Δt	Switch Time Differential	V _{CC} = 14V, R _L = 820Ω, C _L = 20pF		3.0	10	μs

Notes: 6. The V_Z may vary with the inductance/resistance of DC Fan. In order to reduce the risk of dynamic operation, the capacitor/ resistor is recommended to add below the DO/DOB as Application Circuit (see General Description on page 1).

Test Circuit

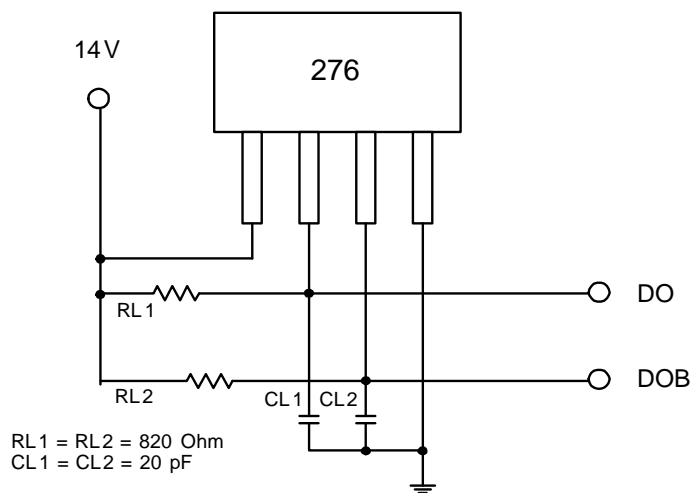

Magnetic Characteristics ($T_A = +25^\circ\text{C}$, $V_{CC} = 14\text{V}$)

(1mT = 10 Gauss)

A grade

Symbol	Characteristic	Min	Typ.	Max	Unit
Bop	Operation Point	10	-	50	Gauss
Brp	Release Point	-50	-	-10	Gauss
Bhy	Hysteresis	-	75	-	Gauss

B grade

Symbol	Characteristic	Min	Typ.	Max	Unit
Bop	Operation Point	5	-	70	Gauss
Brp	Release Point	-70	-	-5	Gauss
Bhy	Hysteresis	-	75	-	Gauss

C grade

Symbol	Characteristic	Min	Typ.	Max	Unit
Bop	Operation Point	-	-	100	Gauss
Brp	Release Point	-100	-	-	Gauss
Bhy	Hysteresis	-	75	-	Gauss

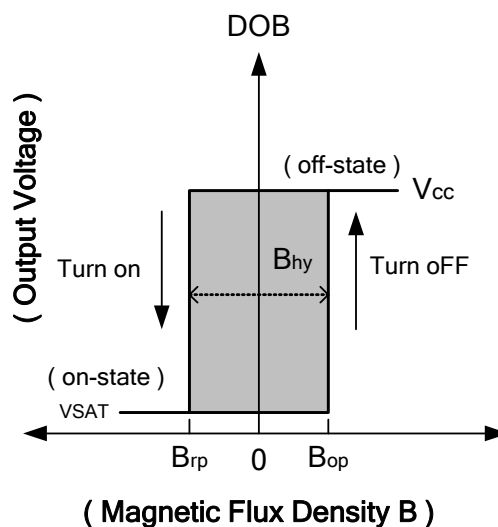
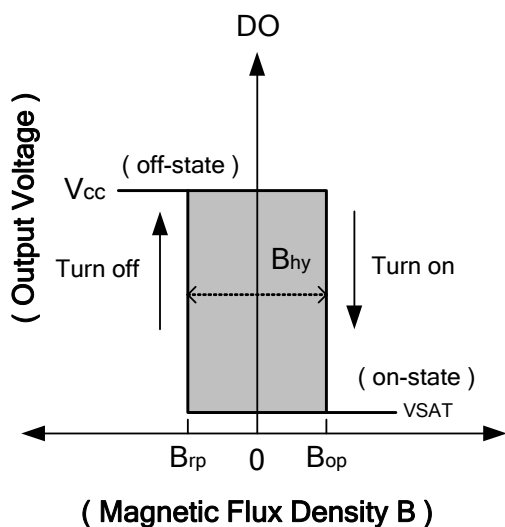

Operating Characteristics

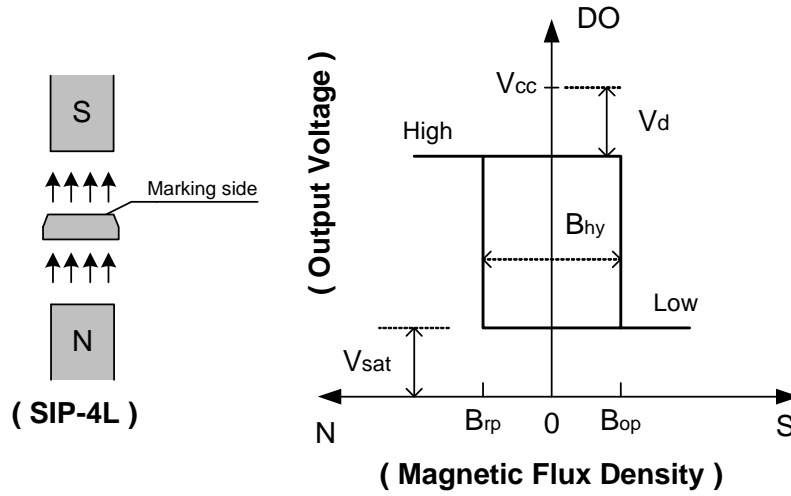

Performance Characteristics

T_A (°C)	25	50	60	70	80	85	90	95	100
P_D (mW)	550	440	396	352	308	286	264	242	220
T_A (°C)	105	110	115	120	125	130	135	140	150
P_D (mW)	198	176	154	132	110	88	66	44	0

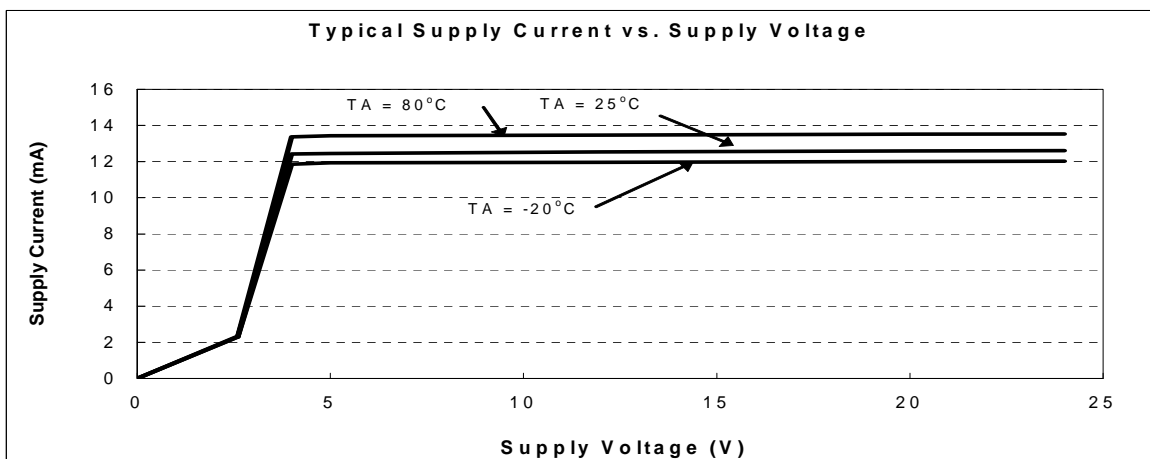
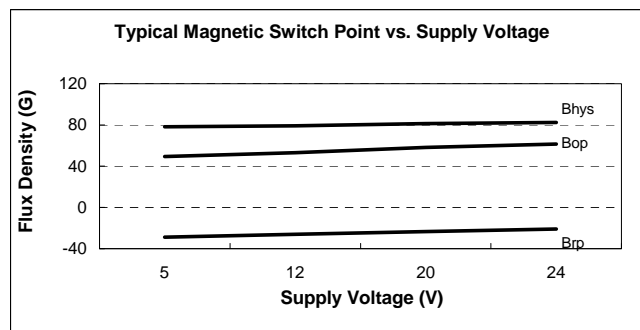
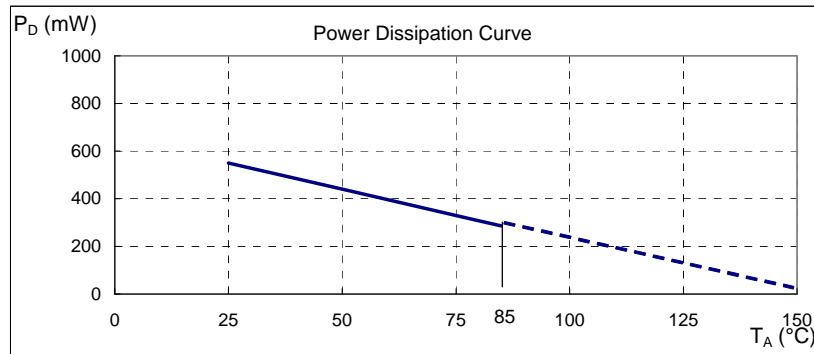

Marking Information

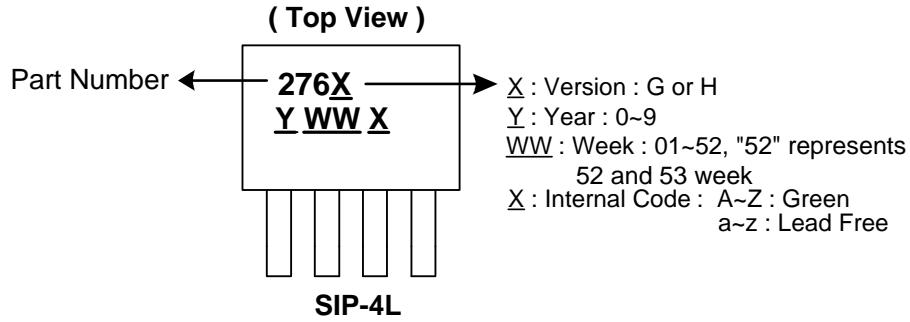

Package Information (All Dimensions in mm)

Active Area Depth

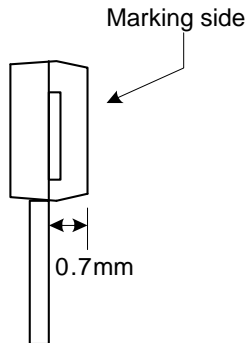

Package Sensor Location

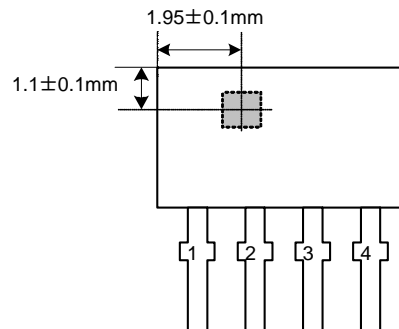

Package Dimension

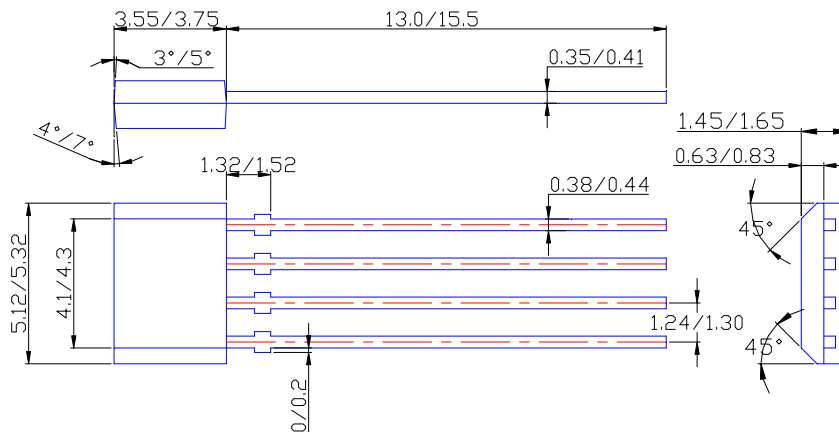

IMPORTANT NOTICE

Diodes Incorporated and its subsidiaries reserve the right to make modifications, enhancements, improvements, corrections or other changes without further notice to any product herein. Diodes Incorporated does not assume any liability arising out of the application or use of any product described herein; neither does it convey any license under its patent rights, nor the rights of others. The user of products in such applications shall assume all risks of such use and will agree to hold Diodes Incorporated and all the companies whose products are represented on our website, harmless against all damages.

LIFE SUPPORT

Diodes Incorporated products are not authorized for use as critical components in life support devices or systems without the expressed written approval of the President of Diodes Incorporated.

Mouser Electronics

Authorized Distributor

Click to View Pricing, Inventory, Delivery & Lifecycle Information:

[Diodes Incorporated:](#)

[ATS276H-PG-B-A](#) [ATS276H-PG-B-B](#) [ATS276](#)