

## ABSOLUTE MAXIMUM RATINGS

(Notes 1, 2)

Pins with Respect to  $V_{PORTN}$

$V_{PORTP}$ Voltage .....	-0.3V to 100V
$V_{NEG}$ Voltage .....	-0.3V to $V_{PORTP}$
$V_{NEG}$ Pull-Up Current .....	1A
SHDN .....	-0.3V to 100V
$R_{CLASS}$ , Voltage .....	-0.3V to 7V
$R_{CLASS}$ Source Current .....	50mA
PWRGD Voltage (Note 3) Low Impedance Source .... $V_{NEG} - 0.3V$ to $V_{NEG} + 11V$ Sink Current .....	5mA
PWRGD, $\overline{T2P}$ Voltage .....	-0.3V to 100V
PWRGD, $\overline{T2P}$ Sink Current .....	10mA

Pins with Respect to GND

$V_{IN}$ (Note 4) .....	-0.3V to 25V
SYNC, SS_MAXDC, SD_VSEC, $I_{SENSE}$ , OC .....	-0.3V to 6V
COMP, BLANK, DELAY .....	-0.3V to 3.5V
FB .....	-0.3V to 3V
$R_{OSC}$ Current .....	-50 $\mu$ A
$V_{REF}$ Source Current .....	10mA

Operating Ambient Temperature Range

LTC4269C-2 .....	0°C to 70°C
LTC4269I-2 .....	-40°C to 85°C

## PIN CONFIGURATION

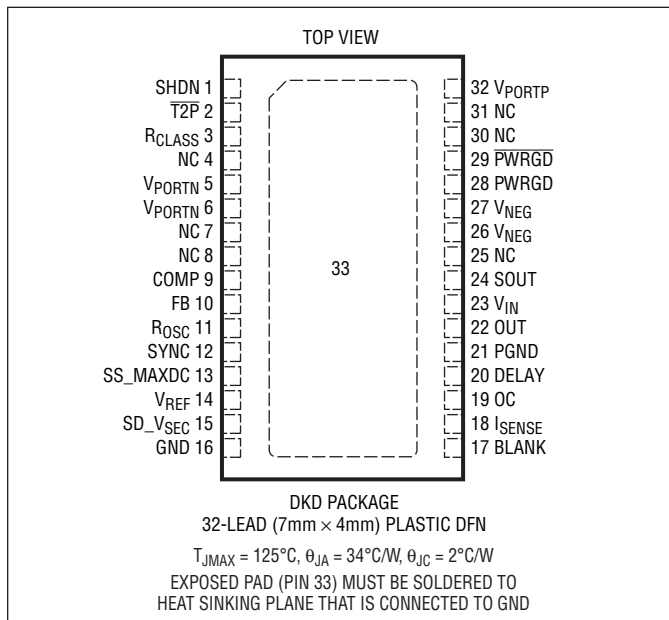

## ORDER INFORMATION

LEAD FREE FINISH	TAPE AND REEL	PART MARKING*	PACKAGE DESCRIPTION	TEMPERATURE RANGE
LTC4269CDKD-2#PBF	LTC4269CDKD-2#TRPBF	42692	32-Lead (7mm x 4mm) Plastic DFN	0°C to 70°C
LTC4269IDKD-2#PBF	LTC4269IDKD-2#TRPBF	42692	32-Lead (7mm x 4mm) Plastic DFN	-40°C to 85°C
LEAD BASED FINISH	TAPE AND REEL	PART MARKING*	PACKAGE DESCRIPTION	TEMPERATURE RANGE
LTC4269CDKD-2	LTC4269CDKD-2#TR	42692	32-Lead (7mm x 4mm) Plastic DFN	0°C to 70°C
LTC4269IDKD-2	LTC4269IDKD-2#TR	42692	32-Lead (7mm x 4mm) Plastic DFN	-40°C to 85°C

Consult LTC Marketing for parts specified with wider operating temperature ranges. \*The temperature grade is identified by a label on the shipping container.

For more information on lead free part marking, go to: <http://www.linear.com/leadfree/>

For more information on tape and reel specifications, go to: <http://www.linear.com/tapeandreeel/>

## ELECTRICAL CHARACTERISTICS

The ● denotes the specifications which apply over the full operating temperature range, otherwise specifications are at  $T_A = 25^\circ\text{C}$ .

PARAMETER	CONDITIONS	MIN	TYP	MAX	UNITS	
<b>Interface Controller (Note 5)</b>						
Operating Input Voltage	At $V_{PORTP}$ (Note 6)			60	V	
Signature Range		● 1.5		9.8	V	
Classification Range		● 12.5		21.0	V	
On Voltage		● 30.0		37.2	V	
Undervoltage Lockout			71.0		V	
Overvoltage Lockout					V	
ON/UVLO Hysteresis Window		● 4.1			V	
Signature/Class Hysteresis Window		● 1.4			V	
Reset Threshold	State Machine Reset for 2-Event Classification	● 2.57		5.40	V	
<b>Supply Current</b>						
Supply Current at 57V	Measured at $V_{PORTP}$ Pin	●		1.35	mA	
Class 0 Current	$V_{PORTP} = 17.5\text{V}$ , No $R_{CLASS}$ Resistor	●		0.40	mA	
<b>Signature</b>						
Signature Resistance	$1.5\text{V} \leq V_{PORTP} \leq 9.8\text{V}$ (Note 7)	●	23.25	26.00	k $\Omega$	
Invalid Signature Resistance, SHDN Invoked	$1.5\text{V} \leq V_{PORTP} \leq 9.8\text{V}$ , $V_{SHDN} = 3\text{V}$ (Note 7)	●		11	k $\Omega$	
Invalid Signature Resistance During Mark Event	(Notes 7, 8)	●		11	k $\Omega$	
<b>Classification</b>						
Class Accuracy	$10\text{mA} < I_{CLASS} < 40\text{mA}$ , $12.5\text{V} < V_{PORTP} < 21\text{V}$ (Notes 9, 10)	●		$\pm 3.5$	%	
Classification Stability Time	$V_{PORTP}$ Pin Step to 17.5V, $R_{CLASS} = 30.9\Omega$ , $I_{CLASS}$ within 3.5% of Ideal Value (Notes 9, 10)	●		1	ms	
<b>Normal Operation</b>						
Inrush Current	$V_{PORTP} = 54\text{V}$ , $V_{NEG} = 3\text{V}$	●	60	100	180	mA
Power FET On-Resistance	Tested at 600mA into $V_{NEG}$ , $V_{PORTP} = 54\text{V}$	●		0.7	1.0	$\Omega$
Power FET Leakage Current at $V_{NEG}$	$V_{PORTP} = \text{SHDN} = V_{NEG} = 57\text{V}$	●		1		$\mu\text{A}$
<b>Digital Interface</b>						
SHDN Input High Level Voltage		●	3		V	
SHDN Input Low Level Voltage		●		0.45	V	
SHDN Input Resistance	$V_{PORTP} = 9.8\text{V}$ , $\text{SHDN} = 9.65\text{V}$	●	100		k $\Omega$	
PWRGD, $\overline{\text{T2P}}$ Output Low Voltage	Tested at 1mA, $V_{PORTP} = 57\text{V}$ , For $\overline{\text{T2P}}$ , Must Complete 2-Event Classification to See Active Low	●		0.15	V	
PWRGD, $\overline{\text{T2P}}$ Leakage Current	Pin Voltage Pulled 57V, $V_{PORTP} = V_{PORTN} = 0\text{V}$	●		1	$\mu\text{A}$	
PWRGDP Output Low Voltage	Tested at 0.5mA, $V_{PORTP} = 52\text{V}$ , $V_{NEG} = 4\text{V}$ , Output Voltage is with Respect to $V_{NEG}$	●		0.4	V	
PWRGDP Clamp Voltage	Tested at 2mA, $V_{NEG} = 0\text{V}$ , Voltage is with Respect to $V_{NEG}$	●	12.0	16.5	V	
PWRGDP Leakage Current	$V_{PWRGD} = 11\text{V}$ , $V_{NEG} = 0\text{V}$ , Voltage is with Respect to $V_{NEG}$	●		1	$\mu\text{A}$	
<b>PWM Controller (Note 11)</b>						
Operational Input Voltage	$I_{VREF} = 0\mu\text{A}$	●	$V_{IN(OFF)}$	25	V	
$V_{IN}$ Quiescent Current	$I_{VREF} = 0\mu\text{A}$ , $I_{SENSE} = \text{OC} = \text{Open}$			5.2	6.5	mA
$V_{IN}$ Start-Up Current	$\text{FB} = 0\text{V}$ , $\text{SS\_MAXDC} = 0\text{V}$ (Notes 12, 13)	●		460	700	$\mu\text{A}$
$V_{IN}$ Shutdown Current	$\text{SD\_VSEC} = 0\text{V}$ (Notes 12, 13)	●		240	350	$\mu\text{A}$
$\text{SD\_VSEC}$ Threshold	$10\text{V} < \text{SD} < 25\text{V}$		1.261	1.32	1.379	V

## ELECTRICAL CHARACTERISTICS

The ● denotes the specifications which apply over the full operating temperature range, otherwise specifications are at  $T_A = 25^\circ\text{C}$ .

PARAMETER	CONDITIONS		MIN	TYP	MAX	UNITS
$SD\_V_{SEC(ON)}$ Current	$SD\_V_{SEC} = SD\_V_{SEC}$ Threshold +100mV			0		$\mu\text{A}$
$SD\_V_{SEC(OFF)}$ Current	$SD\_V_{SEC} = SD\_V_{SEC}$ Threshold – 100mV		8.3	10	11.7	$\mu\text{A}$
$V_{IN(ON)}$		●		14.25	15.75	V
$V_{IN(OFF)}$		●		8.75	9.25	V
$V_{IN(HYST)}$		●	3.75	5.5	7.0	V
<b>V<sub>REF</sub></b>						
Output Voltage	$I_{VREF} = 0$	●	2.425	2.5	2.575	V
Line Regulation	$I_{VREF} = 0, 10V < V_{IN} < 25V$			1	10	mV
Load Regulation	$0\text{mA} < I_{VREF} < 2.5\text{mA}$			1	10	mV
<b>Oscillator</b>						
Frequency, $f_{OSC}$	$R_{OSC} = 178\text{k}, \text{FB} = 1V, \text{SS\_MAXDC} = 1.84V$	●	165	200	240	kHz
$f_{OSC(MIN)}$	$R_{OSC} = 365\text{k}, \text{FB} = 1V$		80	100	120	kHz
$f_{OSC(MAX)}$	$R_{OSC} = 64.9\text{k}, \text{COMP} = 2.5V, SD\_V_{SEC} = 2.64V$		440	500	560	kHz
SYNC Input Resistance				18		k $\Omega$
SYNC Switching Threshold	$\text{FB} = 1V$			1.5	2.2	V
SYNC Frequency/ $f_{OSC}$	$\text{FB} = 1V$ (Note 14)			1.25	1.5	
$f_{OSC}$ Line Regulation	$R_{OSC} = 178\text{k}; 10V < V_{IN} < 25V, \text{SS\_MAXDC} = 1.84V$			0.05	0.33	%/V
$V_{ROSC}$	$R_{OSC}$ Pin Voltage			1		V
<b>Error Amplifier</b>						
FB Reference Voltage	$10V < V_{IN} < 25V, V_{OL} + 0.2V < \text{COMP} < V_{OH} - 0.2$	●	1.201	1.226	1.250	V
FB Input Bias Current	$\text{FB} = \text{FB Reference Voltage}$			-75	-200	nA
Open-Loop Voltage Gain	$V_{OL} + 0.2V < \text{COMP} < V_{OH} - 0.2$		65	85		dB
Unity-Gain Bandwidth	(Note 15)			3		MHz
COMP Source Current	$\text{FB} = 1V, \text{COMP} = 1.6V$		-4	-9		mA
COMP Sink Current	$\text{COMP} = 1.6V$		4	10		mA
COMP Current (Disabled)	$\text{FB} = V_{REF}, \text{COMP} = 1.6V$		18	23	28	$\mu\text{A}$
COMP High Level $V_{OH}$	$\text{FB} = 1V, I_{COMP} = -250\mu\text{A}$		2.7	3.2		V
COMP Active Threshold	$\text{FB} = 1V, \text{SOUT Duty Cycle} > 0\%$		0.7	0.8		V
COMP Low Level $V_{OL}$	$I_{COMP} = 250\mu\text{A}$			0.15	0.4	V
<b>Current Sense</b>						
$I_{SENSE}$ Maximum Threshold	$\text{COMP} = 2.5V, \text{FB} = 1V$		197	220	243	mV
$I_{SENSE}$ Input Current (Duty Cycle = 0%)	$\text{COMP} = 2.5V, \text{FB} = 1V$ (Note 12)			-8		$\mu\text{A}$
$I_{SENSE}$ Input Current (Duty Cycle = 80%)	$\text{COMP} = 2.5V, \text{FB} = 1V$ (Note 12)			-35		$\mu\text{A}$
OC Threshold	$\text{COMP} = 2.5V, \text{FB} = 1V$		98	107	116	mV
OC Input Current	(OC = 100mV)			-50	-100	nA
Default Blanking Time	$\text{COMP} = 2.5V, \text{FB} = 1V, R_{BLANK} = 40\text{k}$ (Note 16)			180		ns
Adjustable Blanking Time	$\text{COMP} = 2.5V, \text{FB} = 1V, R_{BLANK} = 120\text{k}$			540		ns
$V_{BLANK}$				1		V
<b>SOUT Driver</b>						
SOUT Clamp Voltage	$I_{GATE} = 0\mu\text{A}, \text{COMP} = 2.5V, \text{FB} = 1V$		10.54	12	13.5	V
SOUT Low Level	$I_{GATE} = 25\text{mA}$			0.5	0.75	V

## ELECTRICAL CHARACTERISTICS

The ● denotes the specifications which apply over the full operating temperature range, otherwise specifications are at  $T_A = 25^\circ\text{C}$ .

PARAMETER	CONDITIONS	MIN	TYP	MAX	UNITS
SOUT High Level	$I_{\text{GATE}} = -25\text{mA}$ , $V_{\text{IN}} = 12\text{V}$ COMP = 2.5V, FB = 1V	10			V
SOUT Active Pull-Off in Shutdown	$V_{\text{IN}} = 5\text{V}$ , $\text{SD\_VSEC} = 0\text{V}$ , SOUT = 1V	1			mA
SOUT to OUT (Rise) DELAY ( $t_{\text{DELAY}}$ )	COMP = 2.5V, FB = 1V (Note 16) $R_{\text{DELAY}} = 120\text{k}$		40 120		ns ns
$V_{\text{DELAY}}$			0.9		V
<b>OUT Driver</b>					
OUT Rise Time	FB = 1V, $C_L = 1\text{nF}$ (Notes 15, 16)		50		ns
OUT Fall Time	FB = 1V, $C_L = 1\text{nF}$ (Notes 15, 16)		30		ns
OUT Clamp Voltage	$I_{\text{GATE}} = 0\mu\text{A}$ , COMP = 2.5V, FB = 1V	11.5	13	14.5	V
OUT Low Level	$I_{\text{GATE}} = 20\text{mA}$ $I_{\text{GATE}} = 200\text{mA}$		0.45 1.25	0.75 1.8	V V
OUT High Level	$I_{\text{GATE}} = -20\text{mA}$ , $V_{\text{IN}} = 12\text{V}$ COMP = 2.5V, FB = 1V $I_{\text{GATE}} = -200\text{mA}$ , $V_{\text{IN}} = 12\text{V}$ COMP = 2.5V, FB = 1V	9.9 9.75			V V
OUT Active Pull-Off in Shutdown	$V_{\text{IN}} = 5\text{V}$ , $\text{SD\_VSEC} = 0\text{V}$ , OUT = 1V	20			mA
OUT Max Duty Cycle	COMP = 2.5V, FB = 1V, $R_{\text{DELAY}} = 10\text{k}$ ( $f_{\text{OSC}} = 200\text{kHz}$ ), $V_{\text{IN}} = 10\text{V}$ , $\text{SD\_VSEC} = 1.4\text{V}$ , $\text{SS\_MAXDC} = V_{\text{REF}}$	83	90		%
OUT Max Duty Cycle Clamp	COMP = 2.5V, FB = 1V, $R_{\text{DELAY}} = 10\text{k}$ ( $f_{\text{OSC}} = 200\text{kHz}$ ), $V_{\text{IN}} = 10\text{V}$ $\text{SD\_VSEC} = 1.32\text{V}$ , $\text{SS\_MAXDC} = 1.84\text{V}$ $\text{SD\_VSEC} = 2.64\text{V}$ , $\text{SS\_MAXDC} = 1.84\text{V}$	63.5 25	72 33	80.5 41	% %
<b>Soft-Start</b>					
SS_MAXDC Low Level: $V_{\text{OL}}$	$I_{\text{SS\_MAXDC}} = 150\mu\text{A}$ , OC = 1V		0.2		V
SS_MAXDC Soft-Start Reset Threshold	Measured on SS_MAXDC		0.45		V
SS_MAXDC Active Threshold	FB + 1V, DC > 0%		0.8		V
SS_MAXDC Input Current (Soft-Start Pull-Down: $I_{\text{DIS}}$ )	SS_MAXDC = 1V, $\text{SD\_VSEC} = 1.4\text{V}$ , OC = 1V		800		$\mu\text{A}$

**Note 1:** Stresses beyond those listed under Absolute Maximum Ratings may cause permanent damage to the device. Exposure to any Absolute Maximum Rating condition for extended periods may affect device reliability and lifetime.

**Note 2:** Pins with 100V absolute maximum guaranteed for  $T \geq 0^\circ\text{C}$ , otherwise 90V.

**Note 3:** PWRGD voltage clamps at 14V with respect to  $V_{\text{NEG}}$ .

**Note 4:** In applications where the  $V_{\text{IN}}$  pin is supplied via an external RC network from a system  $V_{\text{IN}} > 25\text{V}$ , an external Zener with clamp voltage  $V_{\text{IN ON(MAX)}} < V_Z < 25\text{V}$  should be connected from the  $V_{\text{IN}}$  pin to GND.

**Note 5:** All voltages are with respect to  $V_{\text{PORTN}}$  pin unless otherwise noted.

**Note 6:** Input voltage specifications are defined with respect to LTC4269-2 pins and meet IEEE 802.3af/at specifications when the input diode bridge is included.

**Note 7:** Signature resistance is measured via the  $\Delta V/\Delta I$  method with the minimum  $\Delta V$  of 1V. The LTC4269-2 signature resistance accounts for the additional series resistance in the input diode bridge.

**Note 8:** An invalid signature after the 1st classification event is mandated by IEEE 802.3at standard. See the Applications Information section.

**Note 9:** Class accuracy is respect to the ideal current defined as  $1.237/R_{\text{CLASS}}$  and does not include variations in  $R_{\text{CLASS}}$  resistance.

**Note 10:** This parameter is assured by design and wafer level testing.

**Note 11:** Voltages are with respect to GND unless otherwise specified. Tested with COMP open,  $V_{\text{FB}} = 1.4\text{V}$ ,  $R_{\text{ROSC}} = 178\text{k}$ ,  $V_{\text{SYNC}} = 0\text{V}$ ,  $V_{\text{SS(MAXDC)}} = V_{\text{REF}}$  (but electrically isolated),  $C_{\text{VREF}} = 0.1\mu\text{F}$ ,  $V_{\text{SD\_VSEC}} = 2\text{V}$ ,  $R_{\text{BLANK}} = 121\text{k}$ ,  $R_{\text{DELAY}} = 121\text{k}$ ,  $V_{\text{ISENSE}} = 0\text{V}$ ,  $V_{\text{OC}} = 0\text{V}$ ,  $C_{\text{OUT}} = 1\text{nF}$ ,  $V_{\text{IN}} = 15\text{V}$ , SOUT open, unless otherwise specified.

**Note 12:** Guaranteed by correlation to static test.

**Note 13:**  $V_{\text{IN}}$  start-up current is measured at  $V_{\text{IN}} = V_{\text{IN(ON)}} - 0.25\text{V}$  and scaled by  $\times 1.18$  (to correlate to worst-case  $V_{\text{IN}}$  start-up current at  $V_{\text{IN(ON)}}$ ).

**Note 14:** Maximum recommended SYNC frequency = 500kHz.

**Note 15:** Guaranteed but not tested.

**Note 16:** Timing for R = 40k derived from measurement with R = 240k.

## TYPICAL PERFORMANCE CHARACTERISTICS

**Input Current vs Input Voltage  
25k Detection Range**

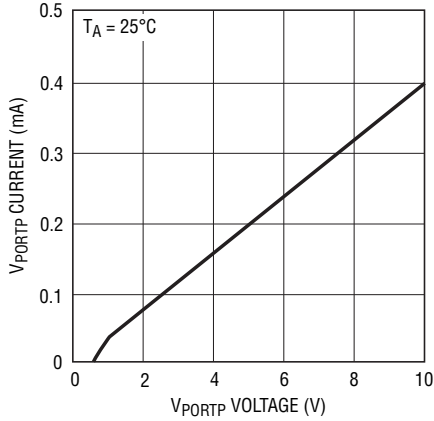

42692 G01

**Input Current vs Input Voltage**

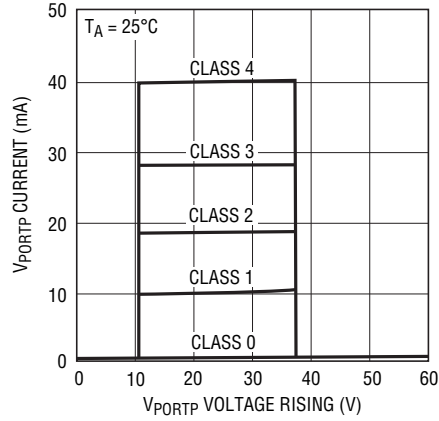

42692 G02

**Input Current vs Input Voltage**

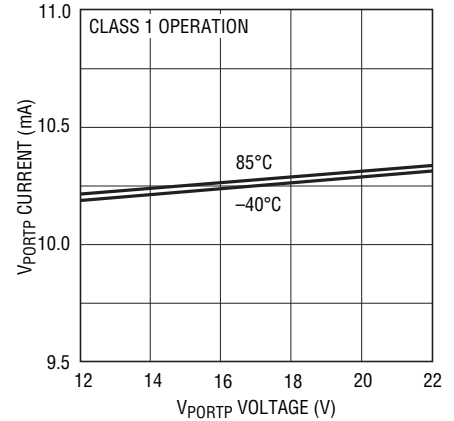

42692 G03

**Signature Resistance vs Input Voltage**

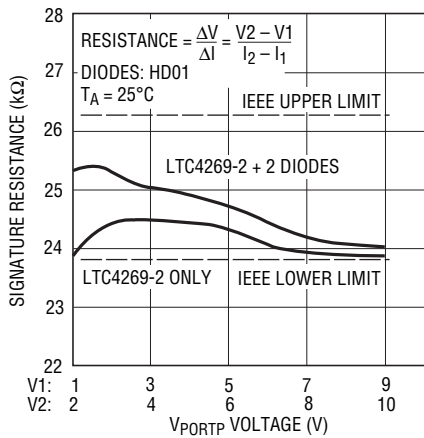

42692 G04

**Class Operation vs Time**

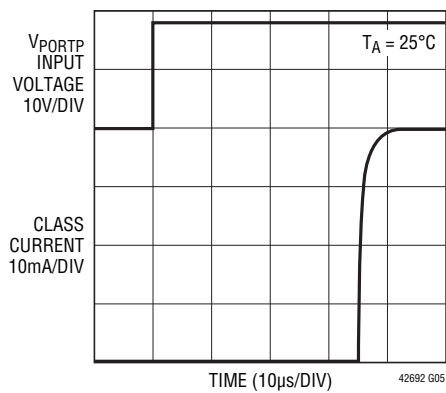

42692 G05

**On-Resistance vs Temperature**

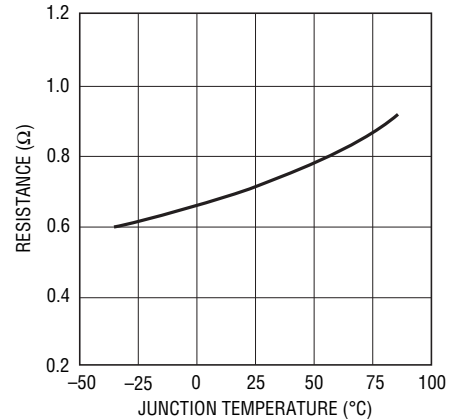

42692 G06

**PWRGD, T2P Output Low Voltage vs Current**

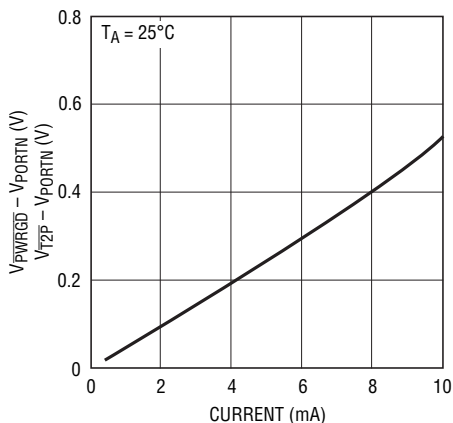

42692 G07

**Active High PWRGD Output Low Voltage vs Current**

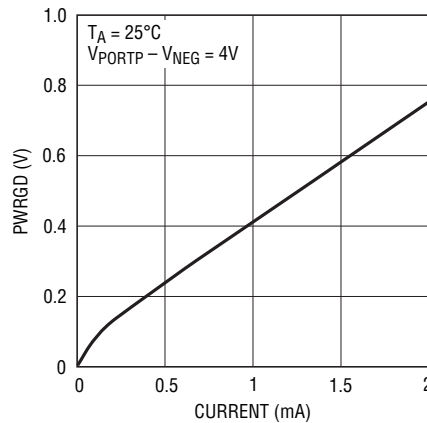

42692 G08

**FB Voltage vs Temperature**

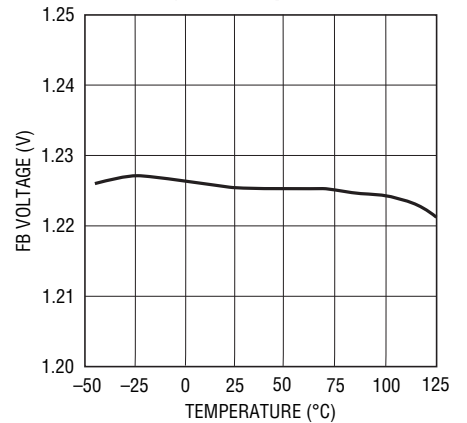

42692 G09

# TYPICAL PERFORMANCE CHARACTERISTICS

**Switching Frequency vs Temperature**

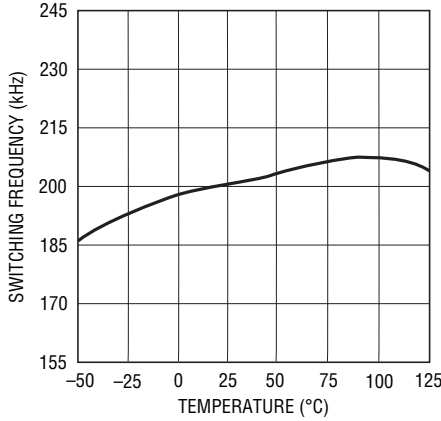

42692 G10

**V<sub>IN</sub> Shutdown Current vs Temperature**

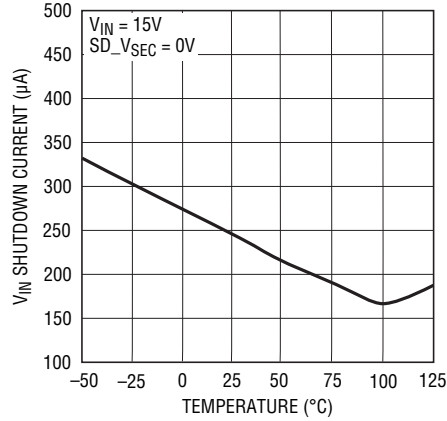

42692 G11

**V<sub>IN</sub> Start-Up Current vs Temperature**

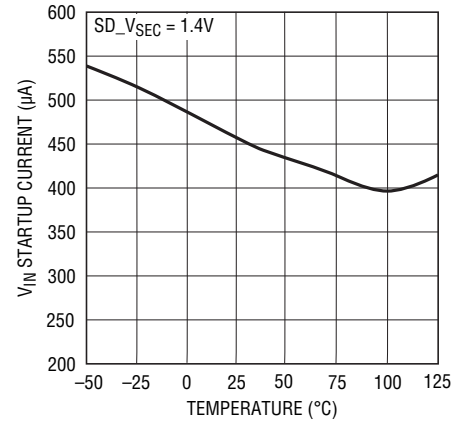

42692 G12

**I<sub>Q</sub> (V<sub>IN</sub>) vs Temperature**

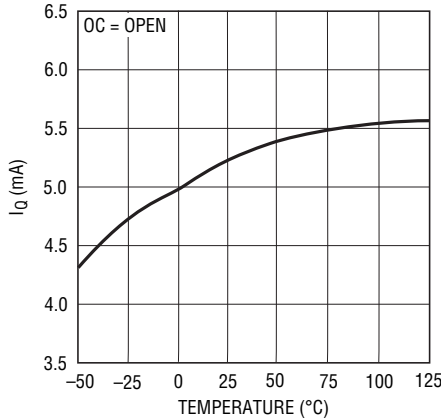

42692 G13

**SD\_VSEC Turn On Threshold vs Temperature**

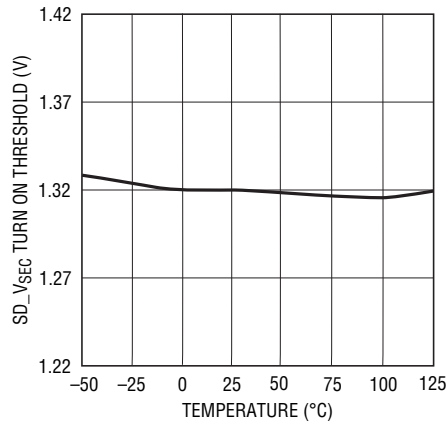

42692 G14

**SD\_VSEC Pin Current vs Temperature**

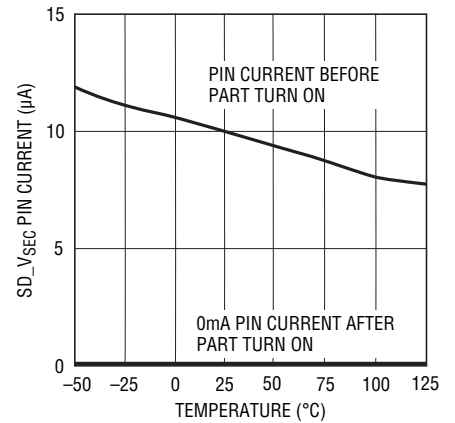

42692 G15

**V<sub>IN</sub> Turn On/Off Voltage vs Temperature**

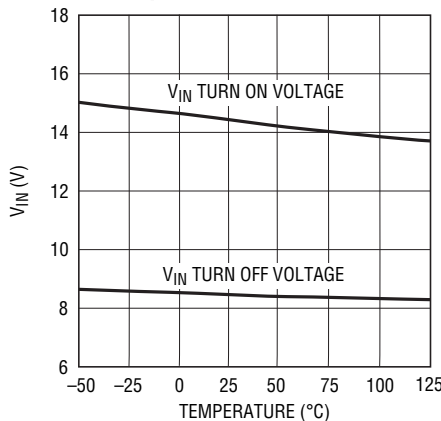

42692 G16

**COMP Active Threshold vs Temperature**

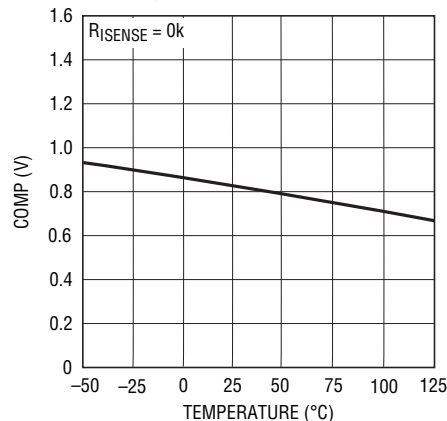

42692 G17

**COMP Source Current vs Temperature**

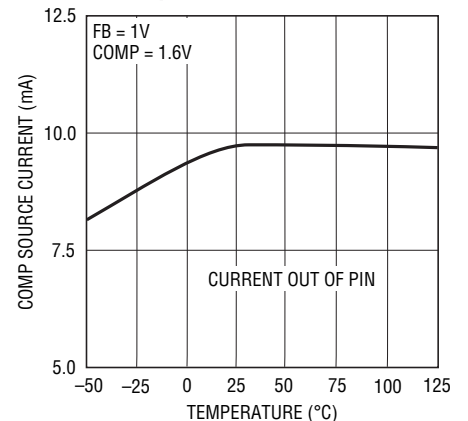

42692 G18

## TYPICAL PERFORMANCE CHARACTERISTICS

**COMP Sink Current vs Temperature**

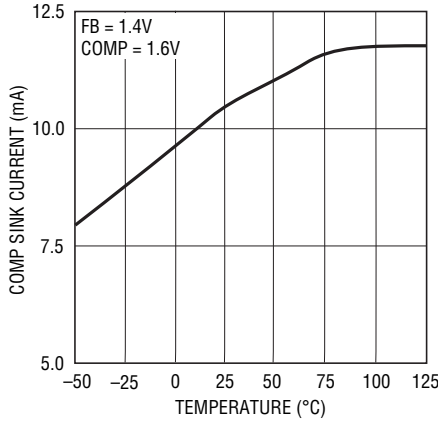

42692 G19

**(Disabled) COMP Pin Current vs Temperature**

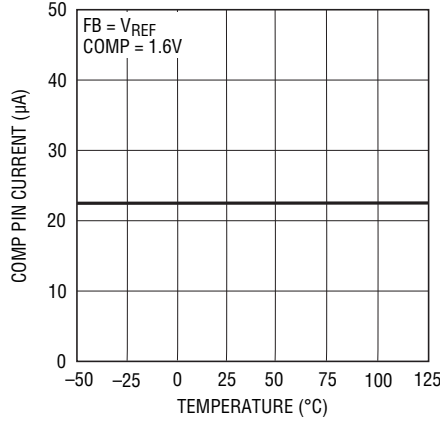

42692 G20

**I<sub>SENSE</sub> Maximum Threshold vs COMP**

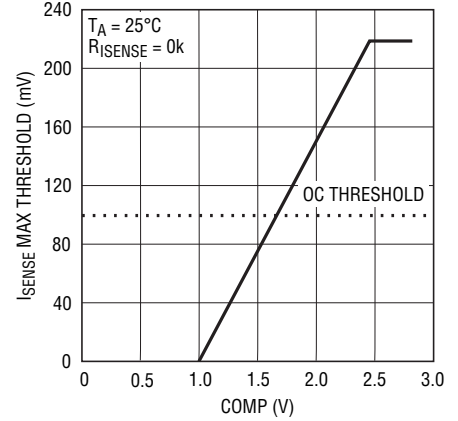

42692 G21

**I<sub>SENSE</sub> Maximum Threshold vs Temperature**

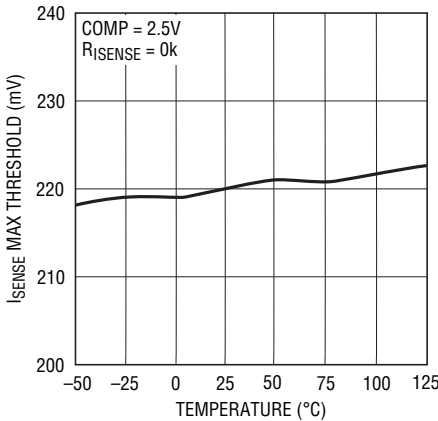

42692 G22

**I<sub>SENSE</sub> Pin Current (Out of Pin) vs Duty Cycle**

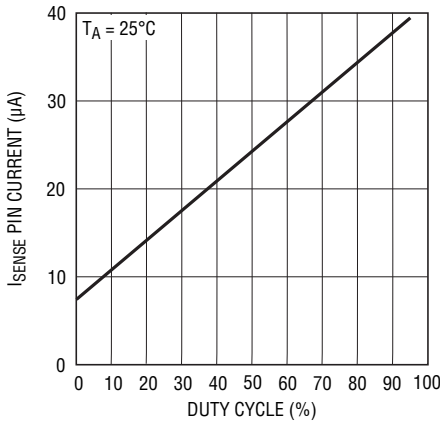

42692 G23

**I<sub>SENSE</sub> Maximum Threshold vs Duty Cycle (Programming Slope Compensation)**

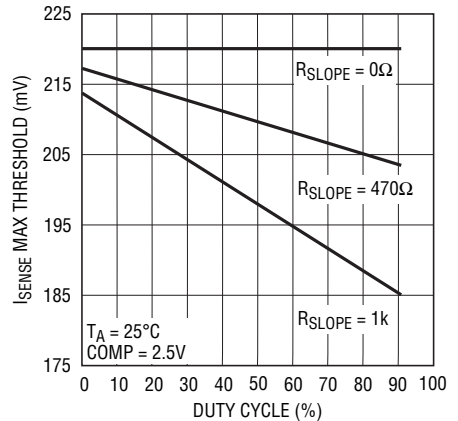

42692 G24

**OC (Overcurrent) Threshold vs Temperature**

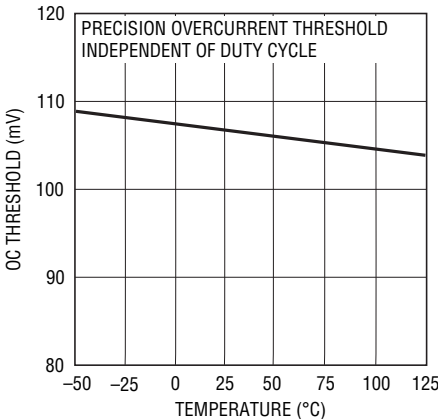

42692 G25

**Blank Duration vs Temperature**

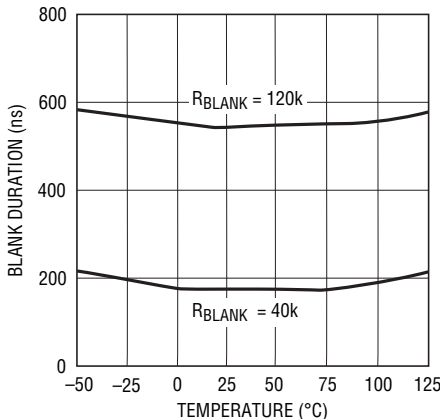

42692 G26

**BLANK Duration vs R<sub>BLANK</sub>**

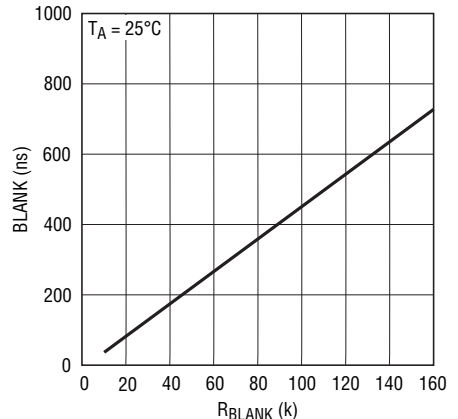

42692 G27

# TYPICAL PERFORMANCE CHARACTERISTICS

**$t_{DELAY}$ : SOUT Rise to OUT Rise vs Temperature**

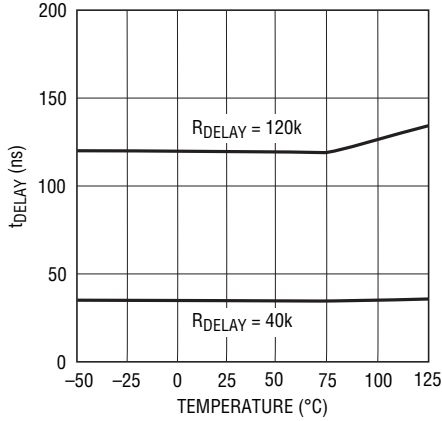

42692 G28

**$t_{DELAY}$ : SOUT Rise to OUT Rise vs  $R_{DELAY}$**

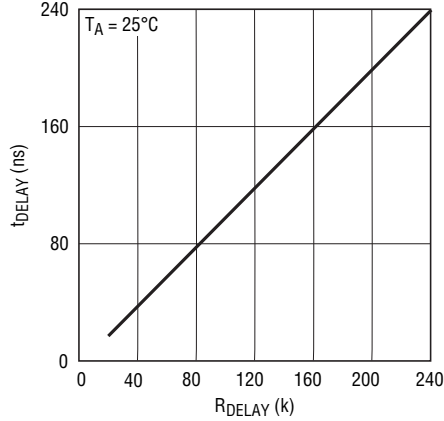

42692 G29

**OUT Rise/Fall Time vs OUT Load Capacitance**

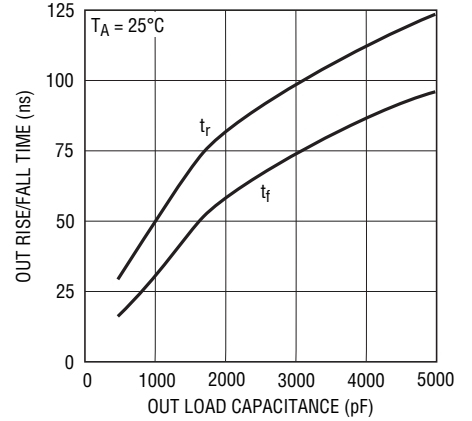

42692 G30

**OUT: Max Duty Cycle vs  $f_{OSC}$**

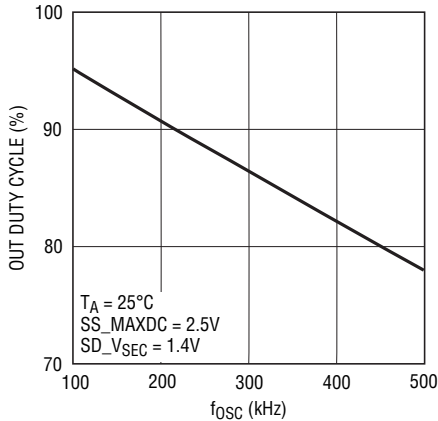

42692 G31

**OUT: Max Duty Cycle CLAMP vs  $SD\_VSEC$**

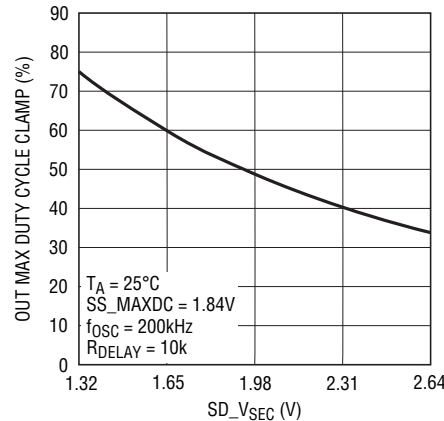

42692 G32

**OUT: Max Duty Cycle CLAMP vs  $SS\_MAXDC$**

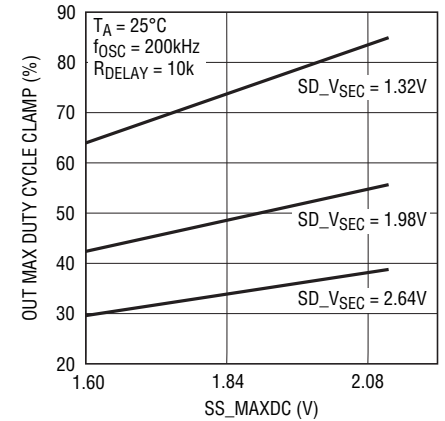

42692 G33

**$SS\_MAXDC$  Setting vs  $f_{OSC}$  (for OUT DC = 72%)**

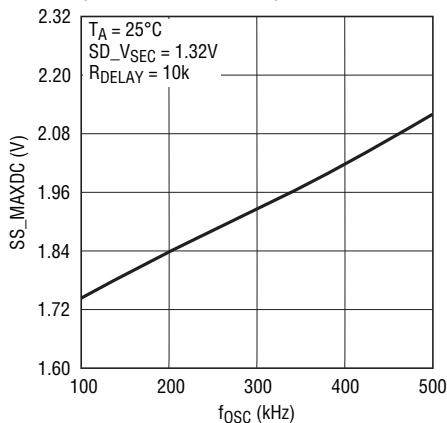

42692 G34

**$SS\_MAXDC$  Reset and Active Thresholds vs Temperature**

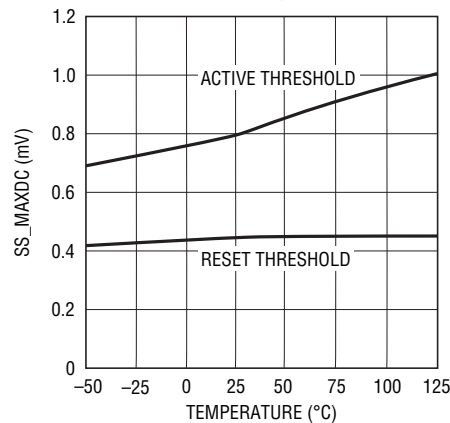

42692 G35



## PIN FUNCTIONS

**SHDN (Pin 1):** Shutdown Input. Use this pin for auxiliary power application. Drive SHDN high to disable LTC4269-2 operation and corrupt the signature resistance. If unused, tie SHDN to  $V_{PORTN}$ .

**$\overline{T2P}$  (Pin 2):** Type-2 PSE Indicator, Open-Drain. Low impedance indicates the presence of a Type-2 PSE.

**$R_{CLASS}$  (Pin 3):** Class Select Input. Connect a resistor between  $R_{CLASS}$  and  $V_{PORTN}$  to set the classification load current.

**$V_{PORTN}$  (Pins 5, 6):** Power Input. Tie to the PD input through the diode bridge. Pins 5 and 6 must be electrically tied together at the package.

**NC (Pins 4, 7, 8, 25, 30, 31):** No Connect.

**COMP (Pin 9):** Output Pin of the Error Amplifier. The error amplifier is an op amp, allowing various compensation networks to be connected between the COMP pin and FB pin for optimum transient response in a nonisolated supply. The voltage on this pin corresponds to the peak current of the external FET. Full operating voltage range is between 0.8V and 2.5V corresponding to 0mV to 220mV at the  $I_{SENSE}$  pin. For applications using the 100mV OC pin for overcurrent detection, typical operating range for the COMP pin is 0.8V to 1.6V. For isolated applications where COMP is controlled by an opto-coupler, the COMP pin output drive can be disabled with  $FB = V_{REF}$ , reducing the COMP pin current to  $(COMP - 0.7)/40k$ .

**FB (Pin 10):** In a nonisolated supply, FB monitors the output voltage via an external resistor divider and is compared with an internal 1.23V reference by the error amplifier. FB connected to  $V_{REF}$  disables error amplifier output.

**$R_{OSC}$  (Pin 11):** A resistor to GND programs the operating frequency of the IC between 100kHz and 500kHz. Nominal voltage on the  $R_{OSC}$  pin is 1.0V.

**SYNC (Pin 12):** Used to synchronize the internal oscillator to an external signal. It is directly logic compatible and can be driven with any signal between 10% and 90% duty cycle. If unused, the pin should be connected to GND.

**SS\_MAXDC (Pin 13):** The external resistor divider from  $V_{REF}$  sets the maximum duty cycle clamp ( $SS\_MAXDC = 1.84V$ ,  $SD\_V_{SEC} = 1.32V$  gives 72% duty cycle). Capacitor on SS\_MAXDC pin in combination with external resistor divider sets soft-start timing.

**$V_{REF}$  (Pin 14):** The output of an internal 2.5V reference which supplies internal control circuitry. Capable of sourcing up to 2.5mA drive for external use. Bypass to GND with a 0.1 $\mu$ F ceramic capacitor.

**SD\_VSEC (Pin 15):** The  $SD\_V_{SEC}$  pin, when pulled below its accurate 1.32V threshold, is used to turn off the IC and reduce current drain from  $V_{IN}$ . The  $SD\_V_{SEC}$  pin is connected to system input voltage through a resistor divider to define undervoltage lockout (UVLO) for the power supply and to provide a volt-second clamp on the OUT pin. An 11 $\mu$ A pin current hysteresis allows external programming of UVLO hysteresis.

**GND (Pin 16):** Analog Ground. Tie to  $V_{NEG}$ .

**BLANK (Pin 17):** A resistor to GND adjusts the extended blanking period of the overcurrent and current sense amplifier outputs during FET turn-on—to prevent false current limit trip. Increasing the resistor value increases the blanking period.

**$I_{SENSE}$  (Pin 18):** The Current Sense Input for the Control Loop. Connect this pin to the sense resistor in the source of the external power MOSFET. A resistor in series with the  $I_{SENSE}$  pin programs slope compensation.

## PIN FUNCTIONS

**OC (Pin 19):** OC is an accurate 107mV threshold, independent of duty cycle, for overcurrent detection and trigger of soft-start. Connect this pin directly to the sense resistor in the source of the external power MOSFET.

**DELAY (Pin 20):** A resistor to GND adjusts the delay period between SOUT rising edge and OUT rising edge. Used to maximize efficiency in forward converter applications by adjusting the timing. Increasing the resistor value increases the delay period.

**PGND (Pin 21):** Power Ground. Carries the gate driver's return current. Tie to  $V_{NEG}$ .

**OUT (Pin 22):** Drives the gate of an N-channel MOSFET between 0V and  $V_{IN}$  with a maximum limit of 13V on OUT pin set by an internal clamp. Active pull-off exists in shutdown (see electrical specification).

**$V_{IN}$  (Pin 23):** Input Supply for the Power Supply Controller. It must be closely decoupled to GND. An internal undervoltage lockout threshold exists for  $V_{IN}$  at approximately 14.25V on and 8.75V off.

**SOUT (Pin 24):** Switched Output in Phase with OUT Pin. Provides sync signal for control of secondary-side FETs in forward converter applications requiring highly efficient synchronous rectification. SOUT is actively clamped to 12V. Active pull-off exists in shutdown (see electrical specification). Can also be used to drive the active clamp FET of an active clamp forward supply.

**$V_{NEG}$  (Pins 26, 27):** Power Output. Connects the PoE return line to the power supply through the internal Hot Swap power MOSFET. Pins 26 and 27 must be electrically tied together at the package.

**PWRGD (Pin 28):** Active High Power Good Output, Open Collector. Signals that the internal Hot Swap MOSFET is on. High Impedance indicates power is good. PWRGD is referenced to  $V_{NEG}$  and is low impedance during inrush and in the event of thermal overload. PWRGD is clamped 14V above  $V_{NEG}$ .

**$\overline{\text{PWRGD}}$  (Pin 29):** Active Low Power Good Output, Open Drain. Signals that the internal Hot Swap MOSFET is on. Low Impedance indicates power is good.  $\overline{\text{PWRGD}}$  is referenced to  $V_{PORTN}$  and is high impedance during inrush and in the event of thermal overload.  $\overline{\text{PWRGD}}$  has no internal clamps.

**$V_{PORTP}$  (Pin 32):** Input Voltage Positive Rail. This pin is connected to the PD's positive rail.

**Exposed Pad (Pin 33):** Tie to GND and PCB heat sink.

**BLOCK DIAGRAMS**

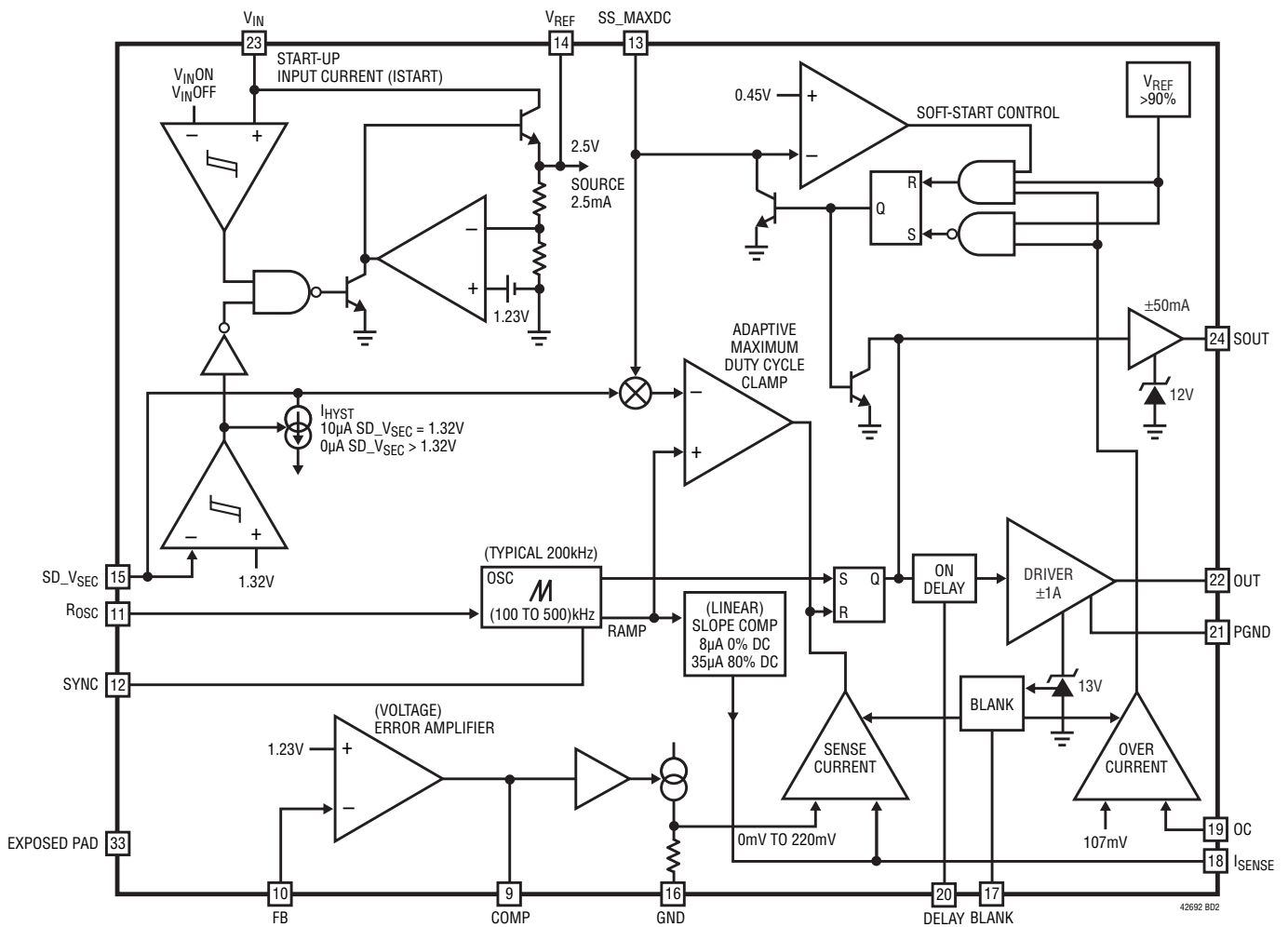
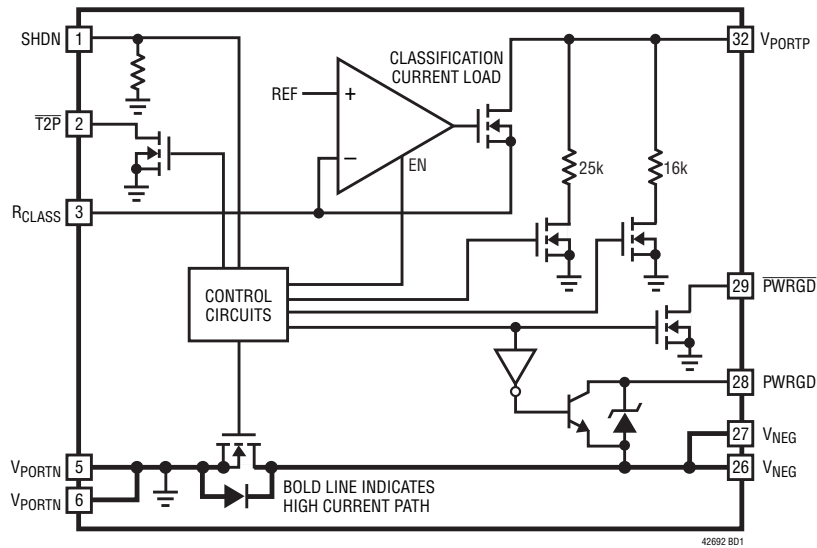

## APPLICATIONS INFORMATION

### OVERVIEW

Power over Ethernet (PoE) continues to gain popularity as more products are taking advantage of having DC power and high speed data available from a single RJ45 connector. As PoE continues to grow in the marketplace, Powered Device (PD) equipment vendors are running into the 12.95W power limit established by the IEEE 802.3af standard.

The IEEE 802.3at standard establishes a higher power allocation for Power over Ethernet while maintaining backwards compatibility with the existing IEEE 802.3af systems. Power Sourcing Equipment (PSE) and Powered Devices are distinguished as Type 1 complying with the IEEE 802.3af power levels, or Type 2 complying with the IEEE 802.3at power levels. The maximum available power of a Type 2 PD is 25.5W.

The IEEE 802.3at standard also establishes a new method of acquiring power classification from a PD and communicating the presence of a Type 2 PSE. A Type 2 PSE has the option of acquiring PD power classification by performing 2-event classification (Layer 1) or by communicating with the PD over the data line (Layer 2). In turn, a Type 2 PD must be able to recognize both layers of communications and identify a Type 2 PSE.

The LTC4269-2 is specifically designed to support a PD that must operate under the IEEE 802.3at standard. In particular, the LTC4269-2 provides the  $\overline{T2P}$  indicator bit which recognizes 2-event classification. This indicator bit may be used to alert the LTC4269-2 output load that a Type 2 PSE is present. With an internal signature resistor, classification circuitry, inrush control, and thermal shutdown, the LTC4269-2 is a complete PD interface solution capable of supporting in the next generation PD applications. In addition to the PD front end, the LTC4269-2 also incorporates a high efficiency synchronous forward controller that minimizes component sizes while maximizing output power.

### MODES OF OPERATION

The LTC4269-2 has several modes of operation depending on the input voltage applied between the  $V_{PORTP}$  and  $V_{PORTN}$  pins. Figure 1 presents an illustration of voltage

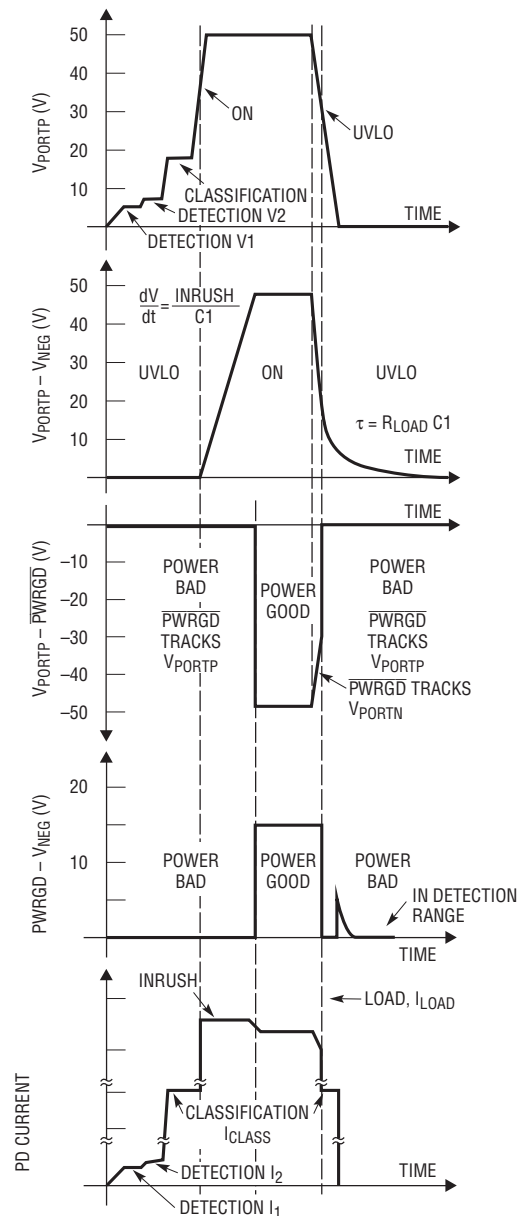

$$I_1 = \frac{V_1 - 2 \text{ DIODE DROPS}}{25k\Omega} \quad I_2 = \frac{V_2 - 2 \text{ DIODE DROPS}}{25k\Omega}$$

$I_{CLASS}$  DEPENDENT ON  $R_{CLASS}$  SELECTION

INRUSH = 100mA

$$I_{LOAD} = \frac{V_{PORTP}}{R_{LOAD}}$$

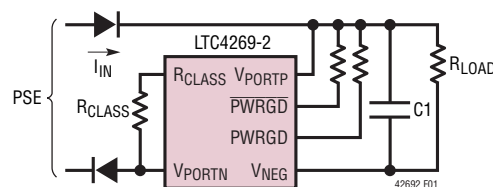

Figure 1. Output Voltage,  $\overline{PWRGD}$ , PWRGD and PD Current as a Function of Input Voltage

## APPLICATIONS INFORMATION

and current waveforms the LTC4269-2 may encounter with the various modes of operation summarized in Table 1.

**Table 1. LTC4269-2 Modes of Operation as a Function of Input Voltage**

$V_{PORTP} - V_{PORTN}$ (V)	LTC4269-2 MODES OF OPERATION
0V to 1.4V	Inactive (Reset after 1st Classification Event)
1.5V to 9.8V (5.4V to 9.8V)	25k Signature Resistor Detection Before 1st Classification Event (Mark, 11k Signature Corrupt After 1st Classification Event)
12.5V to On/UVLO	Classification Load Current Active
On/UVLO to 60V	Inrush and Power Applied to PD Load
>71V	Oversvoltage Lockout, Classification and Hot Swap are Disabled.

On/UVLO includes hysteresis. Rising input threshold: 37.2V max. Falling input threshold: 30.0V min.

These modes satisfy the requirements defined in the IEEE 802.3af/at specification.

### INPUT DIODE BRIDGE

In the IEEE 802.3af/at standard, the modes of operation reference the input voltage at the PD's RJ45 connector. Since the PD must handle power received in either polarity from either the data or the spare pair, input diode bridges BR1 and BR2 are connected between the RJ45 connector and the LTC4269-2 (Figure 2).

The input diode bridge introduces a voltage drop that affects the range for each mode of operation. The LTC4269-2 compensates for these voltage drops so that a PD built with the LTC4269-2 meets the IEEE 802.3af/at-established

voltage ranges. Note that the Electrical Specifications are referenced with respect to the LTC4269-2 package pins.

### DETECTION

During detection, the PSE looks for a 25k signature resistor which identifies the device as a PD. The PSE will apply two voltages in the range of 2.8V to 10V and measures the corresponding currents. Figure 1 shows the detection voltages V1 and V2 and the corresponding PD current. The PSE calculates the signature resistance using the  $\Delta V/\Delta I$  measurement technique.

The LTC4269-2 presents its precision, temperature-compensated 25k resistor between the  $V_{PORTP}$  and  $V_{PORTN}$  pins, alerting the PSE that a PD is present and requests power to be applied. The LTC4269-2 signature resistor also compensates for the additional series resistance introduced by the input diode bridge. Thus a PD built with the LTC4269-2 conforms to the IEEE 802.3af/at detection specifications.

### SIGNATURE CORRUPT OPTION

In some designs that include an auxiliary power option, it is necessary to prevent a PD from being detected by a PSE. The LTC4269-2 signature resistance can be corrupted with the SHDN pin (Figure 3). Taking the SHDN pin high will reduce the signature resistor below 11k which is an invalid signature per the IEEE 802.3af/at specifications, and alerts the PSE not to apply power. Invoking the SHDN pin

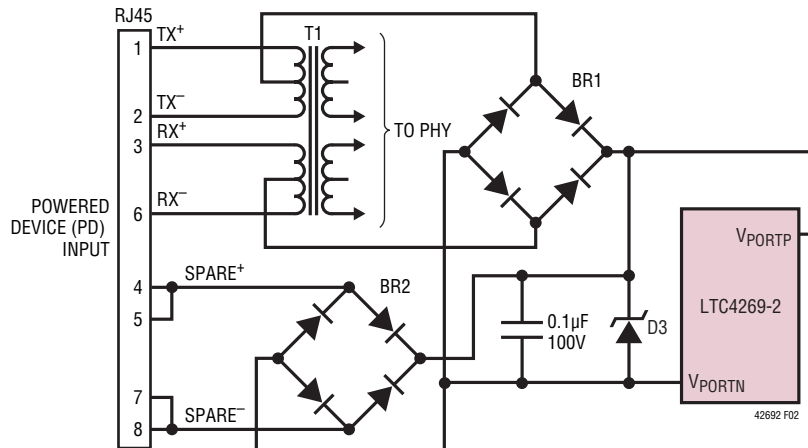

**Figure 2. PD Front End Using Diode Bridge on Main and Spare Inputs**

## APPLICATIONS INFORMATION

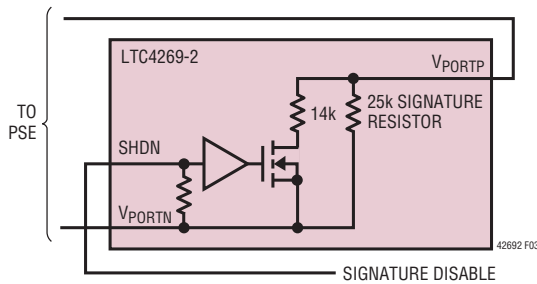

Figure 3. 25k Signature Resistor with Disable

also ceases operation for classification and turns off the internal Hot Swap FET. If this feature is not used, connect SHDN to VPORTN.

### CLASSIFICATION

Classification provides a method for more efficient power allocation by allowing the PSE to identify a PD power classification. Class 0 is included in the IEEE specification for PDs that don't support classification. Class 1-3 partitions PDs into three distinct power ranges. Class 4 includes the new power range under IEEE 802.3at (see Table 2).

During classification probing, the PSE presents a fixed voltage between 15.5V and 20.5V to the PD (Figure 1). The LTC4269-2 asserts a load current representing the PD power classification. The classification load current is programmed with a resistor R<sub>CLASS</sub> that is chosen from Table 2.

Table 2. Summary of Power Classifications and LTC4269-2 R<sub>CLASS</sub> Resistor Selection

CLASS	USAGE	MAXIMUM POWER LEVELS AT INPUT OF PD (W)	NOMINAL CLASSIFICATION LOAD CURRENT (mA)	LTC4269-2 R <sub>CLASS</sub> RESISTOR (Ω, 1%)
0	Type 1	0.44 to 12.95	<0.4	Open
1	Type 1	0.44 to 3.84	10.5	124
2	Type 1	3.84 to 6.49	18.5	69.8
3	Type 1	6.49 to 12.95	28	45.3
4	Type 2	12.95 to 25.5	40	30.9

### 2-EVENT CLASSIFICATION AND THE T2P PIN

A Type 2 PSE may declare the availability of high power by performing a 2-event classification (Layer 1) or by communicating over the high speed data line (Layer 2). A Type 2 PD must recognize both layers of communication. Since

Layer 2 communications takes place directly between the PSE and the PD, the LTC4269-2 concerns itself only with recognizing 2-event classification.

In 2-event classification, a Type 2 PSE probes for power classification twice. Figure 4 presents an example of a 2-event classification. The 1st classification event occurs

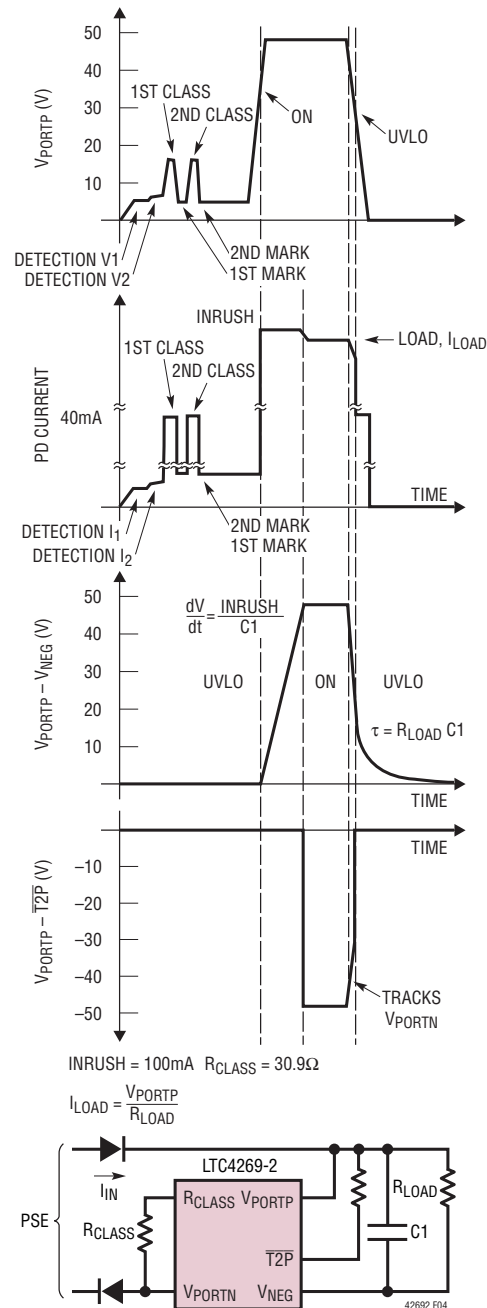

Figure 4. V<sub>NEG</sub>, T2P and PD Current as a Result of 2-Event Classification

42692fb



## APPLICATIONS INFORMATION

when the PSE presents an input voltage between 15.5V to 20.5V and the LTC4269-2 presents a Class 4 load current. The PSE then drops the input voltage into the mark voltage range of 7V to 10V, signaling the 1st mark event. The PD in the mark voltage range presents a load current between 0.25mA to 4mA.

The PSE repeats this sequence, signaling the 2nd Classification and 2nd mark event occurrence. This alerts the LTC4269-2 that a Type 2 PSE is present. The Type 2 PSE then applies power to the PD and the LTC4269-2 charges up the reservoir capacitor C1 with a controlled inrush current. When C1 is fully charged, and the LTC4269-2 declares power good, the  $\overline{T2P}$  pin presents an active low signal, or low impedance output with respect to  $V_{PORTN}$ . The  $\overline{T2P}$  output becomes inactive when the LTC4269-2 input voltage falls below the PoE undervoltage lockout threshold.

### SIGNATURE CORRUPT DURING MARK

As a member of the IEEE 802.3at working group, Linear noted that it is possible for a Type 2 PD to receive a false indication of a 2-event classification if a PSE port is pre-charged to a voltage above the detection voltage range before the first detection cycle. The IEEE working group modified the standard to prevent this possibility by requiring a Type 2 PD to corrupt the signature resistance during the mark event, alerting the PSE not to apply power. The LTC4269-2 conforms to this standard by internally corrupting the signature resistance. This also discharges the port before the PSE begins the next detection cycle.

### PD STABILITY DURING CLASSIFICATION

Classification presents a challenging stability problem due to the wide range of possible classification load current. The onset of the classification load current introduces a voltage drop across the cable and increases the forward voltage of the input diode bridge. This may cause the PD to oscillate between detection and classification with the onset and removal of the classification load current.

The LTC4269-2 prevents this oscillation by introducing a voltage hysteresis window between the detection and classification ranges. The hysteresis window accommodates

the voltage changes a PD encounters at the onset of the classification load current, thus providing a trouble-free transition between detection and classification modes.

The LTC4269-2 also maintains a positive I-V slope throughout the classification range up to the on voltage. In the event a PSE overshoots beyond the classification voltage range, the available load current aids in returning the PD back into the classification voltage range. (The PD input may otherwise be “trapped” by a reverse-biased diode bridge and the voltage held by the 0.1 $\mu$ F capacitor.)

### INRUSH CURRENT

Once the PSE detects and optionally classifies the PD, the PSE then applies power to the PD. When the LTC4269-2 port voltage rises above the on voltage threshold, LTC4269-2 connects  $V_{NEG}$  to  $V_{PORTN}$  through the internal power MOSFET.

To control the power-on surge currents in the system, the LTC4269-2 provides a fixed inrush current, allowing C1 to ramp up to the line voltage in a controlled manner.

The LTC4269-2 keeps the PD inrush current below the PSE current limit to provide a well-controlled power-up characteristic that is independent of the PSE behavior. This ensures a PD using the LTC4269-2 interoperability with any PSE.

### POE UNDERVOLTAGE LOCKOUT

The IEEE 802.3af/at specification for the PD dictates a maximum turn-on voltage of 42V and a minimum turn-off voltage of 30V. This specification provides an adequate voltage to begin PD operation, and to discontinue PD operation when the port voltage is too low. In addition, this specification allows PD designs to incorporate an on-off hysteresis window to prevent start-up oscillations.

The LTC4269-2 features a PoE undervoltage lockout (UVLO) hysteresis window (See Figure 5) that conforms with the IEEE 802.3af/at specification and accommodates the voltage drop in the cable and input diode bridge at the onset of the inrush current.

Once C1 is fully charged, the LTC4269-2 turns on its internal MOSFET and passes power to the PD. The LTC4269-2

## APPLICATIONS INFORMATION

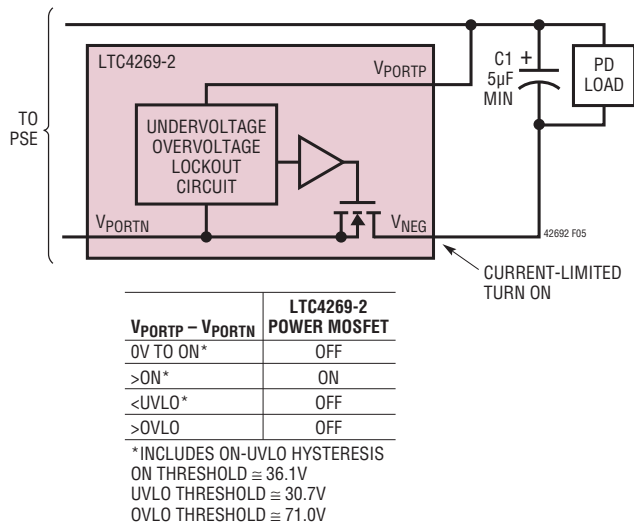

Figure 5. LTC4269-2 Undervoltage and Overvoltage Lockout

continues to power the PD load as long as the port voltage does not fall below the UVLO threshold. When the LTC4269-2 port voltage falls below the UVLO threshold, the PD is disconnected, and classification mode resumes. C1 discharges through the LTC4269-2 circuitry.

### COMPLEMENTARY POWER GOOD

When LTC4269-2 fully charges the load capacitor (C1), power good is declared and the LTC4269-2 load can safely begin operation. The LTC4269-2 provides complementary power good signals that remain active during normal operation and are deasserted when the port voltage falls below the PoE UVLO threshold, when the voltage exceeds the overvoltage lockout (OVLO) threshold, or in the event of a thermal shutdown. See Figure 6.

The PWRGD pin features an open-collector output referenced to  $V_{NEG}$  which can interface directly with the  $SD\_V_{SEC}$  pin. When power good is declared and active, the PWRGD pin is high impedance with respect to  $V_{NEG}$ . An internal 14V clamp limits the PWRGD pin voltage. Connecting the PWRGD pin to the  $SD\_V_{SEC}$  pin prevents the DC/DC converter from commencing operation before the PDI interface completely charges the reservoir capacitor, C1.

The active low  $\overline{PWRGD}$  pin connects to an internal, open-drain MOSFET referenced to  $V_{PORTN}$  and can interface directly to the shutdown pin of a DC/DC converter product.

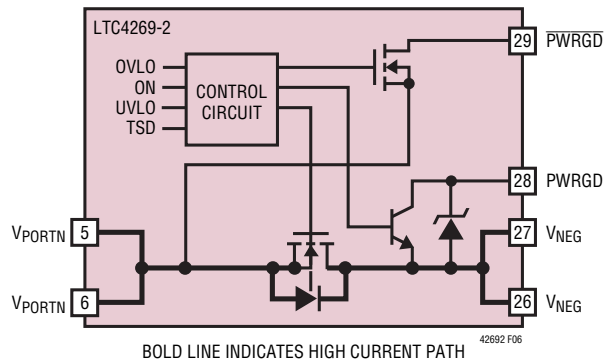

BOLD LINE INDICATES HIGH CURRENT PATH

INRUSH COMPLETE  
ON <  $V_{PORTP}$  < OVLO  
AND NOT IN THERMAL SHUTDOWN

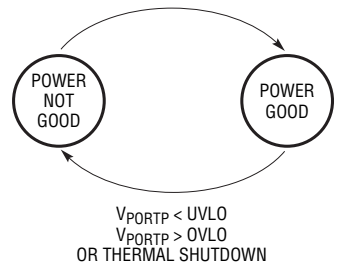

Figure 6. LTC4269-2 Power Good Functional and State Diagram

When power good is declared and active, the  $\overline{PWRGD}$  pin is low impedance with respect to  $V_{PORTN}$ .

### PWRGD PIN WHEN SHDN IS INVOKED

In PD applications where an auxiliary power supply invokes the SHDN feature, the PWRGD pin becomes high impedance. This prevents the PWRGD pin that is connected to the “RUN” pin of the DC/DC converter from interfering with the DC/DC converter operations when powered by an auxiliary power supply.

### OVERVOLTAGE LOCKOUT

The LTC4269-2 includes an Overvoltage Lockout (OVLO) feature (Figure 5) which protects the LTC4269-2 and its load from an overvoltage event. If the input voltage exceeds the OVLO threshold, the LTC4269-2 discontinues PD operation. Normal operations resume when the input voltage falls below the OVLO threshold and when C1 is charged up.



## APPLICATIONS INFORMATION

### THERMAL PROTECTION

The IEEE 802.3af/at specification requires a PD to withstand any applied voltage from 0V to 57V indefinitely. However, there are several possible scenarios where a PD may encounter excessive heating.

During classification, excessive heating may occur if the PSE exceeds the 75ms probing time limit. At turn-on, when the load capacitor begins to charge, the instantaneous power dissipated by the PD interface can be large before it reaches the line voltage. And if the PD experiences a fast input positive voltage step in its operational mode (for example, from 37V to 57V), the instantaneous power dissipated by the PD Interface can be large.

The LTC4269-2 includes a thermal protection feature which protects the LTC4269-2 from excessive heating. If the LTC4269-2 junction temperature exceeds the overtemperature threshold, the LTC4269-2 discontinues PD operations. Normal operation resumes when the junction temperature falls below the overtemperature threshold and when C1 is charged up and power good becomes inactive.

### EXTERNAL INTERFACE AND COMPONENT SELECTION

#### Transformer

Nodes on an Ethernet network commonly interface to the outside world via an isolation transformer. For PDs, the isolation transformer must also include a center tap on the RJ45 connector side (see Figure 7).

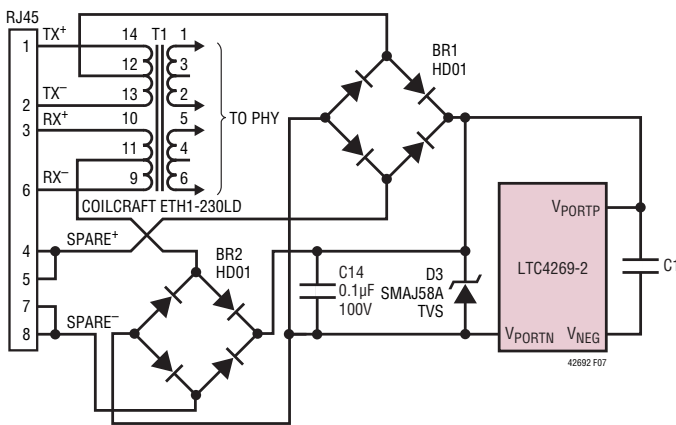

**Figure 7. PD Front End with Isolation Transformer, Diode Bridges, Capacitors and a Transient Voltage Suppressor (TVS)**

The increased current levels in a Type 2 PD over a Type 1 increase the current imbalance in the magnetics which can interfere with data transmission. In addition, proper termination is also required around the transformer to provide correct impedance matching and to avoid radiated and conducted emissions. Transformer vendors such as Bel Fuse, Coilcraft, Halo, Pulse and Tyco (Table 4) can assist in selecting an appropriate isolation transformer and proper termination methods.

**Table 4. Power over Ethernet Transformer Vendors**

VENDOR	CONTACT INFORMATION
Bel Fuse Inc.	206 Van Vorst Street Jersey City, NJ 07302 Tel: 201-432-0463 www.belfuse.com
Coilcraft Inc.	1102 Silver Lake Road Gary, IL 60013 Tel: 847-639-6400 www.coilcraft.com
Halo Electronics	1861 Landings Drive Mountain View, CA 94043 Tel: 650-903-3800 www.haloelectronics.com
PCA Electronics	16799 Schoenborn Street North Hills, CA 91343 Tel: 818-892-0761 www.pca.com
Pulse Engineering	12220 World Trade Drive San Diego, CA 92128 Tel: 858-674-8100 www.pulseeng.com
Tyco Electronics	308 Constitution Drive Menlo Park, CA 94025-1164 Tel: 800-227-7040 www.circuitprotection.com

#### Input Diode Bridge

Figure 2 shows how two diode bridges are typically connected in a PD application. One bridge is dedicated to the data pair while the other bridge is dedicated to the spare pair. The LTC4269-2 supports the use of either silicon or Schottky input diode bridges. However, there are trade-offs in the choice of diode bridges.

An input diode bridge must be rated above the maximum current the PD application will encounter at the temperature the PD will operate. Diode bridge vendors typically call out the operating current at room temperature, but derate the maximum current with increasing temperature. Consult the diode bridge vendors for the operating current de-rating curve.

## APPLICATIONS INFORMATION

A silicon diode bridge can consume over 4% of the available power in some PD applications. Using Schottky diodes can help reduce the power loss with a lower forward voltage.

A Schottky bridge may not be suitable for some high temperature PD applications. The leakage current has a temperature and voltage dependency that can reduce the perceived signature resistance. In addition, the IEEE 802.3af/at specification mandates the leakage back-feeding through the unused bridge cannot generate more than 2.8V across a 100k resistor when a PD is powered with 57V.

### Sharing Input Diode Bridges

At higher temperatures, a PD design may be forced to consider larger bridges in a bigger package because the maximum operating current for the input diode bridge is drastically derated. The larger package may not be acceptable in some space-limited environments.

One solution to consider is to reconnect the diode bridges so that only one of the four diodes conducts current in each package. This configuration extends the maximum operating current while maintaining a smaller package profile. Figure 7 shows how to reconnect the two diode bridges. Consult the diode bridge vendors for the de-rating curve when only one of four diodes is in operation.

### Input Capacitor

The IEEE 802.3af/at standard includes an impedance requirement in order to implement the AC disconnect function. A 0.1 $\mu$ F capacitor (C14 in Figure 7) is used to meet this AC impedance requirement. Place this capacitor as close to the LTC4269-2 as possible.

### Transient Voltage Suppressor

The LTC4269-2 specifies an absolute maximum voltage of 100V and is designed to tolerate brief overvoltage events. However, the pins that interface to the outside world can routinely see excessive peak voltages. To protect the LTC4269-2, install a transient voltage suppressor (D3) between the input diode bridge and the LTC4269-2 as close to the LTC4269-2 as possible as shown in Figure 7.

### Classification Resistor ( $R_{CLASS}$ )

The  $R_{CLASS}$  resistor sets the classification load current, corresponding to the PD power classification. Select the value of  $R_{CLASS}$  from Table 2 and connect the resistor between the  $R_{CLASS}$  and  $V_{PORTN}$  pins as shown in Figure 4, or float the  $R_{CLASS}$  pin if the classification load current is not required. The resistor tolerance must be 1% or better to avoid degrading the overall accuracy of the classification circuit.

### Load Capacitor

The IEEE 802.3af/at specification requires that the PD maintains a minimum load capacitance of 5 $\mu$ F and does not specify a maximum load capacitor. However, if the load capacitor is too large, there may be a problem with inadvertent power shutdown by the PSE.

This occurs when the PSE voltage drops quickly. The input diode bridge reverses bias, and the PD load momentarily powers off the load capacitor. If the PD does not draw power within the PSE's 300ms disconnection delay, the PSE may remove power from the PD. Thus, it is necessary to evaluate the load current and capacitance to ensure that an inadvertent shutdown cannot occur.

The load capacitor can store significant energy when fully charged. The PD design must ensure that this energy is not inadvertently dissipated in the LTC4269-2. For example, if the  $V_{PORTP}$  pin shorts to  $V_{PORTN}$  while the capacitor is charged, current will flow through the parasitic body diode of the internal MOSFET and may cause permanent damage to the LTC4269-2.

### $\overline{T2P}$ Interface

When a 2-event classification sequence successfully completes, the LTC4269-2 recognizes this sequence, and provides an indicator bit, declaring the presence of a Type 2 PSE. The open-drain output provides the option to use this signal to communicate to the LTC4269-2 load, or to leave the pin unconnected.

Figure 8 shows two interface options using the  $\overline{T2P}$  pin and the opto-isolator. The  $\overline{T2P}$  pin is active low and connects to an optoisolater to communicate across the

## APPLICATIONS INFORMATION

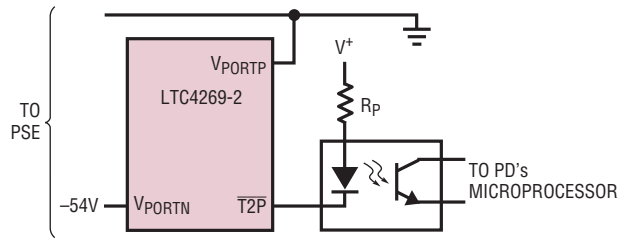

OPTION 1: SERIES CONFIGURATION FOR ACTIVE LOW/LOW IMPEDANCE OUTPUT

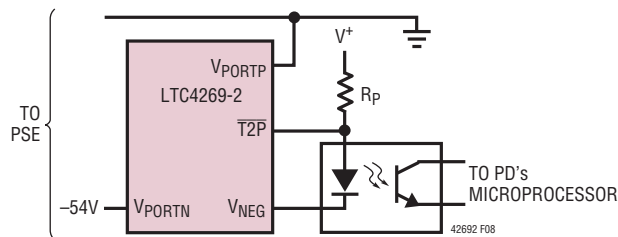

OPTION 2: SHUNT CONFIGURATION FOR ACTIVE HIGH/OPEN COLLECTOR OUTPUT

Figure 8.  $\overline{T2P}$  Interface Examples

DC/DC converter isolation barrier. The pull-up resistor  $R_p$  is sized according to the requirements of the opto-isolator operating current, the pull-down capability of the  $\overline{T2P}$  pin, and the choice of  $V^+$ .  $V^+$  for example can come from the PoE supply rail (which the LTC4269-2  $V_{PORTP}$  is tied to), or from the voltage source that supplies power to the DC/DC converter. Option 1 has the advantage of not drawing power unless  $\overline{T2P}$  is declared active.

### Shutdown Interface

To corrupt the signature resistance, the SHDN pin can be driven high with respect to  $V_{PORTN}$ . If unused, connect SHDN directly to  $V_{PORTN}$ .

### Exposed Pad

The LTC4269-2 uses a thermally enhanced DFN12 package that includes an Exposed Pad. The Exposed Pad should be electrically connected to the GND pin's PCB copper plane. This plane should be large enough to serve as the heat sink for the LTC4269-2.

### Auxiliary Power Source

In some applications, it is desirable to power the PD from an auxiliary power source such as a wall adapter. Auxiliary power can be injected into the PD at several locations with priority chosen between PoE or auxiliary power sources.

These options come with various trade-offs and design considerations. Contact Linear Technology applications support for detailed information on implementing custom auxiliary power sources.

### IEEE 802.3AT SYSTEM POWER-UP REQUIREMENT

Under the IEEE 802.3at standard, a PD must operate under 12.95W in accordance with IEEE 802.3at standard until it recognizes a Type 2 PSE. Initializing PD operation in 12.95W mode eliminates interoperability issue in case a Type 2 PD connects to a Type 1 PSE. Once the PD recognizes a Type 2 PSE, the IEEE 802.3at standard requires the PD to wait 80ms in 12.95W operation before 25.5W operation can commence.

### MAINTAIN POWER SIGNATURE

In an IEEE 802.3af/at system, the PSE uses the maintain power signature (MPS) to determine if a PD continues to require power. The MPS requires the PD to periodically draw at least 10mA and also have an AC impedance less than 26.25k in parallel with 0.05 $\mu$ F. If one of these conditions is not met, the PSE may disconnect power to the PD.

### Isolation

The 802.3 standard requires Ethernet ports to be electrically isolated from all other conductors that are user accessible. This includes the metal chassis, other connectors, and any auxiliary power connection. For PDs, there are two common methods to meet the isolation requirement. If there are any user-accessible connections to the PD, then an isolated DC/DC converter is necessary to meet the isolation requirements. If user connections can be avoided, then it is possible to meet the safety requirement by completely enclosing the PD in an insulated housing.

### Switcher Controller Operation

The LTC4269-2 has a current mode synchronous PWM controller optimized for control of a forward converter topology. The LTC4269-2 is ideal for power systems where very high efficiency and reliability, low complexity and cost are required in a small space. Key features of the LTC4269-2 include an adaptive maximum duty cycle clamp.

## APPLICATIONS INFORMATION

An additional output signal is included for synchronous rectifier control or active clamp control. A precision 107mV threshold senses overcurrent conditions and triggers soft-start for low stress short-circuit protection and control. The key functions of the LTC4269-2 PWM controller are shown in the Block Diagrams.

### Part Start-Up

In normal operation, the SD\_V<sub>SEC</sub> pin must exceed 1.32V and the V<sub>IN</sub> pin must exceed 14.25V to allow the part to turn on. This combination of pin voltages allows the 2.5V V<sub>REF</sub> pin to become active, supplying the LTC4269-2 control circuitry and providing up to 2.5mA external drive. SD\_V<sub>SEC</sub> threshold can be used for externally programming the power supply undervoltage lockout (UVLO) threshold on the input voltage to the forward converter. Hysteresis on the UVLO threshold can also be programmed since the SD\_V<sub>SEC</sub> pin draws 11μA just before part turn-on and 0μA after part turn-on.

With the LTC4269-2 turned on, the V<sub>IN</sub> pin can drop as low as 8.75V before part shutdown occurs. This V<sub>IN</sub> pin hysteresis (5.5V) combined with low 460μA start-up input current allows low power start-up using a resistor/capacitor network from power supply input voltage to supply the V<sub>IN</sub> pin (Figure 10). The V<sub>IN</sub> capacitor value is chosen to prevent V<sub>IN</sub> falling below its turn-off threshold before a bias winding in the converter takes over supply to the V<sub>IN</sub> pin.

### Output Drivers

The LTC4269-2 has two outputs, SOUT and OUT. The OUT pin provides a ±1A peak MOSFET gate drive clamped to 13V. The SOUT pin has a ±50mA peak drive clamped to 12V and provides sync signal timing for synchronous rectification control or active clamp control.

For SOUT and OUT turn-on, a PWM latch is set at the start of each main oscillator cycle. OUT turn-on is delayed from SOUT turn-on by a time, t<sub>DELAY</sub> (Figure 14). t<sub>DELAY</sub> is programmed using a resistor from the DELAY pin to GND and is used to set the timing control of the secondary synchronous rectifiers for optimum efficiency.

SOUT and OUT turn off at the same time each cycle by one of three methods:

- (1) MOSFET peak current sense at I<sub>SENSE</sub> pin
- (2) Adaptive maximum duty cycle clamp reached during load/line transients
- (3) Maximum duty cycle reset of the PWM latch

During any of the following conditions—low V<sub>IN</sub>, low SD\_V<sub>SEC</sub> or overcurrent detection at the OC pin—a soft-start event is latched and both SOUT and OUT turn off immediately (Figure 11).

### Leading Edge Blanking

To prevent MOSFET switching noise causing premature turn-off of SOUT or OUT, programmable leading edge blanking exists. This means both the current sense comparator and overcurrent comparator outputs are ignored during MOSFET turn-on and for an extended period after the OUT leading edge (Figure 12). The extended blanking period is programmable by adjusting a resistor from the BLANK pin to GND.

### Adaptive Maximum Duty Cycle Clamp (Volt-Second Clamp)

For forward converter applications, a maximum switch duty cycle clamp which adapts to transformer input voltage is necessary for reliable control of the MOSFET. This volt-second clamp provides a safeguard for transformer reset that prevents transformer saturation. Instantaneous load changes can cause the converter loop to demand maximum duty cycle. If the maximum duty cycle of the switch is too great, the transformer reset voltage can exceed the voltage rating of the primary-side MOSFETs with catastrophic damage. Many converters solve this problem by limiting the operational duty cycle of the MOSFET to 50% or less—or by using a fixed (non-adaptive) maximum duty cycle clamp with very large voltage rated MOSFETs. The LTC4269-2 provides a volt-second clamp to allow MOSFET duty cycles well above 50%. This gives greater power utilization for the MOSFETs, rectifiers and transformer resulting in less space for a given power output. In addition, the volt-second clamp can allow a reduced voltage rating on the MOSFET resulting in lower R<sub>DS(ON)</sub> for greater efficiency. The volt-second clamp defines a maximum duty cycle ‘guard rail’ which falls when power supply input voltage increases.



## APPLICATIONS INFORMATION

An increase of voltage at the SD\_VSEC pin causes the maximum duty cycle clamp to decrease. If SD\_VSEC is resistively divided down from power supply input voltage, a volt-second clamp is realized. To adjust the initial maximum duty cycle clamp, the SS\_MAXDC pin voltage is programmed by a resistor divider from the 2.5V VREF pin to GND. An increase of programmed voltage on SS\_MAXDC pin provides an increase of switch maximum duty cycle clamp.

### Soft-Start

The LTC4269-2 provides true PWM soft-start by using the SS\_MAXDC pin to control soft-start timing. The proportional relationship between SS\_MAXDC voltage and switch maximum duty cycle clamp allows the SS\_MAXDC pin to slowly ramp output voltage by ramping the maximum switch duty cycle clamp—until switch duty cycle clamp seamlessly meets the natural duty cycle of the converter. A soft-start event is triggered whenever V<sub>IN</sub> is too low, SD\_VSEC is too low (power supply UVLO), or a 107mV overcurrent threshold at OC pin is exceeded. Whenever a soft-start event is triggered, switching at SOUT and OUT is stopped immediately.

The SS\_MAXDC pin is discharged and only released for charging when it has fallen below its reset threshold of 0.45V and all faults have been removed. Increasing voltage on the SS\_MAXDC pin above 0.8V will increase switch maximum duty cycle. A capacitor to GND on the SS\_MAXDC pin in combination with a resistor divider from V<sub>REF</sub>, defines the soft-start timing.

### Current Mode Topology (I<sub>SENSE</sub> Pin)

The LTC4269-2 current mode topology eases frequency compensation requirements because the output inductor does not contribute to phase delay in the regulator loop. This current mode technique means that the error amplifier (nonisolated applications) or the opto-coupler (isolated applications) commands current (rather than voltage) to be delivered to the output. This makes frequency compensation easier and provides faster loop response to output load transients.

A resistor divider from the application's output voltage generates a voltage at the inverting FB input of the LTC4269-2 error amplifier (or to the input of an external opto-coupler) and is compared to an accurate reference (1.23V for LTC4269-2). The error amplifier output (COMP) defines the input threshold (I<sub>SENSE</sub>) of the current sense comparator. COMP voltages between 0.8V (active threshold) and 2.5V define a maximum I<sub>SENSE</sub> threshold from 0mV to 220mV. By connecting I<sub>SENSE</sub> to a sense resistor in series with the source of an external power MOSFET, the MOSFET peak current trip point (turn off) can be controlled by COMP level and hence by the output voltage. An increase in output load current causing the output voltage to fall, will cause COMP to rise, increasing I<sub>SENSE</sub> threshold, increasing the current delivered to the output. For isolated applications, the error amplifier COMP output can be disabled to allow the opto-coupler to take control. Setting FB = V<sub>REF</sub> disables the error amplifier COMP output, reducing pin current to (COMP – 0.7)/40k.

### Slope Compensation

The current mode architecture requires slope compensation to be added to the current sensing loop to prevent subharmonic oscillations which can occur for duty cycles above 50%. Unlike most current mode converters which have a slope compensation ramp that is fixed internally, placing a constraint on inductor value and operating frequency, the LTC4269-2 has externally adjustable slope compensation. Slope compensation can be programmed by inserting an external resistor (R<sub>SLOPE</sub>) in series with the I<sub>SENSE</sub> pin. The LTC4269-2 has a linear slope compensation ramp which sources current out of the I<sub>SENSE</sub> pin of approximately 8μA at 0% duty cycle to 35μA at 80% duty cycle.

### Overcurrent Detection and Soft-Start (OC Pin)

An added feature to the LTC4269-2 is a precise 107mV sense threshold at the OC pin used to detect overcurrent conditions in the converter and set a soft-start latch. The OC pin is connected directly to the source of the primary-side MOSFET to monitor peak current in the MOSFET (Figure 13). The 107mV threshold is constant over the entire duty cycle range of the converter because it is unaffected by the slope compensation added to the I<sub>SENSE</sub> pin.

## APPLICATIONS INFORMATION

### Synchronizing

A SYNC pin allows the LTC4269-2 oscillator to be synchronized to an external clock. The SYNC pin can be driven from a logic-level output, requiring less than 0.8V for a logic-level low and greater than 2.2V for a logic-level high. Duty cycle should run between 10% and 90%. To avoid loss of slope compensation during synchronization, the free running oscillator frequency,  $f_{OSC}$ , should be programmed to 80% of the external clock frequency ( $f_{SYNC}$ ). The  $R_{SLOPE}$  resistor chosen for nonsynchronized operation should be increased by  $1.25\times (= f_{SYNC}/f_{OSC})$ .

### Shutdown and Programming the Power Supply Undervoltage Lockout

The LTC4269-2 has an accurate 1.32V shutdown threshold at the  $SD\_V_{SEC}$  pin. This threshold can be used in conjunction with a resistor divider to define the power supply undervoltage lockout threshold (UVLO) of the power supply input voltage ( $V_S$ ) (Figure 9). A pin current hysteresis ( $11\mu A$  before part turn-on,  $0\mu A$  after part turn-on) allows power supply UVLO hysteresis to be programmed. Calculation of the on/off thresholds for the power supply input voltage can be made as follows:

$$V_{S(OFF)} \text{ Threshold} = 1.32[1 + (R1/R2)]$$

$$V_{S(ON)} \text{ Threshold} = V_{S(OFF)} + (11\mu A \cdot R1)$$

Connect the PWRGD pin to the resistive divider network at the  $SD\_V_{SEC}$  pin to prevent the DC/DC converter from starting before the PD interface completely charges the reservoir capacitor, C1 (Figure 9).

The  $SD\_V_{SEC}$  pin must not be left open since there must be an external source current  $>11\mu A$  to lift the pin past its 1.32V threshold for part turn-on.

### Micropower Start-Up: Selection of Start-Up Resistor and Capacitor for $V_{IN}$

The LTC4269-2 uses turn-on voltage hysteresis at the  $V_{IN}$  pin and low start-up current to allow micropower start-up (Figure 10). The LTC4269-2 monitors  $V_{IN}$  pin voltage to allow the part to turn-on at 14.25V and the part to turn-off at 8.75V. Low start-up current ( $460\mu A$ ) allows a large resistor to be connected between the power supply input and  $V_{IN}$ . Once the part is turned on, input current

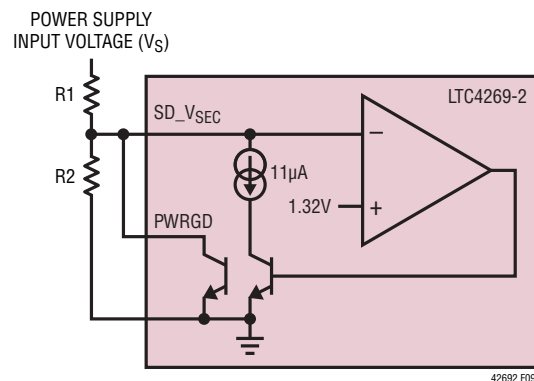
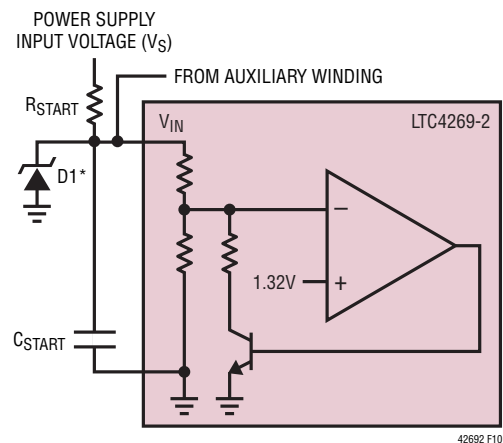

Figure 9. Programming Power Supply Undervoltage Lockout (UVLO)



\*FOR  $V_S > 25V$ , ZENER D1 RECOMMENDED  
( $V_{IN(ONMAX)} < V_Z < 25V$ )

Figure 10. Low Power Start-Up

increases to drive the IC ( $5.2mA$ ) and the output drivers ( $I_{DRIVE}$ ). A large enough capacitor is chosen at the  $V_{IN}$  pin to prevent  $V_{IN}$  falling below its turn-off threshold before a bias winding in the converter takes over supply to  $V_{IN}$ . This technique allows a simple resistor/capacitor for start-up which draws low power from the system supply to the converter.

For system input voltages exceeding the absolute maximum rating of the LTC4269-2  $V_{IN}$  pin, an external Zener should be connected from the  $V_{IN}$  pin to GND. This covers the condition where  $V_{IN}$  charges past  $V_{IN(ON)}$  but the part does not turn on because  $SD\_V_{SEC} < 1.32V$ . In this condition,  $V_{IN}$  will continue to charge towards system  $V_{IN}$ , possibly exceeding the rating for the  $V_{IN}$  pin. The Zener voltage should obey  $V_{IN(ONMAX)} < V_Z < 25V$ .

42692fb

## APPLICATIONS INFORMATION

### Programming Oscillator Frequency

The oscillator frequency ( $f_{OSC}$ ) of the LTC4269-2 is programmed using an external resistor,  $R_{OSC}$ , connected between the  $R_{OSC}$  pin and GND. Figure 11 shows typical  $f_{OSC}$  vs  $R_{OSC}$  resistor values. The LTC4269-2 free-running oscillator frequency is programmable in the range of 100kHz to 500kHz.

Stray capacitance and potential noise pickup on the  $R_{OSC}$  pin should be minimized by placing the  $R_{OSC}$  resistor as close as possible to the  $R_{OSC}$  pin and keeping the area of the  $R_{OSC}$  node as small as possible. The ground side of the  $R_{OSC}$  resistor should be returned directly to the (analog ground) GND pin.  $R_{OSC}$  can be calculated by:

$$R_{OSC} = 9.125k [(4100k/f_{OSC}) - 1]$$

### Programming Leading Edge Blank Time

For PWM controllers driving external MOSFETs, noise can be generated at the source of the MOSFET during gate rise time and some time thereafter. This noise can potentially exceed the OC and  $I_{SENSE}$  pin thresholds of the LTC4269-2 to cause premature turn-off of SOUT and OUT pins in addition to false trigger of soft-start. The LTC4269-2 provides a programmable leading edge blanking of the OC and  $I_{SENSE}$  comparator outputs to avoid false current sensing during MOSFET switching.

Blanking is provided in two phases (Figure 12): The first phase automatically blanks during gate rise time. Gate rise

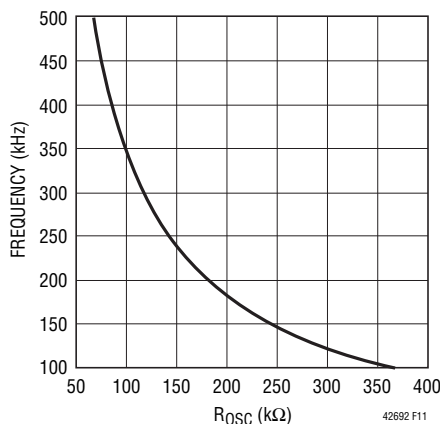

Figure 11. Oscillator Frequency,  $f_{OSC}$ , vs  $R_{OSC}$

times can vary depending on MOSFET type. For this reason the LTC4269-2 performs true 'leading edge blanking' by automatically blanking OC and  $I_{SENSE}$  comparator outputs until OUT rises to within 0.5V of  $V_{IN}$  or reaches its clamp level of 13V. The second phase of blanking starts after the leading edge of OUT has been completed. This phase is programmable by the user with a resistor connected from the BLANK pin to GND. Typical durations for this portion of the blanking period are from 45ns at  $R_{BLANK} = 10k$  to 540ns at  $R_{BLANK} = 120k$ . Blanking duration can be approximated as:

$$\text{Blanking (extended)} = [45(R_{BLANK}/10k)]ns$$

(See graph in the Typical Performance Characteristics section).

### Programming Current Limit (OC Pin)

The LTC4269-2 uses a precise 107mV sense threshold at the OC pin to detect overcurrent conditions in the converter and set a soft-start latch. It is independent of duty cycle because it is not affected by slope compensation programmed at the  $I_{SENSE}$  pin. The OC pin monitors the peak current in the primary MOSFET by sensing the voltage across a sense resistor ( $R_S$ ) in the source of the MOSFET. The overcurrent limit for the converter can be programmed by:

$$\text{Overcurrent limit} = (107mV/R_S)(N_P/N_S) - (1/2)(I_{RIPPLE})$$

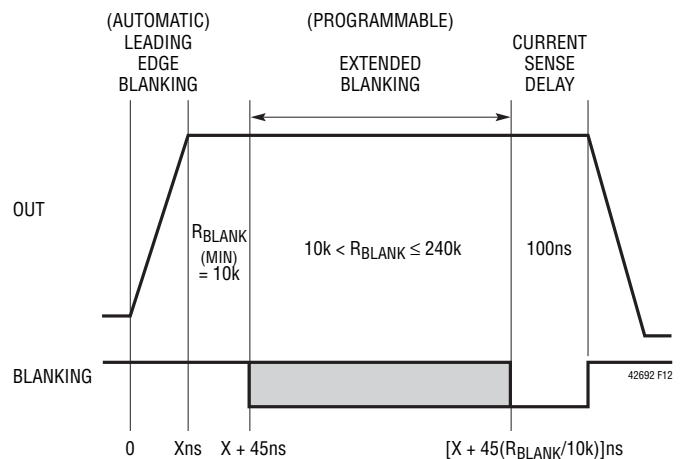

Figure 12. Leading Edge Blank Timing

## APPLICATIONS INFORMATION

where:

$R_S$  = sense resistor in source of primary MOSFET

$I_{RIPPLE}$  =  $I_{P-P}$  ripple current in the output inductor L1

$N_S$  = number of transformer secondary turns

$N_P$  = number of transformer primary turns

### Programming Slope Compensation

The LTC4269-2 uses a current mode architecture to provide fast response to load transients and to ease frequency compensation requirements. Current mode switching regulators which operate with duty cycles above 50% and have continuous inductor current must add slope compensation to their current sensing loop to prevent subharmonic oscillations. (For more information on slope compensation, see Application Note 19.) The LTC4269-2 has programmable slope compensation to allow a wide range of inductor values, to reduce susceptibility to PCB generated noise and to optimize loop bandwidth. The LTC4269-2 programs slope compensation by inserting a resistor,  $R_{SLOPE}$ , in series with the  $I_{SENSE}$  pin (Figure 13). The LTC4269-2 generates a current at the  $I_{SENSE}$  pin which is linear from 0% duty cycle to the maximum duty cycle of the OUT pin. A simple calculation of  $I_{SENSE} \cdot R_{SLOPE}$  gives an added ramp to the voltage at the  $I_{SENSE}$  pin for programmable slope compensation. (See both graphs  $I_{SENSE}$  Pin Current vs Duty Cycle and  $I_{SENSE}$  Maximum Threshold vs Duty Cycle in the Typical Performance Characteristics section.)

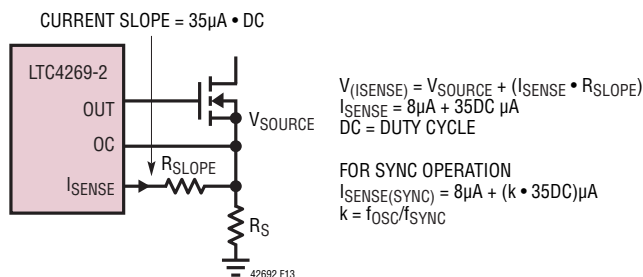

Figure 13. Programming Slope Compensation

### Programming Synchronous Rectifier Timing: SOUT to OUT delay ( $t_{DELAY}$ )

The LTC4269-2 has an additional output SOUT which provides a  $\pm 50mA$  peak drive clamped to 12V. In applications requiring synchronous rectification for high efficiency, the LTC4269-2 SOUT provides a sync signal for secondary side control of the synchronous rectifier MOSFETs (Figure 14). Timing delays through the converter can cause non-optimum control timing for the synchronous rectifier MOSFETs. The LTC4269-2 provides a programmable delay ( $t_{DELAY}$ , Figure 14) between SOUT rising edge and OUT rising edge to optimize timing control for the synchronous rectifier MOSFETs to achieve maximum efficiency gains. A resistor  $R_{DELAY}$  connected from the DELAY pin to GND sets the value of  $t_{DELAY}$ . Typical values for  $t_{DELAY}$  range from 10ns with  $R_{DELAY} = 10k$  to 160ns with  $R_{DELAY} = 160k$  (see graph in the Typical Performance Characteristics section).

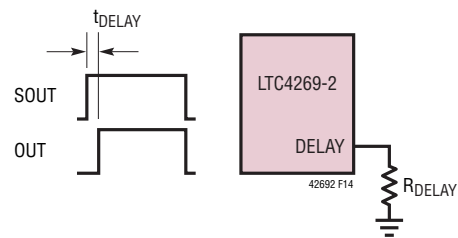

Figure 14. Programming SOUT and OUT Delay:  $t_{DELAY}$

### Programming Maximum Duty Cycle Clamp

For forward converter applications, a maximum switch duty cycle clamp which adapts to transformer input voltage is necessary for reliable control of the MOSFETs. This volt-second clamp provides a safeguard for transformer reset that prevents transformer saturation. The LTC4269-2  $SD\_V_{SEC}$  and  $SS\_MAXDC$  pins provide a capacitor-less, programmable volt-second clamp solution using simple resistor ratios (Figure 15).

An increase of voltage at the  $SD\_V_{SEC}$  pin causes the maximum duty cycle clamp to decrease. Deriving  $SD\_V_{SEC}$  from a resistor divider connected to system input voltage



## APPLICATIONS INFORMATION

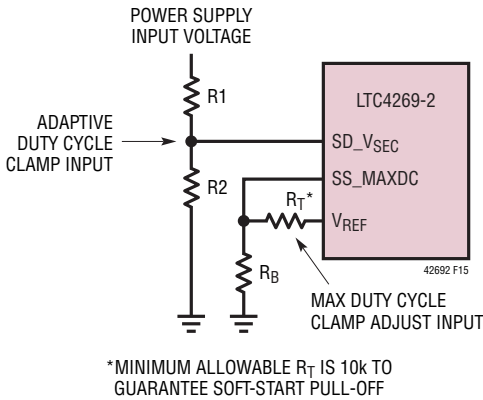

Figure 15. Programming Maximum Duty Cycle Clamp

creates the volt-second clamp. The maximum duty cycle clamp can be adjusted by programming voltage on the SS\_MAXDC pin using a resistor divider from VREF. An increase of voltage at the SS\_MAXDC pin causes the maximum duty cycle clamp to increase.

To program the volt-second clamp, the following steps should be taken:

- (1) The maximum operational duty cycle of the converter should be calculated for the given application.
- (2) An initial value for the maximum duty cycle clamp should be calculated using the equation below with a first pass guess for SS\_MAXDC.

Note: Since maximum operational duty cycle occurs at minimum system input voltage (UVLO), the voltage at the SD\_VSEC pin = 1.32V.

$$\text{Max Duty Cycle Clamp (OUT Pin)} = k \cdot 0.522(\text{SS\_MAXDC(DC)}/\text{SD\_VSEC}) - (t_{\text{DELAY}} \cdot f_{\text{OSC}})$$

where:

$$\text{SS\_MAXDC(DC)} = V_{\text{REF}}(R_B / (R_T + R_B))$$

$$\text{SD\_VSEC} = 1.32\text{V at minimum system input voltage}$$

$$t_{\text{DELAY}} = \text{programmed delay between SOUT and OUT}$$

$$k = 1.11 - 5.5e-7 \cdot (f_{\text{OSC}})$$

- (3) The maximum duty cycle clamp calculated in (2) should be programmed to be 10% greater than the maximum operational duty cycle calculated in (1). Simple adjustment of maximum duty cycle can be achieved by adjusting SS\_MAXDC.

Example calculation for (2):

For  $R_T = 35.7\text{k}$ ,  $R_B = 100\text{k}$ ,  $V_{\text{REF}} = 2.5\text{V}$ ,  $R_{\text{DELAY}} = 40\text{k}$ ,  $f_{\text{OSC}} = 200\text{kHz}$  and  $\text{SD\_VSEC} = 1.32\text{V}$ , this gives  $\text{SS\_MAXDC(DC)} = 1.84\text{V}$ ,  $t_{\text{DELAY}} = 40\text{ns}$  and  $k = 1$

Maximum Duty Cycle Clamp

$$= 1 \cdot 0.522(1.84/1.32) - (40\text{ns} \cdot 200\text{kHz})$$

$$= 0.728 - 0.008 = 0.72 \text{ (Duty Cycle Clamp} = 72\%)$$

Note 1: To achieve the same maximum duty cycle clamp at 100kHz as calculated for 200kHz, the SS\_MAXDC voltage should be reprogrammed by,

$$\text{SS\_MAXDC(DC)} (100\text{kHz})$$

$$= \text{SS\_MAXDC(DC)} (200\text{kHz}) \cdot k (200\text{kHz})/k (100\text{kHz})$$

$$= 1.84 \cdot 1.0/1.055 = 1.74\text{V} (k = 1.055 \text{ for } 100\text{kHz})$$

Note 2: To achieve the same maximum duty cycle clamp while synchronizing to an external clock at the SYNC pin, the SS\_MAXDC voltage should be reprogrammed as,

$$\text{SS\_MAXDC (DC)} (f_{\text{sync}})$$

$$= \text{SS\_MAXDC (DC)} (200\text{kHz}) \cdot [(f_{\text{osc}}/f_{\text{sync}}) + 0.09(f_{\text{osc}}/200\text{kHz})0.6]$$

For  $\text{SS\_MAXDC (DC)} (200\text{kHz}) = 1.84\text{V}$  for 72% duty cycle

$$\text{SS\_MAXDC (DC)} (f_{\text{sync}} = 250\text{kHz}) \text{ for } 72\% \text{ duty cycle}$$

$$= 1.84 \cdot [(200\text{kHz}/250\text{kHz}) + 0.09(1)0.6]$$

$$= 1.638\text{V}$$

### Programming Soft-Start Timing

The LTC4269-2 has built-in soft-start capability to provide low stress controlled start-up from a list of fault conditions that can occur in the application (see Figures 16 and 17). The LTC4269-2 provides true PWM soft-start by

## APPLICATIONS INFORMATION

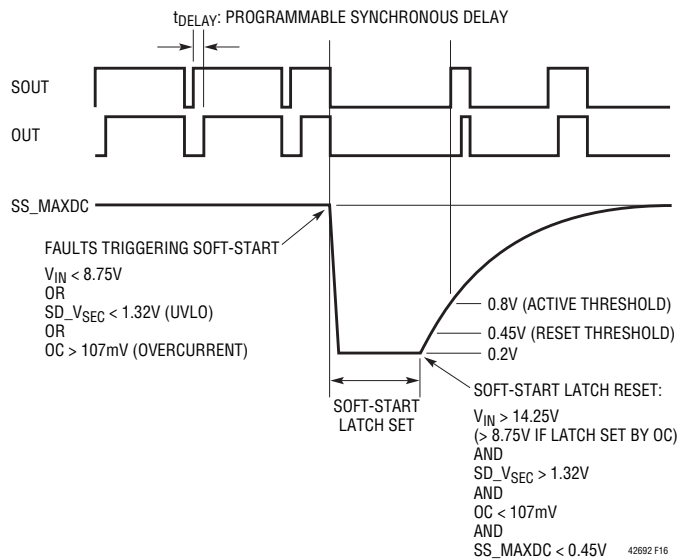

Figure 16. Timing Diagram

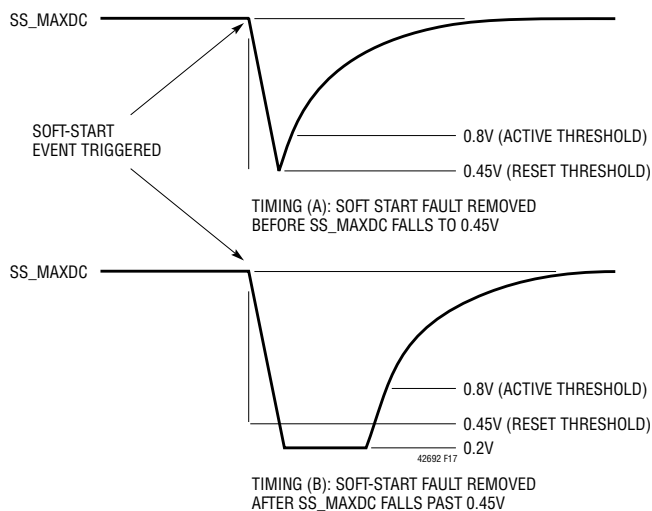

Figure 17. Soft-Start Timing

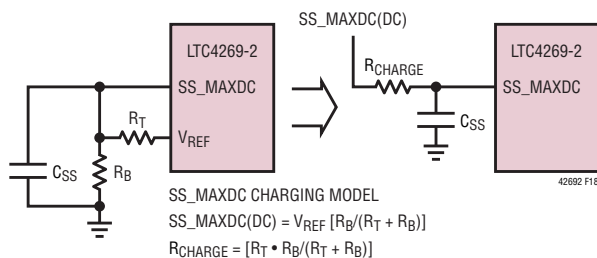

Figure 18. Programming Soft-Start Timing

using the SS\_MAXDC pin to control soft-start timing. The proportional relationship between SS\_MAXDC voltage and switch maximum duty cycle clamp allows the SS\_MAXDC pin to slowly ramp output voltage by ramping the maximum switch duty cycle clamp—until switch duty cycle clamp seamlessly meets the natural duty cycle of the converter. A capacitor  $C_{\text{SS}}$  on the SS\_MAXDC pin and the resistor divider from  $V_{\text{REF}}$  used to program maximum switch duty cycle clamp, determine soft-start timing (Figure 18).

A soft-start event is triggered for the following faults:

- (1)  $V_{\text{IN}} < 8.75\text{V}$ , or
- (2)  $\text{SD\_V}_{\text{SEC}} < 1.32\text{V}$  (UVLO), or
- (3)  $\text{OC} > 107\text{mV}$  (overcurrent condition)

When a soft-start event is triggered, switching at SOUT and OUT is stopped immediately. A soft-start latch is set and SS\_MAXDC pin is discharged. The SS\_MAXDC pin can only recharge when the soft-start latch has been reset.

Note: A soft-start event caused by (1) or (2) above, also causes  $V_{\text{REF}}$  to be disabled and to fall to GND.

Soft-start latch reset requires all of the following:

- (A)  $V_{\text{IN}} > 14.25\text{V}^*$ , and
- (B)  $\text{SD\_V}_{\text{SEC}} > 1.32\text{V}$ , and
- (C)  $\text{OC} < 107\text{mV}$ , and
- (D)  $\text{SS\_MAXDC} < 0.45\text{V}$  (SS\_MAXDC reset threshold)

\* $V_{\text{IN}} > 8.75\text{V}$  is okay for latch reset if the latch was only set by overcurrent condition in (3) above.

### SS\_MAXDC Discharge Timing

It can be seen in Figure 17 that two types of discharge can occur for the SS\_MAXDC pin. In timing (A) the fault that caused the soft-start event has been removed before SS\_MAXDC falls to 0.45V. This means the soft-start latch will be reset when SS\_MAXDC falls to 0.45V and SS\_MAXDC will begin charging. In timing (B), the fault that caused the soft-start event is not removed until some time after SS\_MAXDC has fallen past 0.45V. The SS\_MAXDC pin continues to discharge to 0.2V and remains low until all faults are removed.

## APPLICATIONS INFORMATION

The time for SS\_MAXDC to fall to a given voltage can be approximated as:

$$SS\_MAXDC(t_{FALL}) = (C_{SS}/I_{DIS}) \cdot [SS\_MAXDC(DC) - V_{SS(MIN)}]$$

where:

$I_{DIS}$  = net discharge current on  $C_{SS}$

$C_{SS}$  = capacitor value at SS\_MAXDC pin

SS\_MAXDC(DC) = programmed DC voltage

$V_{SS(MIN)}$  = minimum SS\_MAXDC voltage before recharge

$$I_{DIS} \cong 8e^{-4} + (V_{REF} - V_{SS(MIN)})[(1/2R_B) - (1/R_T)]$$

For faults arising from (1) and (2):

$$V_{REF} = 100mV.$$

For a fault arising from (3):

$$V_{REF} = 2.5V.$$

$$SS\_MAXDC(DC) = V_{REF}[R_B/(R_T + R_B)]$$

$V_{SS(MIN)}$  = SS\_MAXDC reset threshold = 0.45V  
(if fault removed before  $t_{FALL}$ )

Example

For an overcurrent fault ( $OC > 100mV$ ),  $V_{REF} = 2.5V$ ,  
 $R_T = 35.7k$ ,  $R_B = 100k$ ,  $C_{SS} = 0.1\mu F$  and assume  
 $V_{SS(MIN)} = 0.45V$ ,  
 $I_{DIS} \cong 8e^{-4} + (2.5 - 0.45)[(1/2 \cdot 100k) - (1/35.7k)]$   
 $= 8e^{-4} + (2.05)(-0.23e^{-4}) = 7.5e^{-4}$

$$SS\_MAXDC(DC) = 1.84V$$

$$SS\_MAXDC(t_{FALL}) = (1e^{-7}/7.5e^{-4}) \cdot (1.84 - 0.45) = 1.85e^{-4}s$$

If the OC fault is not removed before  $185\mu s$  then SS\_MAXDC will continue to fall past 0.45V towards a new  $V_{SS(MIN)}$ . The typical  $V_{OL}$  for SS\_MAXDC at  $150\mu A$  is 0.2V.

### SS\_MAXDC Charge Timing

When all faults are removed and the SS\_MAXDC pin has fallen to its reset threshold of 0.45V or lower, the SS\_MAXDC pin will be released and allowed to charge.

SS\_MAXDC will rise until it settles at its programmed DC voltage—setting the maximum switch duty cycle clamp.

The calculation of charging time for the SS\_MAXDC pin between any two voltage levels can be approximated as an RC charging waveform using the model shown in Figure 16.

The ability to predict SS\_MAXDC rise time between any two voltages allows prediction of several key timing periods:

- (1) No Switching Period (time from SS\_MAXDC(DC) to  $V_{SS(MIN)}$  + time from  $V_{SS(MIN)}$  to  $V_{SS(ACTIVE)}$ )
- (2) Converter Output Rise Time (time from  $V_{SS(ACTIVE)}$  to  $V_{SS(REG)}$ ;  $V_{SS(REG)}$  is the level of SS\_MAXDC where maximum duty cycle clamp equals the natural duty cycle of the switch)
- (3) Time For Maximum Duty Cycle Clamp within X% of Target Value

The time for SS\_MAXDC to charge to a given voltage  $V_{SS}$  is found by re-arranging:

$$V_{SS}(t) = SS\_MAXDC(DC) (1 - e^{(-t/RC)})$$

to give,

$$t = RC \cdot (-1) \cdot \ln(1 - V_{SS}/SS\_MAXDC(DC))$$

where,

$V_{SS}$  = SS\_MAXDC voltage at time t

SS\_MAXDC(DC) = programmed DC voltage setting  
maximum duty cycle clamp =  $V_{REF}(R_B/(R_T + R_B))$

$R = R_{CHARGE}$  (Figure 16) =  $R_T \cdot R_B/(R_T + R_B)$

$C = C_{SS}$  (Figure 16)

### Example (1) No Switching Period

The period of no switching for the converter, when a soft-start event has occurred, depends on how far SS\_MAXDC can fall before recharging occurs and how long a fault exists. It will be assumed that a fault triggering soft-start is removed before SS\_MAXDC can reach its reset threshold (0.45V).

$$\text{No Switching Period} = t_{DISCHARGE} + t_{CHARGE}$$

$t_{DISCHARGE}$  = discharge time from SS\_MAXDC(DC) to 0.45V

$t_{CHARGE}$  = charge time from 0.45V to  $V_{SS(ACTIVE)}$

$t_{DISCHARGE}$  was already calculated earlier as  $185\mu s$ .

## APPLICATIONS INFORMATION

$t_{\text{CHARGE}}$  is calculated by assuming the following:

$$V_{\text{REF}} = 2.5\text{V}, R_{\text{T}} = 35.7\text{k}, R_{\text{B}} = 100\text{k}, C_{\text{SS}} = 0.1\mu\text{F} \text{ and } V_{\text{SS(MIN)}} = 0.45\text{V}.$$

$$t_{\text{CHARGE}} = t(V_{\text{SS}} = 0.8\text{V}) - t(V_{\text{SS}} = 0.45\text{V})$$

Step 1:

$$\text{SS\_MAXDC(DC)} = 2.5[100\text{k}/(35.7\text{k} + 100\text{k})] = 1.84\text{V}$$

$$R_{\text{CHARGE}} = (35.7\text{k} \cdot 100\text{k}/135.7\text{k}) = 26.3\text{k}$$

Step 2:

$t(V_{\text{SS}} = 0.45\text{V})$  is calculated from:

$$\begin{aligned} t &= R_{\text{CHARGE}} \cdot C_{\text{SS}} \cdot (-1) \cdot \ln(1 - V_{\text{SS}}/\text{SS\_MAXDC(DC)}) \\ &= 2.63\text{e}^4 \cdot 1\text{e}^{-7} \cdot (-1) \cdot \ln(1 - 0.45/1.84) \\ &= 2.63\text{e}^{-3} \cdot (-1) \cdot \ln(0.755) = 7.3\text{e}^{-4} \text{ s} \end{aligned}$$

Step 3:

$t(V_{\text{SS}} = 0.8\text{V})$  is calculated from:

$$\begin{aligned} t &= R_{\text{CHARGE}} \cdot C_{\text{SS}} \cdot (-1) \cdot \ln(1 - V_{\text{SS}}/\text{SS\_MAXDC(DC)}) \\ &= 2.63\text{e}^4 \cdot 1\text{e}^{-7} \cdot (-1) \cdot \ln(1 - 0.8/1.84) \\ &= 2.63\text{e}^{-3} \cdot (-1) \cdot \ln(0.565) = 1.5\text{e}^{-3} \text{ s} \end{aligned}$$

From Step 1 and Step 2

$$t_{\text{CHARGE}} = (1.5 - 0.73)\text{e}^{-3} \text{ s} = 7.7\text{e}^{-4} \text{ s}$$

The total time of no switching for the converter due to a soft-start event

$$= t_{\text{DISCHARGE}} + t_{\text{CHARGE}} = 1.85\text{e}^{-4} + 7.7\text{e}^{-4} = 9.55\text{e}^{-4} \text{ s}$$

### Example (2) Converter Output Rise Time

The rise time for the converter output to reach regulation can be closely approximated as the time between the start of switching ( $\text{SS\_MAXDC} = V_{\text{SS(ACTIVE)}}$ ) and the time where converter duty cycle is in regulation ( $\text{DC(REG)}$ ) and no longer controlled by  $\text{SS\_MAXDC}$  ( $\text{SS\_MAXDC} = V_{\text{SS(REG)}}$ ). Converter output rise time can be expressed as:

$$\text{Output Rise Time} = t(V_{\text{SS(REG)}}) - t(V_{\text{SS(ACTIVE)}})$$

Step 1: Determine converter duty cycle  $\text{DC(REG)}$  for output in regulation.

The natural duty cycle  $\text{DC(REG)}$  of the converter depends on several factors. For this example it is assumed that  $\text{DC(REG)} = 60\%$  for power supply input voltage near the power supply UVLO. This gives  $\text{SD\_VSEC} = 1.32\text{V}$ .

Also assume that the maximum duty cycle clamp programmed for this condition is 72% for  $\text{SS\_MAXDC(DC)} = 1.84\text{V}$ ,  $f_{\text{OSC}} = 200\text{kHz}$  and  $R_{\text{DELAY}} = 40\text{k}$ .

Step 2: Calculate  $V_{\text{SS(REG)}}$

To calculate the level of  $\text{SS\_MAXDC}$  ( $V_{\text{SS(REG)}}$ ) that no longer clamps the natural duty cycle of the converter, the equation for maximum duty cycle clamp must be used (see previous section Programming Maximum Duty Cycle Clamp).

The point where the maximum duty cycle clamp meets  $\text{DC(REG)}$  during soft-start is given by:

$$\text{DC(REG)} = \text{Max Duty Cycle Clamp}$$

$$0.6 = k \cdot 0.522(\text{SS\_MAXDC(DC)}/\text{SD\_VSEC}) - (t_{\text{DELAY}} \cdot f_{\text{OSC}})$$

$$\text{For } \text{SD\_VSEC} = 1.32\text{V}, f_{\text{OSC}} = 200\text{kHz} \text{ and } R_{\text{DELAY}} = 40\text{k}$$

This gives  $k = 1$  and  $t_{\text{DELAY}} = 40\text{ns}$ .

Rearranging the above equation to solve for  $\text{SS\_MAXDC} = V_{\text{SS(REG)}}$

$$\begin{aligned} &= [0.6 + (t_{\text{DELAY}} \cdot f_{\text{OSC}})(\text{SD\_VSEC})]/(k \cdot 0.522) \\ &= [0.6 + (40\text{ns} \cdot 200\text{kHz})(1.32\text{V})]/(1 \cdot 0.522) \\ &= (0.608)(1.32)/0.522 = 1.537\text{V} \end{aligned}$$

Step 3: Calculate  $t(V_{\text{SS(REG)}}) - t(V_{\text{SS(ACTIVE)}})$

Recall the time for  $\text{SS\_MAXDC}$  to charge to a given voltage  $V_{\text{SS}}$  is given by:

$$t = R_{\text{CHARGE}} \cdot C_{\text{SS}} \cdot (-1) \cdot \ln(1 - V_{\text{SS}}/\text{SS\_MAXDC(DC)})$$

(Figure 16 gives the model for  $\text{SS\_MAXDC}$  charging)

For  $R_{\text{T}} = 35.7\text{k}$ ,  $R_{\text{B}} = 100\text{k}$ ,  $R_{\text{CHARGE}} = 26.3\text{k}$

$$\begin{aligned} \text{For } C_{\text{SS}} = 0.1\mu\text{F}, \text{ this gives } t(V_{\text{SS(ACTIVE)}}) \\ &= t(V_{\text{SS}(0.8\text{V})}) = 2.63\text{e}^4 \cdot 1\text{e}^{-7} \cdot (-1) \cdot \ln(1 - 0.8/1.84) \\ &= 2.63\text{e}^{-3} \cdot (-1) \cdot \ln(0.565) = 1.5\text{e}^{-3} \text{ s} \end{aligned}$$

$$\begin{aligned} t(V_{\text{SS(REG)}}) &= t(V_{\text{SS}(1.537\text{V})}) = 26.3\text{k} \cdot 0.1\mu\text{F} \cdot (-1) \cdot \\ &\ln(1 - 1.66/1.84) = 2.63\text{e}^{-3} \cdot (-1) \cdot \ln(0.146) = 5\text{e}^{-3} \text{ s} \end{aligned}$$

The rise time for the converter output:

$$\begin{aligned} &= t(V_{\text{SS(REG)}}) - t(V_{\text{SS(ACTIVE)}}) = (5 - 1.5)\text{e}^{-3} \text{ s} \\ &= 3.5\text{e}^{-3} \text{ s} \end{aligned}$$

## APPLICATIONS INFORMATION

### Example (3) Time For Maximum Duty Cycle Clamp to Reach Within X% of Target Value

A maximum duty cycle clamp of 72% was calculated previously in the section 'Programming Maximum Duty Cycle Clamp'. The programmed value used for SS\_MAXDC(DC) was 1.84V.

The time for SS\_MAXDC to charge from its minimum value  $V_{SS(MIN)}$  to within X% of SS\_MAXDC(DC) is given by:

$$\begin{aligned} & t(\text{SS\_MAXDC charge time within X\% of target}) \\ & = t[(1 - (X/100) \cdot \text{SS\_MAXDC(DC)}) - t(V_{SS(MIN)})] \end{aligned}$$

$$\begin{aligned} \text{For } X = 2 \text{ and } V_{SS(MIN)} = 0.45\text{V, } & t(0.98 \cdot 1.84) - t(0.45) \\ & = t(1.803) - t(0.45) \end{aligned}$$

From previous calculations,  $t(0.45) = 7.3e^{-4}\text{s}$ .

Using previous values for  $R_T$ ,  $R_B$  and  $C_{SS}$ ,

$$\begin{aligned} t(1.803) & = 2.63e^{-4} \cdot 1e^{-7} \cdot (-1) \cdot \ln(1 - 1.803/1.84) \\ & = 2.63e^{-3} \cdot (-1) \cdot \ln(0.02) = 1.03e^{-2} \text{ s} \end{aligned}$$

Hence the time for SS\_MAXDC to charge from its minimum reset threshold of 0.45V to within 2% of its target value is given by:

$$t(1.803) - t(0.45) = 1.03e^{-2} - 7.3e^{-4} = 9.57e^{-3}\text{s}$$



# PACKAGE DESCRIPTION

**DKD Package**  
**32-Lead Plastic DFN (7mm × 4mm)**  
 (Reference LTC DWG # 05-08-1734 Rev A)

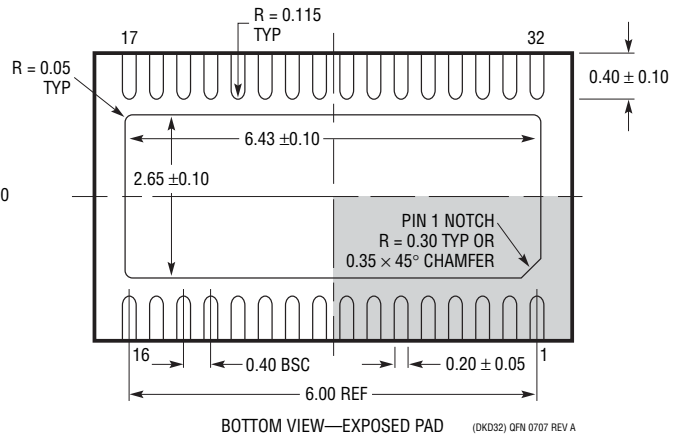
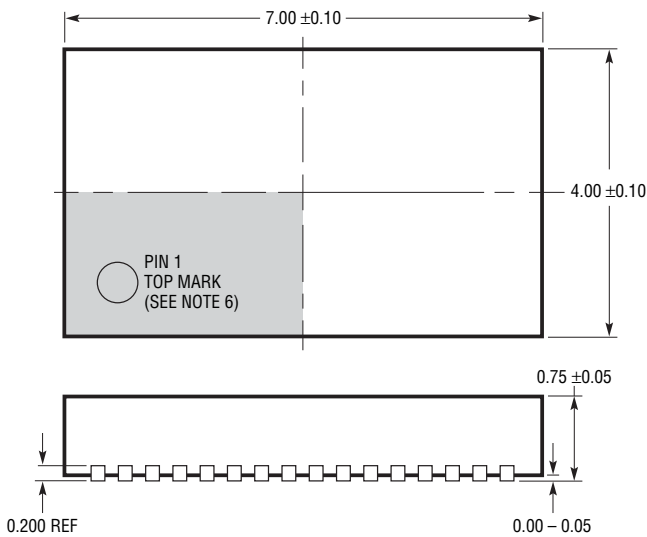
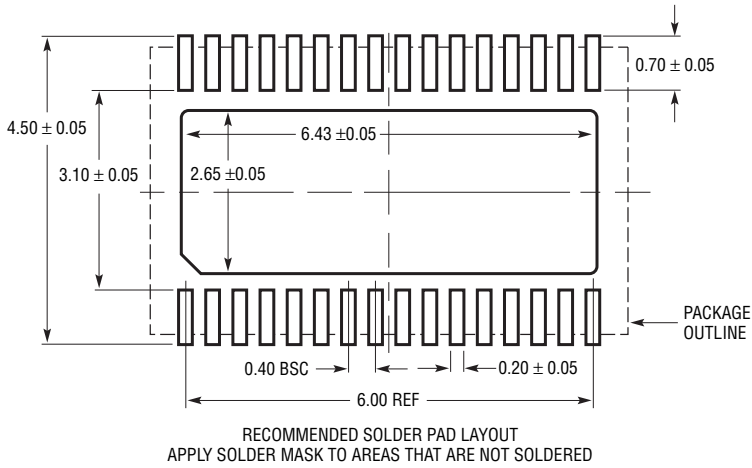

- NOTE:
1. DRAWING PROPOSED TO BE MADE VARIATION OF VERSION (WXXX) IN JEDEC PACKAGE OUTLINE MO-229
  2. DRAWING NOT TO SCALE
  3. ALL DIMENSIONS ARE IN MILLIMETERS
  4. DIMENSIONS OF EXPOSED PAD ON BOTTOM OF PACKAGE DO NOT INCLUDE MOLD FLASH. MOLD FLASH, IF PRESENT, SHALL NOT EXCEED 0.20mm ON ANY SIDE
  5. EXPOSED PAD SHALL BE SOLDER PLATED
  6. SHADED AREA IS ONLY A REFERENCE FOR PIN 1 LOCATION ON THE TOP AND BOTTOM OF PACKAGE

**REVISION HISTORY** (Revision history begins at Rev B)

REV	DATE	DESCRIPTION	PAGE NUMBER
B	04/10	Connected PWRGD Pin to SD_V <sub>SEC</sub> Pin in Typical Applications Circuits. Added Text Clarifying Connecting PWRGD Pin to SD_V <sub>SEC</sub> Pin in Shutdown and Programming the Power Supply Undervoltage Lockout Section of Applications Information.	1, 23, 31 23



**RELATED PARTS**

PART NUMBER	DESCRIPTION	COMMENTS
LT®1952	Single Switch Synchronous Forward Controller	Synchronous Controller, Programmable Volt-Sec Clamp, Low Start Current
LTC3803	Current Mode Flyback DC/DC Controller in ThinSOT™	200kHz Constant Frequency, Adjustable Slope Compensation, Optimized for High Input Voltage Applications
LTC3805	Adjustable Frequency Current Mode Flyback Controller	Slope Comp Overcurrent Protect, Internal/External Clock
LTC3825	Isolate No-Opto Synchronous Flyback Controller with Wide Input Supply Range	Adjustable Switching Frequency, Programmable Undervoltage Lockout, Accurate Regulation Without Trim, Synchronous for High Efficiency.
LTC4257-1	IEEE 802.3af PD Interface Controller	100V 400mA Internal Switch, Programmable Classification Dual Current Limit
LTC4258	Quad IEEE 802.3af Power over Ethernet Controller	DC Disconnect Only, IEEE-Compliant PD Detection and Classification, Autonomous Operation or I <sup>2</sup> C Control
LTC4259A-1	Quad IEEE 802.3af Power over Ethernet Controller	AC or DC Disconnect IEEE-Compliant PD Detection and Classification, Autonomous Operation or I <sup>2</sup> C Control
LTC4263	Single IEEE 802.3af Power over Ethernet Controller	AC or DC Disconnect IEEE-Compliant PD Detection and Classification, Autonomous Operation
LTC4263-1	High Power Single PSE Controller	Internal Switch, Autonomous Operation, 30W
LTC4265	IEEE 802.3at PD Interface Controller	2-Event Classification Signaling, Programmable Classification, Auxiliary Support
LTC4266	Quad IEEE 802.3at PSE Controller	Type 1 and 2 Compliant, 180mW/Port at 720mA, Advanced Power Management, 4-Point PD Detection
LTC4267-1/ LTC4267-3	IEEE 802.3af PD Interface with Integrated Switching Regulator	100V 400mA Internal Switch, Programmable Classification, 200KHz or 300kHz Constant Frequency PWM, Interface and Switcher Optimized for IEEE-Compliant PD System.
LTC4268-1	35W High Power PD Interface with Integrated Switching Regulator	750mA MOSFET, Programmable Classification, Synchronous No-Opto Flyback Controller, 50kHz to 250kHz
LTC4269-1	IEEE 802.3at PD Interface Integrated Switching Regulator	2-Event Classification, Programmable Classification, Synchronous No-Opto Flyback Controller, 50kHz to 250kHz

# Mouser Electronics

Authorized Distributor

Click to View Pricing, Inventory, Delivery & Lifecycle Information:

[Analog Devices Inc.:](#)

[LTC4269CDKD-2#PBF](#) [LTC4269IDKD-2#PBF](#) [LTC4269IDKD-2#TRPBF](#) [LTC4269CDKD-2#TRPBF](#)