

High-Speed, 6A Single MOSFET Drivers

ABSOLUTE MAXIMUM RATINGS

| | | | |
|--|-----------------------------|-------------------------------------|-----------------|
| Supply Voltage V_{DD} to GND | +20V | Operating Temperature Ranges: | |
| Input Voltage V_{IN} | -0.3V to (V_{DD} + 0.3V) | MAX442_C__, MXT429C__ | 0°C to +70°C |
| Continuous Power Dissipation ($T_A = +70^\circ\text{C}$) | | MAX442_E__, MXT429E__ | -40°C to +85°C |
| Plastic DIP (derate 9.09mW/°C above +70°C) | 727mW | MAX442_MJA, MXT429MJA | -55°C to +125°C |
| SO (derate 5.88mW/°C above +70°C) | 471mW | Storage Temperature Range | -65°C to +160°C |
| CERDIP (derate 8.00mW/°C above +70°C) | 640mW | Lead Temperature (soldering, 10sec) | +300°C |

Stresses beyond those listed under "Absolute Maximum Ratings" may cause permanent damage to the device. These are stress ratings only, and functional operation of the device at these or any other conditions beyond those indicated in the operational sections of the specifications is not implied. Exposure to absolute maximum rating conditions for extended periods may affect device reliability.

ELECTRICAL CHARACTERISTICS

(MAX4420/MAX4429 $V_{DD} = +4.5\text{V}$ to +18V, MXT429 $V_{DD} = +7\text{V}$ to +18V, $T_A = T_{MIN}$ to T_{MAX} , unless otherwise noted.)

| PARAMETER | SYMBOL | CONDITIONS | | MAX4420/MAX4429 | | | MXT429 | | | UNITS |
|-----------------------|-----------|---|------------------------------|-----------------|-------|----------|---------------|----------|---------------|----------|
| | | | | MIN | TYP | MAX | MIN | TYP | MAX | |
| Operating Range | V_{DD} | | | 4.5 | | 18 | 7 | | 18 | V |
| Power Supply Current | I_{DD} | $V_{IN} = 3\text{V}$ | $T_A = +25^\circ\text{C}$ | 0.45 | 1.5 | | 0.45 | 5.0 | | mA |
| | | | $T_A = T_{MIN}$ to T_{MAX} | | | 3.0 | | 12.0 | | |
| | | $V_{IN} = 0\text{V}$ | $T_A = +25^\circ\text{C}$ | 0.045 | 0.150 | | 0.045 | 0.5 | | |
| | | | $T_A = T_{MIN}$ to T_{MAX} | | | 0.400 | | 1.0 | | |
| Logic 1 Input Voltage | V_{IH} | | | 2.4 | | | 2.4 | | V | |
| Logic 0 Input Voltage | V_{IL} | | | | | 0.8 | | 0.8 | V | |
| IN Leakage Current | I_{IN} | $V_{IN} = 0\text{V}$ to V_{DD} | | | | ± 10 | | ± 10 | μA | |
| Output High Voltage | V_{OH} | No load | | $V_{DD} - 25$ | | | $V_{DD} - 25$ | | | mV |
| Output Low Voltage | V_{OL} | No load | | 25 | | | 25 | | | mV |
| Peak Output Current | I_{OUT} | $V_{DD} = 18\text{V}$ | $T_A = +25^\circ\text{C}$ | 6 | | 6 | | 6 | | A |
| Output Resistance | R_{OUT} | $V_{DD} = 18\text{V}$, $I_{OUT} = 10\text{mA}$, $V_{IN} = 0.8\text{V}$ or 2.4V | $T_A = +25^\circ\text{C}$ | 1.5 | 2.5 | | 1.5 | 2.5 | | Ω |
| | | | $T_A = T_{MIN}$ to T_{MAX} | | | 5.0 | | 5.0 | | |
| Rise Time (Note 1) | t_R | Figure 1 | $T_A = +25^\circ\text{C}$ | 25 | 30 | | 25 | 35 | | ns |
| | | | $T_A = T_{MIN}$ to T_{MAX} | | | 60 | | 70 | | |
| Fall Time (Note 1) | t_F | Figure 1 | $T_A = +25^\circ\text{C}$ | 25 | 30 | | 25 | 35 | | ns |
| | | | $T_A = T_{MIN}$ to T_{MAX} | | | 60 | | 70 | | |
| Delay Time (Note 1) | t_{D1} | Figure 1 | $T_A = +25^\circ\text{C}$ | 35 | 60 | | 35 | 75 | | ns |
| | | | $T_A = T_{MIN}$ to T_{MAX} | | | 100 | | 100 | | |
| | t_{D2} | Figure 1 | $T_A = +25^\circ\text{C}$ | 40 | 60 | | 40 | 75 | | |
| | | | $T_A = T_{MIN}$ to T_{MAX} | | | 100 | | 120 | | |

Note 1: Switching times guaranteed by design, not tested. See Figure 1 for timing measurement circuit, $V_{DD} = 18\text{V}$.

High-Speed, 6A Single MOSFET Drivers

Typical Operating Characteristics

MAX4420/MAX4429/MXT429

MAX4429 SWITCHING SPEED (INPUT HIGH TO LOW)

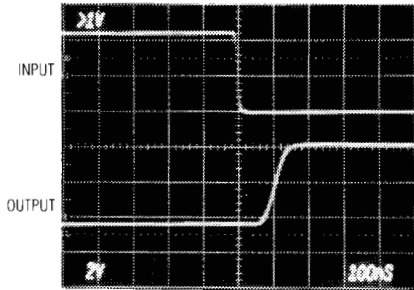

$V_{DD} = 4.5V$, $C_L = 2500pF$, TIME = 100ns/div,
 $V_{IN} = 5V$ TO $0V$,
 $T_A = +25^\circ C$

MAX4429 SWITCHING SPEED (INPUT LOW TO HIGH)

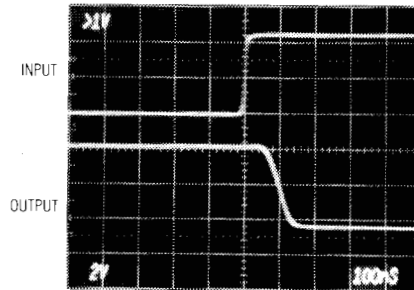

$V_{DD} = 4.5V$, $C_L = 2500pF$, TIME = 100ns/div,
 $V_{IN} = 0V$ TO $5V$,
 $T_A = +25^\circ C$

MAX4429 SWITCHING SPEED (INPUT HIGH TO LOW)

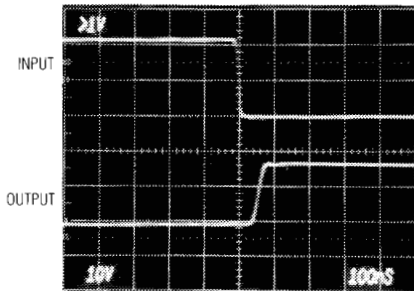

$V_{DD} = 18V$, $C_L = 2500pF$, TIME = 100ns/div,
 $V_{IN} = 5V$ TO $0V$,
 $T_A = +25^\circ C$

MAX4429 SWITCHING SPEED (INPUT LOW TO HIGH)

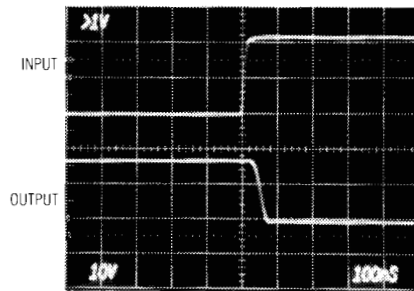

$V_{DD} = 18V$, $C_L = 2500pF$, TIME = 100ns/div,
 $V_{IN} = 0V$ TO $5V$,
 $T_A = +25^\circ C$

FALL TIME vs. POSITIVE SUPPLY VOLTAGE

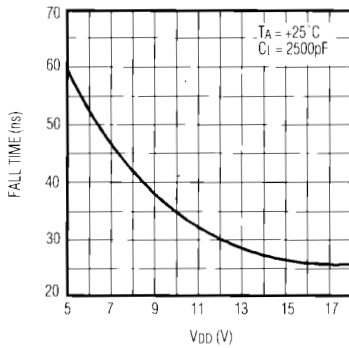

RISE TIME vs. POSITIVE SUPPLY VOLTAGE

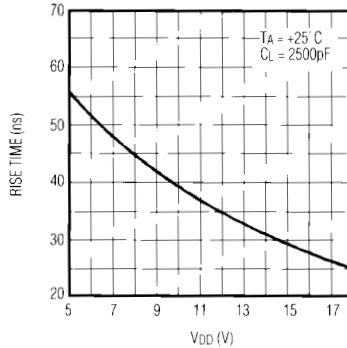

RISE AND FALL TIMES vs. TEMPERATURE

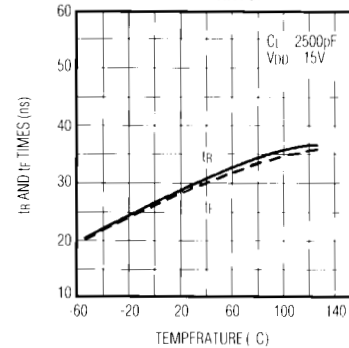

High-Speed, 6A Single MOSFET Drivers

Typical Operating Characteristics (continued)

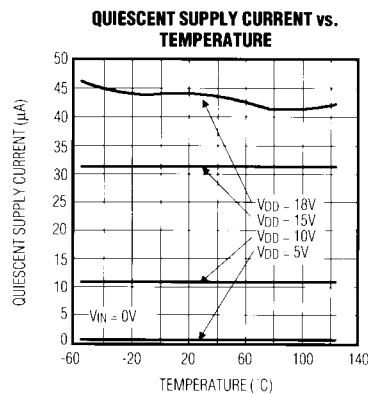
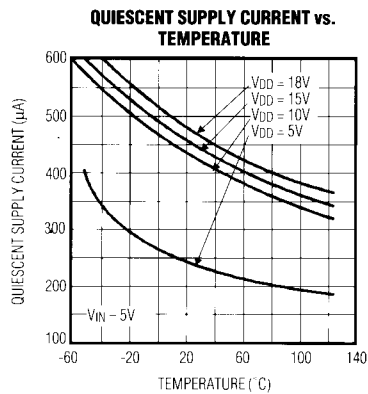
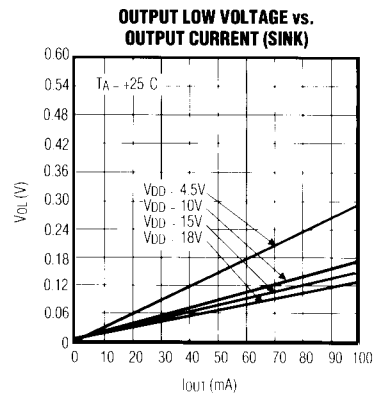
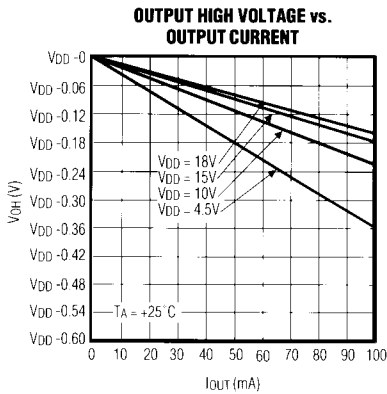
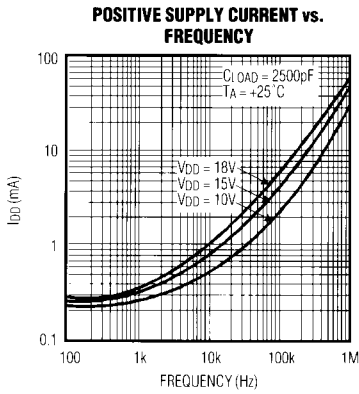
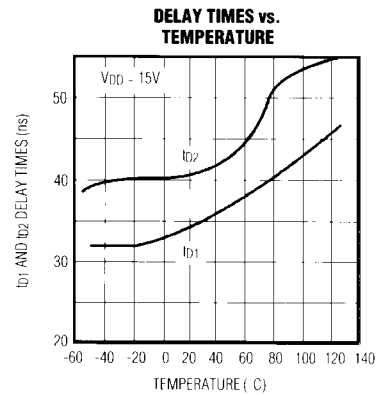
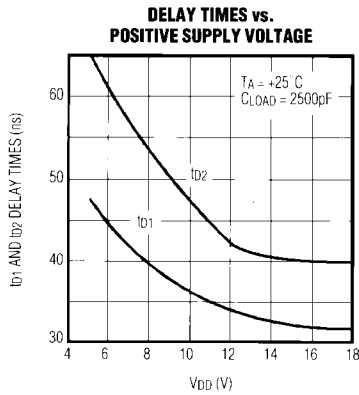
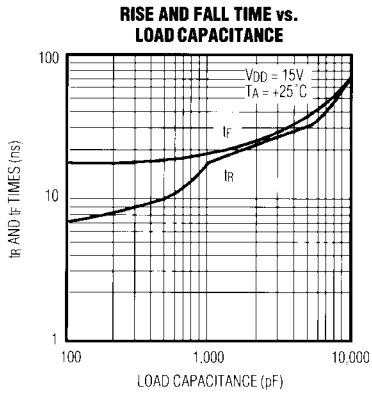

High-Speed, 6A Single MOSFET Drivers

MAX4420/MAX4429/MXT429

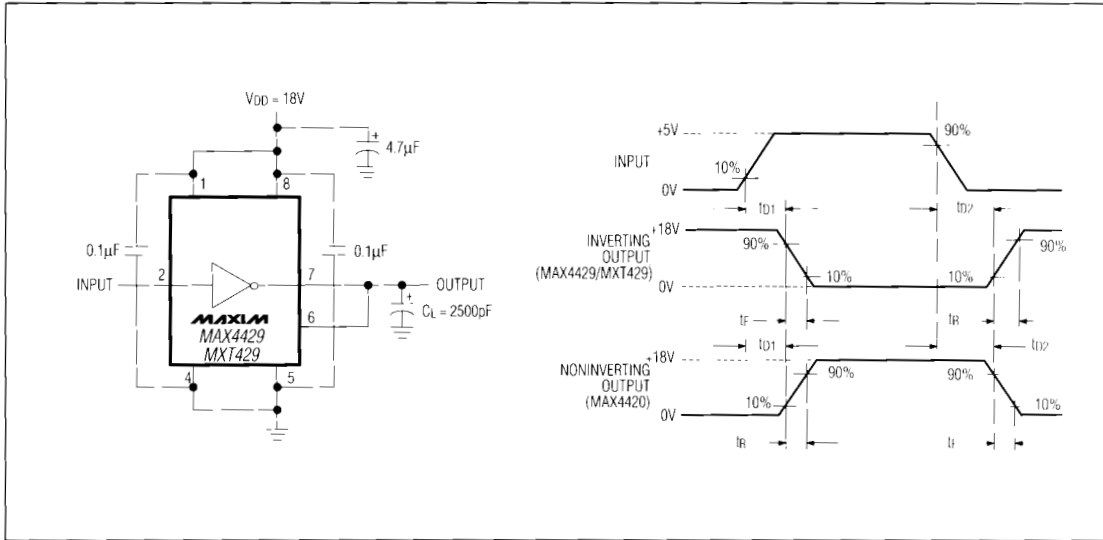

Figure 1. Switching-Time Measurement Circuit

Applications Information

The MAX4420/MAX4429/MXT429 have easy-to-drive inputs. However, the input must not be allowed to stay between V_{IH} and V_{IL} for more than 500ns. The power supply (V_{DD}) inputs must always be tied together, as should the outputs (OUT).

Supply bypassing and grounding are extremely important, as the peak supply and output currents can be greater than 6A. Ground drops are a form of negative feedback with inverters, and therefore will degrade the delay and transition time. Ringing may also be a problem with large $\Delta V/\Delta t$ and/or large AC currents.

Suggested bypass capacitors are a 4.7µF (low ESR) capacitor in parallel with 0.1µF ceramic capacitors, mounted as close as possible to the device. Use a ground plane if possible, or separate ground returns for inputs and outputs. Ringing can be minimized with a 5Ω resistor in series with the output, but this will degrade output transition time.

Power Dissipation

Power dissipation of the MAX4420/MAX4429/MXT429 consists of:

- 1) input inverter losses
- 2) crowbar current through the output devices
- 3) output current (either capacitive or resistive).

The sum of these must be kept below the maximum power-dissipation limit.

The DC input inverter losses are typically 45µA when the input is low and 450µA when the input is high.

The crowbar current through an output device making a transition is approximately 100mA for a few nanoseconds. This is a small portion of the total supply current, except for high switching frequencies or a small load capacitance (100pF).

The MAX4420/MAX4429/MXT429 power dissipation when driving a ground referenced resistive load is:

$$P = D \times R_{ON(max)} \times I_{LOAD}^2$$

where D is the percentage of time the MAX4420/MAX4429/MXT429 output pulls high, $R_{ON(max)}$ is the maximum on resistance of the device with the output high, and I_{LOAD} is the load current of the MAX4420/MAX4429/MXT429.

For capacitive loads, the power dissipation is:

$$P = C_{LOAD} \times V_{DD}^2 \times \text{FREQ}$$

where C_{LOAD} is the capacitive load, V_{DD} is the MAX4420/MAX4429/MXT429 supply voltage, and FREQ is the toggle frequency.

High-Speed, 6A Single MOSFET Drivers

Ordering Information (continued)

| PART | TEMP. RANGE | PIN-PACKAGE |
|-----------|-----------------|---------------|
| MXT429CPA | 0°C to +70°C | 8 Plastic DIP |
| MXT429CSA | 0°C to +70°C | 8 SO |
| MXT429C/D | 0°C to +70°C | Dice* |
| MXT429EPA | -40°C to +85°C | 8 Plastic DIP |
| MXT429ESA | -40°C to +85°C | 8 SO |
| MXT429MJA | -55°C to +125°C | 8 CERDIP** |

* Dice are specified at $T_A = +25^\circ\text{C}$.

** Contact factory for availability and processing to MIL-STD-883 and DESC-SMD.

Chip Topography

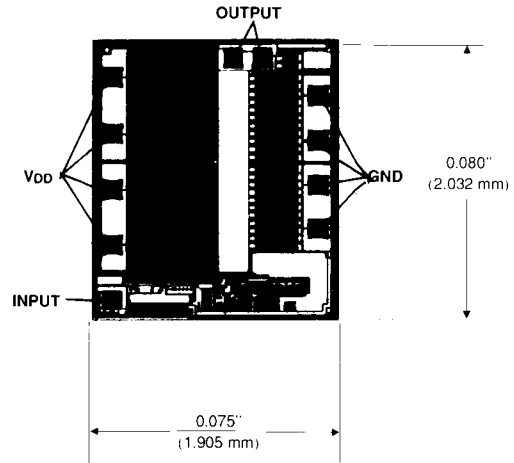

TRANSISTOR COUNT: 16;
SUBSTRATE CONNECTED TO V_{DD} .

Maxim cannot assume responsibility for use of any circuitry other than circuitry entirely embodied in a Maxim product. No circuit patent licenses are implied. Maxim reserves the right to change the circuitry and specifications without notice at any time.

6 Maxim Integrated Products, 120 San Gabriel Drive, Sunnyvale, CA 94086 (408) 737-7600

© 1992 Maxim Integrated Products

Printed USA

MAXIM is a registered trademark of Maxim Integrated Products.

Mouser Electronics

Authorized Distributor

Click to View Pricing, Inventory, Delivery & Lifecycle Information:

Maxim Integrated:

[MAX4420CPA+](#) [MAX4420CSA+](#) [MAX4420ESA+](#) [MAX4429CPA+](#) [MAX4429CSA+](#) [MAX4429ESA+](#)
[MAX4420MJA/883B](#) [MAX4429MJA/883B](#) [MAX4420ESA-T](#) [MAX4429ESA](#) [MAX4429ESA-T](#) [MAX4420CSA+T](#)
[MAX4420EPA+](#) [MAX4420ESA](#) [MAX4420ESA+T](#) [MAX4429CSA+T](#) [MAX4429EPA+](#) [MAX4429ESA+T](#) [MAX4420CSA-](#)
[T](#) [MAX4429CSA](#) [MAX4429CSA-T](#) [MAX4429EPA](#) [MAX4420CPA](#) [MAX4420CSA](#) [MXT429CPA](#) [MXT429CSA](#)
[MXT429MJA](#) [MXT429CSA-T](#) [MAX4420EPA](#) [MAX4429CPA](#) [5962-8877003PA](#)