

# Contents

1	Absolute maximum ratings and operating conditions .....	5
2	Electrical characteristics .....	6
3	Package information .....	17
4	Ordering information .....	20
5	Revision history .....	20

## List of figures

Figure 1.	Pin connections (top view) . . . . .	1
Figure 2.	Current consumption vs. supply voltage - output low . . . . .	10
Figure 3.	Current consumption vs. supply voltage - output high . . . . .	10
Figure 4.	Current consumption vs. input common mode voltage at $V_{CC} = 1.2\text{ V}$ . . . . .	10
Figure 5.	Current consumption vs. input common mode voltage at $V_{CC} = 5\text{ V}$ . . . . .	10
Figure 6.	Current consumption vs. temperature . . . . .	10
Figure 7.	Current consumption vs. toggle frequency . . . . .	10
Figure 8.	Input offset voltage vs. input common mode voltage at $V_{CC} = 1.2\text{ V}$ . . . . .	11
Figure 9.	Input hysteresis voltage vs. input common mode voltage at $V_{CC} = 1.2\text{ V}$ . . . . .	11
Figure 10.	Input offset voltage vs. input common mode voltage at $V_{CC} = 5\text{ V}$ . . . . .	11
Figure 11.	Input hysteresis voltage vs. input common mode voltage at $V_{CC} = 5\text{ V}$ . . . . .	11
Figure 12.	Input offset voltage vs. temperature . . . . .	11
Figure 13.	Input hysteresis voltage vs. temperature . . . . .	11
Figure 14.	Output voltage drop vs. sink current at $V_{CC} = 1.2\text{ V}$ . . . . .	12
Figure 15.	Output voltage drop vs. source current at $V_{CC} = 1.2\text{ V}$ . . . . .	12
Figure 16.	Output voltage drop vs. sink current at $V_{CC} = 2.7\text{ V}$ . . . . .	12
Figure 17.	Output voltage drop vs. source current at $V_{CC} = 2.7\text{ V}$ . . . . .	12
Figure 18.	Output voltage drop vs. sink current at $V_{CC} = 5\text{ V}$ . . . . .	12
Figure 19.	Output voltage drop vs. source current at $V_{CC} = 5\text{ V}$ . . . . .	12
Figure 20.	Propagation delay $T_{PLH}$ vs. input common mode voltage at $V_{CC} = 1.2\text{ V}$ . . . . .	13
Figure 21.	Propagation delay $T_{PHL}$ vs. input common mode voltage at $V_{CC} = 1.2\text{ V}$ . . . . .	13
Figure 22.	Propagation delay $T_{PLH}$ vs. input common mode voltage at $V_{CC} = 5\text{ V}$ . . . . .	13
Figure 23.	Propagation delay $T_{PHL}$ vs. input common mode voltage at $V_{CC} = 5\text{ V}$ . . . . .	13
Figure 24.	Propagation delay $T_{PLH}$ vs. input signal overdrive at $V_{CC} = 1.2\text{ V}$ . . . . .	13
Figure 25.	Propagation delay $T_{PHL}$ vs. input signal overdrive at $V_{CC} = 1.2\text{ V}$ . . . . .	13
Figure 26.	Propagation delay $T_{PLH}$ vs. input signal overdrive at $V_{CC} = 5\text{ V}$ . . . . .	14
Figure 27.	Propagation delay $T_{PHL}$ vs. input signal overdrive at $V_{CC} = 5\text{ V}$ . . . . .	14
Figure 28.	Propagation delay $T_{PLH}$ vs. supply voltage for signal overdrive 10 mV . . . . .	14
Figure 29.	Propagation delay $T_{PHL}$ vs. supply voltage for signal overdrive 10 mV . . . . .	14
Figure 30.	Propagation delay $T_{PLH}$ vs. supply voltage for signal overdrive 100 mV . . . . .	14
Figure 31.	Propagation delay $T_{PHL}$ vs. supply voltage for signal overdrive 100 mV . . . . .	14
Figure 32.	Propagation delay vs. temperature for signal overdrive 10 mV . . . . .	15
Figure 33.	Propagation delay vs. temperature for signal overdrive 100 mV . . . . .	15
Figure 34.	Input offset voltage vs. input common mode voltage at $V_{CC} = 0.9\text{ V}$ . . . . .	15
Figure 35.	Input voltage hysteresis vs. input common mode voltage at $V_{CC} = 0.9\text{ V}$ . . . . .	15
Figure 36.	Output voltage drop vs. sink current at $V_{CC} = 0.9\text{ V}$ . . . . .	15
Figure 37.	Output voltage drop vs. source current at $V_{CC} = 0.9\text{ V}$ . . . . .	15
Figure 38.	Propagation delay $T_{PLH}$ vs. input common mode voltage at $V_{CC} = 0.9\text{ V}$ and 10 mV signal overdrive . . . . .	16
Figure 39.	Propagation delay $T_{PHL}$ vs. input common mode voltage at $V_{CC} = 0.9\text{ V}$ and 10 mV signal overdrive . . . . .	16
Figure 40.	Propagation delay $T_{PLH}$ vs. input common mode voltage at $V_{CC} = 0.9\text{ V}$ and 100 mV signal overdrive . . . . .	16
Figure 41.	Propagation delay $T_{PHL}$ vs. input common mode voltage at $V_{CC} = 0.9\text{ V}$ and 100 mV signal overdrive . . . . .	16
Figure 42.	Propagation delay $T_{PLH}$ vs. input signal overdrive at $V_{CC} = 0.9\text{ V}$ . . . . .	16
Figure 43.	Propagation delay $T_{PHL}$ vs. input signal overdrive at $V_{CC} = 0.9\text{ V}$ . . . . .	16

---

Figure 44.	SC70-5 (SOT323-5) package outline . . . . .	18
Figure 45.	SOT23-5 - lead small outline transistor package outline . . . . .	19

# 1 Absolute maximum ratings and operating conditions

**Table 1. Absolute maximum ratings**

Symbol	Parameter	Value	Unit
$V_{CC}$	Supply voltage <sup>(1)</sup>	6	V
$V_{ID}$	Differential input voltage <sup>(2)</sup>	±6	V
$V_{IN}$	Input voltage range	$(V_{CC-}) - 0.3$ to $(V_{CC+}) + 0.3$	V
$R_{THJA}$	Thermal resistance junction-to-ambient <sup>(3)</sup>		°C/W
	SC70-5	205	
	SOT23-5	250	
$T_{STG}$	Storage temperature	-65 to +150	°C
$T_J$	Junction temperature	150	°C
$T_{LEAD}$	Lead temperature (soldering 10 seconds)	260	°C
ESD	Human body model (HBM) <sup>(4)</sup>	8000	kV
	Machine model (MM) <sup>(5)</sup>	300	V
	Charged device model (CDM) <sup>(6)</sup>	1300	
	Latch-up immunity	200	mA

1. All voltage values, except differential voltages, are referenced to  $V_{CC-}$ .  $V_{CC}$  is defined as the difference between  $V_{CC+}$  and  $V_{CC-}$ .
2. The magnitude of input and output voltages must never exceed the supply rail ±0.3 V.
3. Short-circuits can cause excessive heating. These values are typical.
4. According to JEDEC standard JESD22-A114F.
5. According to JEDEC standard JESD22-A115A.
6. According to ANSI/ESD STM5.3.1.

**Table 2. Operating conditions**

Symbol	Parameter	Value	Unit
$T_{oper}$	Operating temperature range		°C
	$0.85\text{ V} < V_{CC} < 5.5\text{ V}$	-40 to +85	
	$1.1\text{ V} < V_{CC} < 5.5\text{ V}$	-40 to +125	
$V_{CC}$	Supply voltage		V
	$-40\text{ °C} < T_{amb} < +85\text{ °C}$	0.85 to 5.5	
	$-40\text{ °C} < T_{amb} < +125\text{ °C}$	1.1 to 5.5	
$V_{ICM}$	Common mode input voltage range		V
	$0.85\text{ V} < V_{CC} < 5.5\text{ V}$	-0.2 to +0.2 and $V_{CC-} - 0.2$ to $V_{CC+} + 0.2$	
	$-40\text{ °C} < T_{amb} < +85\text{ °C}$		
	$1.1\text{ V} < V_{CC} < 5.5\text{ V}$	$V_{CC-} - 0.2$ to $V_{CC+} + 0.2$ $V_{CC-}$ to $V_{CC+} + 0.2$	
	$-40\text{ °C} < T_{amb} < +85\text{ °C}$		
	$-40\text{ °C} < T_{amb} < +125\text{ °C}$		

## 2 Electrical characteristics

Table 3.  $V_{CC} = +0.9\text{ V}$ ,  $T_{amb} = +25\text{ °C}$ ,  $V_{ICM} = 0\text{ V}$  (unless otherwise specified)<sup>(1)</sup>

Symbol	Parameter	Test conditions	Min.	Typ.	Max.	Unit
$V_{IO}$	Input offset voltage <sup>(2)</sup>	$-40\text{ °C} < T_{amb} < +85\text{ °C}$	-10 -12	1	10 12	mV
$\Delta V_{IO}$	Input offset voltage drift	$-40\text{ °C} < T_{amb} < +85\text{ °C}$		4.6		$\mu\text{V}/\text{°C}$
$V_{HYST}$	Input hysteresis voltage <sup>(3)</sup>	$-40\text{ °C} < T_{amb} < +85\text{ °C}$	1.0	2.4	4.2	mV
$I_{IO}$	Input offset current <sup>(4)</sup>	$-40\text{ °C} < T_{amb} < +85\text{ °C}$	-10 -100		10 100	pA
$I_{IB}$	Input bias current <sup>(4)</sup>	$-40\text{ °C} < T_{amb} < +85\text{ °C}$	-10 -100		10 100	pA
$I_{CC}$	Supply current per operator	No load, output low, $V_{ID} = -0.1\text{ V}$ $-40\text{ °C} < T_{amb} < +85\text{ °C}$		300	400 450	nA
		No load, output high, $V_{ID} = +0.1\text{ V}$ $-40\text{ °C} < T_{amb} < +85\text{ °C}$		260	350 400	
$I_{SC}$	Short-circuit current	Source Sink		0.2 0.4		mA
$V_{OH}$	Output voltage high	$I_{source} = 50\text{ }\mu\text{A}$ $-40\text{ °C} < T_{amb} < +85\text{ °C}$	0.85 0.83	0.87		V
$V_{OL}$	Output voltage low	$I_{sink} = 50\text{ }\mu\text{A}$ $-40\text{ °C} < T_{amb} < +85\text{ °C}$		20	50 70	mV
$T_{PLH}$	Propagation delay (low to high)	$f = 1\text{ kHz}$ , $C_L = 30\text{ pF}$ , $R_L = 1\text{ M}\Omega$ Overdrive = 10 mV $-40\text{ °C} < T_{amb} < +85\text{ °C}$		7.2	14 16	$\mu\text{s}$
		Overdrive = 100 mV $-40\text{ °C} < T_{amb} < +85\text{ °C}$		3.3	5.0 5.5	
$T_{PHL}$	Propagation delay (high to low)	$f = 1\text{ kHz}$ , $C_L = 30\text{ pF}$ , $R_L = 1\text{ M}\Omega$ Overdrive = 10 mV $-40\text{ °C} < T_{amb} < +85\text{ °C}$		6.0	11 12	$\mu\text{s}$
		Overdrive = 100 mV $-40\text{ °C} < T_{amb} < +85\text{ °C}$		2.5	4.5 5.0	
$T_R$	Rise time (10% to 90%)	$C_L = 30\text{ pF}$ , $R_L = 1\text{ M}\Omega$		160		ns
$T_F$	Fall time (90% to 10%)	$C_L = 30\text{ pF}$ , $R_L = 1\text{ M}\Omega$		140		ns
$T_{ON}$	Power-up time			1.1	1.7	ms

1. All values over the temperature range are guaranteed through correlation and simulation. No production test is performed at the temperature range limits.
2. The offset is defined as the average value of positive and negative trip points (input voltage differences requested to change the output state in each direction).
3. The hysteresis is a built-in feature of the TS881 device. It is defined as the voltage difference between the trip points.
4. Maximum values are guaranteed by design.

Table 4.  $V_{CC} = +1.2\text{ V}$ ,  $T_{amb} = +25\text{ }^{\circ}\text{C}$ ,  $V_{ICM} = V_{CC}/2$  (unless otherwise specified)<sup>(1)</sup>

Symbol	Parameter	Test conditions	Min.	Typ.	Max.	Unit
$V_{IO}$	Input offset voltage <sup>(2)</sup>	$-40\text{ }^{\circ}\text{C} < T_{amb} < +125\text{ }^{\circ}\text{C}$	-6	1	6	mV
$\Delta V_{IO}$	Input offset voltage drift	$-40\text{ }^{\circ}\text{C} < T_{amb} < +125\text{ }^{\circ}\text{C}$		3		$\mu\text{V}/^{\circ}\text{C}$
$V_{HYST}$	Input hysteresis voltage <sup>(3)</sup>	$-40\text{ }^{\circ}\text{C} < T_{amb} < +125\text{ }^{\circ}\text{C}$	1.6	2.4	4.2	mV
$I_{IO}$	Input offset current <sup>(4)</sup>	$-40\text{ }^{\circ}\text{C} < T_{amb} < +125\text{ }^{\circ}\text{C}$	-10 -100		10 100	pA
$I_{IB}$	Input bias current <sup>(4)</sup>	$-40\text{ }^{\circ}\text{C} < T_{amb} < +125\text{ }^{\circ}\text{C}$	-10 -100	1	10 100	pA
$I_{CC}$	Supply current per operator	No load, output low, $V_{ID} = -0.1\text{ V}$ $-40\text{ }^{\circ}\text{C} < T_{amb} < +85\text{ }^{\circ}\text{C}$ $-40\text{ }^{\circ}\text{C} < T_{amb} < +125\text{ }^{\circ}\text{C}$  No load, output high, $V_{ID} = +0.1\text{ V}$ $-40\text{ }^{\circ}\text{C} < T_{amb} < +85\text{ }^{\circ}\text{C}$ $-40\text{ }^{\circ}\text{C} < T_{amb} < +125\text{ }^{\circ}\text{C}$		300  210	450 500 1050  350 400 950	nA
$I_{SC}$	Short-circuit current	Source Sink		1.4 1.0		mA
$V_{OH}$	Output voltage high	$I_{source} = 0.2\text{ mA}$ $-40\text{ }^{\circ}\text{C} < T_{amb} < +85\text{ }^{\circ}\text{C}$ $-40\text{ }^{\circ}\text{C} < T_{amb} < +125\text{ }^{\circ}\text{C}$	1.13 1.10 1.00	1.15		V
$V_{OL}$	Output voltage low	$I_{sink} = 0.2\text{ mA}$ $-40\text{ }^{\circ}\text{C} < T_{amb} < +85\text{ }^{\circ}\text{C}$ $-40\text{ }^{\circ}\text{C} < T_{amb} < +125\text{ }^{\circ}\text{C}$		40	50 60 70	mV
CMRR	Common mode rejection ratio	$0 < V_{ICM} < V_{CC}$ $-40\text{ }^{\circ}\text{C} < T_{amb} < +125\text{ }^{\circ}\text{C}$	50	68		dB
$T_{PLH}$	Propagation delay (low to high)	$f = 1\text{ kHz}$ , $C_L = 30\text{ pF}$ , $R_L = 1\text{ M}\Omega$ Overdrive = 10 mV $-40\text{ }^{\circ}\text{C} < T_{amb} < +125\text{ }^{\circ}\text{C}$  Overdrive = 100 mV $-40\text{ }^{\circ}\text{C} < T_{amb} < +125\text{ }^{\circ}\text{C}$		6  2.2	11 13  3.1 3.4	$\mu\text{s}$
$T_{PHL}$	Propagation delay (high to low)	$f = 1\text{ kHz}$ , $C_L = 30\text{ pF}$ , $R_L = 1\text{ M}\Omega$ Overdrive = 10 mV $-40\text{ }^{\circ}\text{C} < T_{amb} < +125\text{ }^{\circ}\text{C}$  Overdrive = 100 mV $-40\text{ }^{\circ}\text{C} < T_{amb} < +125\text{ }^{\circ}\text{C}$		5.1  2.0	8 10  2.6 3.1	$\mu\text{s}$
$T_R$	Rise time (10% to 90%)	$C_L = 30\text{ pF}$ , $R_L = 1\text{ M}\Omega$		100		ns
$T_F$	Fall time (90% to 10%)	$C_L = 30\text{ pF}$ , $R_L = 1\text{ M}\Omega$		110		ns
$T_{ON}$	Power-up time			1.0	1.5	ms

1. All values over the temperature range are guaranteed through correlation and simulation. No production test is performed at the temperature range limits.
2. The offset is defined as the average value of positive and negative trip points (input voltage differences requested to change the output state in each direction).
3. The hysteresis is a built-in feature of the TS881 device. It is defined as the voltage difference between the trip points.
4. Maximum values are guaranteed by design.

**Table 5.  $V_{CC} = +2.7\text{ V}$ ,  $T_{amb} = +25\text{ °C}$ ,  $V_{ICM} = V_{CC}/2$  (unless otherwise specified)<sup>(1)</sup>**

Symbol	Parameter	Test conditions	Min.	Typ.	Max.	Unit
$V_{IO}$	Input offset voltage <sup>(2)</sup>	$-40\text{ °C} < T_{amb} < +125\text{ °C}$	-6	1	6	mV
$\Delta V_{IO}$	Input offset voltage drift	$-40\text{ °C} < T_{amb} < +125\text{ °C}$		3		$\mu\text{V}/\text{°C}$
$V_{HYST}$	Input hysteresis voltage <sup>(3)</sup>	$-40\text{ °C} < T_{amb} < +125\text{ °C}$	1.6	2.7	4.2	mV
$I_{IO}$	Input offset current <sup>(4)</sup>	$-40\text{ °C} < T_{amb} < +125\text{ °C}$	-10 -100		10 100	pA
$I_{IB}$	Input bias current <sup>(4)</sup>	$-40\text{ °C} < T_{amb} < +125\text{ °C}$	-10 -100	1	10 100	pA
$I_{CC}$	Supply current per operator	No load, output low, $V_{ID} = -0.1\text{ V}$ $-40\text{ °C} < T_{amb} < +85\text{ °C}$ $-40\text{ °C} < T_{amb} < +125\text{ °C}$ No load, output high, $V_{ID} = +0.1\text{ V}$ $-40\text{ °C} < T_{amb} < +85\text{ °C}$ $-40\text{ °C} < T_{amb} < +125\text{ °C}$		310 220	450 500 1150 350 400 1050	nA
$I_{SC}$	Short-circuit current	Source Sink		12 10		mA
$V_{OH}$	Output voltage high	$I_{source} = 2\text{ mA}$ $-40\text{ °C} < T_{amb} < +85\text{ °C}$ $-40\text{ °C} < T_{amb} < +125\text{ °C}$	2.48 2.40 2.10	2.51		V
$V_{OL}$	Output voltage low	$I_{sink} = 2\text{ mA}$ $-40\text{ °C} < T_{amb} < +85\text{ °C}$ $-40\text{ °C} < T_{amb} < +125\text{ °C}$		140	210 230 310	mV
CMRR	Common mode rejection ratio	$0 < V_{ICM} < V_{CC}$ $-40\text{ °C} < T_{amb} < +125\text{ °C}$	55	74		dB
$T_{PLH}$	Propagation delay (low to high)	$f = 1\text{ kHz}$ , $C_L = 30\text{ pF}$ , $R_L = 1\text{ M}\Omega$ Overdrive = 10 mV $-40\text{ °C} < T_{amb} < +125\text{ °C}$ Overdrive = 100 mV $-40\text{ °C} < T_{amb} < +125\text{ °C}$		6.3 2.4	12 13 3.0 3.7	$\mu\text{s}$
$T_{PHL}$	Propagation delay (high to low)	$f = 1\text{ kHz}$ , $C_L = 30\text{ pF}$ , $R_L = 1\text{ M}\Omega$ Overdrive = 10 mV $-40\text{ °C} < T_{amb} < +125\text{ °C}$ Overdrive = 100 mV $-40\text{ °C} < T_{amb} < +125\text{ °C}$		6.4 2.3	12 14 3.0 3.7	$\mu\text{s}$
$T_R$	Rise time (10% to 90%)	$C_L = 30\text{ pF}$ , $R_L = 1\text{ M}\Omega$		120		ns
$T_F$	Fall time (90% to 10%)	$C_L = 30\text{ pF}$ , $R_L = 1\text{ M}\Omega$		130		ns
$T_{ON}$	Power-up time			0.9	1.5	ms

1. All values over the temperature range are guaranteed through correlation and simulation. No production test is performed at the temperature range limits.
2. The offset is defined as the average value of positive and negative trip points (input voltage differences requested to change the output state in each direction).
3. The hysteresis is a built-in feature of the TS881. It is defined as the voltage difference between the trip points.
4. Maximum values are guaranteed by design.

Table 6.  $V_{CC} = +5\text{ V}$ ,  $T_{amb} = +25\text{ °C}$ ,  $V_{ICM} = V_{CC}/2$  (unless otherwise specified)<sup>(1)</sup>

Symbol	Parameter	Test conditions	Min.	Typ.	Max.	Unit
$V_{IO}$	Input offset voltage <sup>(2)</sup>	$-40\text{ °C} < T_{amb} < +125\text{ °C}$	-6	1	6	mV
$\Delta V_{IO}$	Input offset voltage drift	$-40\text{ °C} < T_{amb} < +125\text{ °C}$		3		$\mu\text{V}/\text{°C}$
$V_{HYST}$	Input hysteresis voltage <sup>(3)</sup>	$-40\text{ °C} < T_{amb} < +125\text{ °C}$	1.6	3.1	4.2	mV
$I_{IO}$	Input offset current <sup>(4)</sup>	$-40\text{ °C} < T_{amb} < +125\text{ °C}$	-10 -100		10 100	$\mu\text{A}$
$I_{IB}$	Input bias current <sup>(4)</sup>	$-40\text{ °C} < T_{amb} < +125\text{ °C}$	-10 -100	1	10 100	$\mu\text{A}$
$I_{CC}$	Supply current per operator	No load, output low, $V_{ID} = -0.1\text{ V}$ $-40\text{ °C} < T_{amb} < +85\text{ °C}$ $-40\text{ °C} < T_{amb} < +125\text{ °C}$ No load, output high, $V_{ID} = +0.1\text{ V}$ $-40\text{ °C} < T_{amb} < +85\text{ °C}$ $-40\text{ °C} < T_{amb} < +125\text{ °C}$		350 250	500 750 1350 400 650 1250	nA
$I_{SC}$	Short-circuit current	Source Sink		32 36		mA
$V_{OH}$	Output voltage high	$I_{source} = 2\text{ mA}$ $-40\text{ °C} < T_{amb} < +85\text{ °C}$ $-40\text{ °C} < T_{amb} < +125\text{ °C}$	4.86 4.75 4.60	4.90		V
$V_{OL}$	Output voltage low	$I_{sink} = 2\text{ mA}$ $-40\text{ °C} < T_{amb} < +85\text{ °C}$ $-40\text{ °C} < T_{amb} < +125\text{ °C}$		95	130 170 280	mV
CMRR	Common mode rejection ratio	$0 < V_{ICM} < V_{CC}$ $-40\text{ °C} < T_{amb} < +125\text{ °C}$	55	78		dB
SVR	Supply voltage rejection	$\Delta V_{CC} = 1.2\text{ V to } 5\text{ V}$ $-40\text{ °C} < T_{amb} < +125\text{ °C}$	65	80		dB
$T_{PLH}$	Propagation delay (low to high)	$f = 1\text{ kHz}$ , $C_L = 30\text{ pF}$ , $R_L = 1\text{ M}\Omega$ Overdrive = 10 mV $-40\text{ °C} < T_{amb} < +125\text{ °C}$ Overdrive = 100 mV $-40\text{ °C} < T_{amb} < +125\text{ °C}$		7.8 2.6	13 22 3.4 4.1	$\mu\text{s}$
$T_{PHL}$	Propagation delay (high to low)	$f = 1\text{ kHz}$ , $C_L = 30\text{ pF}$ , $R_L = 1\text{ M}\Omega$ Overdrive = 10 mV $-40\text{ °C} < T_{amb} < +125\text{ °C}$ Overdrive = 100 mV $-40\text{ °C} < T_{amb} < +125\text{ °C}$		8.9 2.7	16 19 3.5 4.2	$\mu\text{s}$
$T_R$	Rise time (10% to 90%)	$C_L = 30\text{ pF}$ , $R_L = 1\text{ M}\Omega$		160		ns
$T_F$	Fall time (90% to 10%)	$C_L = 30\text{ pF}$ , $R_L = 1\text{ M}\Omega$		150		ns
$T_{ON}$	Power-up time			1.1	1.5	ms

1. All values over the temperature range are guaranteed through correlation and simulation. No production test is performed at the temperature range limits.
2. The offset is defined as the average value of positive and negative trip points (input voltage differences requested to change the output state in each direction).
3. The hysteresis is a built-in feature of the TS881 device. It is defined as the voltage difference between the trip points.
4. Maximum values are guaranteed by design.



Figure 2. Current consumption vs. supply voltage - output low

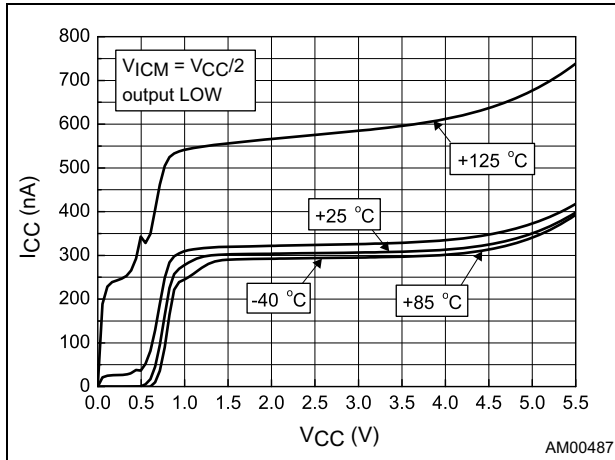

Figure 3. Current consumption vs. supply voltage - output high

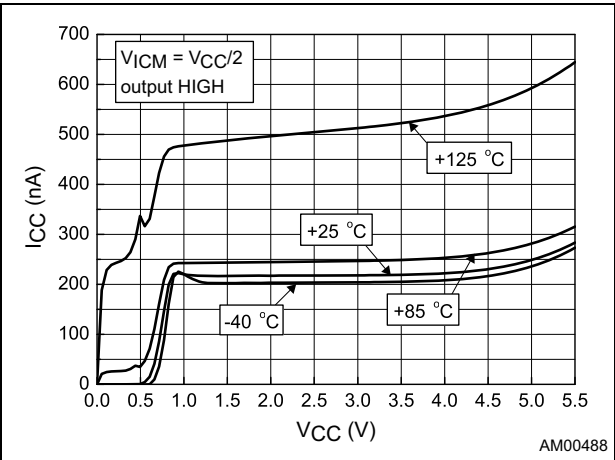

Figure 4. Current consumption vs. input common mode voltage at VCC = 1.2 V

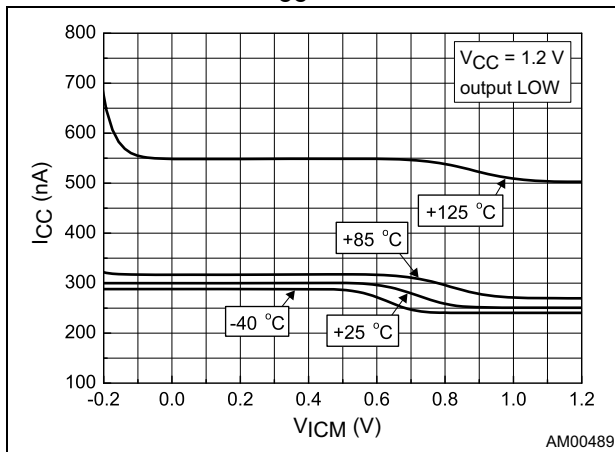

Figure 5. Current consumption vs. input common mode voltage at VCC = 5 V

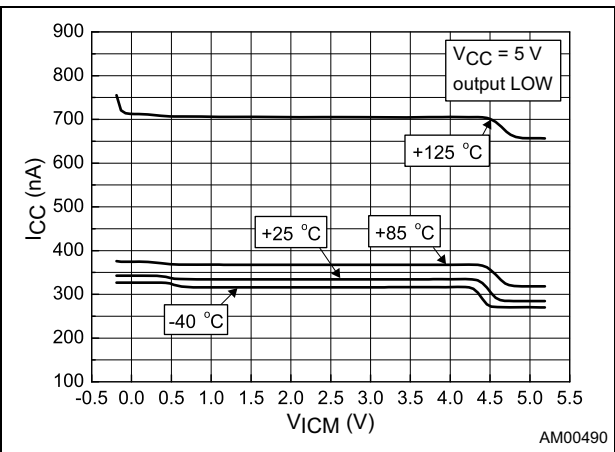

Figure 6. Current consumption vs. temperature

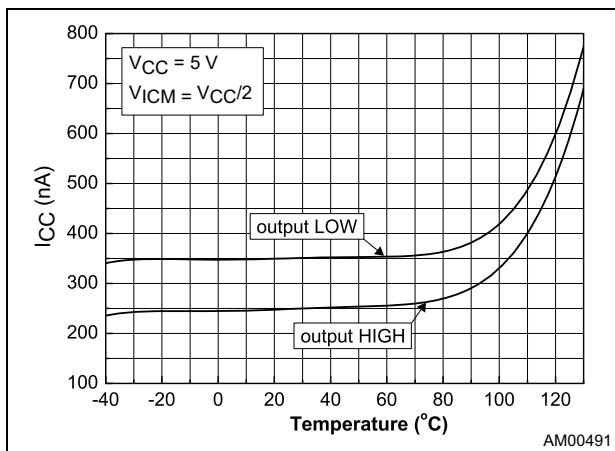

Figure 7. Current consumption vs. toggle frequency

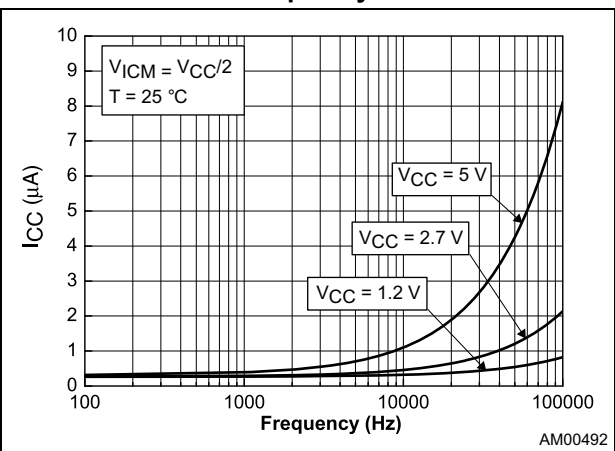

Figure 8. Input offset voltage vs. input common mode voltage at  $V_{CC} = 1.2\text{ V}$

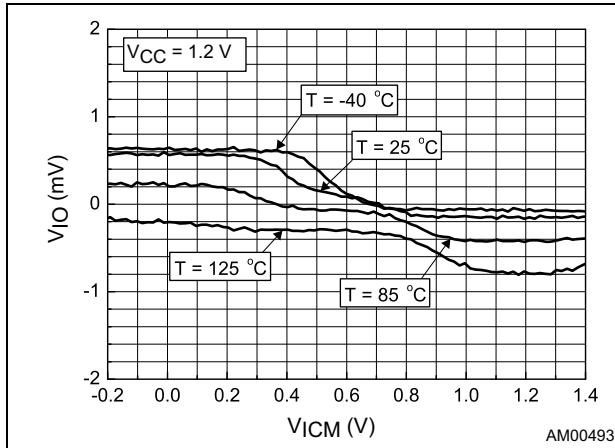

Figure 9. Input hysteresis voltage vs. input common mode voltage at  $V_{CC} = 1.2\text{ V}$

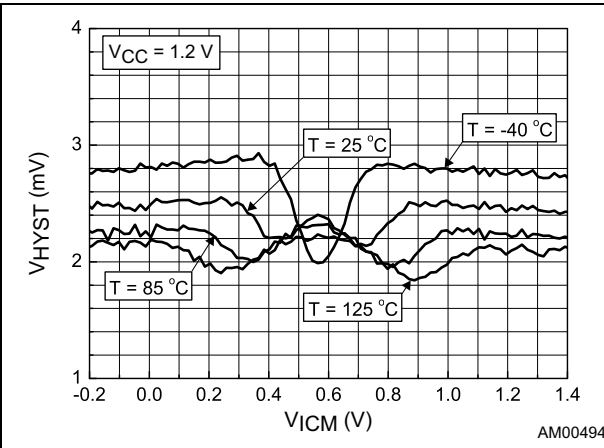

Figure 10. Input offset voltage vs. input common mode voltage at  $V_{CC} = 5\text{ V}$

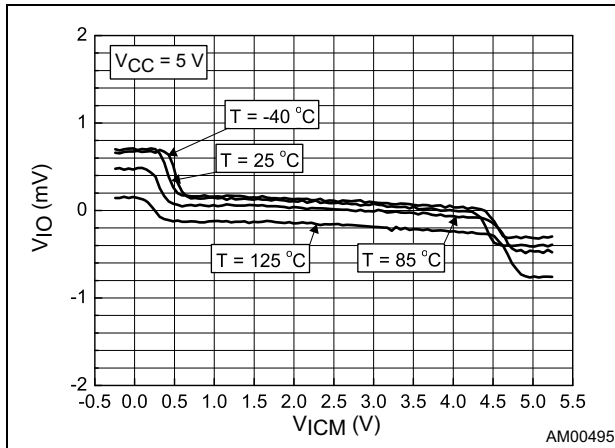

Figure 11. Input hysteresis voltage vs. input common mode voltage at  $V_{CC} = 5\text{ V}$

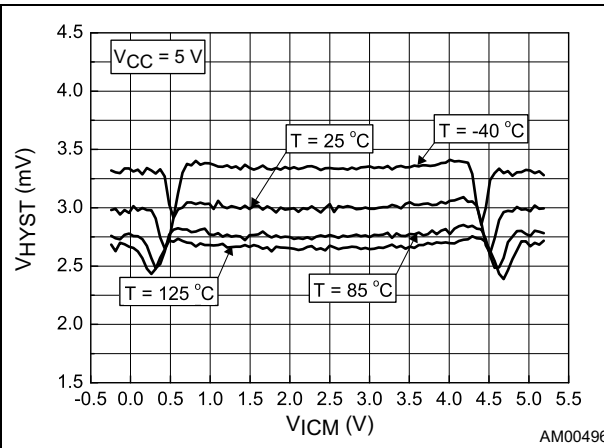

Figure 12. Input offset voltage vs. temperature

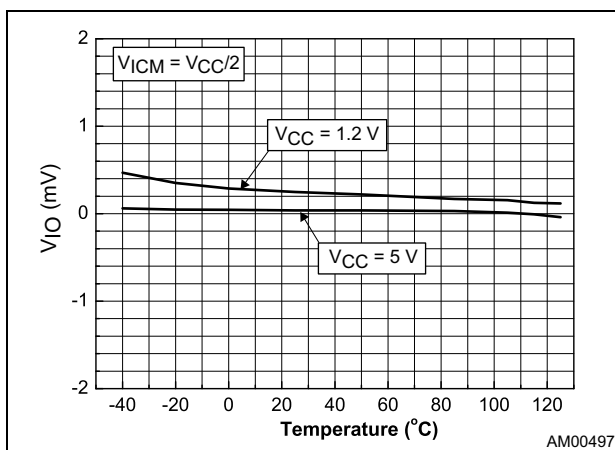

Figure 13. Input hysteresis voltage vs. temperature

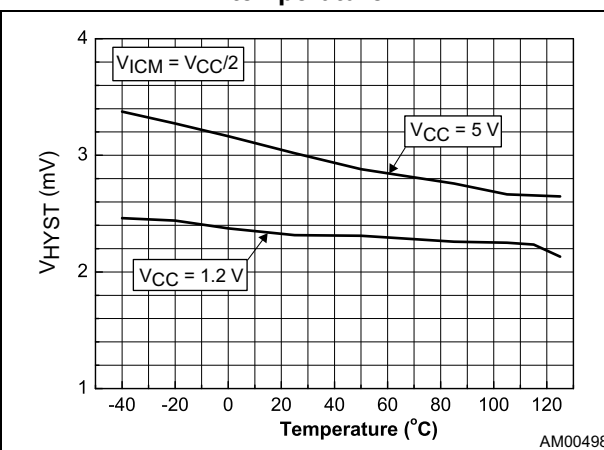

Figure 14. Output voltage drop vs. sink current at  $V_{CC} = 1.2\text{ V}$

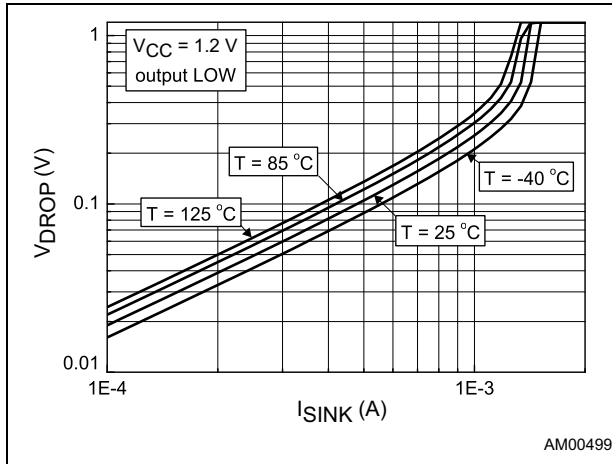

Figure 15. Output voltage drop vs. source current at  $V_{CC} = 1.2\text{ V}$

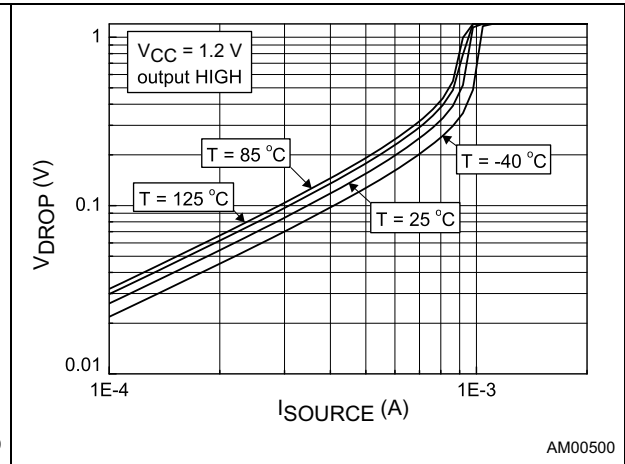

Figure 16. Output voltage drop vs. sink current at  $V_{CC} = 2.7\text{ V}$

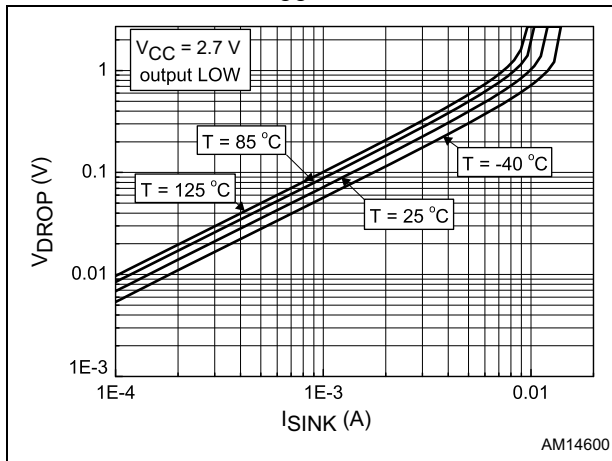

Figure 17. Output voltage drop vs. source current at  $V_{CC} = 2.7\text{ V}$

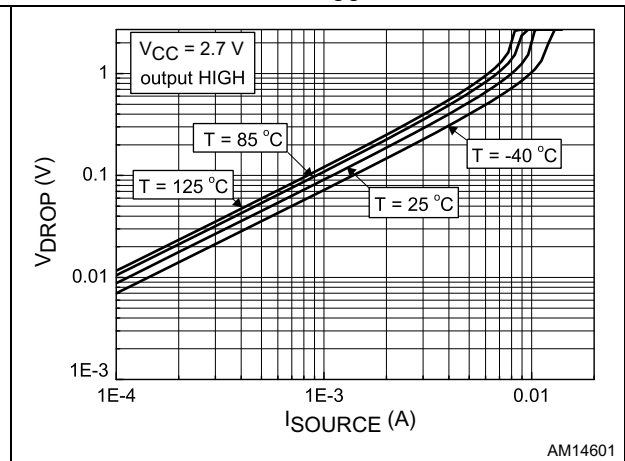

Figure 18. Output voltage drop vs. sink current at  $V_{CC} = 5\text{ V}$

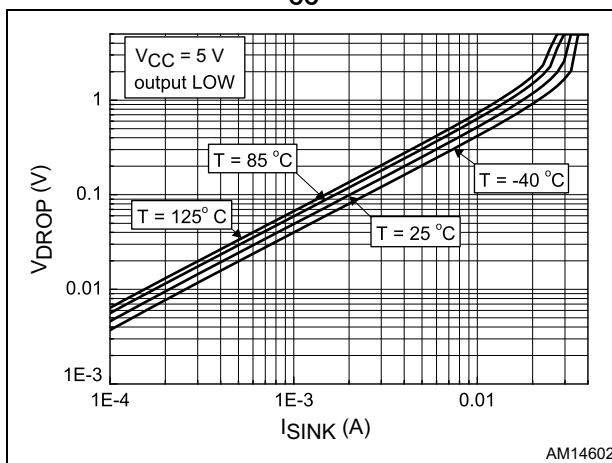

Figure 19. Output voltage drop vs. source current at  $V_{CC} = 5\text{ V}$

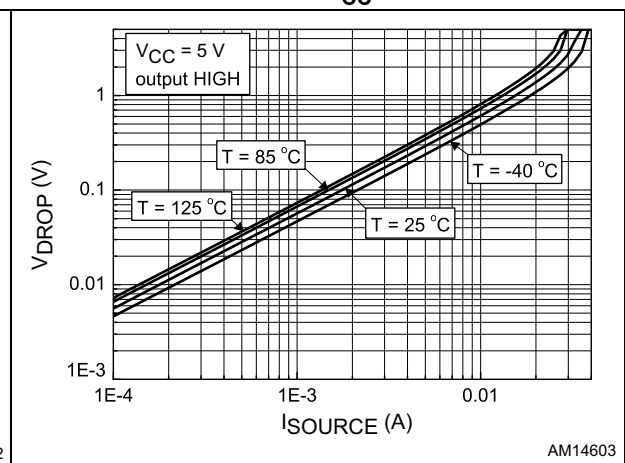

Figure 20. Propagation delay  $T_{PLH}$  vs. input common mode voltage at  $V_{CC} = 1.2\text{ V}$

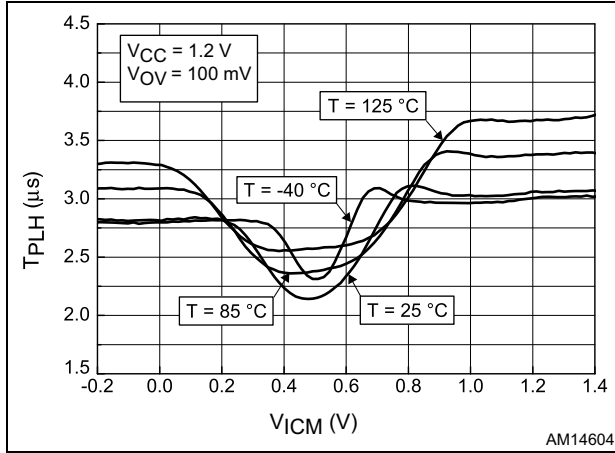

Figure 21. Propagation delay  $T_{PHL}$  vs. input common mode voltage at  $V_{CC} = 1.2\text{ V}$

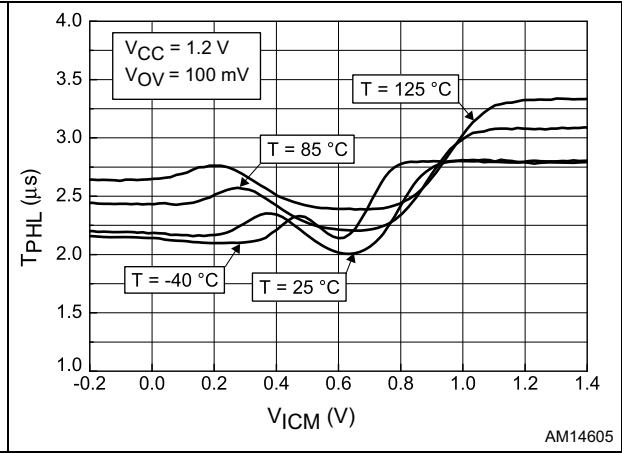

Figure 22. Propagation delay  $T_{PLH}$  vs. input common mode voltage at  $V_{CC} = 5\text{ V}$

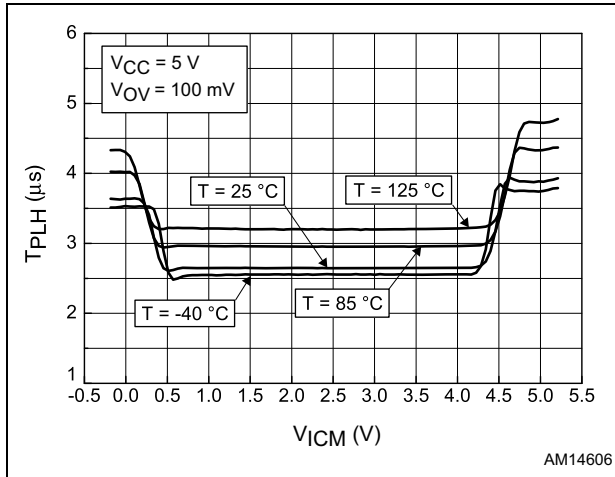

Figure 23. Propagation delay  $T_{PHL}$  vs. input common mode voltage at  $V_{CC} = 5\text{ V}$

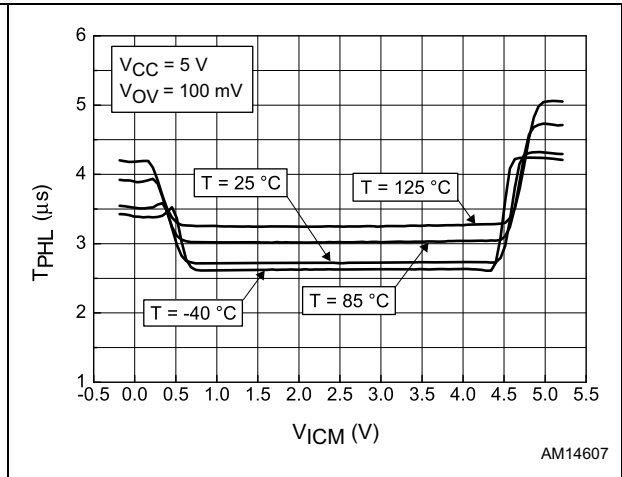

Figure 24. Propagation delay  $T_{PLH}$  vs. input signal overdrive at  $V_{CC} = 1.2\text{ V}$

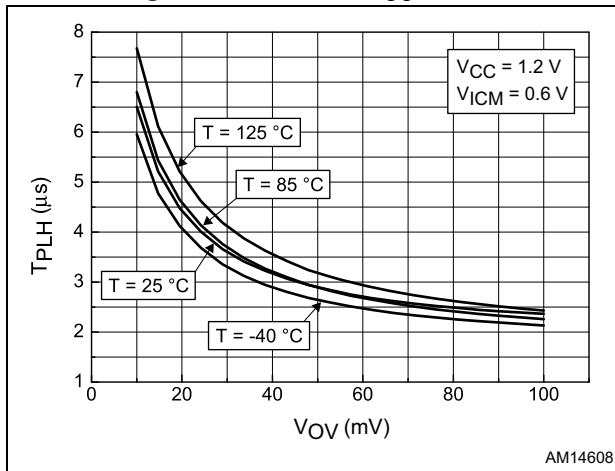

Figure 25. Propagation delay  $T_{PHL}$  vs. input signal overdrive at  $V_{CC} = 1.2\text{ V}$

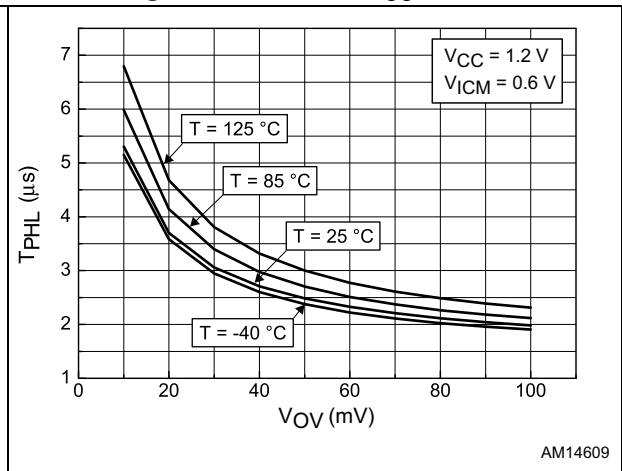

Figure 26. Propagation delay  $T_{PLH}$  vs. input signal overdrive at  $V_{CC} = 5\text{ V}$

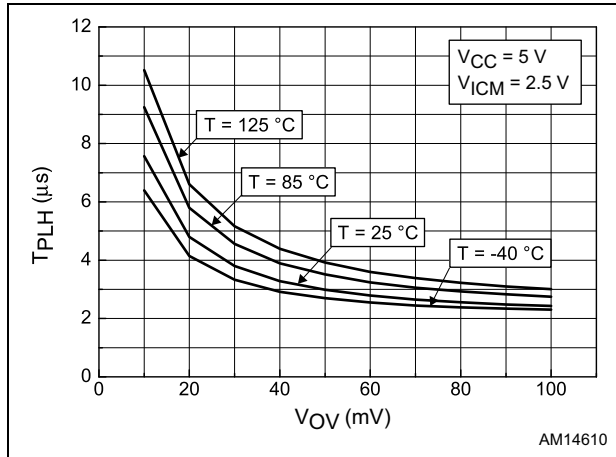

Figure 27. Propagation delay  $T_{PHL}$  vs. input signal overdrive at  $V_{CC} = 5\text{ V}$

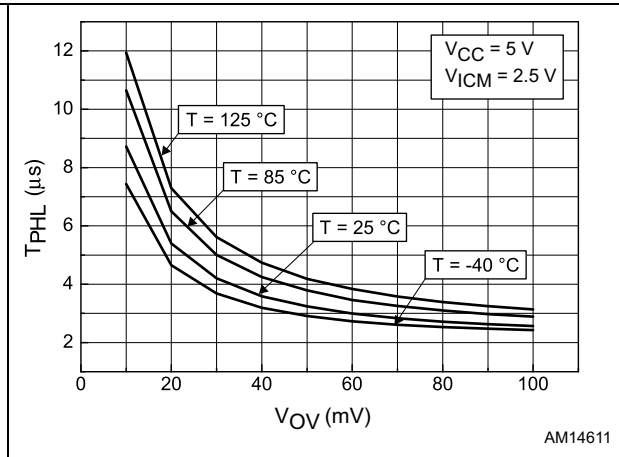

Figure 28. Propagation delay  $T_{PLH}$  vs. supply voltage for signal overdrive 10 mV

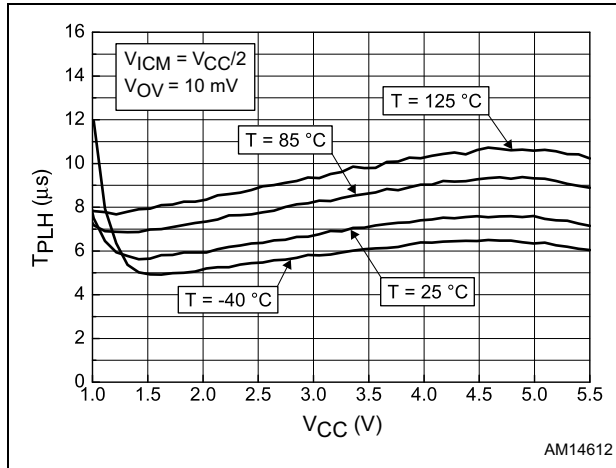

Figure 29. Propagation delay  $T_{PHL}$  vs. supply voltage for signal overdrive 10 mV

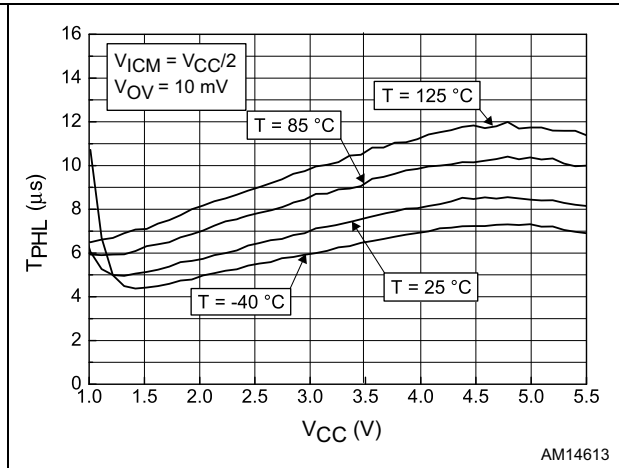

Figure 30. Propagation delay  $T_{PLH}$  vs. supply voltage for signal overdrive 100 mV

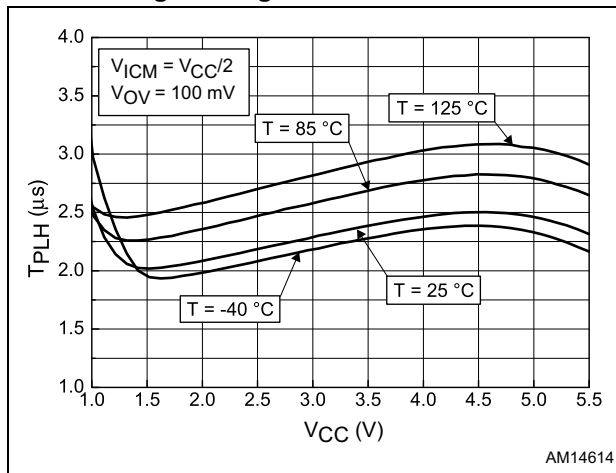

Figure 31. Propagation delay  $T_{PHL}$  vs. supply voltage for signal overdrive 100 mV

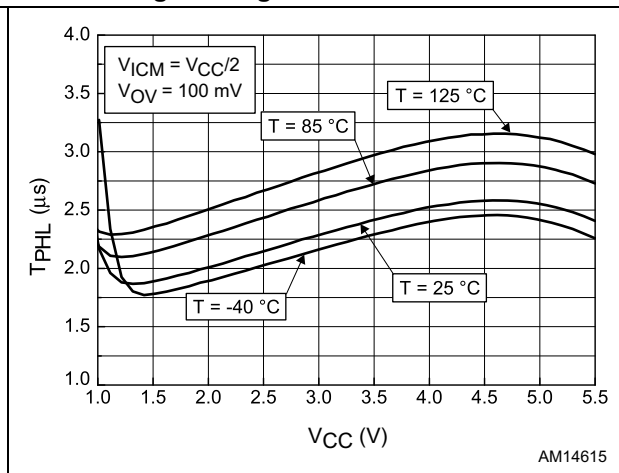

Figure 32. Propagation delay vs. temperature for signal overdrive 10 mV

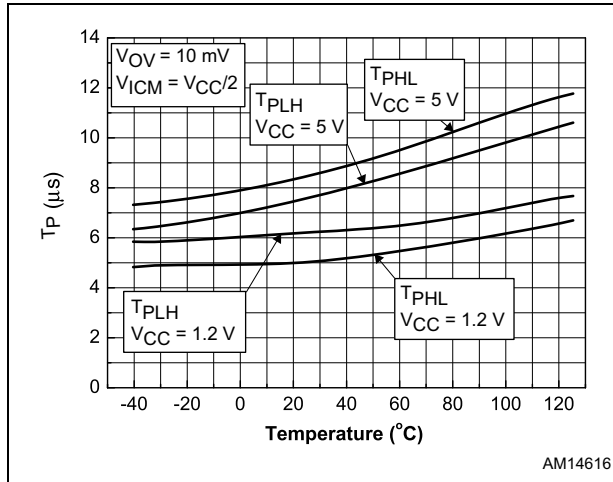

Figure 33. Propagation delay vs. temperature for signal overdrive 100 mV

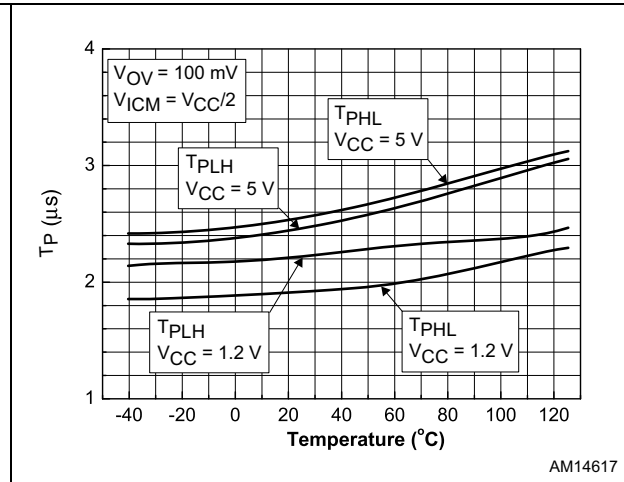

Figure 34. Input offset voltage vs. input common mode voltage at  $V_{CC} = 0.9V$

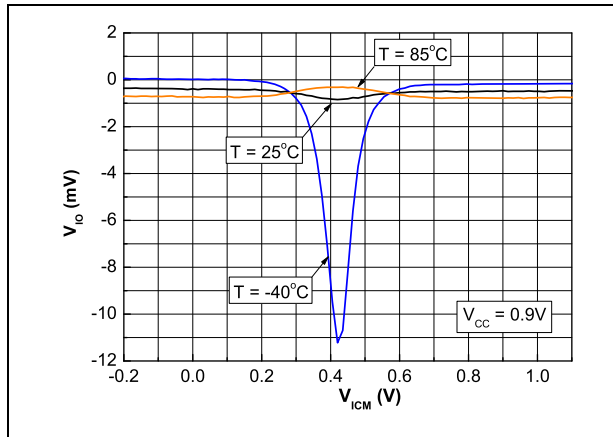

Figure 35. Input voltage hysteresis vs. input common mode voltage at  $V_{CC} = 0.9V$

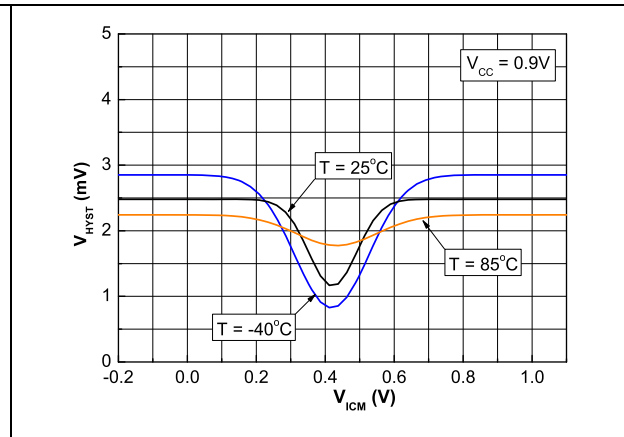

Figure 36. Output voltage drop vs. sink current at  $V_{CC} = 0.9V$

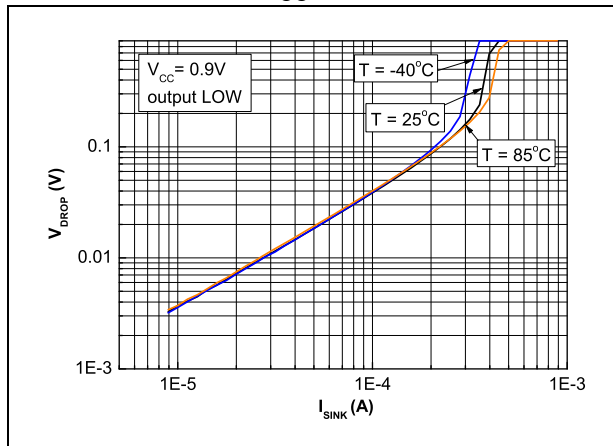
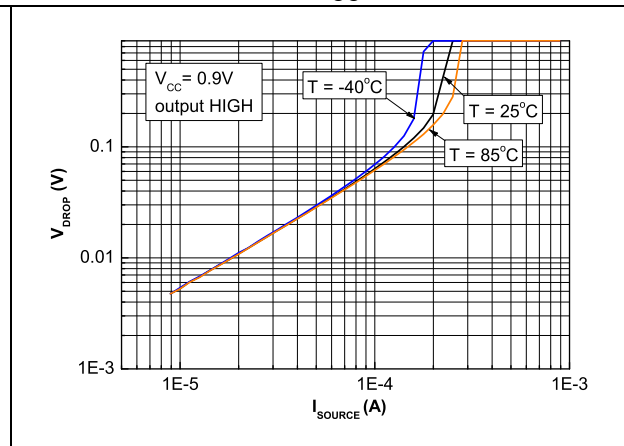
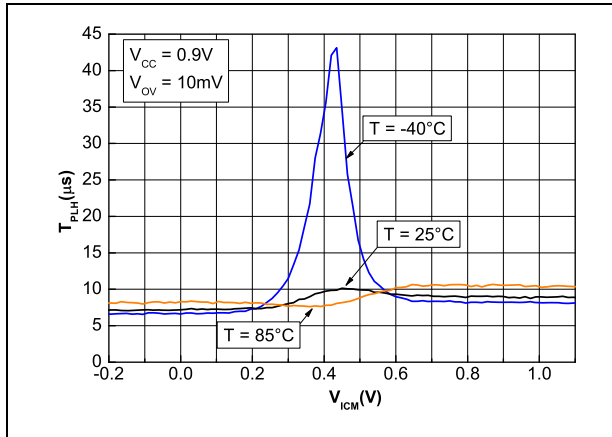

Figure 37. Output voltage drop vs. source current at  $V_{CC} = 0.9V$



**Figure 38. Propagation delay  $T_{PLH}$  vs. input common mode voltage at  $V_{CC} = 0.9\text{ V}$  and  $10\text{ mV}$  signal overdrive**



**Figure 39. Propagation delay  $T_{PHL}$  vs. input common mode voltage at  $V_{CC} = 0.9\text{ V}$  and  $10\text{ mV}$  signal overdrive**

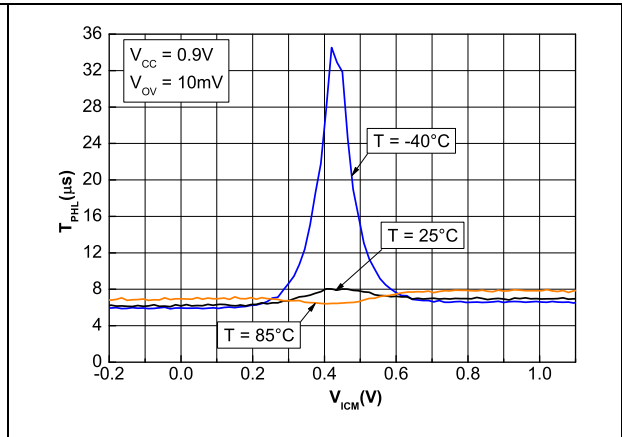

**Figure 40. Propagation delay  $T_{PLH}$  vs. input common mode voltage at  $V_{CC} = 0.9\text{ V}$  and  $100\text{ mV}$  signal overdrive**

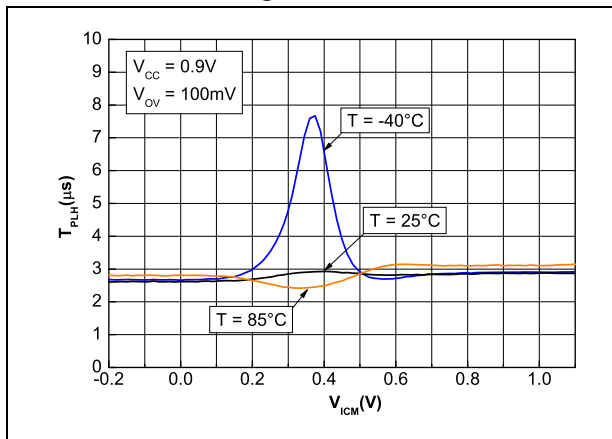

**Figure 41. Propagation delay  $T_{PHL}$  vs. input common mode voltage at  $V_{CC} = 0.9\text{ V}$  and  $100\text{ mV}$  signal overdrive**

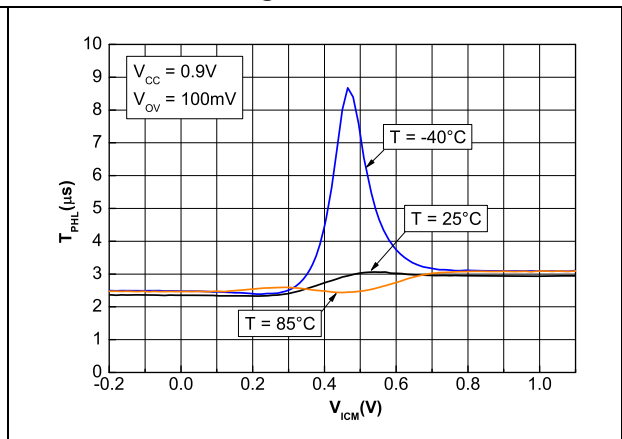

**Figure 42. Propagation delay  $T_{PLH}$  vs. input signal overdrive at  $V_{CC} = 0.9\text{ V}$**

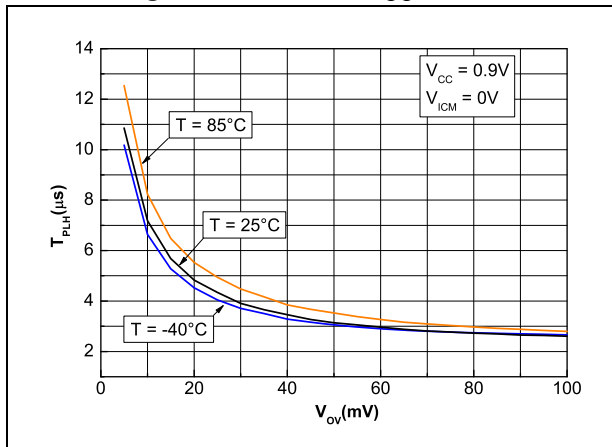

**Figure 43. Propagation delay  $T_{PHL}$  vs. input signal overdrive at  $V_{CC} = 0.9\text{ V}$**

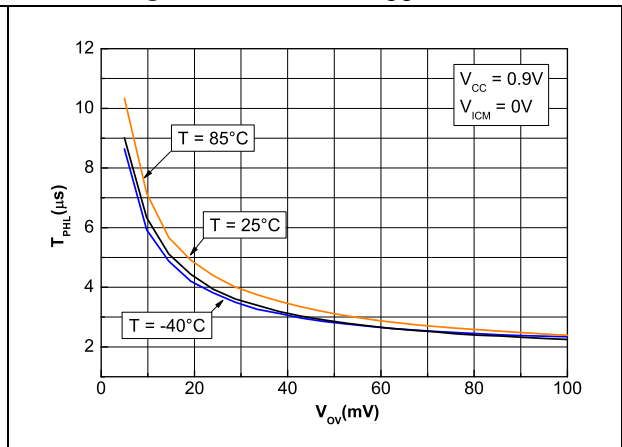

### 3 Package information

In order to meet environmental requirements, ST offers these devices in different grades of ECOPACK® packages, depending on their level of environmental compliance. ECOPACK specifications, grade definitions and product status are available at: [www.st.com](http://www.st.com). ECOPACK is an ST trademark.



Figure 44. SC70-5 (SOT323-5) package outline

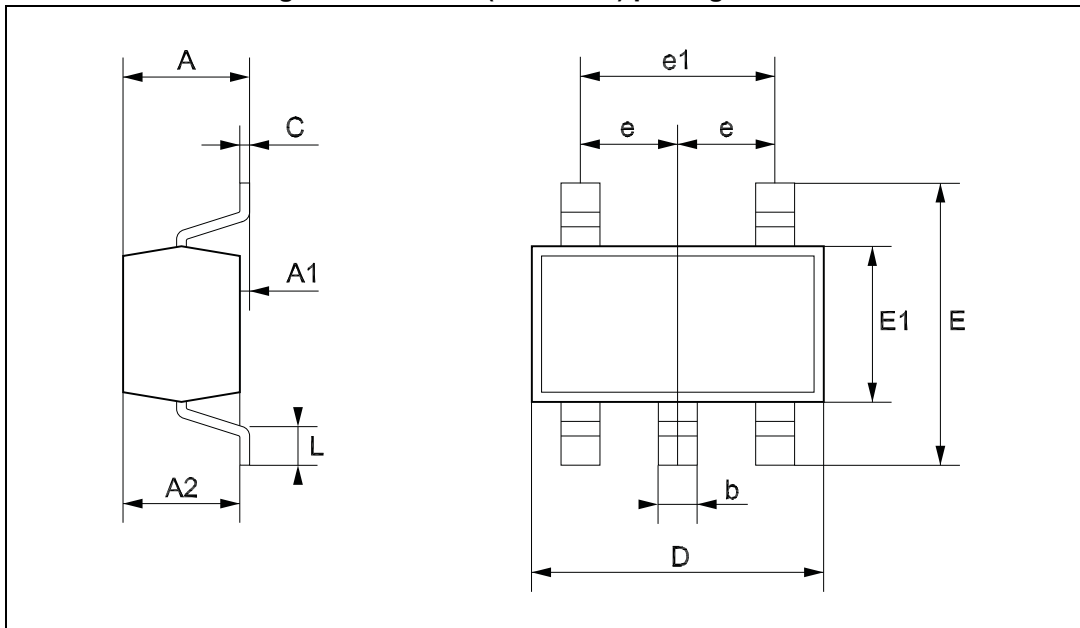

Table 7. SC70-5 (SOT323-5) package mechanical data

Symbol	Dimensions					
	Millimeters			Mils		
	Min.	Typ.	Max.	Min.	Typ.	Max.
A	0.80		1.10	31.5		43.3
A1	0.00		0.10	0.0		3.9
A2	0.80	0.9	1.00	31.5	35.4	39.4
b	0.15		0.30	5.9		11.8
C	0.10		0.22	3.9		8.7
D	1.80		2.20	70.9		86.6
E	1.80		2.40	70.9		94.5
E1	1.15	1.25	1.35	45.3	49.2	53.1
e		0.65			25.6	
e1		1.3			51.2	
L	0.26	0.36	0.46	10.2	14.2	18.1

Figure 45. SOT23-5 - lead small outline transistor package outline

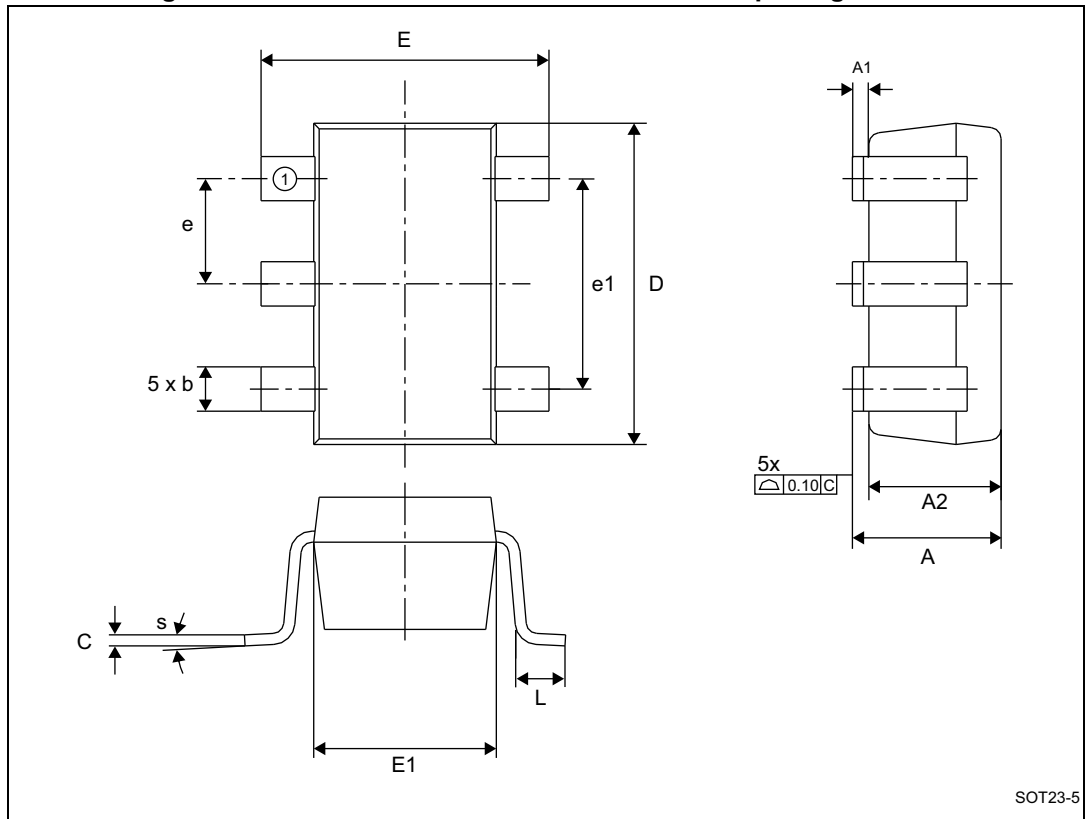

Table 8. SOT23-5 - lead small outline transistor package mechanical data

Symbol	Dimensions					
	Millimeters			Inches		
	Typ.	Min.	Max.	Typ.	Min.	Max.
A			1.45			0.057
A1		0.00	0.15		0.000	0.006
A2	1.15	0.90	1.30	0.045	0.035	0.051
b		0.30	0.50		0.012	0.020
c		0.08	0.22		0.003	0.009
D	2.90			0.114		
E	2.80			0.110		
E1	1.60			0.063		
e	0.95			0.037		
e1	1.90			0.075		
L	0.45	0.30	0.60	0.018	0.012	0.024
q	4	0	8	4	0	8
N	5			5		

## 4 Ordering information

Table 9. Order codes

Order code	Temperature range	Package	Packaging	Marking
TS881ICT	-40 to +125 °C	SC70-5	Tape and reel	K56
TS881ILT	-40 to +125 °C	SOT23-5	Tape and reel	K524

## 5 Revision history

Table 10. Document revision history

Date	Revision	Changes
18-Jul-2012	1	Initial release.
16-Dec-2013	2	<p>Updated title <a href="#">on page 1</a> (replaced 1.1 V by 0.9 V).</p> <p>Added package SOT23-5 and package information: <a href="#">on page 1</a>, in <a href="#">Section : Description on page 1, Figure 1: Pin connections (top view) on page 1, Table 1, Section 3: Package information, Section 4: Ordering information</a>.</p> <p>Updated <a href="#">Section : Features on page 1</a> (replaced “Supply operation” from “1.1 V to 5.5 V” to “0.85 V to 5.5 V”, HBM changed from 4 kV to 8 kV).</p> <p>Updated <a href="#">Section : Description on page 1</a> (replaced 1.1 by 0.85 V).</p> <p>Updated <a href="#">Table 1</a> (changed ESD HBM to 8000 V).</p> <p>Updated <a href="#">Table 2</a> (updated and added parameters and values).</p> <p>Updated <a href="#">Section 2: Electrical characteristics</a>:</p> <ul style="list-style-type: none"> <li>– Added <a href="#">Table 3</a>.</li> <li>– Updated <a href="#">Table 4, Table 5, Table 6</a> (added min. values for <math>I_{IO}</math> and <math>I_{IB}</math> symbols).</li> <li>– Note <a href="#">4.</a> below <a href="#">Table 4.</a>, note <a href="#">4.</a> below <a href="#">Table 5.</a>, and note <a href="#">4.</a> below <a href="#">Table 6</a> (replaced “Maximum values include unavoidable inaccuracies of the industrial tests.” by “Maximum values are guaranteed by design.”).</li> <li>– Added <a href="#">Figure 34</a> to <a href="#">Figure 43</a>.</li> </ul> <p>Minor modifications throughout document.</p>

**Please Read Carefully:**

Information in this document is provided solely in connection with ST products. STMicroelectronics NV and its subsidiaries ("ST") reserve the right to make changes, corrections, modifications or improvements, to this document, and the products and services described herein at any time, without notice.

All ST products are sold pursuant to ST's terms and conditions of sale.

Purchasers are solely responsible for the choice, selection and use of the ST products and services described herein, and ST assumes no liability whatsoever relating to the choice, selection or use of the ST products and services described herein.

No license, express or implied, by estoppel or otherwise, to any intellectual property rights is granted under this document. If any part of this document refers to any third party products or services it shall not be deemed a license grant by ST for the use of such third party products or services, or any intellectual property contained therein or considered as a warranty covering the use in any manner whatsoever of such third party products or services or any intellectual property contained therein.

**UNLESS OTHERWISE SET FORTH IN ST'S TERMS AND CONDITIONS OF SALE ST DISCLAIMS ANY EXPRESS OR IMPLIED WARRANTY WITH RESPECT TO THE USE AND/OR SALE OF ST PRODUCTS INCLUDING WITHOUT LIMITATION IMPLIED WARRANTIES OF MERCHANTABILITY, FITNESS FOR A PARTICULAR PURPOSE (AND THEIR EQUIVALENTS UNDER THE LAWS OF ANY JURISDICTION), OR INFRINGEMENT OF ANY PATENT, COPYRIGHT OR OTHER INTELLECTUAL PROPERTY RIGHT.**

**ST PRODUCTS ARE NOT DESIGNED OR AUTHORIZED FOR USE IN: (A) SAFETY CRITICAL APPLICATIONS SUCH AS LIFE SUPPORTING, ACTIVE IMPLANTED DEVICES OR SYSTEMS WITH PRODUCT FUNCTIONAL SAFETY REQUIREMENTS; (B) AERONAUTIC APPLICATIONS; (C) AUTOMOTIVE APPLICATIONS OR ENVIRONMENTS, AND/OR (D) AEROSPACE APPLICATIONS OR ENVIRONMENTS. WHERE ST PRODUCTS ARE NOT DESIGNED FOR SUCH USE, THE PURCHASER SHALL USE PRODUCTS AT PURCHASER'S SOLE RISK, EVEN IF ST HAS BEEN INFORMED IN WRITING OF SUCH USAGE, UNLESS A PRODUCT IS EXPRESSLY DESIGNATED BY ST AS BEING INTENDED FOR "AUTOMOTIVE, AUTOMOTIVE SAFETY OR MEDICAL" INDUSTRY DOMAINS ACCORDING TO ST PRODUCT DESIGN SPECIFICATIONS. PRODUCTS FORMALLY ESCC, QML OR JAN QUALIFIED ARE DEEMED SUITABLE FOR USE IN AEROSPACE BY THE CORRESPONDING GOVERNMENTAL AGENCY.**

Resale of ST products with provisions different from the statements and/or technical features set forth in this document shall immediately void any warranty granted by ST for the ST product or service described herein and shall not create or extend in any manner whatsoever, any liability of ST.

ST and the ST logo are trademarks or registered trademarks of ST in various countries.

Information in this document supersedes and replaces all information previously supplied.

The ST logo is a registered trademark of STMicroelectronics. All other names are the property of their respective owners.

© 2013 STMicroelectronics - All rights reserved

STMicroelectronics group of companies

Australia - Belgium - Brazil - Canada - China - Czech Republic - Finland - France - Germany - Hong Kong - India - Israel - Italy - Japan - Malaysia - Malta - Morocco - Philippines - Singapore - Spain - Sweden - Switzerland - United Kingdom - United States of America

[www.st.com](http://www.st.com)



# Mouser Electronics

Authorized Distributor

Click to View Pricing, Inventory, Delivery & Lifecycle Information:

[STMicroelectronics:](#)

[TS881ICT](#) [TS881ILT](#)