

FIG 2
-LC: LOCKING CLIP
(DIFFERENT AS SHOWN, OTHERWISE SAME AS FIG 1)

TABLE 3			
	"A"	BODY	MIN NO OF POS
MOLDED	.100[2.54] REF	RTSM-50-DVU-XX	2
*STAKED	.100[2.54]	RTSM-50-DVU-XX	5

* = USE TWO SM-AHS

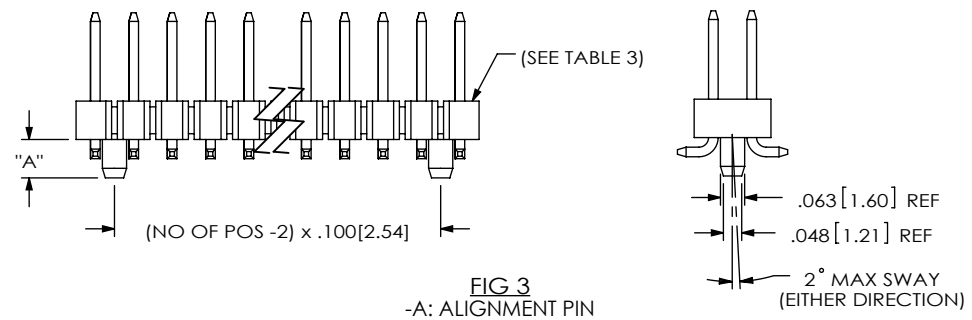

FIG 3
-A: ALIGNMENT PIN
(DIFFERENT AS SHOWN, OTHERWISE SAME AS FIG 1)

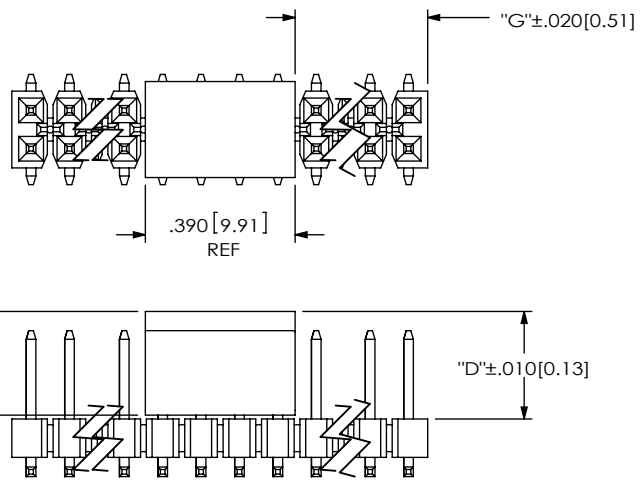

FIG 4
-P: PICK AND PLACE PAD
(DIFFERENT AS SHOWN, OTHERWISE SAME AS FIG 1)

"G" = ((NO OF POS x .100[2.54]) - .390[9.91])/2

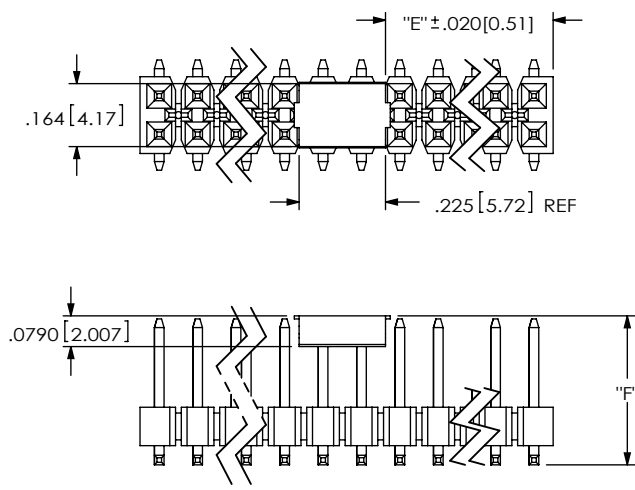

FIG 5
-M: METAL PICK AND PLACE PAD
(DIFFERENT AS SHOWN, OTHERWISE SAME AS FIG 1)
"E" = ((NO OF POS x .100[2.54]) - .225[5.72]) / 2

NOTE:
HAND FILL USE LMP-01
MACHINE FILL USE LMP-01

TABLE 2	
LEAD STYLE	"F"
-01	0.388[9.86]
-04	0.278[7.06]

PROPRIETARY NOTE
THIS DOCUMENT CONTAINS CONFIDENTIAL AND PROPRIETARY INFORMATION AND ALL DESIGN, MANUFACTURING, REPRODUCTION, USE, PATENT RIGHTS AND SALES RIGHTS ARE EXPRESSLY RESERVED BY SAMTEC, INC. THIS DOCUMENT SHALL NOT BE DISCLOSED, IN WHOLE OR PART, TO ANY UNAUTHORIZED PERSON OR ENTITY NOR REPRODUCED, TRANSFERRED OR INCORPORATED IN ANY OTHER PROJECT IN ANY MANNER WITHOUT THE EXPRESS WRITTEN CONSENT OF SAMTEC, INC.

DO NOT SCALE DRAWING
SHEET SCALE: 2:1

samtec
520 PARK EAST BLVD, NEW ALBANY, IN 47150
PHONE: 812-944-6733 FAX: 812-948-5047
e-Mail info@SAMTEC.com code 55322

DESCRIPTION:
DOUBLE ROW GULLWING ASM
DWG. NO.
TSM-1XX-XX-XXX-XX-X-XXX-X
BY: BRYANT 04/24/1991 SHEET 2 OF 3

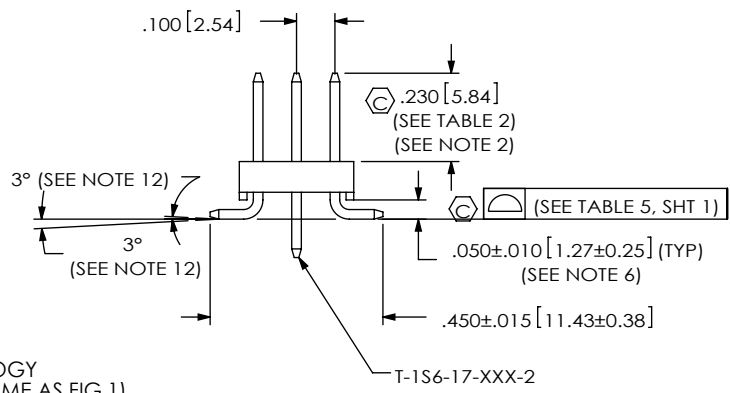
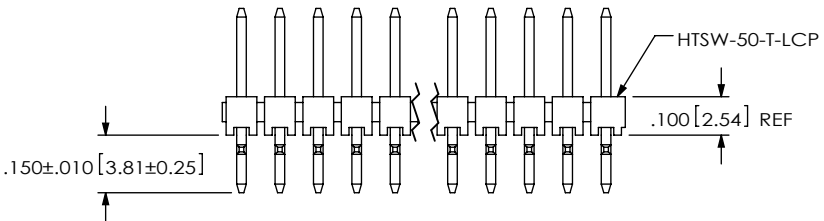
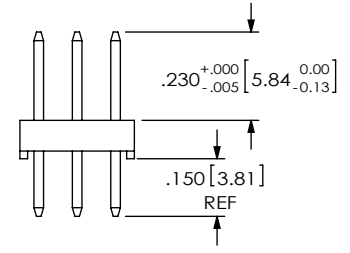

FIG 6
-TM: TRIPLE MIXED TECHNOLOGY
(DIFFERENT AS SHOWN, OTHERWISE SAME AS FIG 1)



IN-PROCESS
-TM MOUNT STYLE

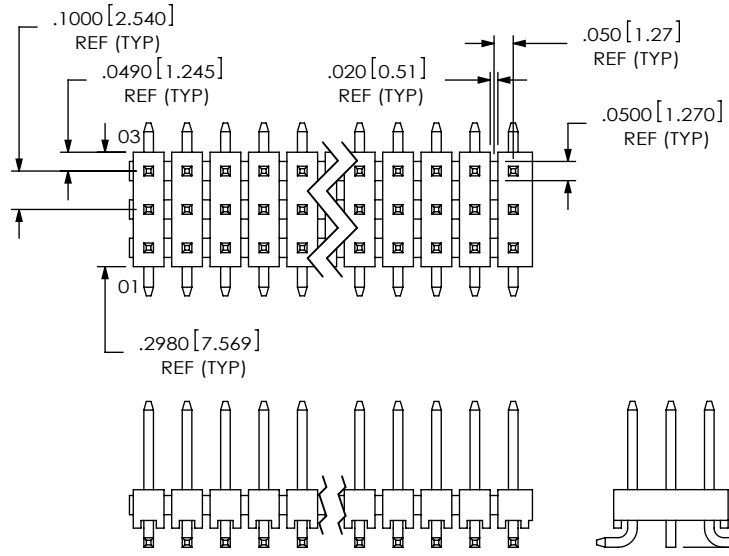

FIG 7
-TV: TRIPLE VERTICAL
(DIFFERENT AS SHOWN, OTHERWISE SAME AS FIG 6)
FOR EXISTING CUSTOMERS ONLY

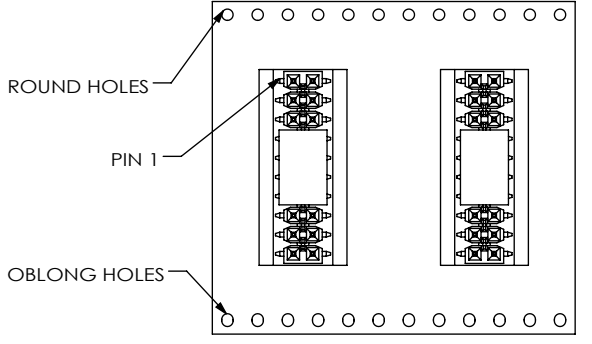
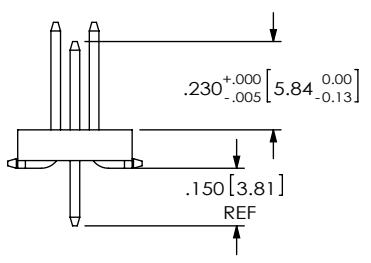
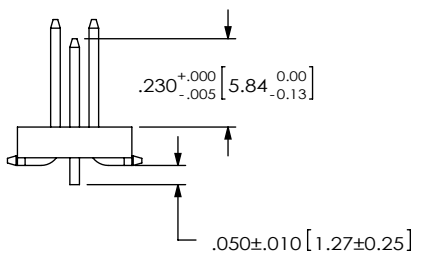

FIG 8
PACKAGING VIEWS

LEAD STYLE	MOUNT STYLE	OPTION	TUBE	PLUG	NOTE
01, 02, 04, 05	-DV	NONE	PT-1-24-01-29	TP-03	4
01, 02	-DV	-LC, -A	PT-1-24-01-29	TP-03	4
01, 04, 05	-DV	-P	PT-1-24-06-29	TP-03	4
01, 04, 05	-DV	-LC-P, -A-P	PT-1-24-06-29	TP-03	4
02	-DV	-P	PT-1-24-15-29	TP-07	4
02	-DV	-LC-P, -A-P	PT-1-24-15-29	TP-07	4
03	-DV	NONE	PT-1-24-09-29	TP-03	4
03	-DV	-LC, -A	PT-1-24-09-29	TP-03	4
03	-DV	-P	PT-1-24-16-29	TP-03	4
03	-DV	-LC-P, -A-P	PT-1-24-16-29	TP-03	4
04, 05	-DV	-LC, -A	PT-1-24-03-15	TP-03	4
01, 04, 05	-DV	-M, -LC-M, -A-M, -LC-A-M	PT-TSM004-DV	TP-03	4
01	-TM	NONE	PT-1-24-02-08	TP-13	4
01	-TV	NONE	PT-1-24-01-70	TP-07	4



IN-PROCESS 1
-TV MOUNT STYLE



IN-PROCESS 2
-TV MOUNT STYLE

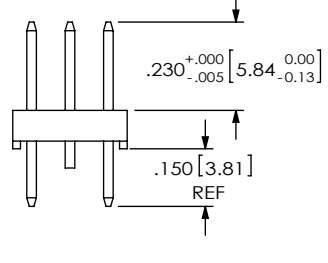

IN-PROCESS 3
-TV MOUNT STYLE

PROPRIETARY NOTE
THIS DOCUMENT CONTAINS CONFIDENTIAL AND PROPRIETARY INFORMATION AND ALL DESIGN, MANUFACTURING, REPRODUCTION, USE, PATENT RIGHTS AND SALES RIGHTS ARE EXPRESSLY RESERVED BY SAMTEC, INC. THIS DOCUMENT SHALL NOT BE DISCLOSED, IN WHOLE OR PART, TO ANY UNAUTHORIZED PERSON OR ENTITY NOR REPRODUCED, TRANSFERRED OR INCORPORATED IN ANY OTHER PROJECT IN ANY MANNER WITHOUT THE EXPRESS WRITTEN CONSENT OF SAMTEC, INC.

DO NOT SCALE DRAWING
SHEET SCALE: 2:1



520 PARK EAST BLVD, NEW ALBANY, IN 47150
PHONE: 812-944-6733 FAX: 812-948-5047
e-Mail info@SAMTEC.com code 55322

DESCRIPTION: **DOUBLE ROW GULLWING ASM**
DWG. NO. **TSM-1XX-XX-XXX-XX-X-XXX-X**
BY: BRYANT 04/24/1991 SHEET 3 OF 3

Mouser Electronics

Authorized Distributor

Click to View Pricing, Inventory, Delivery & Lifecycle Information:

Samtec:

[TSM-104-01-L-DV-M-TR](#) [TSM-108-01-L-DV-M-TR](#) [TSM-110-04-LM-DV](#) [TSM-112-03-TM-DV](#) [TSM-104-04-LM-DV-P](#)
[TSM-116-02-G-DV](#) [TSM-123-01-L-DV-LC-P-TR](#) [TSM-107-01-L-DV-001](#) [TSM-125-02-G-DV](#) [TSM-104-04-G-DV](#)
[TSM-107-04-S-DV-006-P](#) [TSM-103-02-L-DV-A-001](#) [TSM-110-02-F-DV-P](#) [TSM-125-01-H-DV-A](#) [TSM-105-04-F-DV-P](#)
[TSM-107-01-T-DV-LC-006-P-TR](#) [TSM-119-01-G-DV](#) [TSM-107-04-S-DV-006](#) [TSM-111-03-H-DV](#) [TSM-115-03-G-DV](#)
[TSM-108-04-T-DV-A-P](#) [TSM-110-02-L-DV-001](#) [TSM-115-01-G-DV](#) [TSM-103-04-LM-DV](#) [TSM-105-01-S-DV-A-001](#)
[TSM-113-05-T-DV](#) [TSM-140-02-S-DV](#) [TSM-104-02-F-DV-P](#) [TSM-113-02-T-DV-A-P](#) [TSM-112-01-F-DV-A-P](#) [TSM-105-04-S-DV-010-P](#) [TSM-107-02-F-DV-P](#) [TSM-116-01-F-DV-P](#) [TSM-117-04-S-DV-A-P](#) [TSM-148-01-F-DV](#) [TSM-150-02-F-DV](#) [TSM-107-04-F-DV-P](#) [TSM-107-01-F-DV-006-P](#) [TSM-108-02-G-DV-P](#) [TSM-110-02-F-DV-A-P](#) [TSM-119-01-T-DV-004](#) [TSM-104-01-S-DV-007-P](#) [TSM-110-04-H-DV](#) [TSM-111-01-G-DV](#) [TSM-112-01-LM-TM](#) [TSM-124-02-G-DV](#) [TSM-105-01-S-DV-010-P](#) [TSM-105-01-S-DV-A-008-P](#) [TSM-110-02-H-DV](#) [TSM-137-01-S-DV](#) [TSM-140-03-L-DV](#) [TSM-105-03-F-DV-P](#) [TSM-103-01-F-DV-LC](#) [TSM-122-01-LM-TM](#) [TSM-150-03-F-DV](#) [TSM-104-01-F-DV-A-P](#) [TSM-115-01-F-DV-A-P](#)