

## Functional Diagram

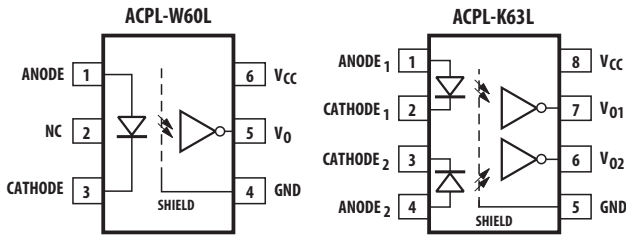

TRUTH TABLE  
(POSITIVE LOGIC)

LED	OUTPUT
ON	L
OFF	H

A 0.1- $\mu$ F bypass capacitor must be connected between pins 4 and 6 for ACPL-W60L, and pins 5 and 8 for ACPL-K63L.

## Schematic Diagrams

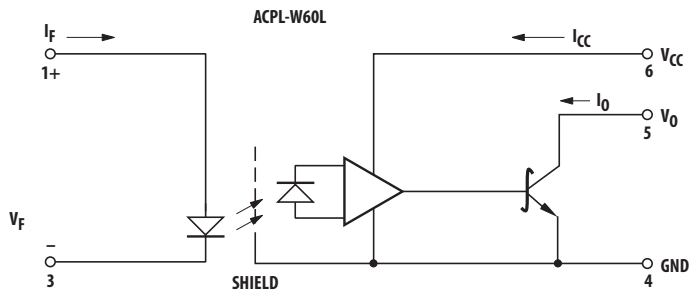

Bypassing of the power supply line is required, with a 0.1- $\mu$ F ceramic disc capacitor adjacent to each optocoupler. Total lead length between both ends of the capacitor and the isolator pins should not exceed 20 mm.

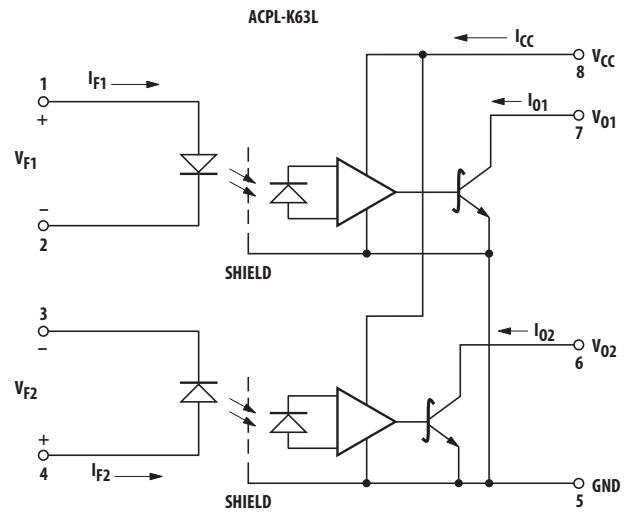

These optocouplers are suitable for high-speed logic interfacing, input/output buffering, as line receivers in environments that conventional line receivers cannot tolerate and are recommended for use in extremely high ground or induced noise environments.

## Ordering Information

ACPL-W60L/-K63L is UL Recognized with 5000 V<sub>rms</sub> for 1 minute per UL1577 and is approved under CSA Component Acceptance Notice #5, File CA 88324.

Part Number	Option	Package	Surface Mount	Tape and Reel	UL 5000 Vrms/ 1 Minute rating	IEC/EN/DIN EN 60747-5-5	Quantity
	RoHS Compliant						
ACPL-W60L	-000E	Stretched SO-6	X		X		100 per tube
	-500E		X	X	X		1000 per reel
	-560E		X	X	X	X	1000 per reel
ACPL-K63L	-000E	Stretched SO-8	X		X		80 per tube
	-500E		X	X	X		1000 per reel
	-560E		X	X	X	X	1000 per reel

To order, choose a part number from the part number column and combine with the desired option from the option column to form an order entry.

Example 1:

ACPL-W60L-560E to order product of Stretched SO-6 Surface Mount package in Tape and Reel packaging with IEC/EN/DIN EN 60747-5-5 Safety Approval in RoHS compliant.

Option data sheets are available. Contact your Broadcom sales representative or authorized distributor for information.

# Package Outline Drawings

## ACPL-W60L Stretched SO-6 Package

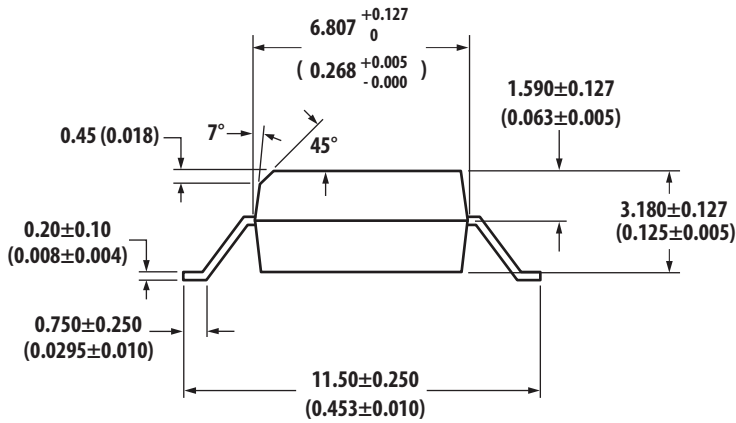
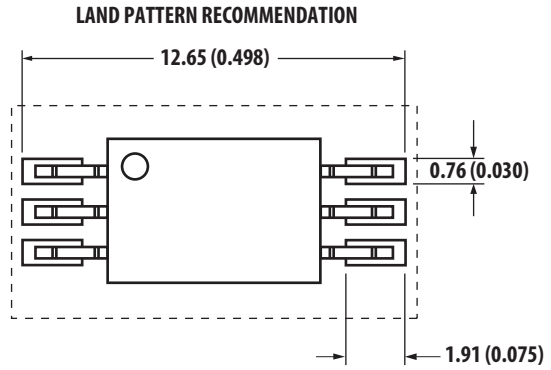
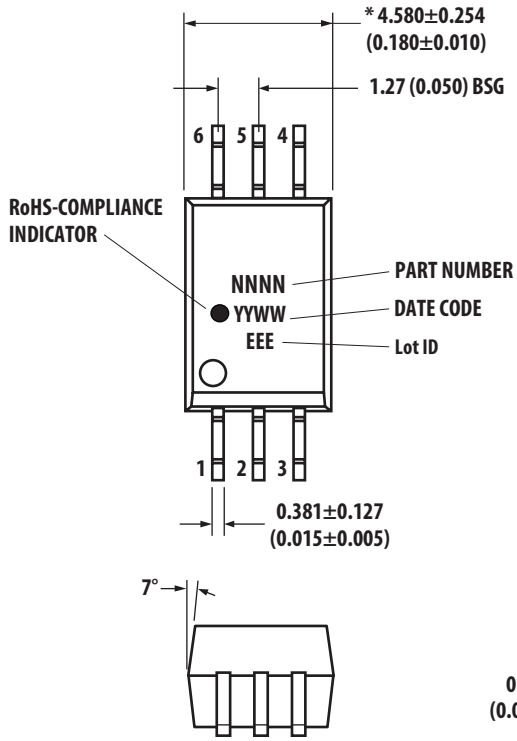

\* Total package width (inclusive of mold flash)  
 $4.834 \pm 0.254$  mm  
 Dimensions in Millimeters (Inches).  
 Lead coplanarity =  $0.1$  mm ( $0.004$  inches).

## ACPL-K63L Stretched SO-8 Package

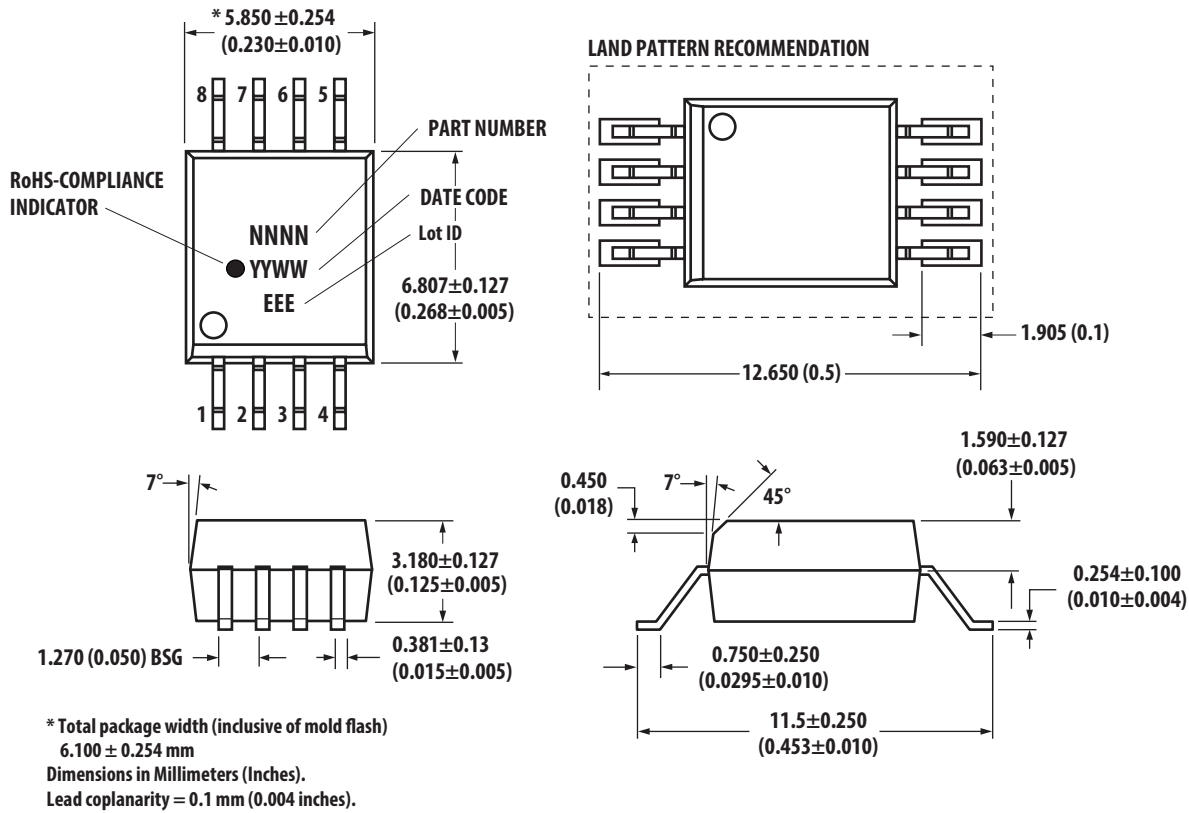

## Recommended Solder Reflow Thermal Profile

Recommended reflow condition as per JEDEC Standard, J-STD-020 (latest revision). Non-halide flux should be used.

## Regulatory Information

The ACPL-W60L/K63L have been approved by the following organizations.

<b>UL</b>	Approval under UL 1577, Component Recognition Program, File E55361.
<b>CSA</b>	Approval under CSA Component Acceptance Notice #5, File CA 88324.
<b>IEC/EN/DIN EN 60747-5-5</b>	Approval/Pending Approval

## Insulation and Safety-Related Specifications

Parameter	Symbol	ACPL-W60L/ K63L	Units	Conditions
Minimum External Air Gap (External Clearance)	L (101)	8	mm	Measured from input terminals to output terminals, shortest distance through air.
Minimum External Tracking (External Creepage)	L (102)	8	mm	Measured from input terminals to output terminals, shortest distance path along body.
Minimum Internal Plastic Gap (Internal Clearance)		0.08	mm	Through insulation distance, conductor to conductor, usually the direct distance between the photoemitter and photodetector inside the optocoupler cavity.
Tracking Resistance (Comparative Tracking Index)	CTI	175	Volts	DIN IEC 112/VDE 0303 Part 1
Isolation Group		IIIa	—	Material Group (DIN VDE 0110, 1/89, Table 1)

## IEC/EN/DIN EN 60747-5-5 Insulation-Related Characteristics (Option x60E)

Description	Symbol	Characteristic ACPL-W60L ACPL-K63L	Units
Installation classification per DIN VDE 0110/39, Table 1			
for rated mains voltage $\leq 150 V_{rms}$		I-IV	
for rated mains voltage $\leq 300 V_{rms}$		I-IV	
for rated mains voltage $\leq 600 V_{rms}$		I-III	
for rated mains voltage $\leq 1000 V_{rms}$		I-III	
Climatic Classification		55/100/21	
Pollution Degree (DIN VDE 0110/39)		2	
Maximum Working Insulation Voltage	$V_{IORM}$	1140	$V_{peak}$
Input to Output Test Voltage, Method b <sup>a</sup> $V_{IORM} \times 1.875 = V_{PR}$ , 100% Production Test with $t_m = 1s$ , Partial Discharge $< 5 pC$	$V_{PR}$	2137	$V_{peak}$
Input-to-Output Test Voltage, Method a <sup>a</sup> $V_{IORM} \times 1.6 = V_{PR}$ , Type and Sample Test, $t_m = 10s$ , Partial Discharge $< 5 pC$	$V_{PR}$	1824	$V_{peak}$
Highest Allowable Overvoltage (Transient Overvoltage, $t_{ini} = 60s$ )	$V_{IOTM}$	8000	$V_{peak}$
Safety Limiting Values – maximum values allowed in the event of a failure			
Case Temperature	$T_S$	175	$^{\circ}C$
Input Current	$I_{S,INPUT}$	230	mA
Output Power	$P_{S,OUTPUT}$	600	mW
Insulation Resistance at $T_S$ , $V_{IO} = 500 V$	$R_S$	$\geq 10^9$	$\Omega$

- a. Refer to the optocoupler section of the Isolation and Control Components Designer's Catalog, under Product Safety Regulations section, (IEC/EN/DIN EN 60747-5-5) for a detailed description of Method a and Method b partial discharge test profiles.

**NOTE** These optocouplers are suitable for "safe electrical isolation" only within the safety limit data. Maintenance of the safety limit data shall be ensured by means of protective circuits.

## Absolute Maximum Ratings (No Derating Required Up to 85°C)

Parameter	Symbol	Device <sup>a</sup>	Min.	Max.	Units	Note
Storage Temperature	$T_S$		-55	125	°C	
Operating Temperature†	$T_A$		-40	100	°C	
Average Forward Input Current	$I_F$	ACPL-W60L	—	20	mA	b
		ACPL-K63L	—	15		c, d
Reverse Input Voltage	$V_R$		—	5	V	c
Input Power Dissipation	$P_I$		—	40	mW	
Supply Voltage (1 Minute Maximum)	$V_{CC}$		—	7	V	
Output Collector Current	$I_O$		—	50	mA	c
Output Collector Voltage	$V_O$		—	7	V	c
Output Power Dissipation	$P_O$	ACPL-W60L	—	85	mW	
		ACPL-K63L	—	60		c, e
Solder Reflow Temperature Profile			See <a href="#">Package Outline Drawings</a>			

- Ratings apply to all devices except otherwise noted in the Package column.
- Peaking circuits may produce transient input currents up to 50 mA, 50-ns maximum pulse width, provided average current does not exceed 20 mA.
- Each channel.
- Peaking circuits may produce transient input currents up to 50 mA, 50-ns maximum pulse width, provided average current does not exceed 15 mA.
- Derate linearly above +80°C free-air temperature at a rate of 2.7 mW/°C.

## Recommended Operating Conditions

Parameter	Symbol	Min.	Max.	Units	Conditions
Input Current, Low Level	$I_{FL}$ <sup>a</sup>	0	250	μA	
Input Current, High Level <sup>b</sup>	$I_{FH}$ <sup>c</sup>	5	15	mA	$2.7V \leq V_{CC} \leq 3.6V$ , $T_A = 85^\circ C$ to $100^\circ C$
		6		mA	
Power Supply Voltage	$V_{CC}$	2.7	3.6	V	
		4.5	5.5	V	
Operating Temperature	$T_A$	-40	100	°C	
Fan Out (at $R_L = 1\text{ k}\Omega$ ) <sup>b</sup>	N	—	5	TTL Loads	
Output Pull-up Resistor	$R_L$	330	4 k	Ω	

- The off condition can also be guaranteed by ensuring that  $V_{FL} \leq 0.8$  volts.
- Each channel.
- At  $T_A = -40^\circ C$  to  $85^\circ C$ . The initial switching threshold is 5 mA or less. It is recommended that 6.3 mA to 10 mA be used for best performance and to permit at least a 20% LED degradation guardband.

## Electrical Specifications

Over recommended operating conditions ( $T_A = -40^\circ\text{C}$  to  $+100^\circ\text{C}$ ,  $2.7\text{V} \leq V_{CC} \leq 3.6\text{V}$ ) unless otherwise specified.  
All Typical at  $V_{CC} = 3.3\text{V}$ ,  $T_A = 25^\circ\text{C}$ .

Parameter	Symbol	Device	Min.	Typ.	Max.	Units	Test Conditions	Figure	Note
High Level Output Current	$I_{OH}$		—	4.5	50	$\mu\text{A}$	$V_{CC} = 3.3\text{V}$ , $V_O = 3.3\text{V}$ , $I_F = 250 \mu\text{A}$	1, 2	a
Input Threshold Current	$I_{TH}$		—	3.0	5.0	mA	$T_A = -40^\circ\text{C}$ to $85^\circ\text{C}$ , $V_{CC} = 3.3\text{V}$ , $V_O = 0.6\text{V}$ , $I_{OL}$ (Sinking) = 13 mA	3, 4	
					6.0	mA	$V_{CC} = 3.3\text{V}$ , $V_O = 0.6\text{V}$ , $I_{OL}$ (Sinking) = 13 mA	3, 4	
Low Level Output Voltage	$V_{OL}$		—	0.35	0.6	V	$V_{CC} = 3.3\text{V}$ , $I_F = 5\text{ mA}$ , $I_{OL}$ (Sinking) = 13 mA	5, 6	
High Level Supply Current	$I_{CCH}$	Single	—	4.7	7.0	mA	$I_F = 0\text{ mA}$		
		Dual	—	6.9	10.0		$V_{CC} = 3.3\text{V}$		
Low Level Supply Current	$I_{CCL}$	Single	—	7.0	10.0	mA	$I_F = 10\text{ mA}$		
		Dual	—	8.7	15.0		$V_{CC} = 3.3\text{V}$		
Input Forward Voltage	$V_F$		1.4	1.5	1.75	V	$T_A = 25^\circ\text{C}$ , $I_F = 10\text{ mA}$	9	a
Input Reverse Breakdown Voltage	$B_{VR}$		5	—	—	V	$I_R = 10 \mu\text{A}$		a
Input Diode Temperature Coefficient	$\Delta V_F / \Delta T_A$		—	-1.6	—	mV/°C	$I_F = 10\text{ mA}$		a
Input Capacitance	$C_{IN}$		—	60	—	pF	$f = 1\text{ MHz}$ , $V_F = 0\text{V}$		a

a. Each channel.

## Electrical Specifications (DC)

Over recommended operating conditions ( $T_A = -40^\circ\text{C}$  to  $+100^\circ\text{C}$ ,  $4.5\text{V} \leq V_{DD} \leq 5.5\text{V}$ ) unless otherwise specified.  
All typicals at  $V_{CC} = 5\text{V}$ ,  $T_A = 25^\circ\text{C}$ .

Parameter	Symbol	Device	Min.	Typ.	Max.	Units	Test Conditions	Figure	Note
High Level Output Current	$I_{OH}$		—	5.5	100	$\mu\text{A}$	$V_{CC} = 5.5\text{V}$ , $V_O = 5.5\text{V}$ , $I_{FL} = 250\ \mu\text{A}$	1, 2	a
Input Threshold Current	$I_{TH}$		—	2.0	5.0	$\text{mA}$	$V_{CC} = 5.5\text{V}$ , $V_O = 0.6\text{V}$ , $I_{OL} > 13\ \text{mA}$	3, 4	
Low Level Output Voltage	$V_{OL}$		—	0.35	0.6	$\text{V}$	$V_{CC} = 5.5\text{V}$ , $I_F = 5\ \text{mA}$ , $I_{OL(\text{Sinking})} = 13\ \text{mA}$	5, 6	
High Level Supply Current	$I_{CCH}$	Single	—	7.0	10.0	$\text{mA}$	$V_{CC} = 5.5\text{V}$ , $I_F = 0\ \text{mA}$		
		Dual	—	10.0	15.0	$\text{mA}$	$V_{CC} = 5.5\text{V}$ , $I_F = 0\ \text{mA}$		
Low Level Supply Current	$I_{CCL}$	Single	—	9.0	13.0	$\text{mA}$	$V_{CC} = 5.5\text{V}$ , $I_F = 10\ \text{mA}$		
		Dual	—	13.0	21.0	$\text{mA}$	$V_{CC} = 5.5\text{V}$ , $I_F = 10\ \text{mA}$		
Input Forward Voltage	$V_F$		1.4	1.5	1.75	$\text{V}$	$T_A = 25^\circ\text{C}$ , $I_F = 10\ \text{mA}$	9	a
			1.3	—	1.8				
Input Reverse Breakdown Voltage	$BV_R$		5	—	—	$\text{V}$	$I_R = 10\ \mu\text{A}$		a
Input Diode Temperature Coefficient	$\Delta V_F / \Delta T_A$		—	-1.6	—	$\text{mV}/^\circ\text{C}$	$I_F = 10\ \text{mA}$		a
Input Capacitance	$C_{IN}$		—	60	—	$\text{pF}$	$f = 1\ \text{MHz}$ , $V_F = 0\ \text{V}$		a

a. Each channel.



## Switching Specifications

Over recommended temperature ( $T_A = -40^\circ\text{C}$  to  $+100^\circ\text{C}$ ),  $V_{CC} = 3.3\text{V}$ ,  $I_F = 7.5\text{ mA}$  unless otherwise specified.  
All Typical at  $T_A = 25^\circ\text{C}$ ,  $V_{CC} = 3.3\text{V}$ .

Parameter	Symbol	Min.	Typ.	Max.	Units	Test Conditions	Figure	Note
Propagation Delay Time to High Output Level	$t_{PLH}$	—	—	90	ns	$T_A = -40^\circ\text{C}$ to $85^\circ\text{C}$ , $R_L = 350\Omega$ , $C_L = 15\text{ pF}$	10, 11, 12, 13, 14	a, b
		—	—	95	ns	$R_L = 350\Omega$ , $C_L = 15\text{ pF}$		
Propagation Delay Time to Low Output Level	$t_{PHL}$	—	—	75	ns	$T_A = -40^\circ\text{C}$ to $85^\circ\text{C}$ , $R_L = 350\Omega$ , $C_L = 15\text{ pF}$		a, c
		—	—	90	ns	$R_L = 350\Omega$ , $C_L = 15\text{ pF}$		
Pulse Width Distortion	$ t_{PHL} - t_{PLH} $	—	—	25	ns	$T_A = -40^\circ\text{C}$ to $85^\circ\text{C}$ , $R_L = 350\Omega$ , $C_L = 15\text{ pF}$	13, 14	d
		—	—	30	ns	$R_L = 350\Omega$ , $C_L = 15\text{ pF}$		
Propagation Delay Skew	$t_{PSK}$	—	—	40	ns			d, e
Output Rise Time (10–90%)	$t_r$	—	45	—	ns			a
Output Fall Time (90–10%)	$t_f$	—	20	—	ns			a

- Each channel.
- The  $t_{PLH}$  propagation delay is measured from the 3.75 mA point on the falling edge of the input pulse to the 1.5-V point on the rising edge of the output pulse.
- The  $t_{PHL}$  propagation delay is measured from the 3.75 mA point on the rising edge of the input pulse to the 1.5-V point on the falling edge of the output pulse.
- See test circuit for measurement details.
- $t_{PSK}$  is equal to the worst case difference in  $t_{PHL}$  and/or  $t_{PLH}$  that will be seen between units at any given temperature and specified test conditions.

## Switching Specifications (AC)

Over recommended temperature ( $T_A = -40^\circ\text{C}$  to  $+100^\circ\text{C}$ ),  $V_{CC} = 5\text{V}$ ,  $I_F = 7.5\text{ mA}$  unless otherwise specified.  
All Typical at  $T_A = 25^\circ\text{C}$ ,  $V_{CC} = 5\text{V}$ .

Parameter	Symbol	Min.	Typ.	Max.	Units	Test Conditions	Figure	Note
Propagation Delay Time to High Output Level	$t_{PLH}$	20	48	75	ns	$T_A = 25^\circ\text{C}$ , $R_L = 350\Omega$ , $C_L = 15\text{ pF}$	10, 11, 12, 13, 14	a, b
		—	—	100	ns	$R_L = 350\Omega$ , $C_L = 15\text{ pF}$		
Propagation Delay Time to Low Output Level	$t_{PHL}$	25	50	75	ns	$T_A = 25^\circ\text{C}$ , $R_L = 350\Omega$ , $C_L = 15\text{ pF}$		a, c
		—	—	100	ns	$R_L = 350\Omega$ , $C_L = 15\text{ pF}$		
Pulse Width Distortion	$ t_{PHL} - t_{PLH} $	—	3.5	35	ns	$R_L = 350\Omega$ , $C_L = 15\text{ pF}$	13, 14	d
Propagation Delay Skew	$t_{psk}$	—	—	40	ns	$R_L = 350\Omega$ , $C_L = 15\text{ pF}$		d, e
Output Rise Time (10%-90%)	$t_r$	—	24	—	ns	$R_L = 350\Omega$ , $C_L = 15\text{ pF}$		a
Output Fall Time (10%-90%)	$t_f$	—	10	—	ns	$R_L = 350\Omega$ , $C_L = 15\text{ pF}$		a

- Each channel.
- The  $t_{PLH}$  propagation delay is measured from the 3.75 mA point on the falling edge of the input pulse to the 1.5-V point on the rising edge of the output pulse.
- The  $t_{PHL}$  propagation delay is measured from the 3.75 mA point on the rising edge of the input pulse to the 1.5-V point on the falling edge of the output pulse.
- See test circuit for measurement details.
- $t_{PSK}$  is equal to the worst case difference in  $t_{PHL}$  and/or  $t_{PLH}$  that will be seen between units at any given temperature and specified test conditions.

Parameter	Symbol	Min.	Typ.	Units	Test Conditions	Figure	Note
Output High Level Common Mode Transient Immunity	$ CM_H $	15	25	kV/ $\mu$ s	$V_{CC} = 3.3V, I_F = 0 \text{ mA}, V_{O(MIN)} = 2V, R_L = 350\Omega, T_A = 25^\circ\text{C}, V_{CM} = 1000V$ and $V_{CM} = 10V$	15	a, b
Output Low Level Common Mode Transient Immunity	$ CM_L $	15	25	kV/ $\mu$ s	$V_{CC} = 3.3V, I_F = 7.5 \text{ mA}, V_{O(MAX)} = 0.8V, R_L = 350\Omega, T_A = 25^\circ\text{C}, V_{CM} = 1000V$ and $V_{CM} = 10V$	15	a, b
Output High Level Common Mode Transient Immunity	$ CM_H $	10	15	kV/ $\mu$ s	$V_{CC} = 5V, I_F = 0 \text{ mA}, V_{O(MIN)} = 2V, R_L = 350\Omega, T_A = 25^\circ\text{C}, V_{CM} = 1000V$	15	a, b
Output Low Level Common Mode Transient Immunity	$ CM_L $	10	15	kV/ $\mu$ s	$V_{CC} = 5V, I_F = 7.5 \text{ mA}, V_{O(MAX)} = 0.8V, R_L = 350\Omega, T_A = 25^\circ\text{C}, V_{CM} = 1000V$	15	c, b

- a.  $CM_H$  is the maximum tolerable rate of rise on the common mode voltage to assure that the output will remain in a high logic state (that is,  $V_o > 2.0V$ ).
- b. For sinusoidal voltages,  $(|dV_{CM}| / dt)_{max} = \pi f_{CM} V_{CM} (p-p)$ .
- c.  $CM_L$  is the maximum tolerable rate of fall of the common mode voltage to assure that the output will remain in a low logic state (that is,  $V_o < 0.8V$ ).

## Package Characteristics

All Typicals at  $T_A = 25^\circ\text{C}$ .

Parameter	Symbol	Package	Min.	Typ.	Max	Units	Test Conditions	Figure	Note
Input-Output Insulation	$II_{O^a}$	Single	—	—	1	$\mu\text{A}$	45% RH, $t = 5s, V_{I-O} = 3 \text{ kV DC}, T_A = 25^\circ\text{C}$		b, c
Input-Output Momentary Withstand Voltage <sup>a</sup>	$V_{ISO}$	Single, Dual Channel	5000		—	Vrms	RH $\leq 50\%$ , $t = 1 \text{ min}, T_A = 25^\circ\text{C}$		b, c
Input-Output Resistance	$R_{I-O}$	Single, Dual Channel	—	$10^{12}$	—	$\Omega$	$V_{I-O} = 500 \text{ V}_{dc}$		b, d, e
Input-Output Capacitance	$C_{I-O}$	Single, Dual Channel	—	0.5	—	pF	$f = 1 \text{ MHz}, T_A = 25^\circ\text{C}$		b, d, e
Input-Input Insulation Leakage Current	$I_{I-I}$	Dual Channel	—	0.005	—	$\mu\text{A}$	RH $\leq 45\%$ , $t = 5s, V_{I-I} = 500V$		f
Resistance (Input-Input)	$R_{I-I}$	Dual Channel	—	$10^{11}$	—	$\Omega$			f
Capacitance (Input-Input)	$C_{I-I}$	Dual Channel	—	0.25	—	pG		$f = 1 \text{ MHz}$	

- a. The Input-Output Momentary Withstand Voltage is a dielectric voltage rating that should not be interpreted as an input-output continuous voltage rating. For the continuous voltage rating refer to the IEC/EN/DIN EN 60747-5-5 Insulation Characteristics Table (if applicable), your equipment level safety specification or Broadcom Application Note 1074 entitled *Optocoupler Input-Output Endurance Voltage*.
- b. Single channel device is considered a two-terminal part when pins 1, 2, 3 are shorted together, and pins 4, 5, 6 shorted together separately. Dual channel device is considered a two-terminal part when pins 1, 2, 3, 4 are shorted together, and pins 5, 6, 7, 8 are shorted together separately.
- c. In accordance with UL 1577, each optocoupler is proof tested by applying an insulation test voltage  $\geq 6000 V_{rms}$  for one second (leakage detection current limit,  $I_{I-O} \leq 5 \mu\text{A}$ ). This test is performed before the 100% production test for partial discharge (Method b) shown in the IEC/EN/DIN EN 60747-5-5 Insulation Characteristics Table, if applicable.
- d. Each channel.
- e. Measured between the LED anode and cathode shorted together and pins 5 through 8 shorted together. For dual channel products only.
- f. Measured between pins 1 and 2 shorted together, and pins 3 and 4 shorted together. For dual channel products only.

**Figure 1 Typical High Level Output Current vs. Temperature,  $V_{CC} = 3.3V$**

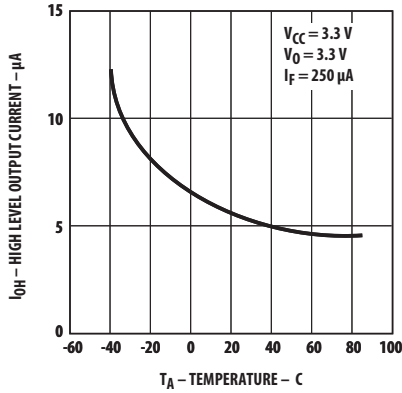

**Figure 2 Typical High Level Output Current vs. Temperature,  $V_{CC} = 5V$**

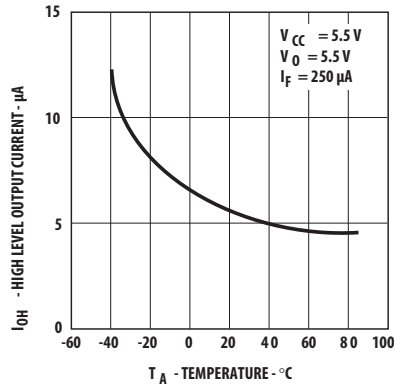

**Figure 3 Typical Input Threshold Current vs Temperature,  $V_{CC} = 3.3V$**

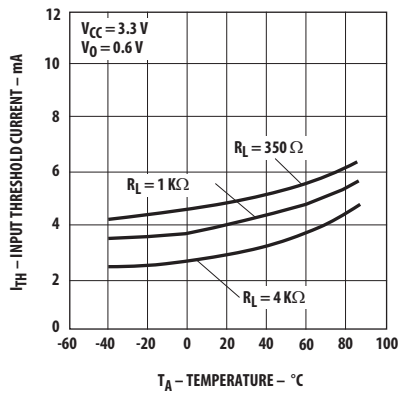

**Figure 4 Typical Input Threshold Current vs Temperature,  $V_{CC} = 5V$**

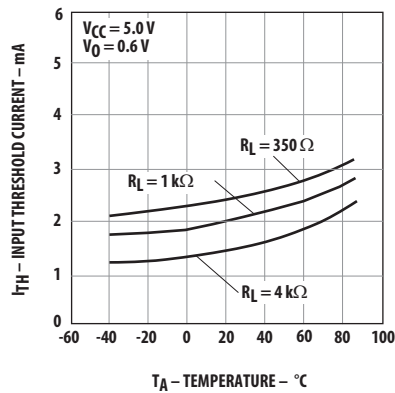

**Figure 5 Typical Low Level Output Voltage vs. Temperature,  $V_{CC} = 3.3V$**

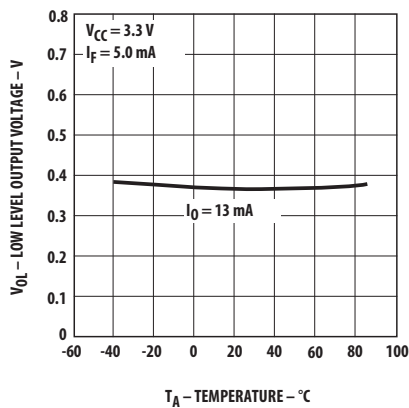

**Figure 6 Typical Low Level Output Voltage vs. Temperature,  $V_{CC} = 5V$**

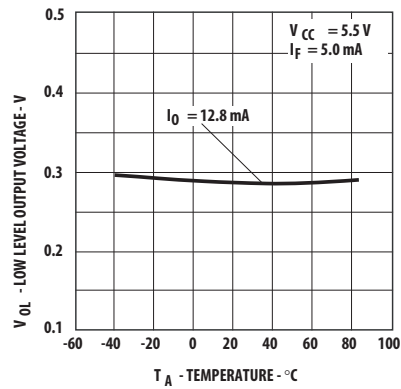

**Figure 7 Typical Low Level Output Current vs. Temperature,  $V_{CC} = 3.3V$**

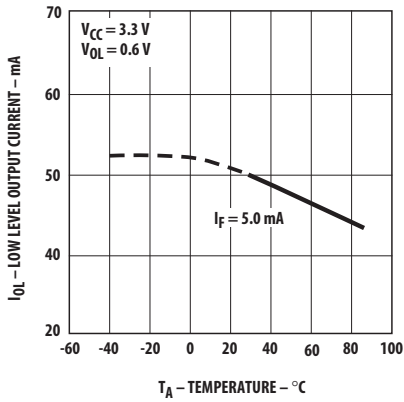

**Figure 8 Typical Low Level Output Current vs. Temperature,  $V_{CC} = 5V$**

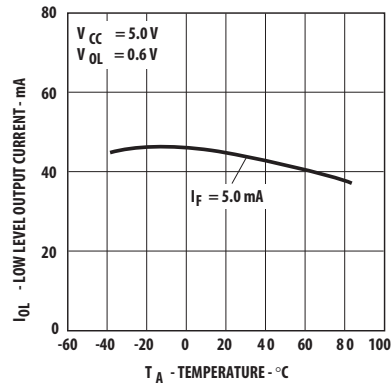

**Figure 9 Typical Input Diode Forward Characteristic**

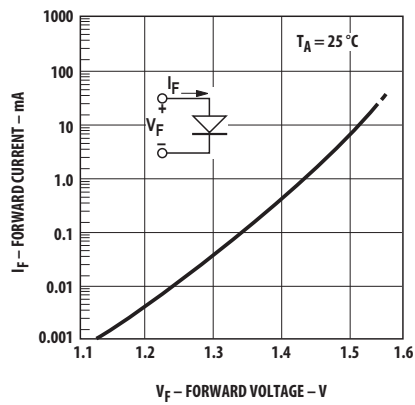
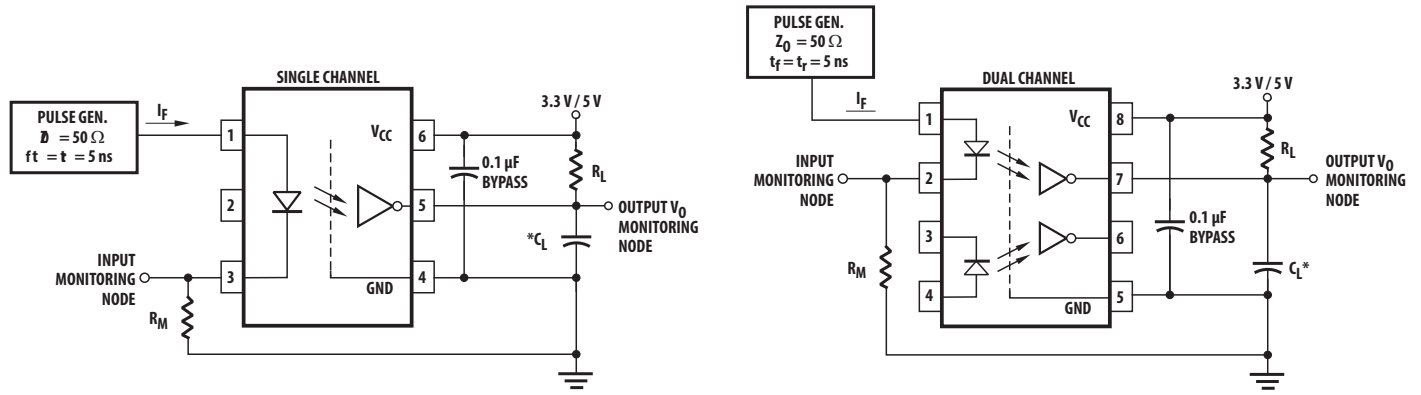

Figure 10 Test Circuit for  $t_{PHL}$  and  $t_{PLH}$



\* $C_L$  IS APPROXIMATELY 15 pF WHICH INCLUDES PROBE AND STRAY WIRING CAPACITANCE.

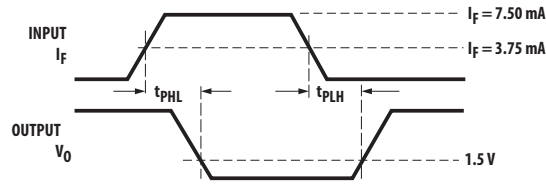

Figure 11 Typical Propagation Delay vs. Temperature  $V_{CC} = 3.3V$

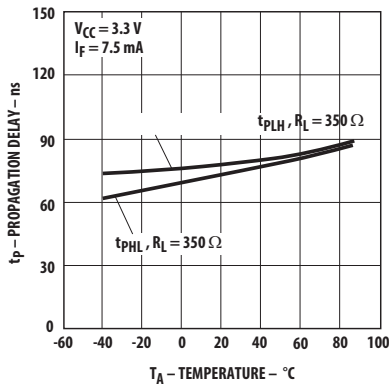
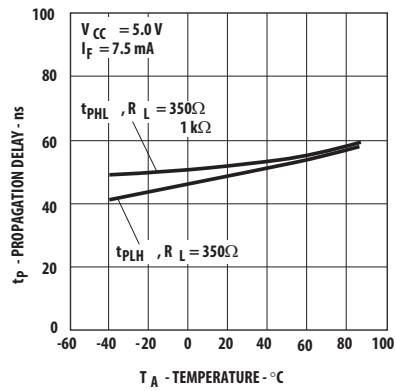
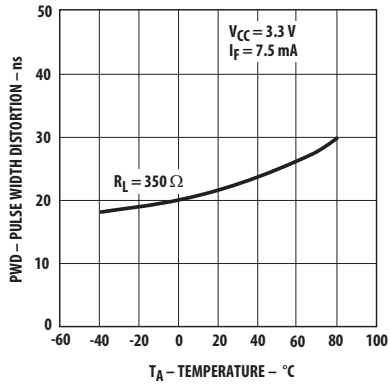

Figure 12 Typical Propagation Delay vs. Temperature  $V_{CC} = 5V$



**Figure 13 Typical Pulse Width Distortion vs. Temperature,  $V_{CC} = 3.3V$**



**Figure 14 Typical Pulse Width Distortion vs. Temperature,  $V_{CC} = 5V$**

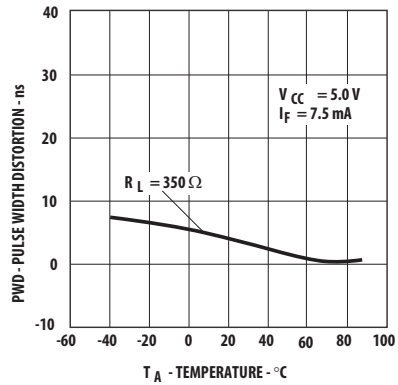

**Figure 15 Test Circuit for Common Mode Transient Immunity and Typical Waveforms**

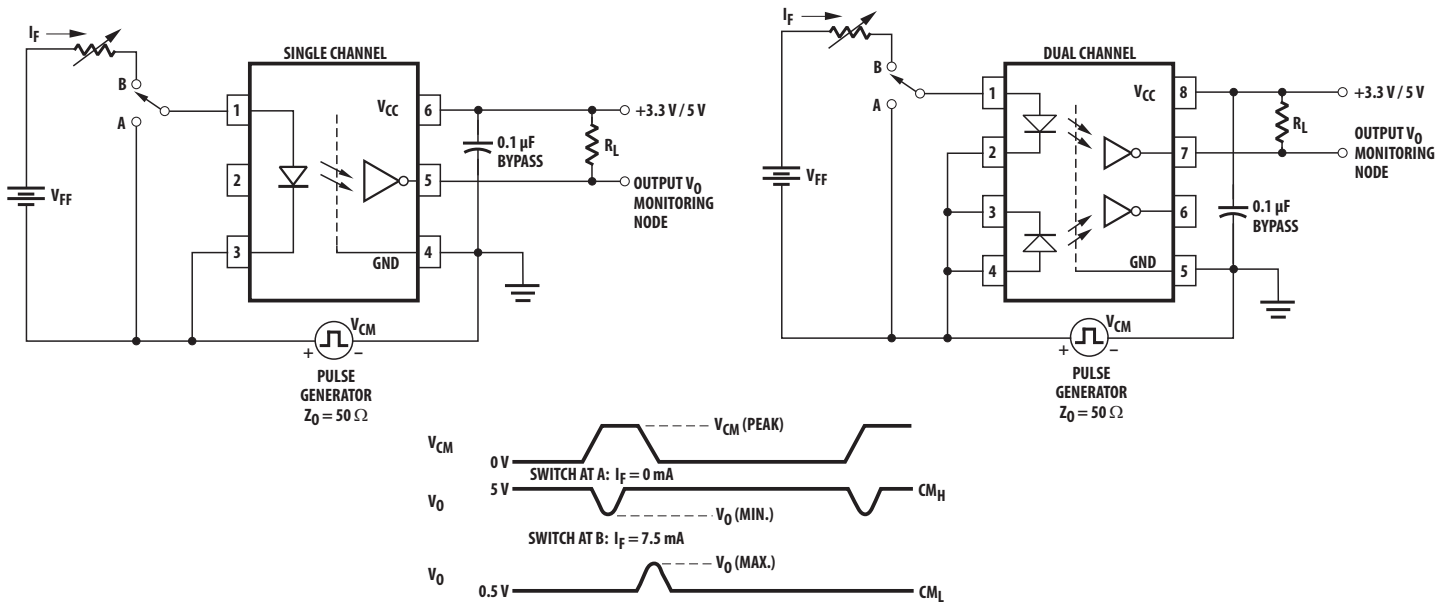

---

For product information and a complete list of distributors, please go to our web site: [www.broadcom.com](http://www.broadcom.com).

Broadcom, the pulse logo, Connecting everything, Avago Technologies, Avago, and the A logo are among the trademarks of Broadcom and/or its affiliates in the United States, certain other countries and/or the EU.

Copyright © 2013–2017 by Broadcom. All Rights Reserved.

The term "Broadcom" refers to Broadcom Limited and/or its subsidiaries. For more information, please visit [www.broadcom.com](http://www.broadcom.com).

Broadcom reserves the right to make changes without further notice to any products or data herein to improve reliability, function, or design.

Information furnished by Broadcom is believed to be accurate and reliable. However, Broadcom does not assume any liability arising out of the application or use of this information, nor the application or use of any product or circuit described herein, neither does it convey any license under its patent rights nor the rights of others.

AV02-0890EN – May 11, 2017



# Mouser Electronics

Authorized Distributor

Click to View Pricing, Inventory, Delivery & Lifecycle Information:

## Broadcom Limited:

[ACPL-K63L-000E](#) [ACPL-K63L-500E](#) [ACPL-W60L-000E](#) [ACPL-W60L-500E](#) [ACPL-W60L-560E](#) [ACPL-K63L-520E](#)  
[ACPL-K63L-560E](#)