

# Single/Dual/Quad, General-Purpose, Low-Voltage, Rail-to-Rail Output Op Amps

## ABSOLUTE MAXIMUM RATINGS

Supply Voltage (V <sub>CC</sub> to V <sub>EE</sub> )	-0.3V to +8V	8-Pin SO (derate 5.9mW/°C above +70°C)	471mW
Differential Input Voltage (V <sub>IN+</sub> - V <sub>IN-</sub> )	V <sub>EE</sub> to V <sub>CC</sub>	8-Pin μMAX (derate 4.5mW/°C above +70°C)	362mW
OUT <sub>-</sub> to V <sub>EE</sub>	-0.3V to (V <sub>CC</sub> + 0.3V)	14-Pin TSSOP (derate 9.1mW/°C above +70°C)	727mW
Output Short-Circuit Duration		14-Pin SO (derate 8.3mW/°C above +70°C)	667mW
OUT <sub>-</sub> Shorted to V <sub>CC</sub> or V <sub>EE</sub>	Continuous	Operating Temperature Range	-40°C to +125°C
Continuous Power Dissipation (T <sub>A</sub> = +70°C)		Junction Temperature	+150°C
5-Pin SC70-5 (derate 3.1mW/°C above +70°C)	247mW	Storage Temperature Range	-65°C to +150°C
5-Pin SOT23-5 (derate 7.1mW/°C above +70°C)	571mW	Lead Temperature (soldering, 10s)	+300°C
8-Pin SOT23-8 (derate 7.52mW/°C above +70°C)	602mW		

Stresses beyond those listed under "Absolute Maximum Ratings" may cause permanent damage to the device. These are stress ratings only, and functional operation of the device at these or any other conditions beyond those indicated in the operational sections of the specifications is not implied. Exposure to absolute maximum rating conditions for extended periods may affect device reliability.

## ELECTRICAL CHARACTERISTICS

(V<sub>CC</sub> = +2.7V, V<sub>EE</sub> = 0V, V<sub>OUT</sub> = V<sub>CC</sub>/2, V<sub>CM</sub> = 1V, R<sub>L</sub> > 1MΩ, T<sub>A</sub> = +25°C, unless otherwise noted.)

PARAMETER	SYMBOL	CONDITIONS	MIN	TYP	MAX	UNITS
<b>DC CHARACTERISTICS</b>						
Input Offset Voltage	V <sub>OS</sub>			1	6	mV
Input Offset Voltage Average Drift	TCV <sub>OS</sub>			6		μV/°C
Input Bias Current	I <sub>B</sub>			18	50	nA
Input Offset Current	I <sub>OS</sub>			1	8	nA
Common-Mode Rejection Ratio	CMRR	-0.2V < V <sub>CM</sub> < 1.8V	72	92		dB
Power-Supply Rejection Ratio	PSRR	2.3V ≤ V <sub>CC</sub> ≤ 7V, V <sub>OUT</sub> = 1V	82	96		dB
Input Common-Mode Voltage Range	V <sub>CM</sub>	For CMRR ≥ 72dB	Limit	-0.2	+1.8	V
			Typ	-0.2	+1.9	
Large-Signal Voltage Gain	A <sub>VOL</sub>	R <sub>L</sub> = 2kΩ to V <sub>EE</sub> , 0.3V < V <sub>OUT</sub> < 2.4V	20	120		V/mV
Output-Voltage Swing	V <sub>OUT</sub>	R <sub>L</sub> = 10kΩ to 1.35V	V <sub>CC</sub> - V <sub>OH</sub>	12	50	mV
			V <sub>OL</sub>	10	40	
		R <sub>L</sub> = 2kΩ to 1.35V	V <sub>CC</sub> - V <sub>OH</sub>	40	110	
			V <sub>OL</sub>	25	60	
Supply Current	I <sub>CC</sub>	LMX321 (single)		105	150	μA
		LMX358 (dual)		210	300	
		LMX324 (quad)		420	600	
<b>AC CHARACTERISTICS</b>						
Slew Rate	SR	1V step Input		1		V/μs
Gain-Bandwidth Product	GBW	C <sub>L</sub> = 200pF		1.3		MHz
Phase Margin	φ <sub>M</sub>			64		degrees
Gain Margin	GM			24		dB
Input Noise-Voltage Density	e <sub>n</sub>	f = 1kHz		66		nV/√Hz
Input Current-Noise Density	i <sub>n</sub>	f = 1kHz		0.13		pA/√Hz

# Single/Dual/Quad, General-Purpose, Low-Voltage, Rail-to-Rail Output Op Amps

LMX321/LMX358/LMX324

## ELECTRICAL CHARACTERISTICS

( $V_{CC} = +2.7V$ ,  $V_{EE} = 0V$ ,  $V_{OUT} = V_{CC}/2$ ,  $V_{CM} = 1V$ ,  $R_L > 1M\Omega$ ,  $T_A = -40^{\circ}C$  to  $+125^{\circ}C$ , unless otherwise noted.) (Note 1)

PARAMETER	SYMBOL	CONDITIONS	MIN	TYP	MAX	UNITS
<b>DC CHARACTERISTICS</b>						
Input Offset Voltage	$V_{OS}$				9	mV
Input Bias Current	$I_B$				70	nA
Input Offset Current	$I_{OS}$				15	nA
Common-Mode Rejection Ratio	CMRR	$-0.1 < V_{CM} < +1.7V$	60			dB
Power-Supply Rejection Ratio	PSRR	$2.3V \leq V_{CC} \leq 7V$ , $V_{OUT} = 1V$	75			dB
Input Common-Mode Voltage Range	$V_{CM}$	For CMRR $\geq 60$ dB	Limit	-0.1	+1.7	V
			Typ	-0.1	+1.8	
Large-Signal Voltage Gain	$A_{VOL}$	$R_L = 2k\Omega$ to $V_{EE}$ , $0.3V \leq V_{OUT} \leq 2.4V$	10			V/mV
Output-Voltage Swing	$V_{OUT}$	$R_L = 10k\Omega$ to 1.55V	$V_{CC} - V_{OH}$		130	mV
			$V_{OL}$		50	
		$R_L = 2k\Omega$ to 1.35V	$V_{CC} - V_{OH}$		150	
			$V_{OL}$		70	
Supply Current	$I_{CC}$	LMX321 (single)			180	$\mu A$
		LMX358 (dual)			360	
		LMX324 (quad)			720	

## ELECTRICAL CHARACTERISTICS

( $V_{CC} = +5V$ ,  $V_{EE} = 0V$ ,  $V_{OUT} = V_{CC}/2$ ,  $V_{CM} = 2V$ ,  $R_L > 1M\Omega$ ,  $T_A = +25^{\circ}C$ , unless otherwise noted.)

PARAMETER	SYMBOL	CONDITIONS	MIN	TYP	MAX	UNITS
<b>DC CHARACTERISTICS</b>						
Input Offset Voltage	$V_{OS}$			1	6	mV
Input Offset Voltage Average Drift	$TCV_{OS}$			6		$\mu V/^{\circ}C$
Input Bias Current	$I_B$			18	50	nA
Input Offset Current	$I_{OS}$			1	8	nA
Input Differential Clamp Voltage	$V_{CLAMP}$	Force 100 $\mu A$ into $IN+$ , $IN-$ = GND measure $V_{IN+} - V_{IN-}$ , Figure 1		3.1		V
Common-Mode Rejection Ratio	CMRR	$-0.2 < V_{CM} < +4.1V$	72	92		dB
Power-Supply Rejection Ratio	PSRR	$2.3V \leq V_{CC} \leq 7V$ , $V_{OUT} = 1V$ , $V_{CM} = 1V$	82	96		dB
Input Common-Mode Voltage Range	$V_{CM}$	For CMRR $\geq 72$ dB	Limit	-0.2	+4.1	V
			Typ	-0.2	+4.2	
Large-Signal Voltage Gain	$A_{VOL}$	$R_L = 2k\Omega$ to $V_{EE}$ , $0.3V \leq V_{OUT} \leq 4.7V$	40	200		V/mV

# Single/Dual/Quad, General-Purpose, Low-Voltage, Rail-to-Rail Output Op Amps

## ELECTRICAL CHARACTERISTICS (continued)

( $V_{CC} = +5V$ ,  $V_{EE} = 0V$ ,  $V_{OUT} = V_{CC}/2$ ,  $V_{CM} = 2V$ ,  $R_L > 1M\Omega$ ,  $T_A = +25^\circ C$ , unless otherwise noted.)

PARAMETER	SYMBOL	CONDITIONS	MIN	TYP	MAX	UNITS
Output-Voltage Swing	$V_{OUT}$	$R_L = 10k\Omega$ to 2.5V	$V_{CC} - V_{OH}$	20	60	mV
			$V_{OL}$	12	40	
		$R_L = 2k\Omega$ to 2.5V	$V_{CC} - V_{OH}$	65	130	
			$V_{OL}$	40	80	
Output Short-Circuit Current	$I_{SC}$	Sourcing, $V_{OUT} = 0V$	5	25	mA	
		Sinking, $V_{OUT} = 5V$	10	28		
Supply Current	$I_{CC}$	LMX321 (single)		120	170	$\mu A$
		LMX358 (dual)		240	340	
		LMX324 (quad)		480	680	
<b>AC CHARACTERISTICS</b>						
Slew Rate	SR	3V step input		1		V/ $\mu s$
Gain-Bandwidth Product	GBW	$C_L = 200pF$		1.3		MHz
Phase Margin	$\phi_M$			65		degrees
Gain Margin	GM			25		dB
Input Noise-Voltage Density	$e_n$	$f = 1kHz$		65		$nV/\sqrt{Hz}$
Input Noise-Current Density	$i_n$	$f = 1kHz$		0.13		$pA/\sqrt{Hz}$

## ELECTRICAL CHARACTERISTICS

( $V_{CC} = +5V$ ,  $V_{EE} = 0V$ ,  $V_{OUT} = V_{CC}/2$ ,  $V_{CM} = 2V$ ,  $R_L > 1M\Omega$ ,  $T_A = -40^\circ C$  to  $+125^\circ C$ , unless otherwise noted.) (Note 1)

PARAMETER	SYMBOL	CONDITIONS	MIN	TYP	MAX	UNITS
<b>DC CHARACTERISTICS</b>						
Input Offset Voltage	$V_{OS}$				9	mV
Input Bias Current	$I_B$				70	nA
Input Offset Current	$I_{OS}$				15	nA
Common-Mode Rejection Ratio	CMRR	$-0.1 < V_{CM} < +4.0V$	63			dB
Power-Supply Rejection Ratio	PSRR	$2.3V \leq V_{CC} \leq 7V$ , $V_{OUT} = 1V$ , $V_{CM} = 1V$	75			dB
Input Common-Mode Voltage Range	$V_{CM}$	For CMRR $\geq 63dB$	Limit	-0.1	+4.0	V
			Typ	-0.1	+4.1	
Large-Signal Voltage Gain	$A_{VOL}$	$R_L = 2k\Omega$ to $V_{EE}$ , $0.3V \leq V_{OUT} \leq 4.7V$	20			V/mV
Output-Voltage Swing	$V_{OUT}$	$R_L = 10k\Omega$ to 2.5V	$V_{CC} - V_{OH}$		170	mV
			$V_{OL}$		70	
		$R_L = 2k\Omega$ to 2.5V	$V_{CC} - V_{OH}$		190	
			$V_{OL}$		90	
Supply Current	$I_{CC}$	LMX321 (single)			210	$\mu A$
		LMX358 (dual)			420	
		LMX324 (quad)			840	

**Note 1:** Specifications are 100% tested at  $T_A = +25^\circ C$  (exceptions noted). All temperature limits are guaranteed by design.

# Single/Dual/Quad, General-Purpose, Low-Voltage, Rail-to-Rail Output Op Amps

## Typical Operating Characteristics

( $T_A = +25^\circ\text{C}$ ,  $V_{EE} = 0\text{V}$ , unless otherwise noted.)

LMX321/LMX358/LMX324

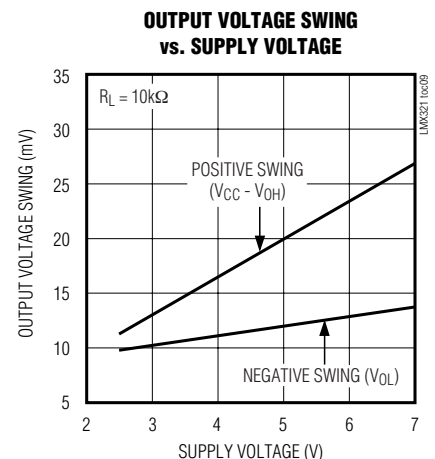
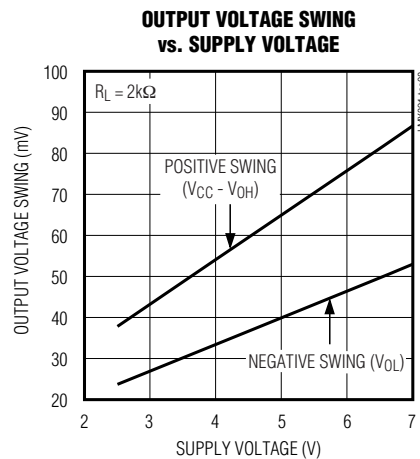
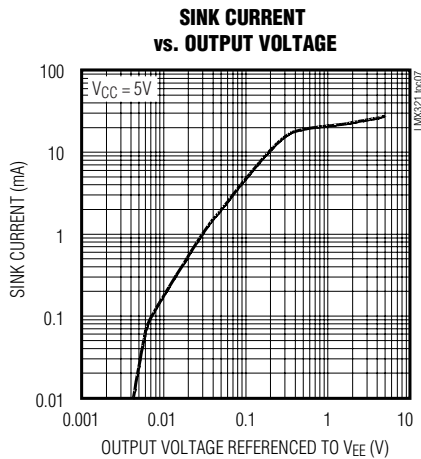
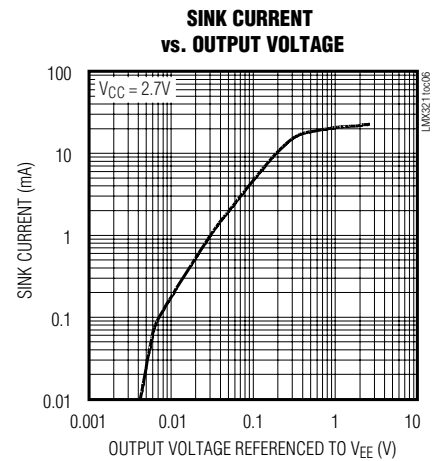
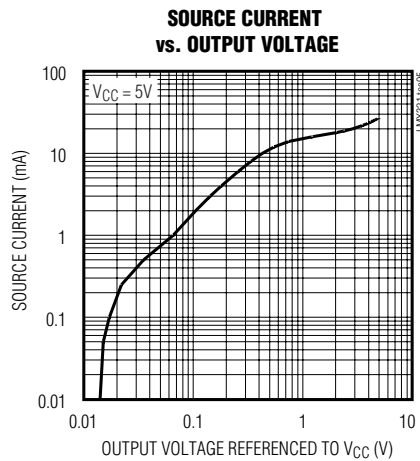
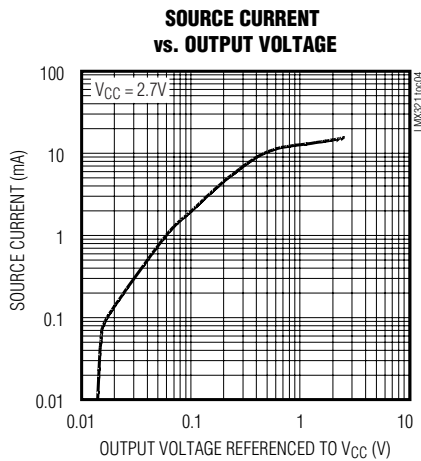
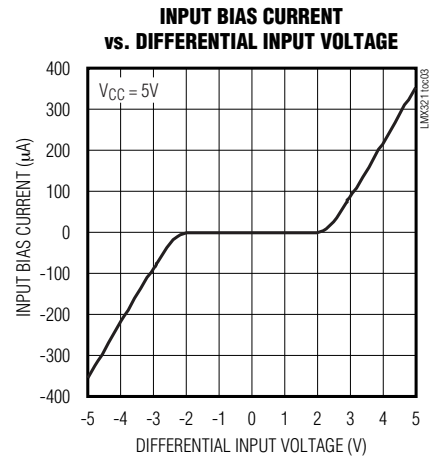
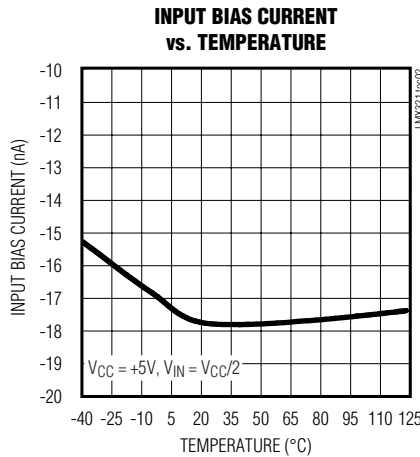
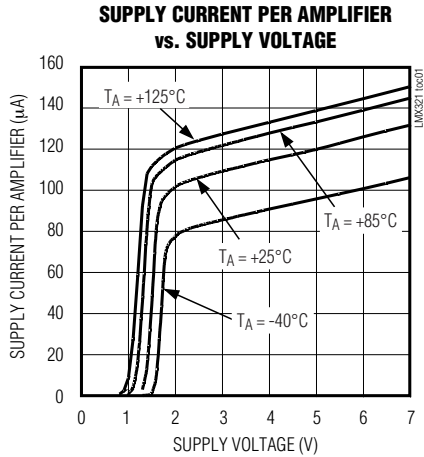

# Single/Dual/Quad, General-Purpose, Low-Voltage, Rail-to-Rail Output Op Amps

## Typical Operating Characteristics (continued)

( $T_A = +25^\circ\text{C}$ ,  $V_{EE} = 0\text{V}$ , unless otherwise noted.)

**INPUT VOLTAGE NOISE vs. FREQUENCY**

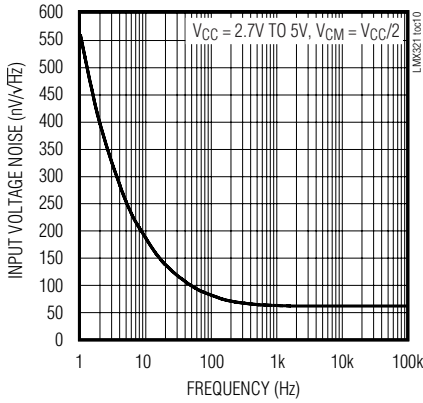

**INPUT CURRENT NOISE vs. FREQUENCY**

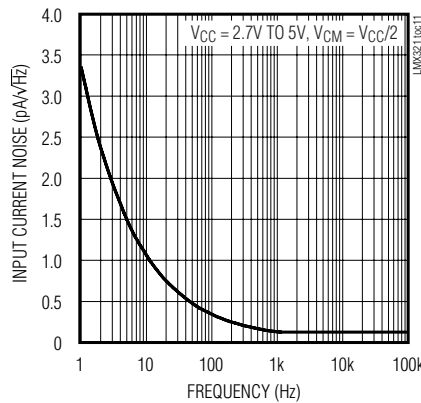

**CROSSTALK REJECTION vs. FREQUENCY**

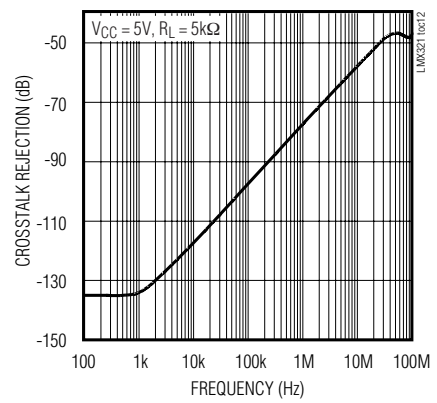

**POWER-SUPPLY REJECTION RATIO vs. FREQUENCY**

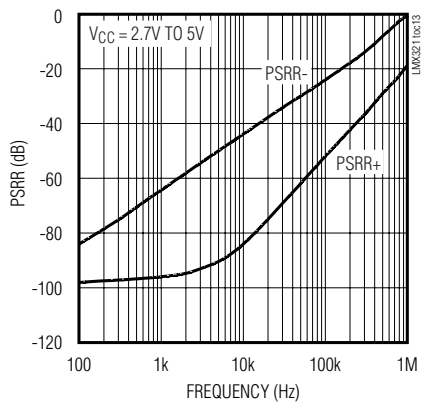

**INPUT OFFSET VOLTAGE vs. COMMON-MODE VOLTAGE**

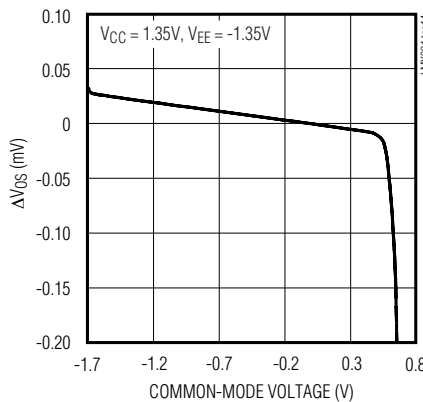

**INPUT OFFSET VOLTAGE vs. COMMON-MODE VOLTAGE**

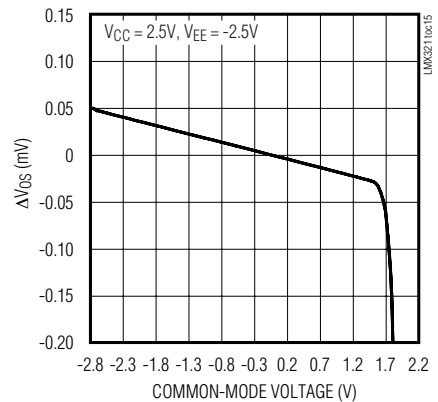

**INPUT OFFSET VOLTAGE vs. OUTPUT VOLTAGE**

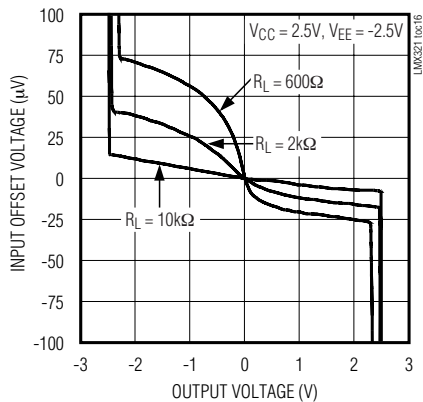

**INPUT OFFSET VOLTAGE vs. OUTPUT VOLTAGE**

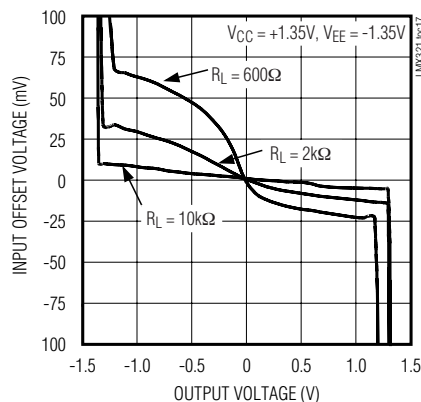

**GAIN AND PHASE vs. FREQUENCY and RESISTIVE LOAD**

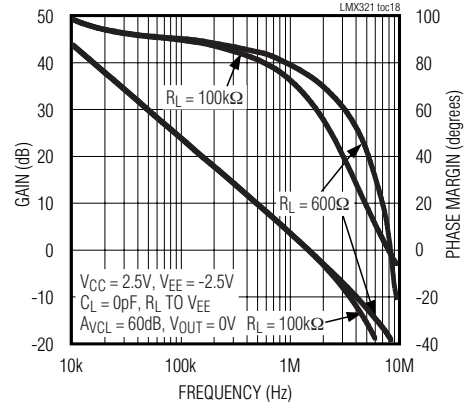

# Single/Dual/Quad, General-Purpose, Low-Voltage, Rail-to-Rail Output Op Amps

## Typical Operating Characteristics (continued)

( $T_A = +25^\circ\text{C}$ ,  $V_{EE} = 0\text{V}$ , unless otherwise noted.)

LMX321/LMX358/LMX324

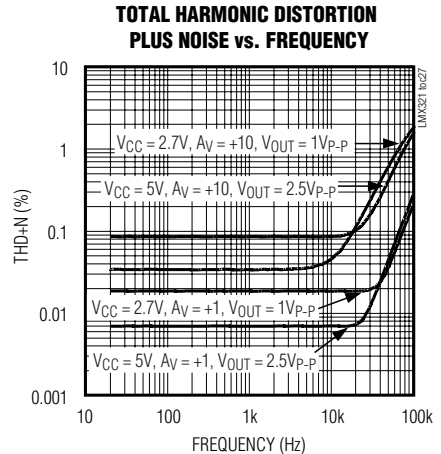
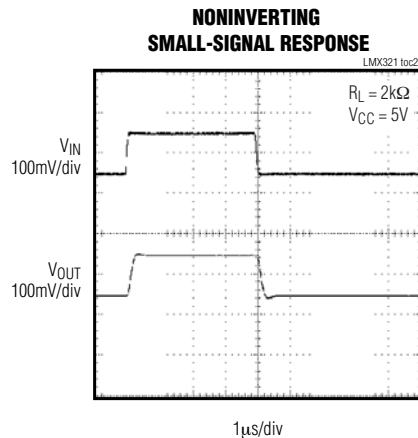
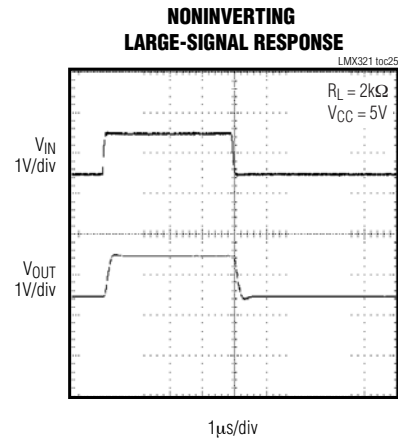
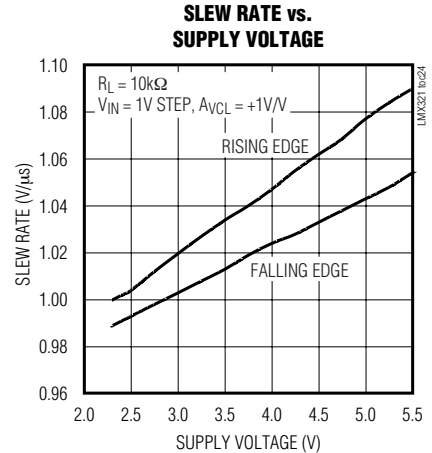
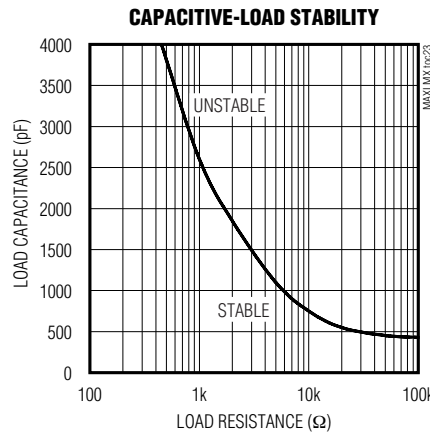
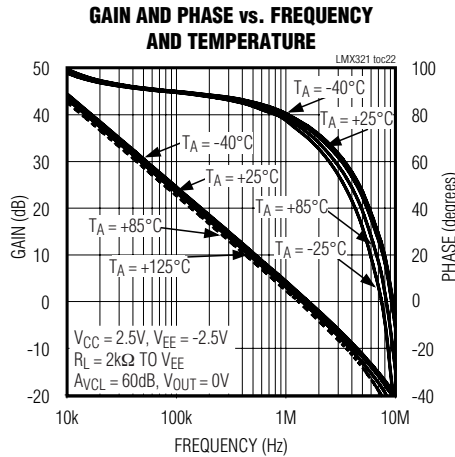
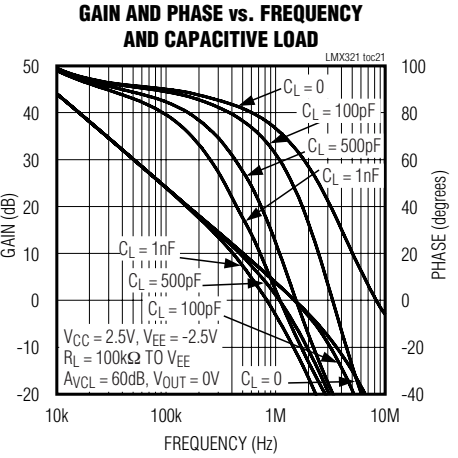
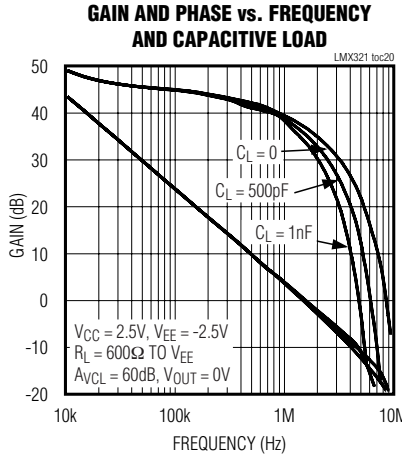
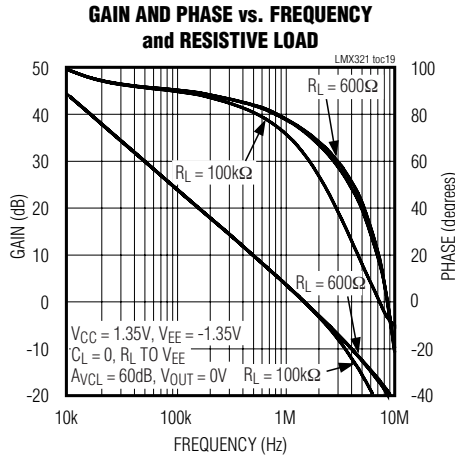

# Single/Dual/Quad, General-Purpose, Low-Voltage, Rail-to-Rail Output Op Amps

## Typical Operating Characteristics (continued)

( $T_A = +25^\circ\text{C}$ ,  $V_{EE} = 0\text{V}$ , unless otherwise noted.)

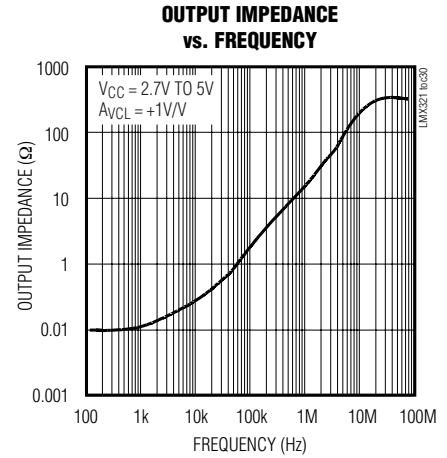
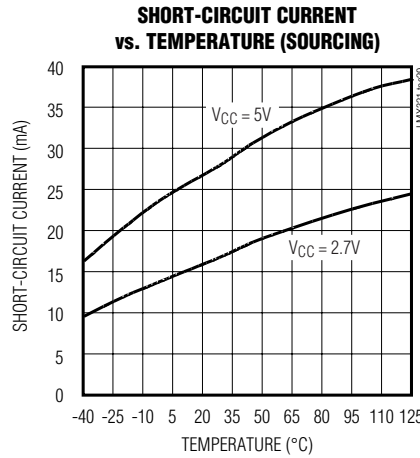
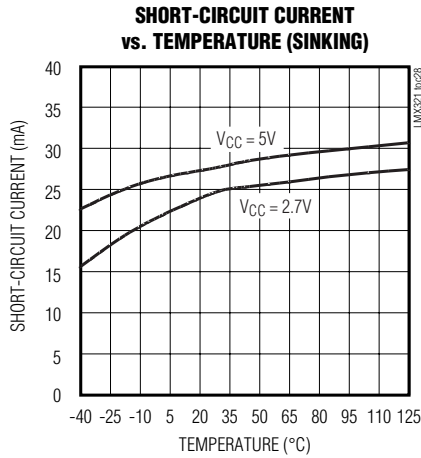

## Pin Description

PIN			NAME	FUNCTION
LMX321	LMX358	LMX324		
1	—	—	IN+	Noninverting Amplifier Input
2	4	11	VEE	Negative Supply. Connect to ground for single-supply operation.
3	—	—	IN-	Inverting Amplifier Input
4	—	—	OUT	Output
5	8	4	VCC	Positive Supply
—	1	1	OUT1	Output for Amplifier 1
—	2	2	IN1-	Inverting Input for Amplifier 1
—	3	3	IN1+	Noninverting Input for Amplifier 1
—	7	7	OUT2	Output for Amplifier 2
—	6	6	IN2-	Inverting Input for Amplifier 2
—	5	5	IN2+	Noninverting Input for Amplifier 2
—	—	8	OUT3	Output for Amplifier 3
—	—	9	IN3-	Inverting Input for Amplifier 3
—	—	10	IN3+	Noninverting Input for Amplifier 3
—	—	14	OUT4	Output for Amplifier 4
—	—	13	IN4-	Inverting Input for Amplifier 4
—	—	12	IN4+	Noninverting Input for Amplifier 4

# Single/Dual/Quad, General-Purpose, Low-Voltage, Rail-to-Rail Output Op Amps

LMX321/LMX358/LMX324

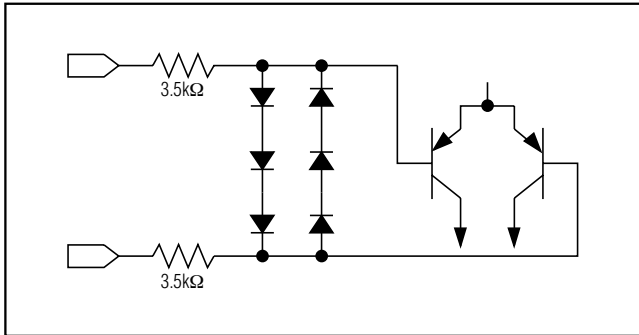

Figure 1. Input Protection Circuit

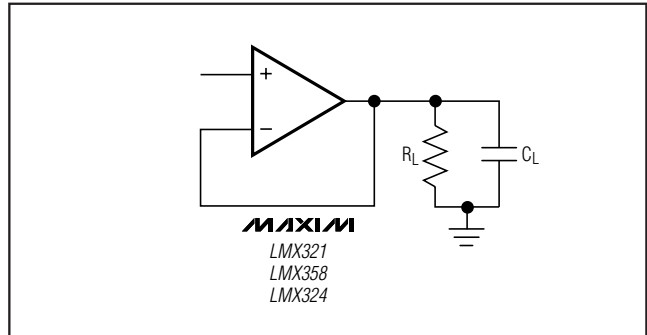

Figure 3. Capacitive-Load-Driving Circuit

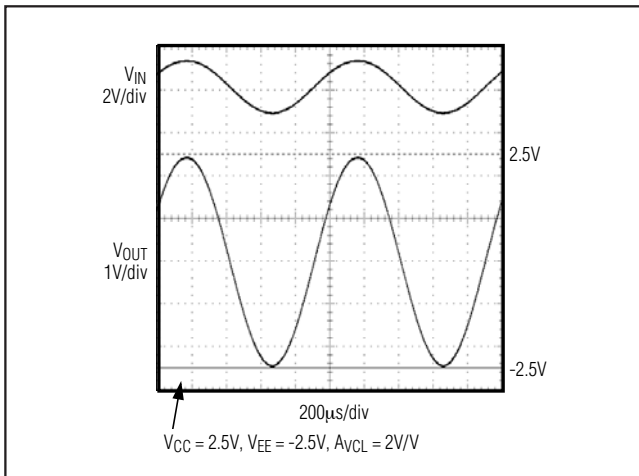

Figure 2. Rail-to-Rail Output Swing

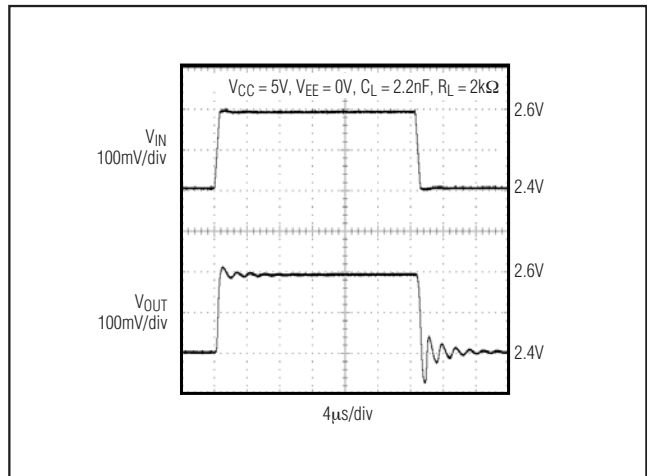

Figure 4. Output With Excessive Capacitive Load

## Detailed Description

### Input Protection Circuit

The LMX321/LMX358/LMX324's inputs are protected from large differential input voltages by internal 3.5kΩ series resistors and back-to-back triple diode stacks across the inputs (Figure 1). For differential input voltages (much less than 1.8V), input resistance is typically 3MΩ. For differential input voltages greater than 1.8V, input resistance is around 7kΩ, and the input bias current can be approximated by the following equation:

$$I_{BIAS} = (V_{DIFF} - 1.8V) / 7k\Omega$$

In the region where the differential input voltage approaches 1.8V, input resistance decreases exponentially from 3MΩ to 7kΩ as the diode block begins conducting. Inversely, the bias current increases with the same curve.

### Rail-to-Rail Output Stage

The LMX321/LMX358/LMX324 drive 2kΩ loads and still typically swing within 40mV of the supply rails. Figure 2 shows the output voltage swing of the LMX321 configured with  $A_{VCL} = +2V/V$ .

### Driving Capacitive Loads

Driving a capacitive load can cause instability in many op amps, especially those with low quiescent current. The LMX321/LMX358/LMX324 are unity-gain stable for a range of capacitive loads to above 400pF. Figure 4 shows the response of the LMX321 with an excessive capacitive load. Adding a series resistor between the output and the load capacitor (Figure 5) improves the circuit's response by isolating the load capacitance from the op amp's output.



# Single/Dual/Quad, General-Purpose, Low-Voltage, Rail-to-Rail Output Op Amps

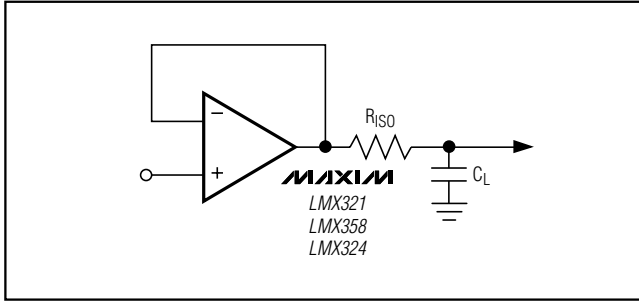

Figure 5. Capacitive-Load-Driving Circuit With Isolation Resistor

## Applications Information

### Power-Up

The LMX321/LMX358/LMX324 outputs typically settle within 10µs after power-up. Figure 6 shows the output voltage on power-up and power-down.

### Power Supplies and Layout

The LMX321/LMX358/LMX324 operate from a single +2.3V to +7V power supply. Bypass the power supply with a 0.1µF capacitor to ground as close to VCC as possible.

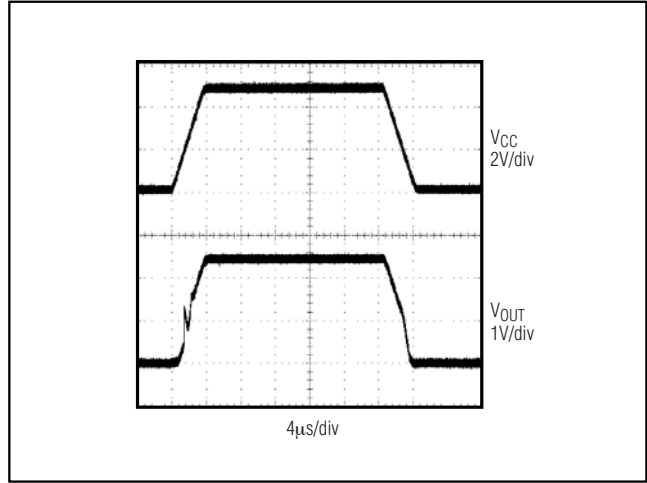

Figure 6. Power-Up/Power-Down Waveform

Good layout techniques optimize performance by minimizing the amount of stray capacitance at the op amp's inputs and outputs. Place external components close to the op amp to minimize trace lengths and stray capacitance.

## Selector Guide

PART	AMPLIFIERS PER PACKAGE	TOP MARK
LMX321AXK-T	1	ACP
LMX321AUK-T	1	ADSQ
LMX358AKA-T	2	AAIR
LMX358ASA	2	—
LMX358AUA-T	2	—
LMX324ASD	4	—
LMX324AUD	4	—

## Chip Information

LMX321 TRANSISTOR COUNT: 88  
 LMX358 TRANSISTOR COUNT: 175  
 LMX324 TRANSISTOR COUNT: 349  
 PROCESS: Bipolar

# Single/Dual/Quad, General-Purpose, Low-Voltage, Rail-to-Rail Output Op Amps

## Package Information

(The package drawing(s) in this data sheet may not reflect the most current specifications. For the latest package outline information go to [www.maxim-ic.com/packages](http://www.maxim-ic.com/packages).)

LMX321/LMX358/LMX324

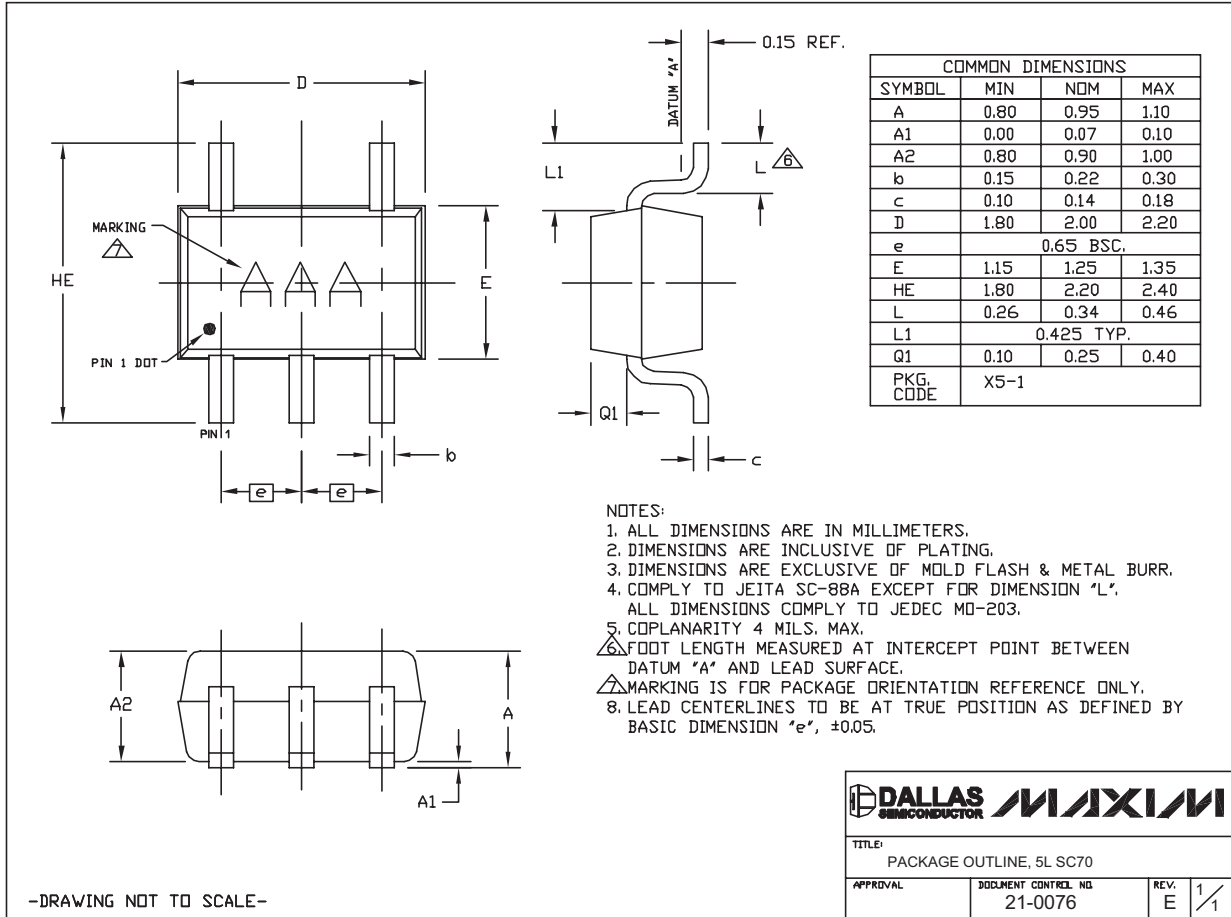

SC70, 5LEPS

# Single/Dual/Quad, General-Purpose, Low-Voltage, Rail-to-Rail Output Op Amps

## Package Information (continued)

(The package drawing(s) in this data sheet may not reflect the most current specifications. For the latest package outline information go to [www.maxim-ic.com/packages](http://www.maxim-ic.com/packages).)

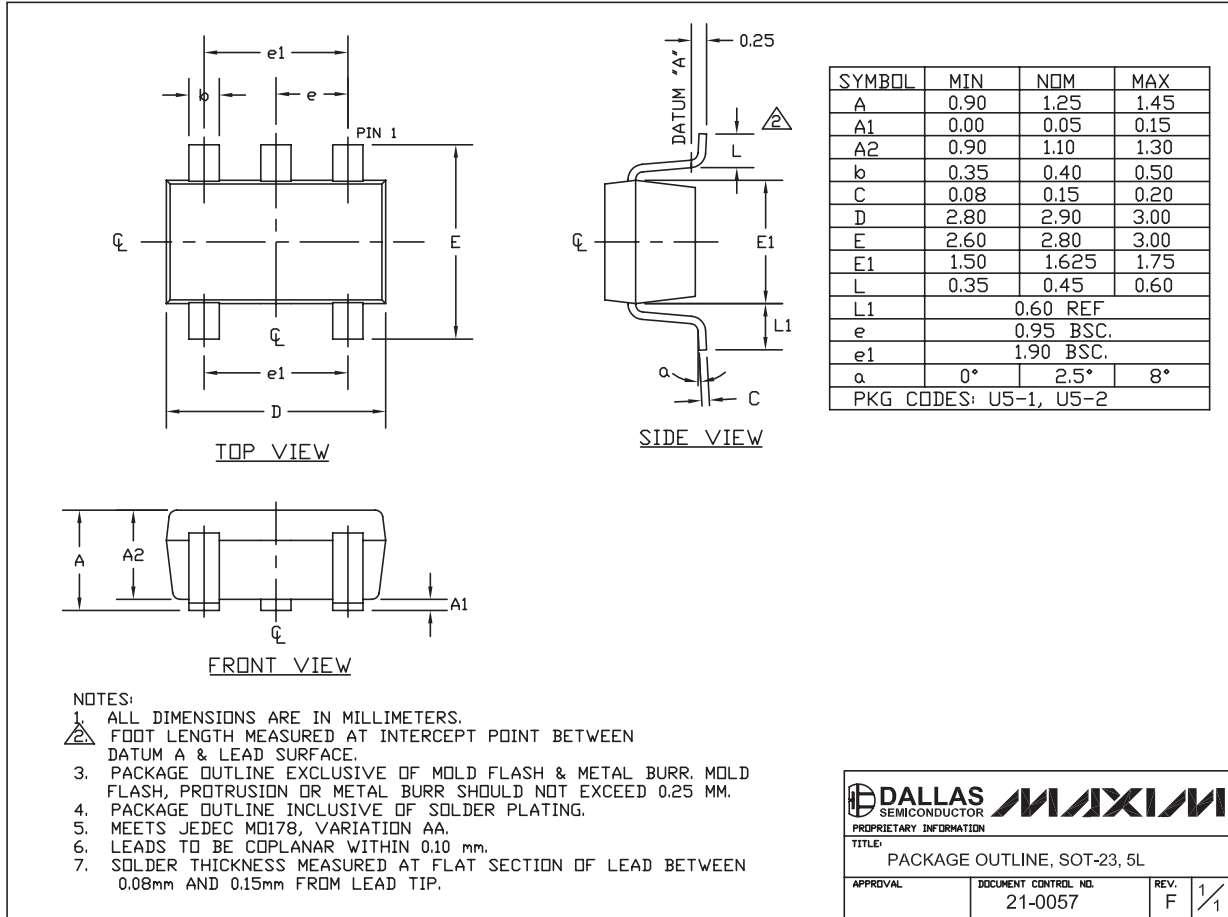

SOT-23 5L, EPS

PROPRIETARY INFORMATION			
TITLE: PACKAGE OUTLINE, SOT-23, 5L			
APPROVAL	DOCUMENT CONTROL NO. 21-0057	REV. F	1/1

# Single/Dual/Quad, General-Purpose, Low-Voltage, Rail-to-Rail Output Op Amps

## Package Information (continued)

(The package drawing(s) in this data sheet may not reflect the most current specifications. For the latest package outline information go to [www.maxim-ic.com/packages](http://www.maxim-ic.com/packages).)

LMX321/LMX358/LMX324

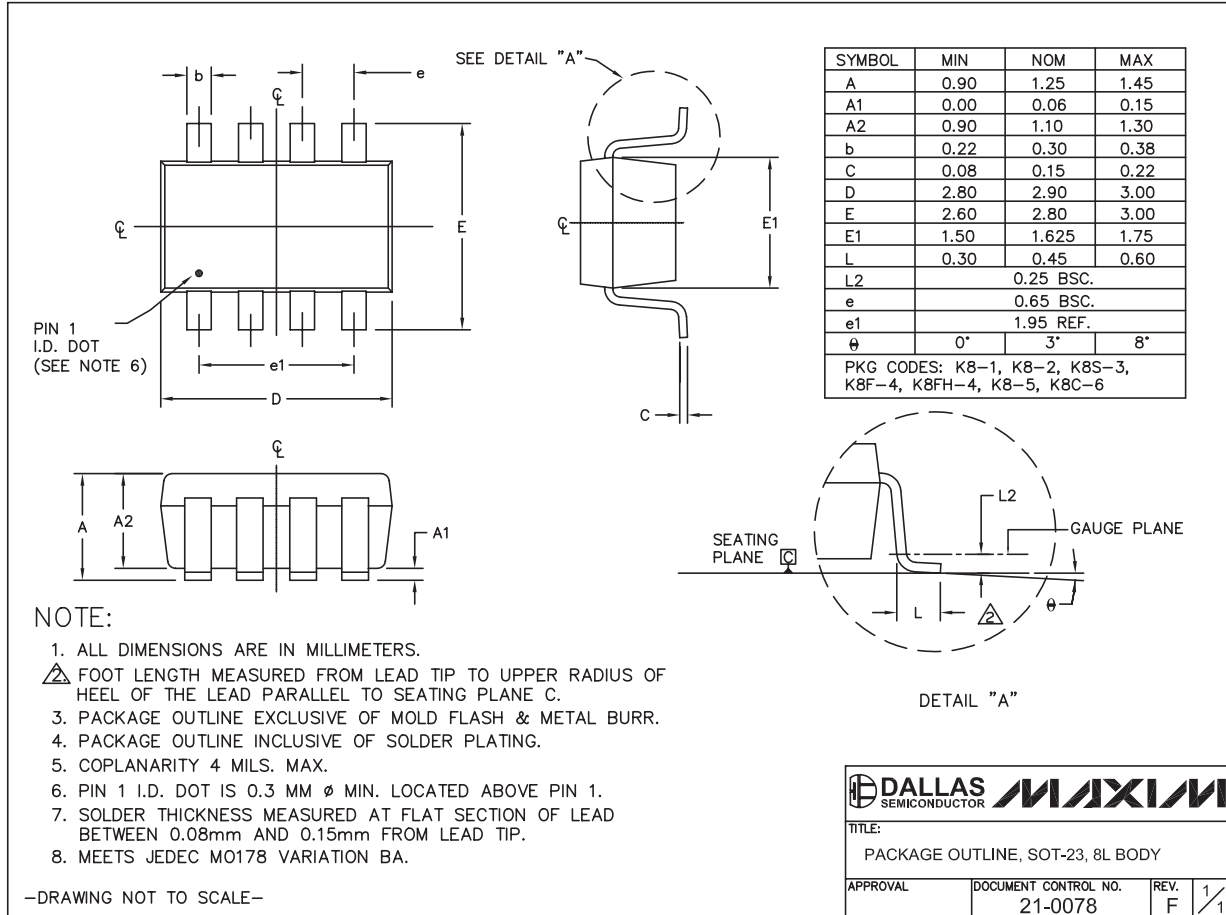

SOT23, 8L-LEPS

**DALLAS SEMICONDUCTOR** **MAXIM**

TITLE:  
PACKAGE OUTLINE, SOT-23, 8L BODY

APPROVAL	DOCUMENT CONTROL NO. 21-0078	REV. F	1/1
----------	---------------------------------	-----------	-----

# Single/Dual/Quad, General-Purpose, Low-Voltage, Rail-to-Rail Output Op Amps

## Package Information (continued)

(The package drawing(s) in this data sheet may not reflect the most current specifications. For the latest package outline information go to [www.maxim-ic.com/packages](http://www.maxim-ic.com/packages).)

8LUMAXD.EPS

DIM	INCHES		MILLIMETERS	
	MIN	MAX	MIN	MAX
A	-	0.043	-	1.10
A1	0.002	0.006	0.05	0.15
A2	0.030	0.037	0.75	0.95
b	0.010	0.014	0.25	0.36
c	0.005	0.007	0.13	0.18
D	0.116	0.120	2.95	3.05
e	0.0256 BSC		0.65 BSC	
E	0.116	0.120	2.95	3.05
H	0.188	0.198	4.78	5.03
L	0.016	0.026	0.41	0.66
α	0°	6°	0°	6°
S	0.0207 BSC		0.5250 BSC	

**NOTES:**

- D&E DO NOT INCLUDE MOLD FLASH.
- MOLD FLASH OR PROTRUSIONS NOT TO EXCEED 0.15MM (.006").
- CONTROLLING DIMENSION: MILLIMETERS.
- MEETS JEDEC MO-187C-AA.

<b>DALLAS SEMICONDUCTOR</b>		<b>MAXIM</b>	
PROPRIETARY INFORMATION			
TITLE:			
PACKAGE OUTLINE, 8L uMAX/uSOP			
APPROVAL	DOCUMENT CONTROL NO.	REV.	1/1
	21-0036	J	

# Single/Dual/Quad, General-Purpose, Low-Voltage, Rail-to-Rail Output Op Amps

## Package Information (continued)

(The package drawing(s) in this data sheet may not reflect the most current specifications. For the latest package outline information go to [www.maxim-ic.com/packages](http://www.maxim-ic.com/packages).)

LMX321/LMX358/LMX324

**COMMON DIMENSIONS**

	MILLIMETERS		INCHES	
	MIN.	MAX.	MIN.	MAX.
A	—	1.10	—	.043
A <sub>1</sub>	0.05	0.15	.002	.006
A <sub>2</sub>	0.85	0.95	.033	.037
b	0.19	0.30	.007	.012
b <sub>1</sub>	0.19	0.25	.007	.010
c	0.09	0.20	.004	.008
c <sub>1</sub>	0.09	0.14	.004	.006
D	SEE VARIATIONS		SEE VARIATIONS	
E	4.30	4.50	.169	.177
e	0.65 BSC		.026 BSC	
H	6.25	6.55	.246	.258
L	0.50	0.70	.020	.028
N	SEE VARIATIONS		SEE VARIATIONS	
α	0°	8°	0°	8°
klbl	0.10 MAX			

JEDEC MO-153	N	PKG. CODES	VARIATIONS			
			MILLIMETERS		INCHES	
			MIN.	MAX.	MIN.	MAX.
AB-1	14	U14-1J U14-2	4.90	5.10	.193	.201
AB	16	U16-1J U16-2	4.90	5.10	.193	.201
AC	20	U20-2J U20-3	6.40	6.60	.252	.260
AD	24	U24-1	7.70	7.90	.303	.311
AE	28	U28-1J U28-2J U28-3	9.60	9.80	.378	.386

**NOTES**

- DIMENSIONS D AND E DO NOT INCLUDE FLASH
- MOLD FLASH OR PROTRUSIONS NOT TO EXCEED 0.15mm PER SIDE
- CONTROLLING DIMENSION: MILLIMETER
- MEETS JEDEC OUTLINE MO-153. SEE JEDEC VARIATIONS TABLE
- "N" REFERS TO NUMBER OF LEADS
- LEAD COPLANARITY 0.10 MM MAX.
- NUMBER OF LEADS SHOWN ARE FOR REFERENCE ONLY
- MARKING IS FOR PACKAGE ORIENTATION REFERENCE ONLY
- BENT LEAD 0.10 MM MAX.

-DRAWING NOT TO SCALE-

TSSOP4, 4.0mm, EPS

**DALLAS SEMICONDUCTOR** **MAXIM**

TITLE: PACKAGE OUTLINE, TSSOP 4.40mm BODY

APPROVAL:	DOCUMENT CONTROL NO. 21-0066	REV. I	1/1
-----------	---------------------------------	-----------	-----

Maxim cannot assume responsibility for use of any circuitry other than circuitry entirely embodied in a Maxim product. No circuit patent licenses are implied. Maxim reserves the right to change the circuitry and specifications without notice at any time.

Maxim Integrated Products, 120 San Gabriel Drive, Sunnyvale, CA 94086 408-737-7600 15

# Mouser Electronics

Authorized Distributor

Click to View Pricing, Inventory, Delivery & Lifecycle Information:

## Maxim Integrated:

[LMX321AUK+T](#) [LMX321AXK+T](#) [LMX324ASD+](#) [LMX324ASD+T](#) [LMX324AUD+](#) [LMX324AUD+T](#) [LMX358ASA+](#)  
[LMX358ASA+T](#) [LMX358AUA+](#) [LMX358AUA+T](#) [LMX321AUK-T](#) [LMX321AXK-T](#) [LMX324ASD](#) [LMX324ASD-T](#)  
[LMX324AUD](#) [LMX324AUD-T](#) [LMX358AKA-T](#) [LMX358ASA](#) [LMX358ASA-T](#) [LMX358AUA](#) [LMX358AUA-T](#)  
[LMX358AKA+T](#)