

## Surface Mount Plastic PIN Diodes

Rev. V25

### Electrical Specifications @ +25°C

| Part #                         | Reverse Voltage <sup>1</sup><br>(V) | Total Capacitance <sup>2</sup><br>Maximum<br>(pF) | RS @ 10 mA <sup>3</sup><br>Maximum<br>(Ohms) | Nominal Characteristics               |                              |
|--------------------------------|-------------------------------------|---|--|---------------------------------------|------------------------------|
|                                |                                     |   |  | Carrier Lifetime <sup>4</sup><br>(µs) | I-Region Thickness<br>(mils) |
| MA4P7436<br>MADP-007436 Series | 75                                  | 1.00 @ 20 V                                       | 0.5  | 0.2                                   | 0.4                          |
| MA4P7433<br>MADP-007433 Series | 75                                  | 0.35 @ 20 V                                       | 1.5  | 0.2                                   | 0.4                          |
| MA4P7447<br>MADP-007155 Series | 100                                 | 1.20 @ 20 V                                       | 0.6  | 1.0                                   | 0.8                          |
| MADP-007448 Series             | 100                                 | 0.25 @ 50 V                                       | 2.0  | 0.4                                   | 0.6                          |
| MA4P7455<br>MADP-007455 Series | 100                                 | 0.35 @ 50 V                                       | 3.0  | 1.0                                   | 2.0                          |
| MA4P7437<br>MADP-007437 Series | 200                                 | 0.35 @ 50 V                                       | 6.0  | 2.0                                   | 4.0                          |
| MA4P7438<br>MADP-007438 Series | 200                                 | 0.35 @ 50 V                                       | 10.0   | 3.0                                   | 5.0                          |
| MADP-007167                    | 200                                 | 0.30 @ 50 V                                       | 16.0   | 3.0                                   | 7.0                          |

1. The reverse current will not exceed 10 µA at the reverse voltage rating.
2. Total capacitance is measured at 1 MHz at the indicated voltage.
3. Series resistance is measured at the specified current and a frequency of 100 MHz.
4. Nominal minority carrier lifetime is measured at  $I_F = 10$  mA,  $I_R = 6$  mA, 90% recovery.

### Absolute Maximum Ratings @ +25°C<sup>5</sup> (Unless Otherwise Noted)

| Parameter   | Rating  |
|---|---|
| Operating Temperature   | -65°C to +150°C   |
| Storage Temperature   | -65°C to +125°C   |
| Junction Temperature  | +175°C  |
| RF CW Incident Power:<br>MA4P7447, MADP-007155 Series ( $\theta$ die = 15°C/W), RF & DC Incident De-rating Coefficient = -21.3 mW/°C<br>MA4P7436, MADP-007436 Series ( $\theta$ die = 25°C/W), RF & DC Incident De-rating Coefficient = -16.8 mW/°C<br>MA4P7438, MADP-007438 Series ( $\theta$ die = 30°C/W), RF & DC Incident De-rating Coefficient = -13.3 mW/°C<br>MA4P7455, MADP-007455 Series ( $\theta$ die = 35°C/W), RF & DC Incident De-rating Coefficient = -13.3 mW/°C<br>MA4P7437, MADP-007437 Series ( $\theta$ die = 45°C/W), RF & DC Incident De-rating Coefficient = -13.3 mW/°C<br>MADP-007167 Series ( $\theta$ die = 55°C/W), RF & DC Incident De-rating Coefficient = -13.3 mW/°C<br>MA4P7433, MADP-007433 Series ( $\theta$ die = 80°C/W), RF & DC Incident De-rating Coefficient = -10.7 mW/°C<br>MADP-007448 Series ( $\theta$ die = 80°C/W), RF & DC Incident De-rating Coefficient = -10.7 mW/°C | +32 dBm<br>+31 dBm<br>+30 dBm<br>+30 dBm<br>+30 dBm<br>+30 dBm<br>+30 dBm<br>+29 dBm<br>+32 dBm |
| Total (RF + DC) Power Dissipation:<br>(SOT-23): RF & DC Dissipated De-rating Coefficient = -33.3 mW/°C<br>(SOT-323, SOD-323, SC-79): RF & DC Dissipated De-rating Coefficient = -26.7 mW/°C   | 250 mW<br>200 mW  |
| Reverse Voltage   | Voltage Rating  |
| Forward Current   | 150 mA DC   |

5. Operation of these devices above any one of these parameters may cause permanent damage.

2

MACOM Technology Solutions Inc. (MACOM) and its affiliates reserve the right to make changes to the product(s) or information contained herein without notice. Visit [www.macom.com](http://www.macom.com) for additional data sheets and product information.

For further information and support please visit:  
<https://www.macom.com/support>

DC-0007054

### Packaging and Configurations

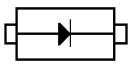
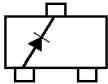
|  |   |  |   |
|---|---|---|---|
| Single  |   | Single  |   |
| SC-79 Part #  | SOD-323 Part #                                | SOT-23 Part #   | SC70 (3L) Part #                              |
| $L_s = 0.6 \text{ nH}, C_p = 0.10 \text{ pF}$                                     | $L_s = 1.3 \text{ nH}, C_p = 0.11 \text{ pF}$ | $L_s = 1.4 \text{ nH}, C_p = 0.12 \text{ pF}$                                       | $L_s = 1.3 \text{ nH}, C_p = 0.12 \text{ pF}$ |
| MADP-007436-12790T  | MA4P7436-1141T                                | MA4P7436-287T   | MA4P7436-1146T                                |
| MADP-007433-12790T  | MA4P7433-1141T                                | MA4P7433-287T   | —   |
| —   | MA4P7447-1141T                                | MA4P7447-287T   | —   |
| MADP-007448-12790T  | MADP-007448-11410T                            | MADP-007448-0287AT  | —   |
| MADP-007455-12790T  | MA4P7455-1141T                                | MA4P7455-287T   | —   |
| —   | MA4P7437-1141T                                | MA4P7437-287T   | —   |
| —   | MA4P7438-1141T                                | MA4P7438-287T   | —   |
| —   | MADP-007167-11410T                            | MADP-007167-0287AT  | —   |

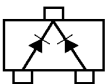
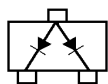
|  |   |  |   |
|---|---|---|---|
| Common Cathode  |   | Common Anode  |   |
| SOT-23 Part #   | SC70 (3L) Part #                              | SOT-23 Part #   | SC70 (3L) Part #                              |
| $L_s = 1.4 \text{ nH}, C_p = 0.12 \text{ pF}$                                       | $L_s = 1.3 \text{ nH}, C_p = 0.12 \text{ pF}$ | $L_s = 1.4 \text{ nH}, C_p = 0.12 \text{ pF}$   | $L_s = 1.3 \text{ nH}, C_p = 0.12 \text{ pF}$ |
| MA4P7436CK-287T   | MA4P7436CK-1146T                              | MA4P7436CA-287T   | MA4P7436CA-1146T                              |
| MA4P7433CK-287T   | MA4P7433CK-1146T                              | MA4P7433CA-287T   | MA4P7433CA-1146T                              |
| MA4P7447CK-287T   | —   | MA4P7447CA-287T   | —   |
| MADP-007448-0287FT  | —   | MADP-007448-0287GT  | MADP-007448-1146GT                            |
| MA4P7455CK-287T   | MA4P7455CK-1146T                              | MA4P7455CA-287T   | MA4P7455CA-1146T                              |
| MADP-007437-0287FT  | —   | MA4P7437CA-287T   | —   |
| MADP-007438-0287FT  | —   | MA4P7438CA-287T   | —   |
| MADP-007167-0287FT  | —   | MADP-007167-0287GT  | —   |

### Packaging and Configurations

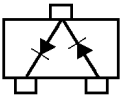
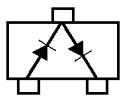
|  |   |  |   |
|---|---|---|---|
| Series Tee  |   | Series Tee Reverse  |   |
| SOT-23 Part #   | SC70 (3L) Part #                              | SOT-23 Part #   | SC70 (3L) Part #                              |
| $L_S = 1.4 \text{ nH}, C_P = 0.12 \text{ pF}$                                     | $L_S = 1.3 \text{ nH}, C_P = 0.12 \text{ pF}$ | $L_S = 1.4 \text{ nH}, C_P = 0.12 \text{ pF}$                                       | $L_S = 1.3 \text{ nH}, C_P = 0.12 \text{ pF}$ |
| MA4P7436ST-287T   | MA4P7436ST-1146T                              | MADP-007436-0287DT  | MADP-007436-1146DT                            |
| MA4P7433ST-287T   | MA4P7433ST-1146T                              | MADP-007433-0287DT  | MADP-007433-1146DT                            |
| MA4P7447ST-287T   | —   | MADP-007155-0287DT  | —   |
| MADP-007448-0287BT  | MADP-007448-1146BT                            | MADP-007448-0287DT  | MADP-007448-1146DT                            |
| MA4P7455ST-287T   | MA4P7455ST-1146T                              | MADP-007455-0287DT  | MADP-007455-1146DT                            |
| MADP-007437-0287BT  | —   | MADP-007437-0287DT  | —   |
| MADP-007438-0287BT  | —   | MADP-007438-0287DT  | —   |
| MADP-007167-0287BT  | —   | MADP-007167-0287DT  | —   |

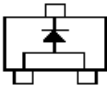
|  |
|---|
| <b>Low Inductance</b>   |
| <b>SOT-23 Part #</b>  |
| $L_S = 0.4 \text{ nH}, C_P = 0.12 \text{ pF}$                                       |
| MADP-007167-0287HT  |
| MADP-007433-0287HT  |

### Typical Forward Resistance vs. DC Bias Current Curves @ 100 MHz

**Resistance vs. Forward Current**  
(MA4P7455 /MADP-007155 Series)

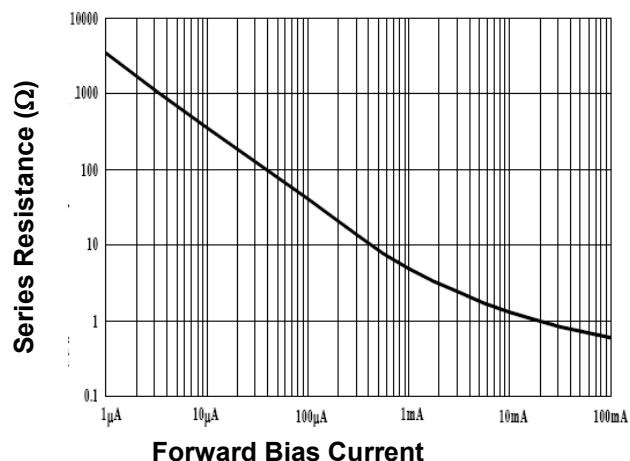

**Resistance vs. Forward Current**  
(MA4P7436 /MADP-007436 Series)

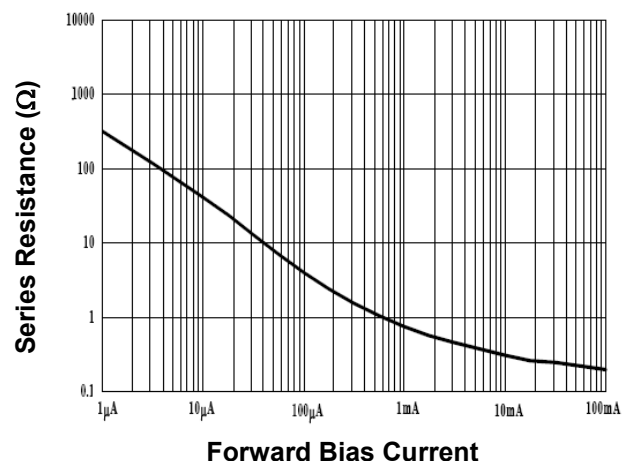

**Resistance vs. Forward Current**  
(MA4P7437 /MADP-007437 Series)

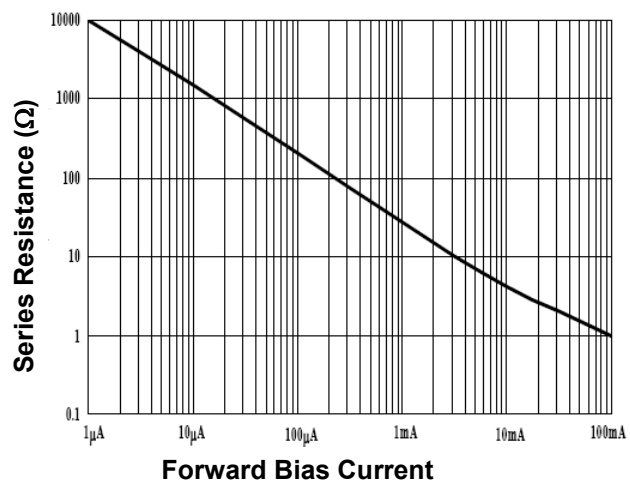

**Resistance vs. Forward Current**  
(MA4P7438 /MADP-007438 Series)

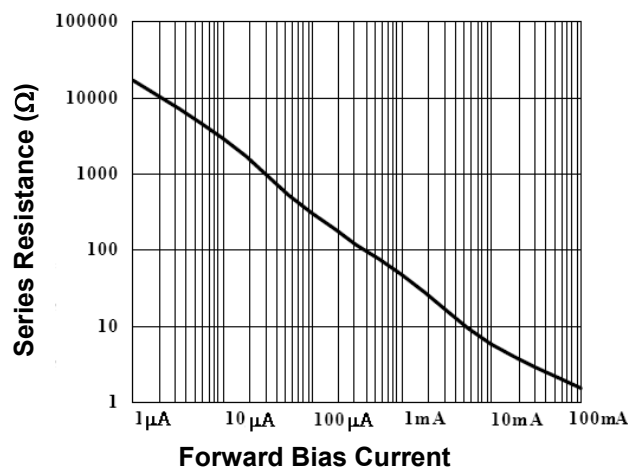

### Typical Forward Resistance vs. DC Bias Current Curves @ 100 MHz

**Resistance vs. Forward Current**  
(MA4P7447 / MADP-007155 Series)

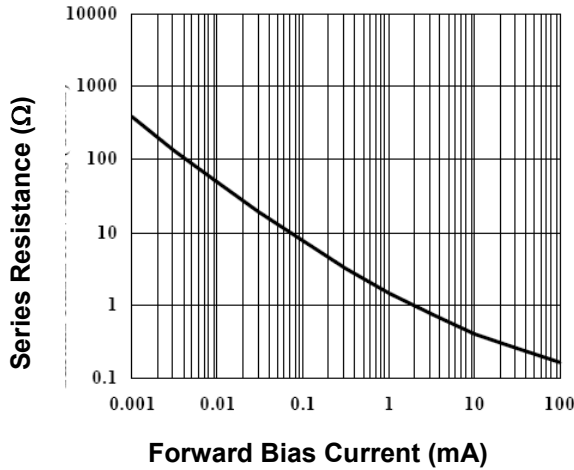

**Resistance vs. Forward Current**  
(MA4P7433/ MADP-007433 Series)

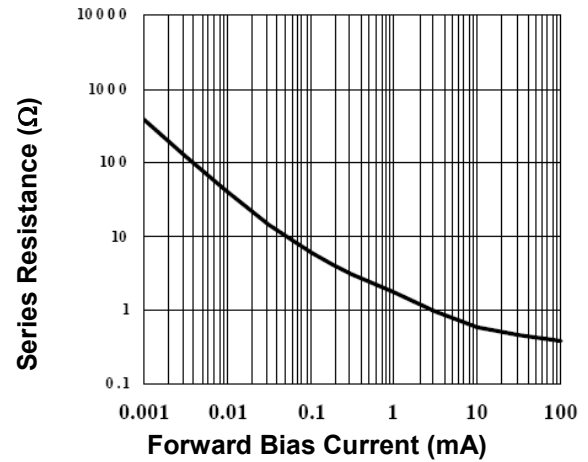

**Resistance vs. Forward Current**  
(MADP-007167 Series)

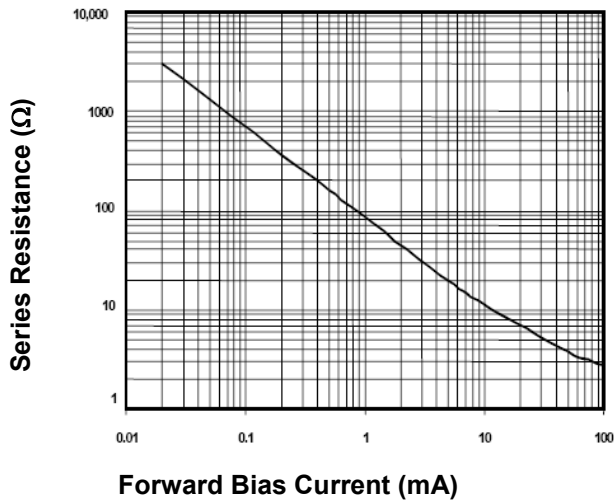

**Resistance vs. Forward Current**  
(MADP-007448 Series)

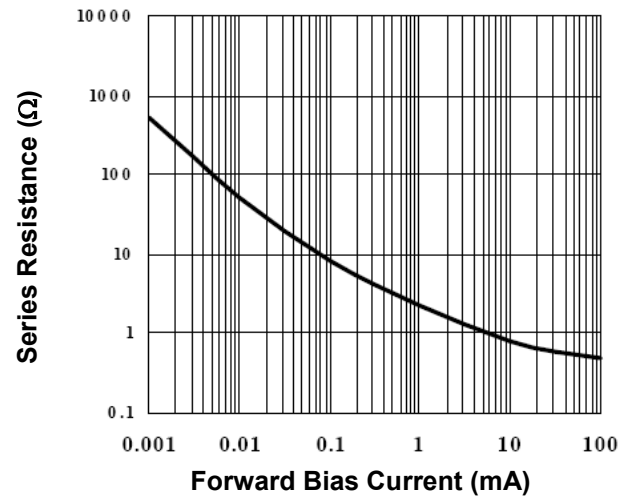

### Case Styles

#### SOT-23 (Case Style 287)

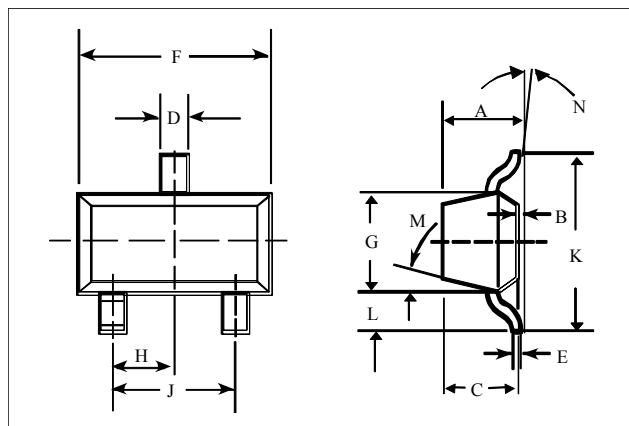

| DIM. | INCHES                |       | MILLIMETERS  |      |
|------|-----------------------|-------|--------------|------|
|      | MIN.                  | MAX.  | MIN.         | MAX. |
| A    | —                     | 0.048 | —            | 1.22 |
| B    | —                     | 0.008 | —            | 0.20 |
| C    | —                     | 0.040 | —            | 1.00 |
| D    | 0.013                 | 0.020 | 0.35         | 0.50 |
| E    | 0.003                 | 0.006 | 0.08         | 0.15 |
| F    | 0.110                 | 0.119 | 2.80         | 3.00 |
| G    | 0.047                 | 0.056 | 1.20         | 1.40 |
| H    | 0.037 typical         |       | 0.95 typical |      |
| J    | 0.075 typical         |       | 1.90 typical |      |
| K    | —                     | 0.103 | —            | 2.60 |
| L    | —                     | 0.024 | —            | 0.60 |
| DIM. | GRADIENT              |       |              |      |
| M    | 10° max. <sup>6</sup> |       |              |      |
| N    | 2° . . . 30°          |       |              |      |

6. Applicable on all sides

#### SC-70, 3 Lead (Case Style 1146)

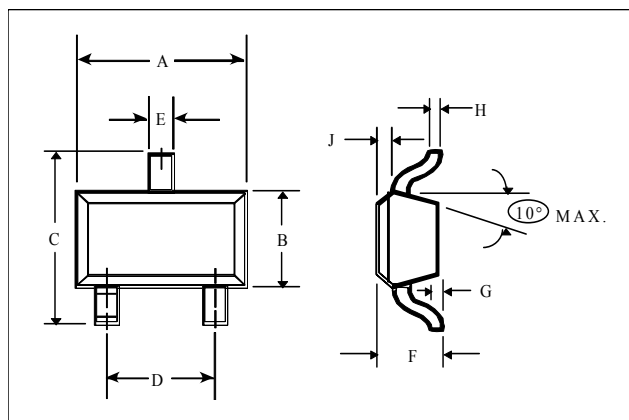

| DIM. | INCHES |       | MILLIMETERS |      |
|------|--------|-------|-------------|------|
|      | MIN.   | MAX.  | MIN.        | MAX. |
| A    | 0.071  | 0.087 | 1.80        | 2.21 |
| B    | 0.045  | 0.053 | 1.14        | 1.35 |
| C    | 0.071  | 0.094 | 1.80        | 2.39 |
| D    | 0.047  | 0.057 | 1.19        | 1.45 |
| E    | 0.010  | 0.016 | 0.25        | 0.41 |
| F    | 0.031  | 0.039 | 0.79        | 1.00 |
| G    | 0.000  | 0.004 | 0.00        | 0.10 |
| H    | 0.004  | 0.007 | 0.10        | 0.18 |
| J    | 0.004  | 0.010 | 0.10        | 0.25 |

### Case Styles (Cont'd)

#### SC-79 (Case Style 1279)

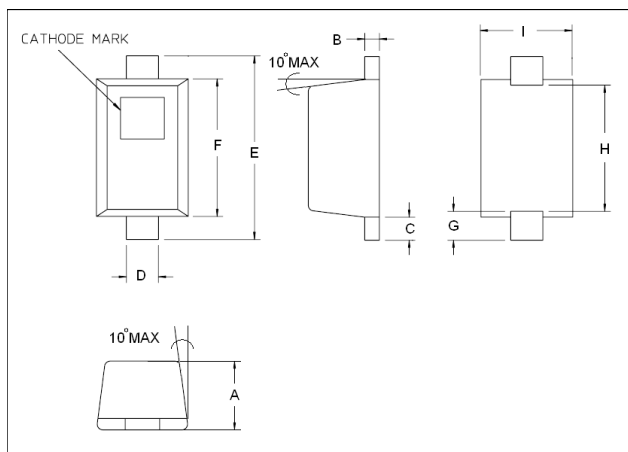

| DIM. | INCHES         |        | MILLIMETERS   |      |
|------|----------------|--------|---------------|------|
|      | MIN.           | MAX.   | MIN.          | MAX. |
| A    | 0.0197         | 0.0276 | 0.50          | 0.70 |
| B    | 0.003          | 0.008  | 0.07          | 0.20 |
| C    | 0.006          | 0.010  | 0.15          | 0.25 |
| D    | 0.010          | 0.014  | 0.25          | 0.35 |
| E    | 0.059          | 0.067  | 1.50          | 1.70 |
| F    | 0.043          | 0.051  | 1.09          | 1.30 |
| G    | 0.0098 nominal |        | 0.250 nominal |      |
| H    | 0.0433 nominal |        | 1.10 nominal  |      |
| I    | 0.027          | 0.035  | 0.68          | 0.89 |

#### SOD-323 (Case Style 1141)

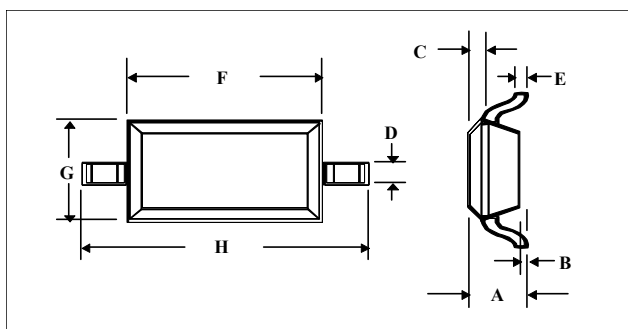

| DIM. | INCHES |       | MILLIMETERS |      |
|------|--------|-------|-------------|------|
|      | MIN.   | MAX.  | MIN.        | MAX. |
| A    | —      | 0.043 | —           | 1.1  |
| B    | —      | 0.004 | —           | 0.1  |
| C    | —      | 0.008 | —           | 0.2  |
| D    | 0.010  | 0.016 | 0.25        | 0.41 |
| E    | 0.003  | 0.006 | 0.07        | 0.15 |
| F    | 0.063  | 0.075 | 1.6         | 1.9  |
| G    | 0.045  | 0.057 | 1.14        | 1.45 |
| H    | 0.091  | 0.106 | 2.3         | 2.7  |

### Mounting Information

The illustration indicates the recommended mounting pad configuration for the SOT-23, SOT-323, SOD-323, and SC-79 packages. Solder paste containing flux should be screened onto the pads to a thickness of 0.005- 0.007 inches. The plastic package is placed in position, firmly adhering to the solder paste.

Permanent attachment is performed by a reflow soldering procedure during which the tab temperature does not exceed +275°C and the body temperature does not exceed +250°C, for standard models and +260°C for the RoHS compliant devices.

Please refer to Application Note M538 for surface mounting instructions.

### SOT-323

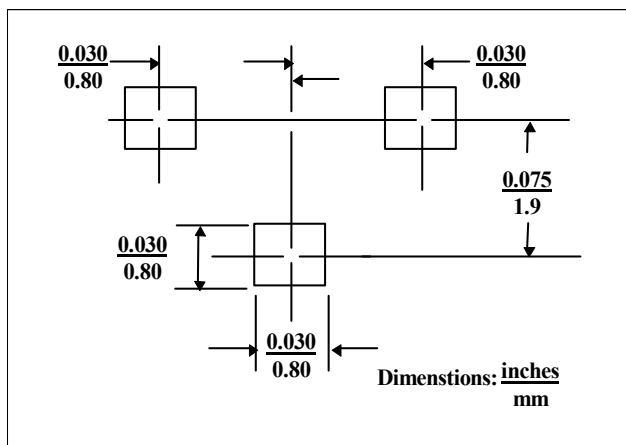

### SOT-23

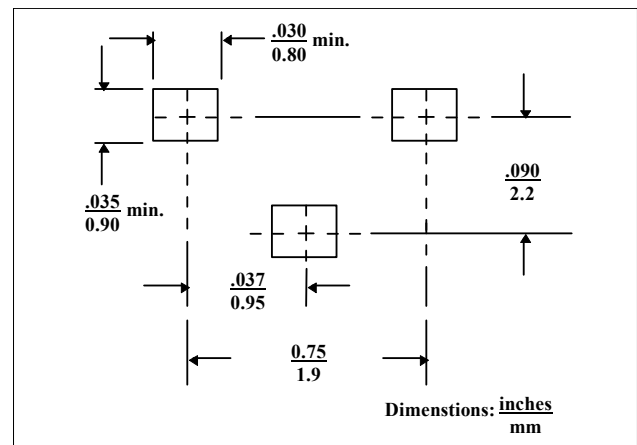

### SC-79

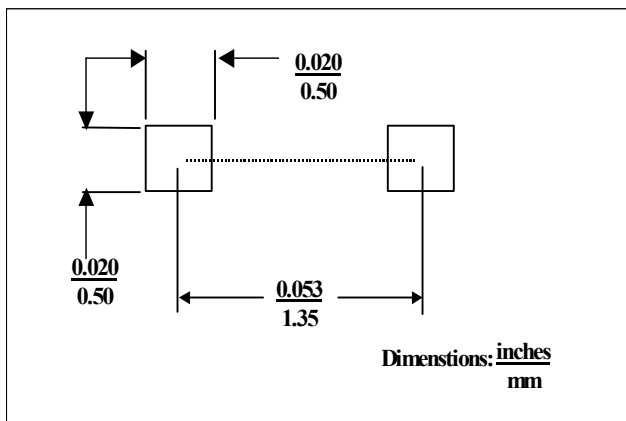

### SOD-323

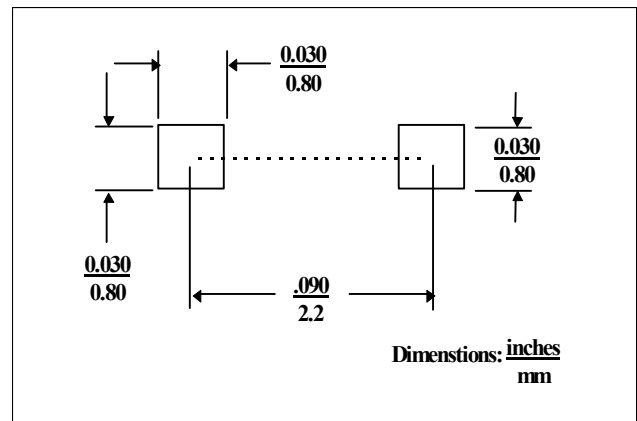



MACOM Technology Solutions Inc. All rights reserved.

Information in this document is provided in connection with MACOM Technology Solutions Inc ("MACOM") products. These materials are provided by MACOM as a service to its customers and may be used for informational purposes only. Except as provided in MACOM's Terms and Conditions of Sale for such products or in any separate agreement related to this document, MACOM assumes no liability whatsoever. MACOM assumes no responsibility for errors or omissions in these materials. MACOM may make changes to specifications and product descriptions at any time, without notice. MACOM makes no commitment to update the information and shall have no responsibility whatsoever for conflicts or incompatibilities arising from future changes to its specifications and product descriptions. No license, express or implied, by estoppel or otherwise, to any intellectual property rights is granted by this document.

THESE MATERIALS ARE PROVIDED "AS IS" WITHOUT WARRANTY OF ANY KIND, EITHER EXPRESS OR IMPLIED, RELATING TO SALE AND/OR USE OF MACOM PRODUCTS INCLUDING LIABILITY OR WARRANTIES RELATING TO FITNESS FOR A PARTICULAR PURPOSE, CONSEQUENTIAL OR INCIDENTAL DAMAGES, MERCHANTABILITY, OR INFRINGEMENT OF ANY PATENT, COPYRIGHT OR OTHER INTELLECTUAL PROPERTY RIGHT. MACOM FURTHER DOES NOT WARRANT THE ACCURACY OR COMPLETENESS OF THE INFORMATION, TEXT, GRAPHICS OR OTHER ITEMS CONTAINED WITHIN THESE MATERIALS. MACOM SHALL NOT BE LIABLE FOR ANY SPECIAL, INDIRECT, INCIDENTAL, OR CONSEQUENTIAL DAMAGES, INCLUDING WITHOUT LIMITATION, LOST REVENUES OR LOST PROFITS, WHICH MAY RESULT FROM THE USE OF THESE MATERIALS.

MACOM products are not intended for use in medical, lifesaving or life sustaining applications. MACOM customers using or selling MACOM products for use in such applications do so at their own risk and agree to fully indemnify MACOM for any damages resulting from such improper use or sale.

# Mouser Electronics

Authorized Distributor

Click to View Pricing, Inventory, Delivery & Lifecycle Information:

## MACOM:

[MA4P789CK-287T](#) [MA4P275ST-287T](#) [MA4P7433CK-287T](#) [MA4P7447-287T](#) [MA4P7455-1141T](#) [MADP-007167-12250T](#) [MADP-007155-0287DT](#) [MADP-007167-0287AT](#) [MADP-007167-0287DT](#) [MADP-007433-0287DT](#) [MADP-007455-12790T](#) [MA4P7433ST-287T](#) [MA4P7441F-1091T](#) [MA4P7433-1141T](#) [MA4PH237-1079T](#) [MA4P7455CK-287T](#) [MA4P7433-287T](#) [MA4P161-134](#) [MA4P404-132](#) [MA4P7447-1141T](#) [MA4P7455-1146T](#) [MA4P7433CA-287T](#) [MA4P7436-1146T](#) [MA4P7436CK-1146T](#) [MA4P7436ST-287T](#) [MA4P7438-1146T](#) [MA4P7447-1146T](#) [MA4P7447CA-287T](#) [MA4P7447CK-287T](#) [MA4P7433CK-1146T](#) [MA4P282CK-287T](#) [MA4P282-1146T](#) [MA4P290-287T](#) [MA4P275STR-287T](#) [MA4P277CK-287T](#) [MA4P274ST-287T](#) [MA4P290-1225T](#) [MA4P275CK-1146T](#) [MA4P274-1225T](#) [MA4P504-30](#) [MA4P282CA-287T](#) [MA4P275-287T](#) [MA4P282STR-287T](#) [MA4P290CK-287T](#) [MA4P282-287T](#) [MA4P789STR-287T](#) [MA4P274CK-1146T](#) [MA4P282ST-287T](#) [MA4P789-287T](#) [MA4P277-287T](#) [MA4P789CK-1146T](#) [MA4P789ST-287T](#) [MADP-007436-0287DT](#) [MADP-007448-0287DT](#) [MADP-007448-0287BT](#) [MADP-007436-1146DT](#) [MADP-007448-0287FT](#) [MADP-007448-1146DT](#) [MADP-007448-12790T](#) [MADP-007455-0287DT](#) [MADP-007455-1146DT](#) [MADP-007436-12790T](#) [MADP-007437-0287BT](#) [MADP-007437-0287FT](#) [MADP-007438-0287BT](#) [MADP-007438-0287FT](#) [MADP-007448-0287AT](#) [MADP-007455-001SMB](#)