

Table 2. Absolute Maximum Ratings

Symbol	Parameter	Value	Unit
V_s	Supply Voltage	20	V
I_O	Output Peak Current (internally limited)	2	A
P_{tot}	Total Power Dissipation ($T_{amb} = 70^{\circ}C$)	33	W
T_{op}	Operating Temperature	0 to 70	$^{\circ}C$
T_{stg}, T_j	Storage and Junction Temperature	-40 to 150	$^{\circ}C$

Table 3. Thermal Data

Symbol	Parameter	Value	Unit
$R_{th\ j-case}$	Thermal Resistance Junction-case	2.1	$^{\circ}C/W$

Figure 3. PIN CONNECTION

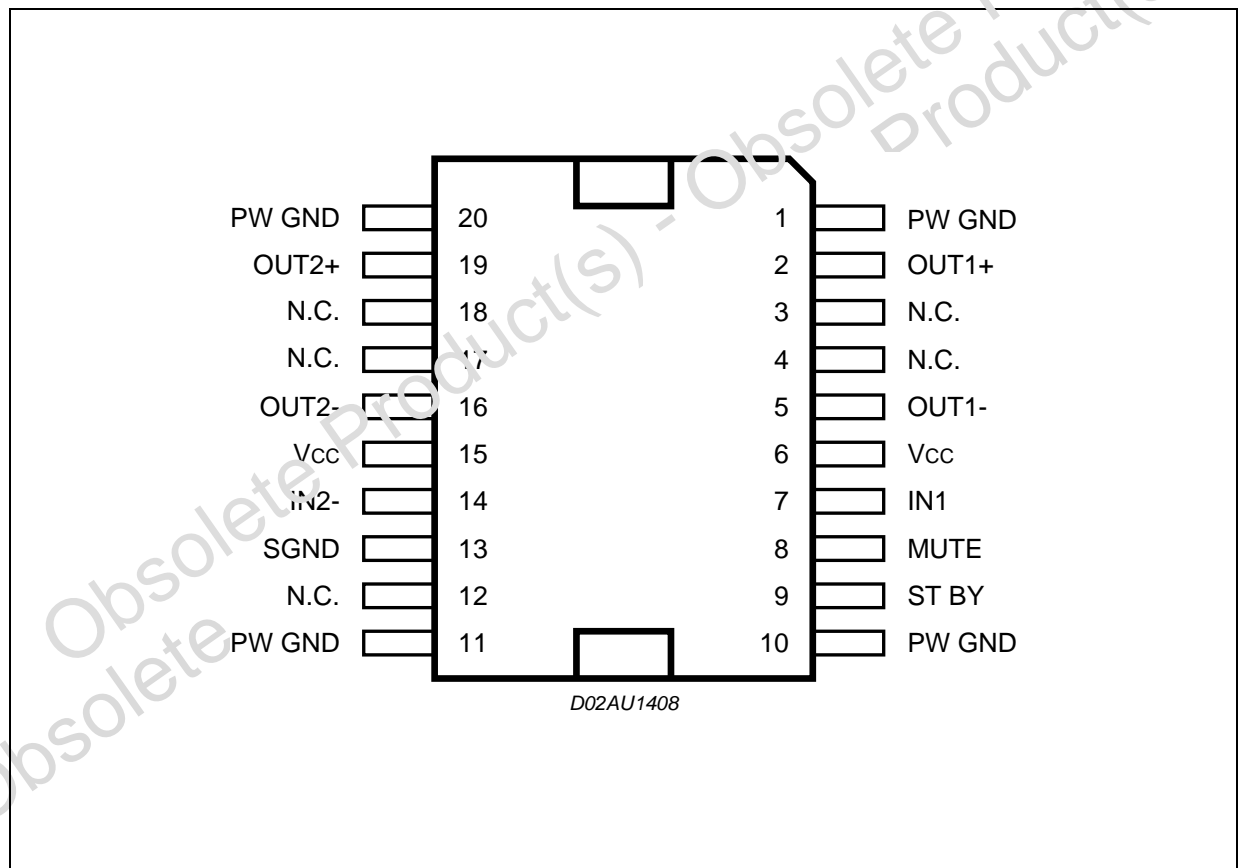

Table 4. Electrical Characteristics ($V_{CC} = 13V$, $R_L = 8\Omega$, $f = 1KHz$, $T_{amb} = 25^\circ C$ unless otherwise specified)

Symbol	Parameter	Test Condition	Min.	Typ.	Max.	Unit
V_{CC}	Supply Range		6.5		18	V
I_q	Total Quiescent Current	$R_L = \infty$		50	65	mA
V_{OS}	Output Offset Voltage				120	mV
P_O	Output Power	THD 10%	8.3	10		W
THD	Total Harmonic Distortion	$P_O = 1W$		0.1	0.3	%
		$P_O = 0.1W$ to $5W$ $f = 100Hz$ to $15KHz$			1	%
SVR	Supply Voltage Rejection	$f = 100Hz$, $V_R = 0.5V$	40	56		dB
CT	Crosstalk		46	60		dB
A_{MUTE}	Mute Attenuation		60	50		dB
T_w	Thermal Threshold			150		$^\circ C$
G_V	Closed Loop Voltage Gain		31	32	33	dB
ΔG_V	Voltage Gain Matching				0.5	dB
R_i	Input Resistance		25	30		$K\Omega$
$V_{T_{MUTE}}$	Mute Threshold	$V_o = -30dB$	2.3	2.9	4.1	V
$V_{T_{ST-BY}}$	St-by Threshold		0.8	1.3	1.8	V
I_{ST-BY}	St-by Current				100	μA
e_N	Total Output Noise Voltage	A Curve $f = 20Hz$ to $20KHz$		150 220	500	μV μV

3 APPLICATION SUGGESTIONS

STAND-BY AND MUTE FUNCTIONS

3.1 Microprocessor Application

In order to avoid annoying "Pop-Noise" during Turn-On/Off transients, it is necessary to guarantee the right St-by and mute signals sequence. It is quite simple to obtain this function using a microprocessor (Fig. 4 and 5).

At first St-by signal (from μP) goes high and the voltage across the St-by terminal (Pin 9) starts to increase exponentially. The external RC network is intended to turn-on slowly the biasing circuits of the amplifier, this to avoid "POP" and "CLICK" on the outputs.

When this voltage reaches the St-by threshold level, the amplifier is switched-on and the external capacitors in series to the input terminals (C1, C3) start to charge.

It's necessary to maintain the mute signal low until the capacitors are fully charged, this to avoid that the device goes in play mode causing a loud "Pop Noise" on the speakers.

A delay of 100-200ms between St-by and mute signals is suitable for a proper operation.

Figure 4. Microprocessor Application

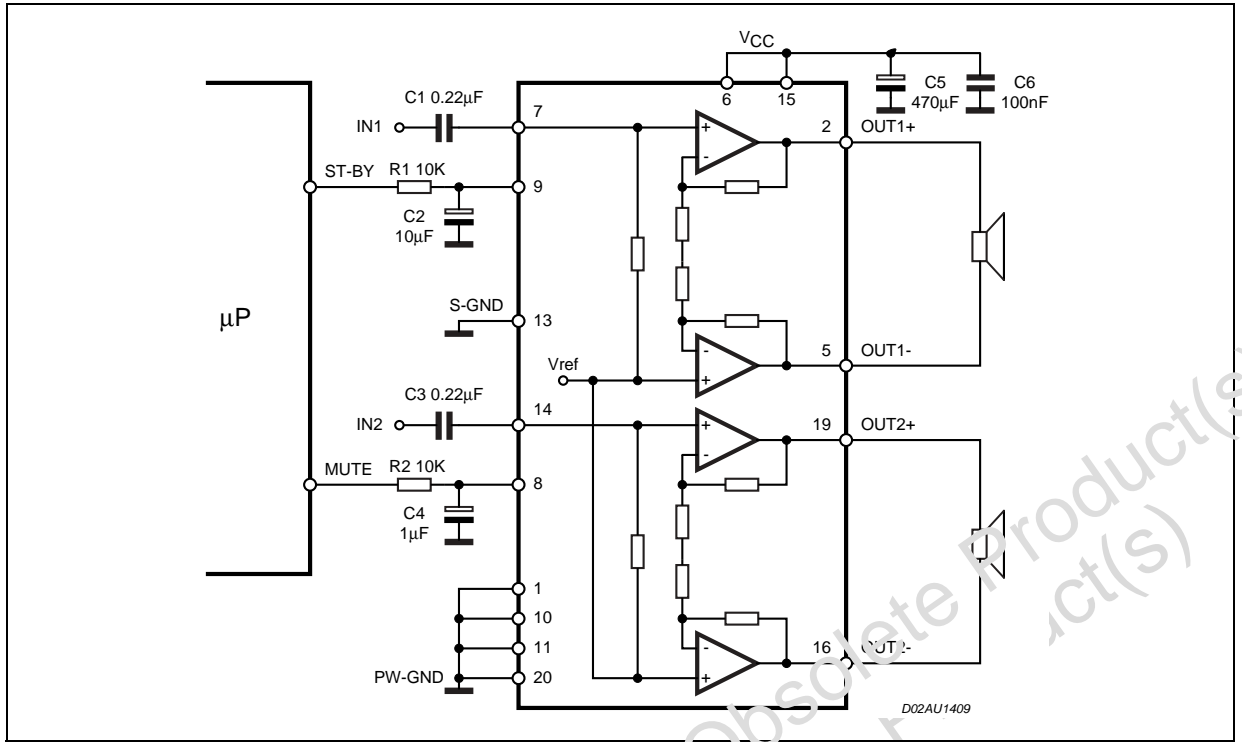

Figure 5. Microprocessor Driving Signals

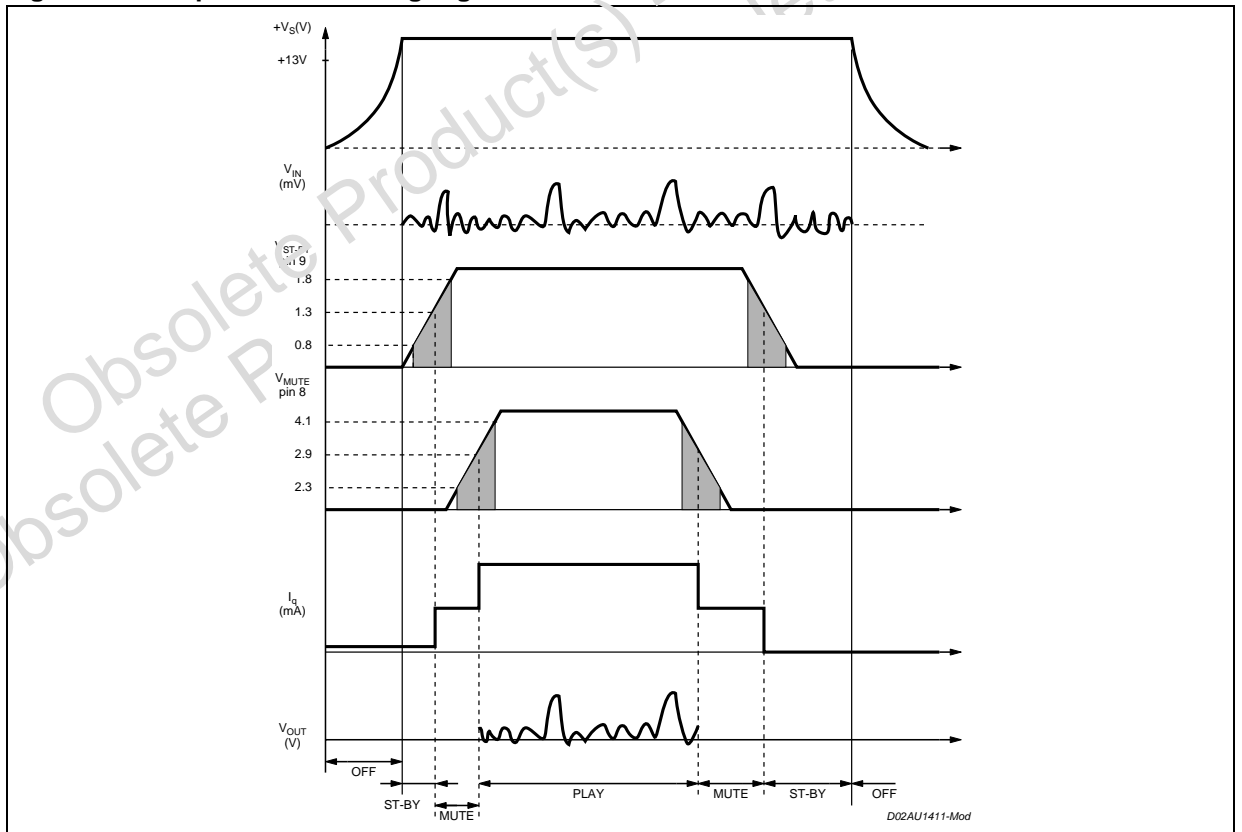

Figure 6. THD+N vs Output Power

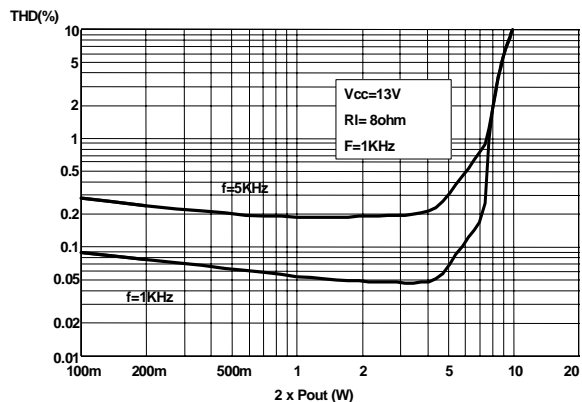

Figure 9. Frequency Response

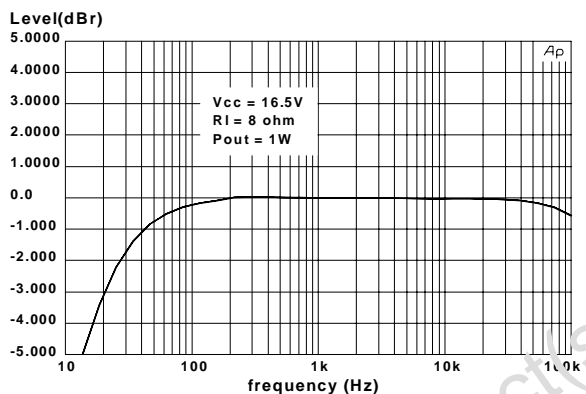

Figure 7. THD+N vs Output Power

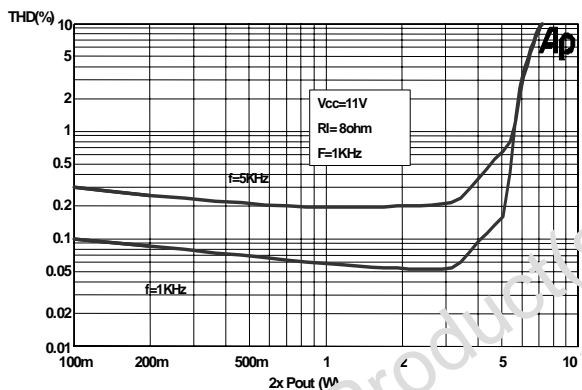

Figure 10. Output Power vs supply Voltage

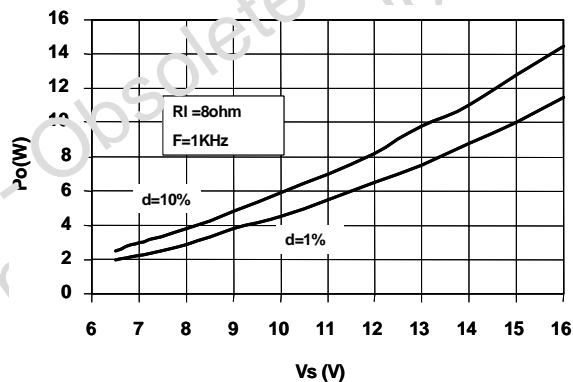

Figure 8. THD+N vs Frequency

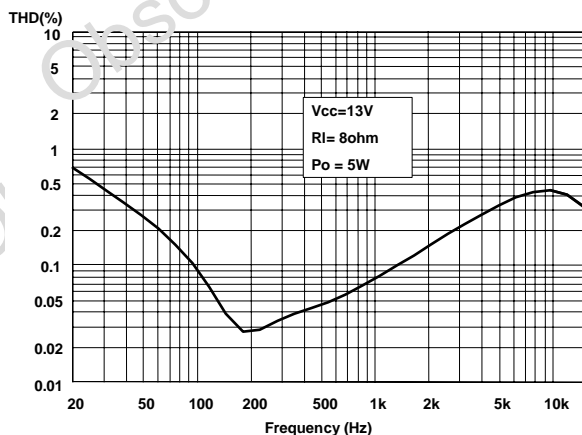

Figure 11. Power Dissipation vs Pout

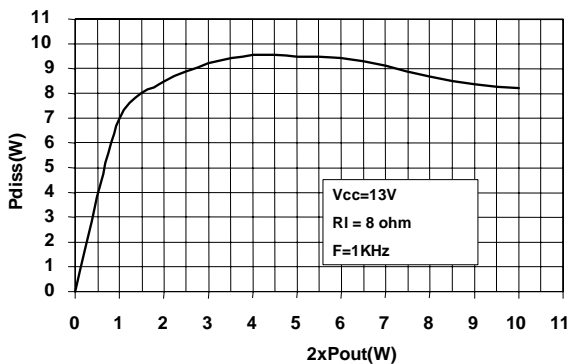

Figure 12. Mute Attenuation vs. Vpin 8t

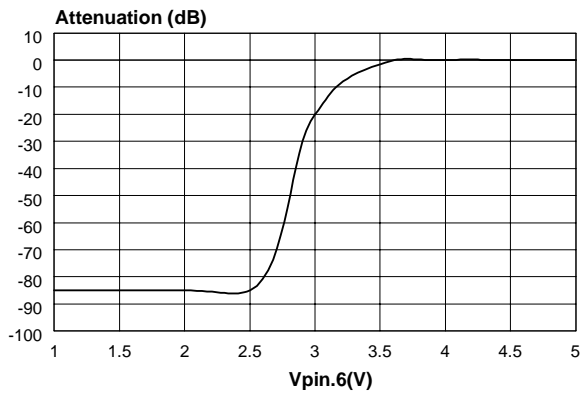

Figure 14. Quiescent Current vs. Supply Voltage

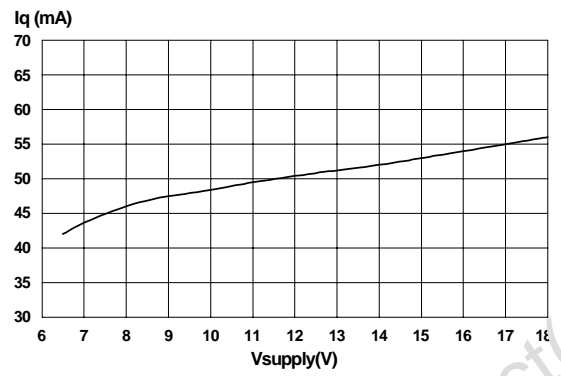
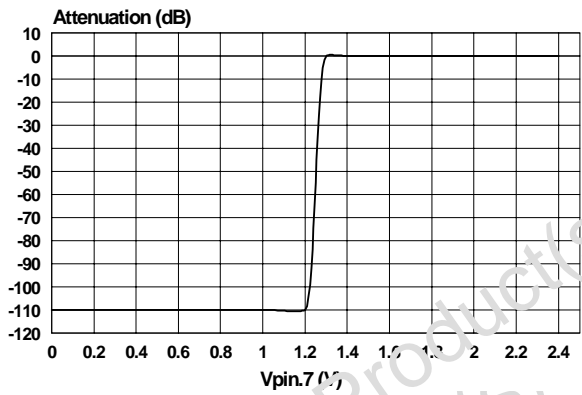

Figure 13. Standard-By Attenuation vs Vpin. 9



Obsolete Product(s) - Obsolete Product(s)
 Obsolete Product(s), Obsolete Product(s)

Figure 15. PC Board Component Layout

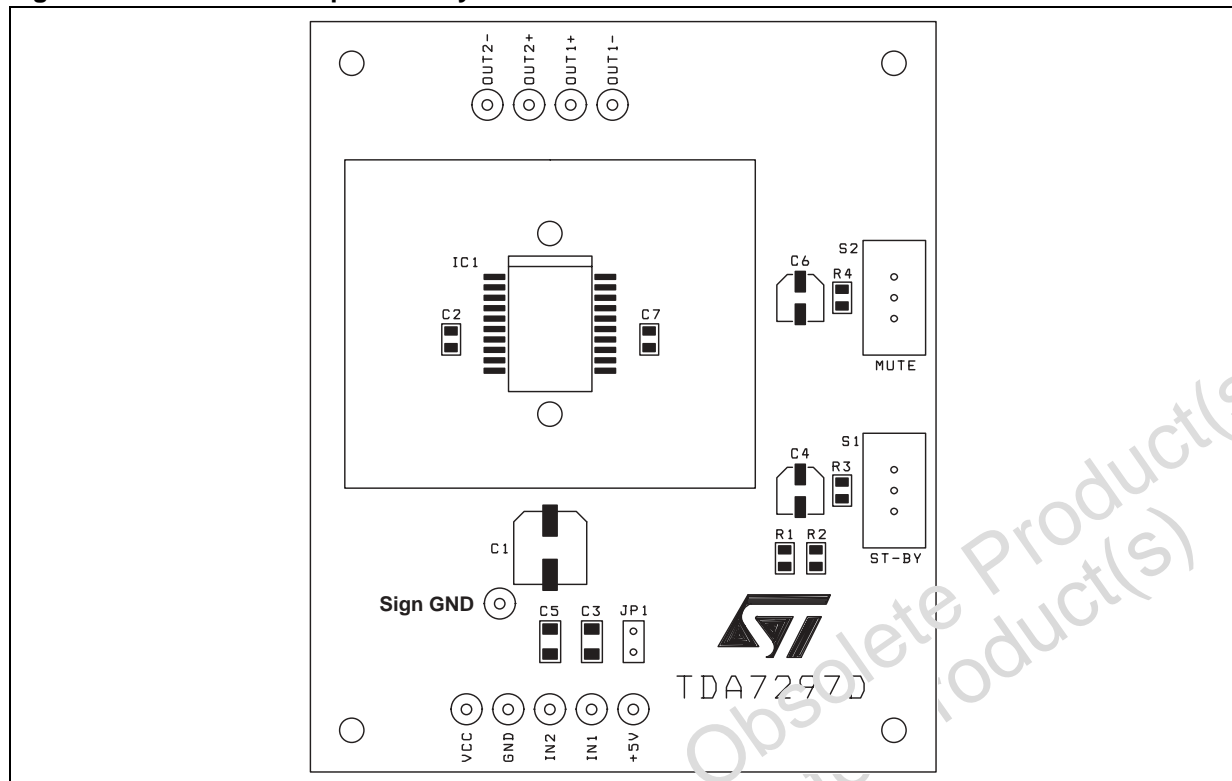

Figure 16. Evaluation Board Top Layer Layout

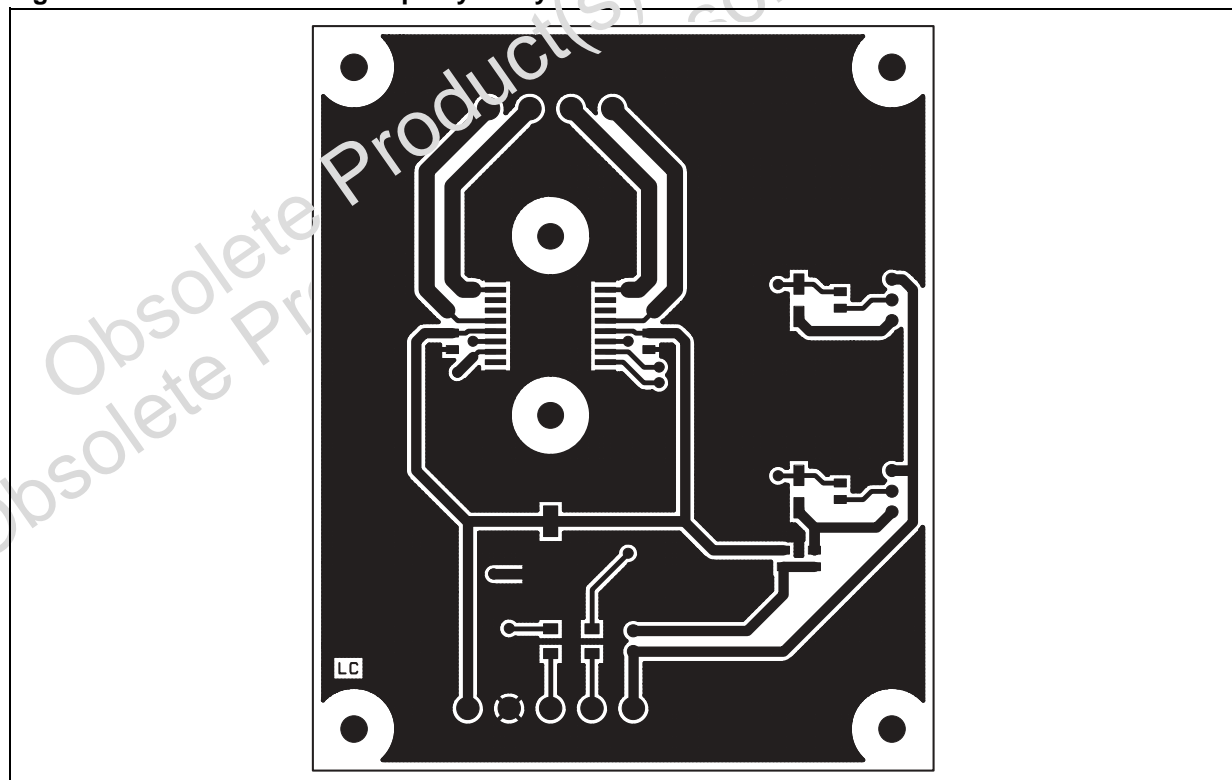

Figure 17. Evaluation Board Bottom Layer Layout

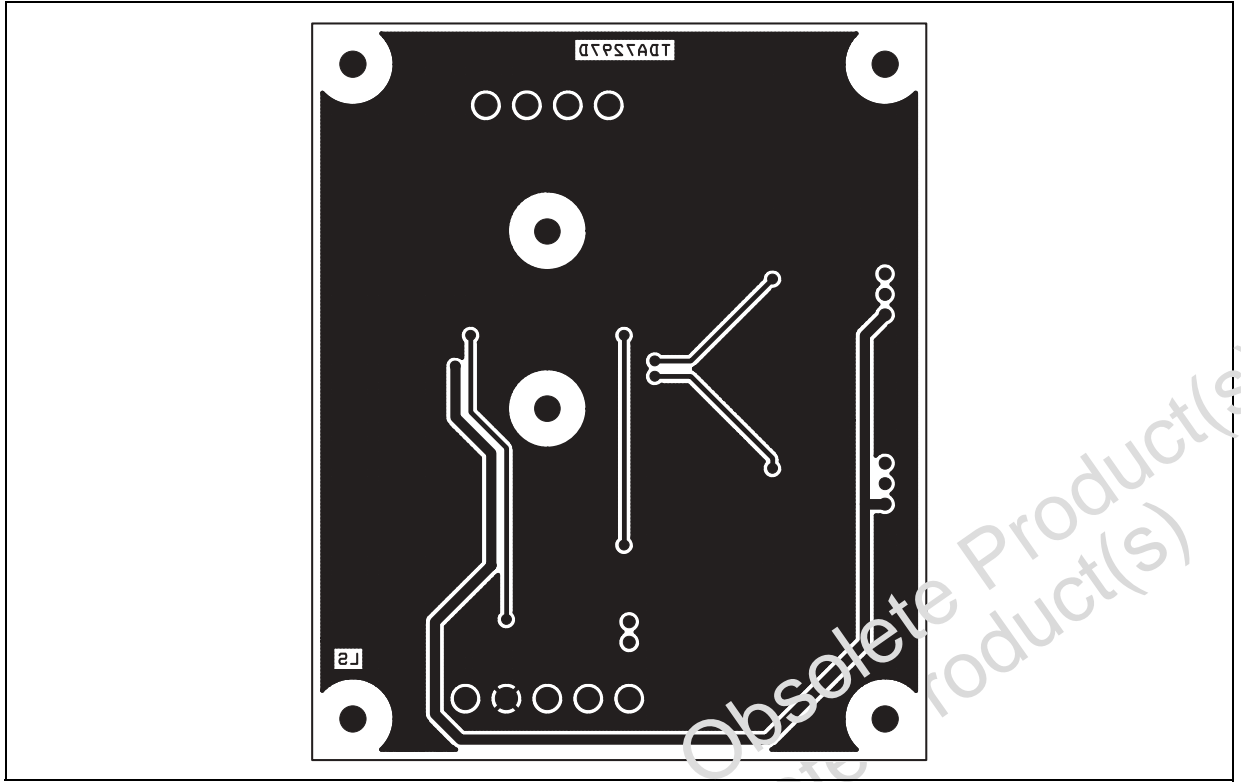
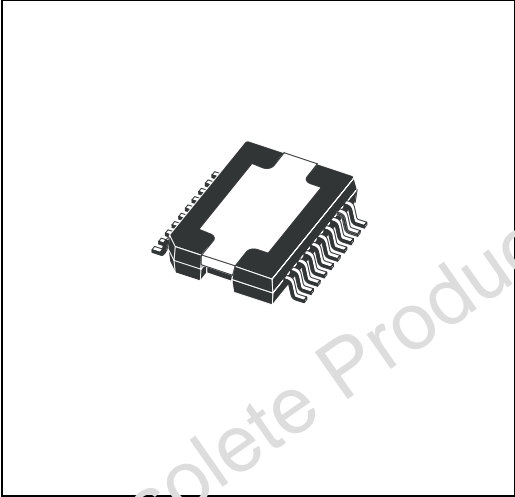

Figure 18. PowerSO20 (SLUG UP) Mechanical Data & Package Dimensions

DIM.	mm			inch		
	MIN.	TYP.	MAX.	MIN.	TYP.	MAX.
A	3.25		3.5	0.128		0.138
A2	3	3.15	3.3	0.118	0.124	0.130
A4	0.8		1	0.031		0.039
A5	0.15	0.2	0.25	0.006	0.008	0.010
a1	0.030		-0.040	0.0012		-0.0016
b	0.4		0.53	0.016		0.021
c	0.23		0.32	0.009		0.012
D (1)	15.8		16	0.622		0.630
D1	9.4		9.8	0.370		0.385
D2		1			0.039	
E	13.9		14.5	0.547		0.570
E1 (1)	10.9		11.1	0.429		0.437
E2			2.9			0.114
E3	5.8		6.2	0.228		0.244
e	1.12	1.27	1.42	0.044	0.050	0.056
e3		11.43			0.450	
G	0		0.1	0		0.004
H	15.5		15.9	0.61		0.625
h			1.1			0.043
L	0.8		1.1	0.031		0.043
N	10 _i (max)					
R		0.6			0.024	
S	0 _i (min.) 8 _j (max.)					
V	5 _i (min.) 7 _j (max.)					

OUTLINE AND MECHANICAL DATA



PowerSO20 (SLUG UP)

- (1) OD and $E1$ do not include mold flash or protrusions.
- Mold flash or protrusions shall not exceed 0.15mm (0.0060)
- Critical dimensions: E , A , D , E , e and D .

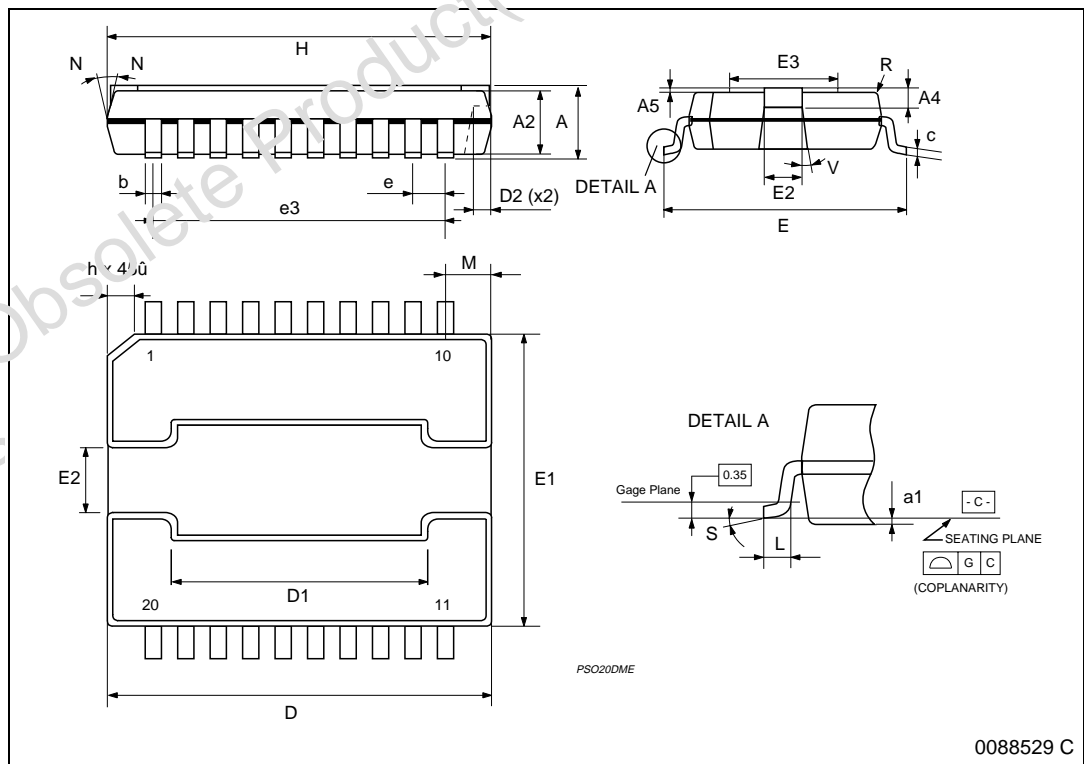

Table 5. Revision History

Date	Revision	Description of Changes
May 2004	1	First Issue

Obsolete Product(s) - Obsolete Product(s)
Obsolete Product(s) - Obsolete Product(s)

Information furnished is believed to be accurate and reliable. However, STMicroelectronics assumes no responsibility for the consequences of use of such information nor for any infringement of patents or other rights of third parties which may result from its use. No license is granted by implication or otherwise under any patent or patent rights of STMicroelectronics. Specifications mentioned in this publication are subject to change without notice. This publication supersedes and replaces all information previously supplied. STMicroelectronics products are not authorized for use as critical components in life support devices or systems without express written approval of STMicroelectronics.

The ST logo is a registered trademark of STMicroelectronics.
All other names are the property of their respective owners

© 2004 STMicroelectronics - All rights reserved

STMicroelectronics GROUP OF COMPANIES

Australia - Belgium - Brazil - Canada - China - Czech Republic - Finland - France - Germany - Hong Kong - India - Israel - Italy - Japan -
Malaysia - Malta - Morocco - Singapore - Spain - Sweden - Switzerland - United Kingdom - United States

www.st.com

Mouser Electronics

Authorized Distributor

Click to View Pricing, Inventory, Delivery & Lifecycle Information:

[STMicroelectronics:](#)

[TDA7297D](#) [TDA7297D13TR](#)