

TS78M00 Series

3-Terminal 500mA Positive Voltage Regulator

TS78M05 Electrical Characteristics

($V_{in}=10V$, $I_{out}=350mA$, $0^{\circ}C \leq T_j \leq 125^{\circ}C$, $C_{in}=0.33\mu F$, $C_{out}=0.1\mu F$; unless otherwise specified.)

Parameter	Symbol	Test Condition	Min	Typ	Max	Unit	
Output voltage	Vout	$T_j=25^{\circ}C$	4.80	5	5.20	V	
		$7.5V \leq V_{in} \leq 20V$, $5mA \leq I_{out} \leq 350mA$	4.75	5	5.25		
Line Regulation	REGline	$T_j=25^{\circ}C$	$7.5V \leq V_{in} \leq 25V$	--	3	100	mV
			$8V \leq V_{in} \leq 12V$	--	1	50	
Load Regulation	REGload	$T_j=25^{\circ}C$	$5mA \leq I_{out} \leq 500mA$	--	15	100	
			$5mA \leq I_{out} \leq 200mA$	--	5	50	
Quiescent Current	Iq	$I_{out}=0$, $T_j=25^{\circ}C$	--	3	6	mA	
Quiescent Current Change	ΔIq	$7.5V \leq V_{in} \leq 25V$	--	--	0.8		
		$5mA \leq I_{out} \leq 350mA$	--	--	0.5		
Output Noise Voltage	Vn	$10Hz \leq f \leq 100KHz$, $T_j=25^{\circ}C$	--	40	--	μV	
Ripple Rejection Ratio	RR	$f=120Hz$, $8V \leq V_{in} \leq 18V$	62	78	--	dB	
Voltage Drop	Vdrop	$I_{out}=500mA$, $T_j=25^{\circ}C$	--	2	--	V	
Output Resistance	Rout	$f=1KHz$	--	17	--	$m\Omega$	
Output Short Circuit Current	Ios	$T_j=25^{\circ}C$	--	50	--	mA	
Peak Output Current	I _{o peak}	$T_j=25^{\circ}C$	--	0.7	--	A	
Temperature Coefficient of Output Voltage	$\Delta V_{out} / \Delta T_j$	$I_{out}=5mA$, $0^{\circ}C \leq T_j \leq 125^{\circ}C$	--	-0.2	--	$mV / ^{\circ}C$	

TS78M06 Electrical Characteristics

($V_{in}=11V$, $I_{out}=350mA$, $0^{\circ}C \leq T_j \leq 125^{\circ}C$, $C_{in}=0.33\mu F$, $C_{out}=0.1\mu F$; unless otherwise specified.)

Parameter	Symbol	Test Condition	Min	Typ	Max	Unit	
Output Voltage	Vout	$T_j=25^{\circ}C$	5.75	6	6.25	V	
		$8.5V \leq V_{in} \leq 21V$, $5mA \leq I_{out} \leq 350mA$	5.7	6	6.3		
Line Regulation	REGline	$T_j=25^{\circ}C$	$8.5V \leq V_{in} \leq 25V$	--	5	120	mV
			$9V \leq V_{in} \leq 13V$	--	1.5	60	
Load Regulation	REGload	$T_j=25^{\circ}C$	$5mA \leq I_{out} \leq 500mA$	--	14	120	
			$5mA \leq I_{out} \leq 200mA$	--	4	60	
Quiescent Current	Iq	$I_{out}=0$, $T_j=25^{\circ}C$	--	3	6	mA	
Quiescent Current Change	ΔIq	$8.5V \leq V_{in} \leq 25V$	--	--	0.8		
		$5mA \leq I_{out} \leq 350mA$	--	--	0.5		
Output Noise Voltage	Vn	$10Hz \leq f \leq 100KHz$, $T_j=25^{\circ}C$	--	45	--	μV	
Ripple Rejection Ratio	RR	$F=120Hz$, $9V \leq V_{in} \leq 19V$	59	80	--	dB	
Voltage Drop	Vdrop	$I_{out}=500mA$, $T_j=25^{\circ}C$	--	2	--	V	
Output Resistance	Rout	$F=1KHz$	--	19	--	$m\Omega$	
Output Short Circuit Current	Ios	$T_j=25^{\circ}C$	--	50	--	mA	
Peak Output Current	I _{o peak}	$T_j=25^{\circ}C$	--	0.7	--	A	
Temperature Coefficient of Output Voltage	$\Delta V_{out} / \Delta T_j$	$I_{out}=5mA$, $0^{\circ}C \leq T_j \leq 125^{\circ}C$	--	-0.2	--	$mV / ^{\circ}C$	

- Pulse testing techniques are used to maintain the junction temperature as close to the ambient temperature as possible, and thermal effects must be taken into account separately.
- This specification applies only for DC power dissipation permitted by absolute maximum ratings.

TS78M08 Electrical Characteristics

$V_{in}=14V$, $I_{out}=350mA$, $0^{\circ}C \leq T_j \leq 125^{\circ}C$, $C_{in}=0.33\mu F$, $C_{out}=0.1\mu F$; unless otherwise specified.)

Parameter	Symbol	Test Condition	Min	Typ	Max	Unit	
Output voltage	Vout	$T_j=25^{\circ}C$	7.69	8	8.32	V	
		$10.5V \leq V_{in} \leq 23V$, $5mA \leq I_{out} \leq 350mA$	7.61	8	8.40		
Line Regulation	REGline	$T_j=25^{\circ}C$	$10.5V \leq V_{in} \leq 25V$	--	6	160	mV
			$11V \leq V_{in} \leq 17V$	--	2	80	
Load Regulation	REGload	$T_j=25^{\circ}C$	$5mA \leq I_{out} \leq 500mA$	--	12	160	
			$5mA \leq I_{out} \leq 200mA$	--	4	80	
Quiescent Current	Iq	$I_{out}=0$, $T_j=25^{\circ}C$	--	3	6	mA	
Quiescent Current Change	ΔIq	$10.5V \leq V_{in} \leq 25V$	--	--	0.8		
		$5mA \leq I_{out} \leq 350mA$	--	--	0.5		
Output Noise Voltage	Vn	$10Hz \leq f \leq 100KHz$, $T_j=25^{\circ}C$	--	52	--	μV	
Ripple Rejection Ratio	RR	$f=120Hz$, $11V \leq V_{in} \leq 21V$	56	80	--	dB	
Voltage Drop	Vdrop	$I_{out}=500mA$, $T_j=25^{\circ}C$	--	2	--	V	
Output Resistance	Rout	$f=1KHz$	--	16	--	$m\Omega$	
Output Short Circuit Current	Ios	$T_j=25^{\circ}C$	--	50	--	mA	
Peak Output Current	I _{o peak}	$T_j=25^{\circ}C$	--	0.7	--	A	
Temperature Coefficient of Output Voltage	$\Delta V_{out}/\Delta T_j$	$I_{out}=5mA$, $0^{\circ}C \leq T_j \leq 125^{\circ}C$	--	-0.2	--	$mV/^{\circ}C$	

TS78M09 Electrical Characteristics

$V_{in}=15V$, $I_{out}=350mA$, $0^{\circ}C \leq T_j \leq 125^{\circ}C$, $C_{in}=0.33\mu F$, $C_{out}=0.1\mu F$; unless otherwise specified.)

Parameter	Symbol	Test Condition	Min	Typ	Max	Unit	
Output Voltage	Vout	$T_j=25^{\circ}C$	8.65	9	9.36	V	
		$11.5V \leq V_{in} \leq 23V$, $5mA \leq I_{out} \leq 350mA$	8.57	9	9.45		
Line Regulation	REGline	$T_j=25^{\circ}C$	$11.5V \leq V_{in} \leq 26V$	--	6	180	mV
			$12V \leq V_{in} \leq 17V$	--	2	90	
Load Regulation	REGload	$T_j=25^{\circ}C$	$5mA \leq I_{out} \leq 500mA$	--	12	180	
			$5mA \leq I_{out} \leq 200mA$	--	4	90	
Quiescent Current	Iq	$I_{out}=0$, $T_j=25^{\circ}C$	--	3	6	mA	
Quiescent Current Change	ΔIq	$11.5V \leq V_{in} \leq 26V$	--	--	0.8		
		$5mA \leq I_{out} \leq 350mA$	--	--	0.5		
Output Noise Voltage	Vn	$10Hz \leq f \leq 100KHz$, $T_j=25^{\circ}C$	--	52	--	μV	
Ripple Rejection Ratio	RR	$f=120Hz$, $12V \leq V_{in} \leq 22V$	55	80	--	dB	
Voltage Drop	Vdrop	$I_{out}=500mA$, $T_j=25^{\circ}C$	--	2	--	V	
Output Resistance	Rout	$f=1KHz$	--	16	--	$m\Omega$	
Output Short Circuit Current	Ios	$T_j=25^{\circ}C$	--	50	--	mA	
Peak Output Current	I _{o peak}	$T_j=25^{\circ}C$	--	0.7	--	A	
Temperature Coefficient of Output Voltage	$\Delta V_{out}/\Delta T_j$	$I_{out}=5mA$, $0^{\circ}C \leq T_j \leq 125^{\circ}C$	--	-0.2	--	$mV/^{\circ}C$	

- Pulse testing techniques are used to maintain the junction temperature as close to the ambient temperature as possible, and thermal effects must be taken into account separately.
- This specification applies only for DC power dissipation permitted by absolute maximum ratings.

TS78M00 Series

3-Terminal 500mA Positive Voltage Regulator

TS78M12 Electrical Characteristics

($V_{in}=19V$, $I_{out}=350mA$, $0^{\circ}C \leq T_j \leq 125^{\circ}C$, $C_{in}=0.33\mu F$, $C_{out}=0.1\mu F$; unless otherwise specified.)

Parameter	Symbol	Test Condition	Min	Typ	Max	Unit	
Output Voltage	Vout	$T_j=25^{\circ}C$	11.53	12	12.48	V	
		$14.5V \leq V_{in} \leq 27V$, $5mA \leq I_{out} \leq 350mA$	11.42	12	12.60		
Line Regulation	REGline	$T_j=25^{\circ}C$	$14.5V \leq V_{in} \leq 30V$	--	10	240	mV
			$15V \leq V_{in} \leq 19V$	--	3	120	
Load Regulation	REGload	$T_j=25^{\circ}C$	$5mA \leq I_{out} \leq 500mA$	--	12	240	
			$5mA \leq I_{out} \leq 200mA$	--	4	120	
Quiescent Current	Iq	$T_j=25^{\circ}C$, $I_{out}=0$	--	3	6	mA	
Quiescent Current Change	ΔIq	$14.5V \leq V_{in} \leq 30V$ $5mA \leq I_{out} \leq 500mA$	--	--	0.8		
			--	--	0.5		
Output Noise Voltage	Vn	$10Hz \leq f \leq 100KHz$, $T_j=25^{\circ}C$	--	75	--	μV	
Ripple Rejection Ratio	RR	$f=120Hz$, $15V \leq V_{in} \leq 25V$	55	80	--	dB	
Voltage Drop	Vdrop	$I_{out}=500mA$, $T_j=25^{\circ}C$	--	2	--	V	
Output Resistance	Rout	$f=1KHz$	--	18	--	$m\Omega$	
Output Short Circuit Current	Ios	$T_j=25^{\circ}C$	--	50	--	mA	
Peak Output Current	I _{o peak}	$T_j=25^{\circ}C$	--	0.7	--	A	
Temperature Coefficient of Output Voltage	$\Delta V_{out} / \Delta T_j$	$I_{out}=5mA$, $0^{\circ}C \leq T_j \leq 125^{\circ}C$	--	-0.3	--	mV/ $^{\circ}C$	

TS78M15 Electrical Characteristics

($V_{in}=23V$, $I_{out}=350mA$, $0^{\circ}C \leq T_j \leq 125^{\circ}C$, $C_{in}=0.33\mu F$, $C_{out}=0.1\mu F$; unless otherwise specified.)

Parameter	Symbol	Test Condition	Min	Typ	Max	Unit	
Output voltage	Vout	$T_j=25^{\circ}C$	14.42	15	15.60	V	
		$17.5V \leq V_{in} \leq 30V$, $5mA \leq I_{out} \leq 350mA$	14.28	15	15.75		
Line Regulation	REGline	$T_j=25^{\circ}C$	$17.5V \leq V_{in} \leq 30V$	--	12	300	mV
			$18V \leq V_{in} \leq 22V$	--	3	150	
Load Regulation	REGload	$T_j=25^{\circ}C$	$5mA \leq I_{out} \leq 500mA$	--	12	300	
			$5mA \leq I_{out} \leq 200mA$	--	4	150	
Quiescent Current	Iq	$T_j=25^{\circ}C$, $I_{out}=0$	--	3	6	mA	
Quiescent Current Change	ΔIq	$17.5V \leq V_{in} \leq 30V$ $5mA \leq I_{out} \leq 500mA$	--	--	0.8		
			--	--	0.5		
Output Noise Voltage	Vn	$10Hz \leq f \leq 100KHz$, $T_j=25^{\circ}C$	--	90	--	μV	
Ripple Rejection Ratio	RR	$f=120Hz$, $18V \leq V_{in} \leq 28V$	54	80	--	dB	
Voltage Drop	Vdrop	$I_{out}=500mA$, $T_j=25^{\circ}C$	--	2	--	V	
Output Resistance	Rout	$f=1KHz$	--	19	--	$m\Omega$	
Output Short Circuit Current	Ios	$T_j=25^{\circ}C$	--	50	--	mA	
Peak Output Current	I _{o peak}	$T_j=25^{\circ}C$	--	0.7	--	A	
Temperature Coefficient of Output Voltage	$\Delta V_{out} / \Delta T_j$	$I_{out}=10mA$, $0^{\circ}C \leq T_j \leq 125^{\circ}C$	--	-0.3	--	mV/ $^{\circ}C$	

- Pulse testing techniques are used to maintain the junction temperature as close to the ambient temperature as possible, and thermal effects must be taken into account separately.
- This specification applies only for DC power dissipation permitted by absolute maximum ratings.

TS78M18 Electrical Characteristics

($V_{in}=24V$, $I_{out}=350mA$, $0^{\circ}C \leq T_j \leq 125^{\circ}C$, $C_{in}=0.33\mu F$, $C_{out}=0.1\mu F$; unless otherwise specified.)

Parameter	Symbol	Test Condition	Min	Typ	Max	Unit	
Output Voltage	Vout	$T_j=25^{\circ}C$	17.30	18	18.72	V	
		$21V \leq V_{in} \leq 33V$, $5mA \leq I_{out} \leq 350mA$	17.14	18	18.90		
Line Regulation	REGline	$T_j=25^{\circ}C$	$21V \leq V_{in} \leq 33V$	--	15	360	mV
			$22V \leq V_{in} \leq 26V$	--	5	180	
Load Regulation	REGload	$T_j=25^{\circ}C$	$5mA \leq I_{out} \leq 500mA$	--	12	360	
			$5mA \leq I_{out} \leq 200mA$	--	4	180	
Quiescent Current	Iq	$T_j=25^{\circ}C$, $I_{out}=0$	--	3	6	mA	
Quiescent Current Change	ΔIq	$21V \leq V_{in} \leq 33V$	--	--	0.8		
		$5mA \leq I_{out} \leq 500mA$	--	--	0.5		
Output Noise Voltage	Vn	$10Hz \leq f \leq 100KHz$, $T_j=25^{\circ}C$	--	110	--	μV	
Ripple Rejection Ratio	RR	$f=120Hz$, $21V \leq V_{in} \leq 31V$	54	80	--	dB	
Voltage Drop	Vdrop	$I_{out}=500mA$, $T_j=25^{\circ}C$	--	2	--	V	
Output Resistance	Rout	$f=1KHz$	--	22	--	$m\Omega$	
Output Short Circuit Current	Ios	$T_j=25^{\circ}C$	--	50	--	mA	
Peak Output Current	I _{o peak}	$T_j=25^{\circ}C$	--	0.7	--	A	
Temperature Coefficient of Output Voltage	$\Delta V_{out}/\Delta T_j$	$I_{out}=5mA$, $0^{\circ}C \leq T_j \leq 125^{\circ}C$	--	-0.5	--	$mV/^{\circ}C$	

TS78M24 Electrical Characteristics

($V_{in}=33V$, $I_{out}=350mA$, $0^{\circ}C \leq T_j \leq 125^{\circ}C$, $C_{in}=0.33\mu F$, $C_{out}=0.1\mu F$; unless otherwise specified.)

Parameter	Symbol	Test Condition	Min	Typ	Max	Unit	
Output voltage	Vout	$T_j=25^{\circ}C$	23.07	24	24.96	V	
		$27V \leq V_{in} \leq 38V$, $5mA \leq I_{out} \leq 350mA$	22.85	24	25.20		
Line Regulation	REGline	$T_j=25^{\circ}C$	$27V \leq V_{in} \leq 38V$	--	18	480	mV
			$28V \leq V_{in} \leq 32V$	--	6	240	
Load Regulation	REGload	$T_j=25^{\circ}C$	$5mA \leq I_{out} \leq 500mA$	--	12	480	
			$5mA \leq I_{out} \leq 200mA$	--	4	240	
Quiescent Current	Iq	$I_{out}=0$, $T_j=25^{\circ}C$	--	3	6	mA	
Quiescent Current Change	ΔIq	$27V \leq V_{in} \leq 38V$	--	--	0.8		
		$5mA \leq I_{out} \leq 500mA$	--	--	0.5		
Output Noise Voltage	Vn	$10Hz \leq f \leq 100KHz$, $T_j=25^{\circ}C$	--	170	--	μV	
Ripple Rejection Ratio	RR	$f=120Hz$, $27V \leq V_{in} \leq 37V$	54	80	--	dB	
Voltage Drop	Vdrop	$I_{out}=500mA$, $T_j=25^{\circ}C$	--	2	--	V	
Output Resistance	Rout	$f=1KHz$	--	28	--	$m\Omega$	
Output Short Circuit Current	Ios	$T_j=25^{\circ}C$	--	50	--	mA	
Peak Output Current	I _{o peak}	$T_j=25^{\circ}C$	--	0.7	--	A	
Temperature Coefficient of Output Voltage	$\Delta V_{out}/\Delta T_j$	$I_{out}=5mA$, $0^{\circ}C \leq T_j \leq 125^{\circ}C$	--	-0.5	--	$mV/^{\circ}C$	

- Pulse testing techniques are used to maintain the junction temperature as close to the ambient temperature as possible, and thermal effects must be taken into account separately.
- This specification applies only for DC power dissipation permitted by absolute maximum ratings.

Electrical Characteristics Curve

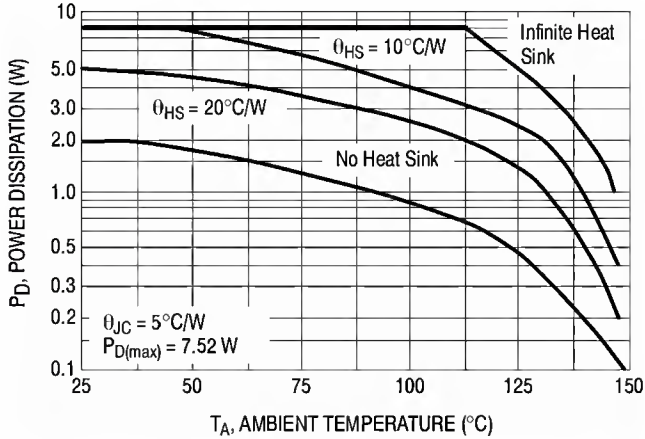

Figure 1. Worst Case Power Dissipation vs. Ambient Temperature (TO-220)

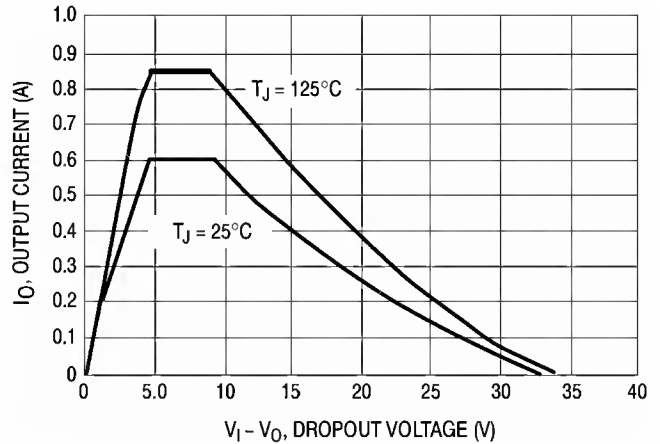

Figure 2. Peak Output Current vs. Dropout Voltage

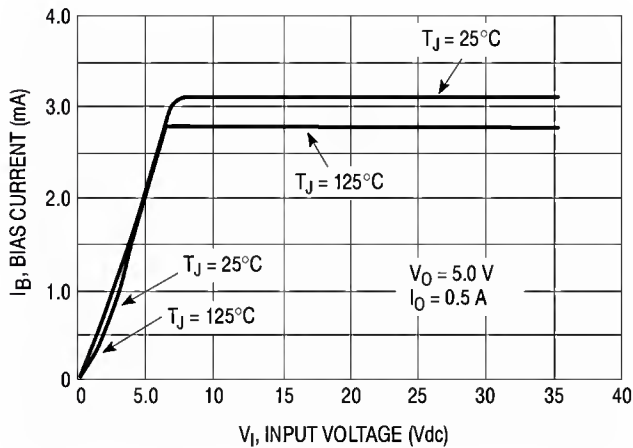

Figure 3. Bias Current vs. Input Voltage

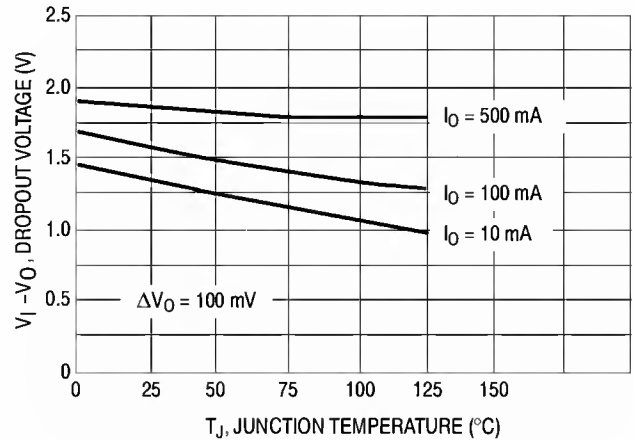

Figure 4. Dropout Voltage vs. Junction Temperature

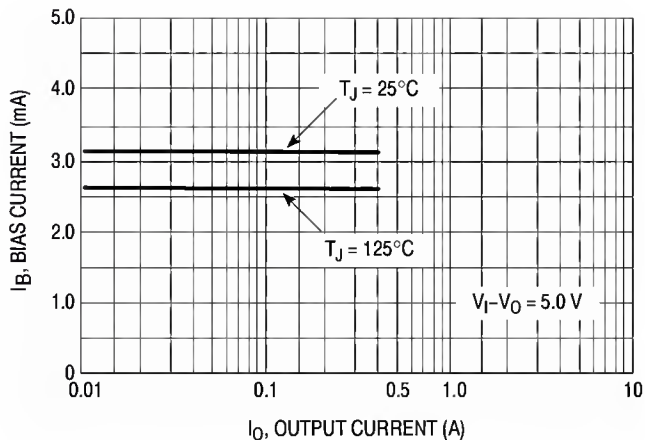

Figure 5. Bias Current vs. Output Current

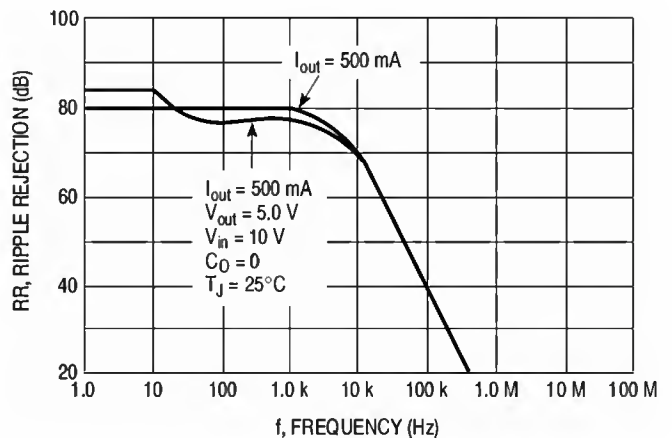

Figure 6. Ripple Rejection vs. Frequency

Application information

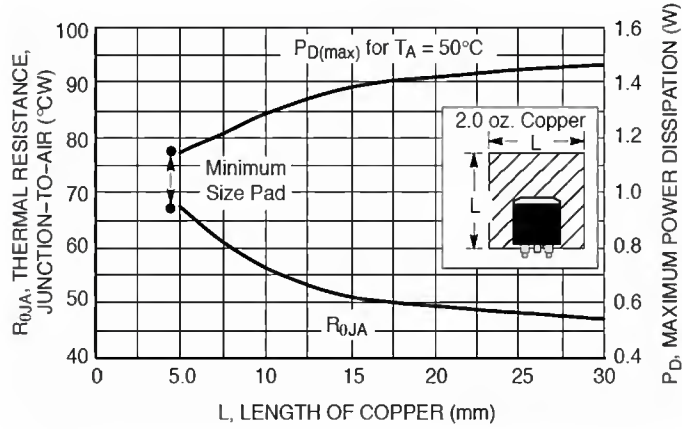
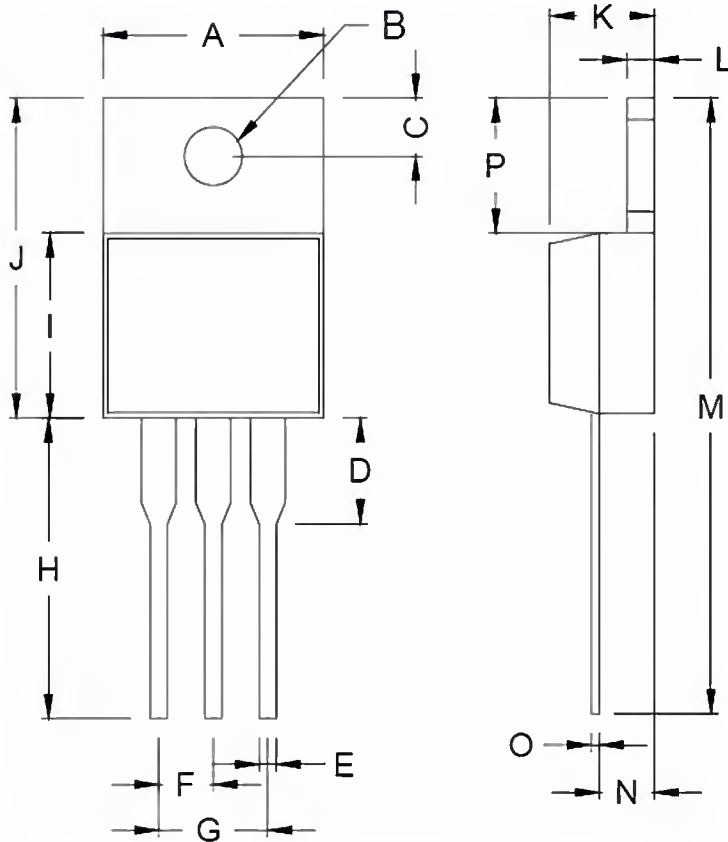

Figure 7. DPAK Thermal Resistance and Maximum Power Dissipation vs. P.C.B Copper Length

TO-220 Mechanical Drawing



TO-220 DIMENSION				
DIM	MILLIMETERS		INCHES	
	MIN	MAX	MIN	MAX
A	10.000	10.500	0.394	0.413
B	3.740	3.910	0.147	0.154
C	2.440	2.940	0.096	0.116
D	-	6.350	-	0.250
E	0.381	1.106	0.015	0.040
F	2.345	2.715	0.092	0.058
G	4.690	5.430	0.092	0.107
H	12.700	14.732	0.500	0.581
I	8.382	9.017	0.330	0.355
J	14.224	16.510	0.560	0.650
K	3.556	4.826	0.140	0.190
L	0.508	1.397	0.020	0.055
M	27.700	29.620	1.060	1.230
N	2.032	2.921	0.080	0.115
O	0.255	0.610	0.010	0.024
P	5.842	6.858	0.230	0.270

Marking Diagram

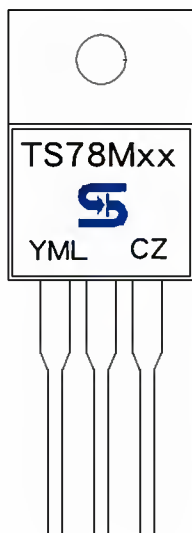

- XX** = Output Voltage
(05=5V, 08=8V, 09=9V, 12=12V, 15=15V, 18=18V, 24=24V)
- Y** = Year Code
- M** = Month Code
(A=Jan, B=Feb, C=Mar, D=Apr, E=May, F=Jun, G=Jul, H=Aug, I=Sep, J=Oct, K=Nov, L=Dec)
- L** = Lot Code
- CZ** = Package Code for TO-220

TO-252 Mechanical Drawing

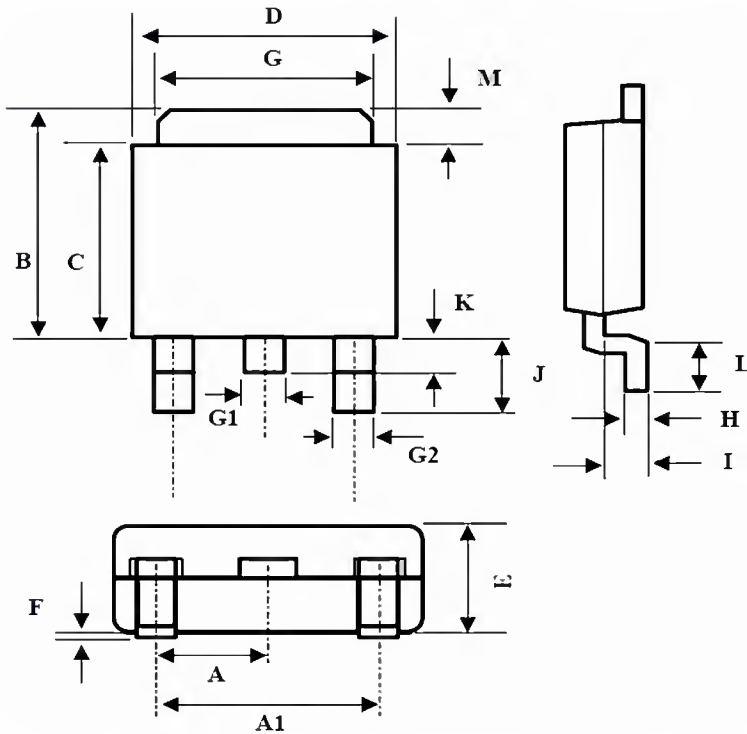

TO-252 DIMENSION				
DIM	MILLIMETERS		INCHES	
	MIN	MAX	MIN	MAX
A	2.3BSC		0.09BSC	
A1	4.6BSC		0.18BSC	
B	6.80	7.20	0.268	0.283
C	5.40	5.60	0.213	0.220
D	6.40	6.65	0.252	0.262
E	2.20	2.40	0.087	0.094
F	0.00	0.20	0.000	0.008
G	5.20	5.40	0.205	0.213
G1	0.75	0.85	0.030	0.033
G2	0.55	0.65	0.022	0.026
H	0.35	0.65	0.014	0.026
I	0.90	1.50	0.035	0.059
J	2.20	2.80	0.087	0.110
K	0.50	1.10	0.020	0.043
L	0.90	1.50	0.035	0.059
M	1.30	1.70	0.051	0.67

Marking Diagram

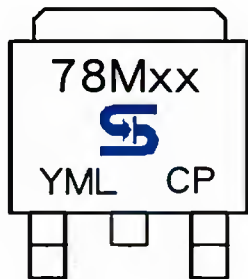

- XX** = Output Voltage
(05=5V, 08=8V, 09=9V, 12=12V, 15=15V, 18=18V, 24=24V)
- Y** = Year Code
- M** = Month Code
(A=Jan, B=Feb, C=Mar, D=Apl, E=May, F=Jun, G=Jul, H=Aug, I=Sep, J=Oct, K=Nov, L=Dec)
- L** = Lot Code
- CP** = Package Code for TO-252

TS78M00 Series

3-Terminal 500mA Positive Voltage Regulator

Notice

Specifications of the products displayed herein are subject to change without notice. TSC or anyone on its behalf, assumes no responsibility or liability for any errors or inaccuracies.

Information contained herein is intended to provide a product description only. No license, express or implied, to any intellectual property rights is granted by this document. Except as provided in TSC's terms and conditions of sale for such products, TSC assumes no liability whatsoever, and disclaims any express or implied warranty, relating to sale and/or use of TSC products including liability or warranties relating to fitness for a particular purpose, merchantability, or infringement of any patent, copyright, or other intellectual property right.

The products shown herein are not designed for use in medical, life-saving, or life-sustaining applications. Customers using or selling these products for use in such applications do so at their own risk and agree to fully indemnify TSC for any damages resulting from such improper use or sale.