

Dimensions

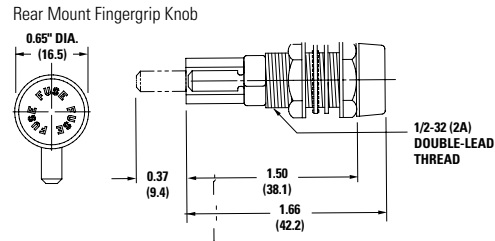

Part Numbering System

Part Number		Knob Type	Low Profile	High Profile	Front Mount	Rear Mount	Rt. Angle Terminal	Straight Terminal	Packing
(3AG/AB)	5x20mm								
03450601H	03450621H	Screwdriver Slot	X	-	X	-	X	-	Bulk (100 pieces)
03450602H	03450622H	Screwdriver Slot	-	X	X	-	X	-	Bulk (100 pieces)
03450603H	03450623H	Finger Grip	-	X	X	-	X	-	Bulk (100 pieces)
03450611H	03450631H	Screwdriver Slot	X	-	X	-	-	X	Bulk (100 pieces)
03450612H	03450632H	Screwdriver Slot	-	X	X	-	-	X	Bulk (100 pieces)
03450613H	03450633H	Finger Grip	-	X	X	-	-	X	Bulk (100 pieces)
03450701H	--	Screwdriver Slot	X	-	X	-	X	-	Bulk (100 pieces)
03450711H	--	Screwdriver Slot	X	-	X	-	-	X	Bulk (100 pieces)
03450903H	03450923H	Finger Grip	-	X	-	X	X	-	Bulk (100 pieces)
03450913H	03450933H	Finger Grip	-	X	-	X	-	X	Bulk (100 pieces)

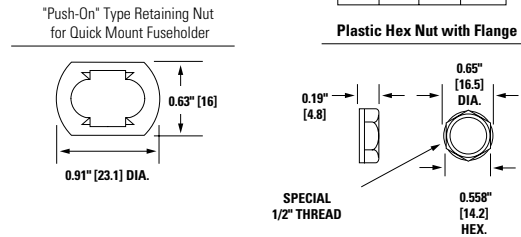
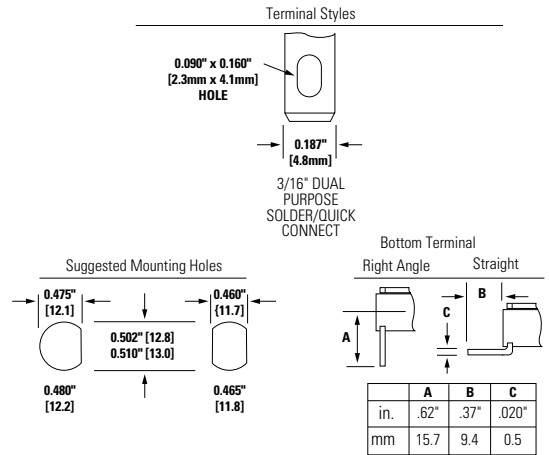
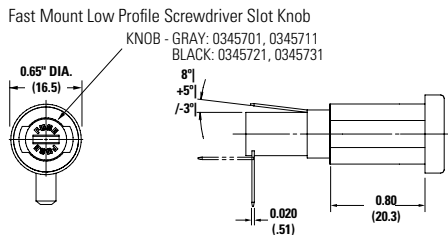
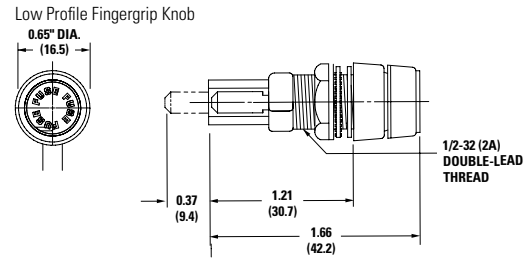
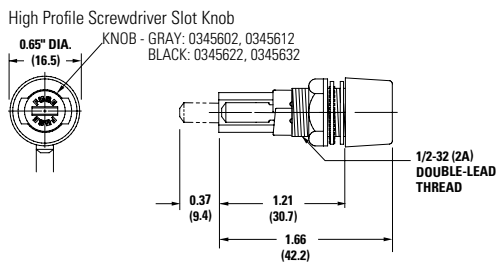
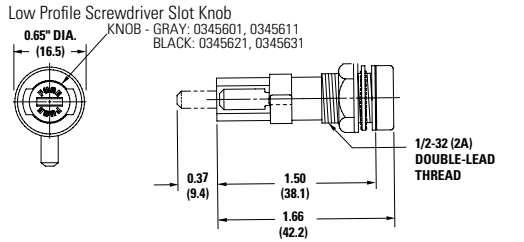

345 HV Series Shock Safe Circuit Board Mount Enclosed Fuse Holders     



Product Characteristics

Compatible Fuse Types	3AG 3AB 5x20mm
Description	Similar to our Shock-Safe panel mount fuseholders, this series is designed per IEC Standards 60127-6. Two different knob styles available are available for use with 3AG and 3AB (¼" × 1¼") or 5 × 20mm fuses.
Electrical	Insulation Resistance: 10,000 megohm minimum at 500 VDC. Contact Resistance: Less than .005 ohm average at a current of one ampere.
Dielectric Strength	4000 volts minimum. Mounting: Intended for soldering to printed circuit boards.
Molded Parts	Body Material: Black glass-filled thermoplastic (UL 94V0).
Knob	Screwdriver slot, fuse extractor type with nickel-plated, copper alloy insert. Spring-loaded, bayonet style. Knob Material: Grey or Black glass-filled thermoplastic (UL94 V-0)
Terminals	Brass. Tin-plated.
Ambient Temperature	-40°C to +85°C.

Agency Approvals

Agency	Agency File Number
	E14721
	7316
	133923

* Please refer to Fuseology section for information on proper fuseholder re-rating.

Ordering Information

Ordering Part Number	Catalog Number	Fuse Size	Packing
03450101H	345 101	¼" × 1¼" Fuses	Bulk (100 pieces)
03450121H	345 121	5 × 20mm Fuses	Bulk (100 pieces)

Body only: 03450101HX010
Knob only: 03450101HX020 (¼" × 1¼") Grey; 03450121HX020 (5 × 20mm) Black.

Dimensions

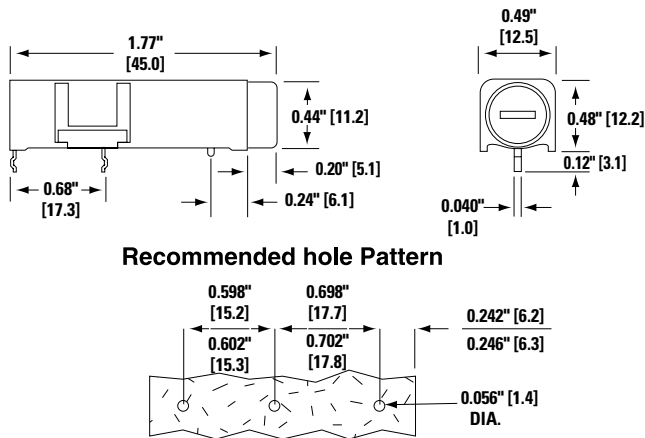

Disclaimer Notice - Information furnished is believed to be accurate and reliable. However, users should independently evaluate the suitability of and test each product selected for their own applications. Littelfuse products are not designed for, and may not be used in, all applications. Read complete Disclaimer Notice at: www.littelfuse.com/disclaimer-electronics

Mouser Electronics

Authorized Distributor

Click to View Pricing, Inventory, Delivery & Lifecycle Information:

Littelfuse:

[345923](#) [345603](#) [345601-020](#) [345602](#) [345621](#) [345621-020](#) [345623-020](#) [571008](#) [03450601ZX010](#) [345101](#)
[345121](#) [345121-02](#) [345601](#) [345613](#) [345933](#) [571007P](#) [345933A](#) [03450623HX020](#) [03450632X](#) [03450613H](#)
[03450612X](#) [03450903X](#) [03450101X](#) [03450701ZX010](#) [03450603HX020](#) [03450612ZX010](#) [03450101HX010](#)
[03450913X](#) [03450933X](#) [03450923X](#) [03450711ZX010](#) [03450913H](#) [03450612H](#) [03450621H](#) [03450623X](#)
[03450101HX020](#) [03450613ZX010](#) [03450711X](#) [03450611H](#) [03450121X](#) [03450913ZX010](#) [03450613X](#) [03450631X](#)
[03450633H](#) [03450711H](#) [03450602ZX010](#) [03450603H](#) [03450611X](#) [03450603X](#) [03450121HX020](#) [03450601X](#)
[03450611ZX010](#) [03450622X](#) [03450923H](#) [03450602H](#) [03450933H](#) [03450623H](#) [03450101H](#) [03450601HX020](#)
[03450631H](#) [03450633X](#) [03450601H](#) [03450622H](#) [03450121H](#) [03450621X](#) [03450701H](#) [03450903H](#) [345611](#)
[03450701X](#) [03450903ZX010](#) [03450621HX020](#) [345903](#) [03450632H](#) [03450603HX040](#) [03450613HX040](#)