



# Single/Dual/Quad, Micropower, Single-Supply Rail-to-Rail Op Amps

MAX492/MAX494/MAX495

## General Description

The dual MAX492, quad MAX494, and single MAX495 operational amplifiers combine excellent DC accuracy with rail-to-rail operation at the input and output. Since the common-mode voltage extends from  $V_{CC}$  to  $V_{EE}$ , the devices can operate from either a single supply (+2.7V to +6V) or split supplies ( $\pm 1.35V$  to  $\pm 3V$ ). Each op amp requires less than 150 $\mu A$  supply current. Even with this low current, the op amps are capable of driving a 1k $\Omega$  load, and the input referred voltage noise is only 25nV/ $\sqrt{Hz}$ . In addition, these op amps can drive loads in excess of 1nF.

The precision performance of the MAX492/MAX494/MAX495, combined with their wide input and output dynamic range, low-voltage single-supply operation, and very low supply current, makes them an ideal choice for battery-operated equipment and other low-voltage applications. The MAX492/MAX494/MAX495 are available in DIP and SO packages in the industry-standard op-amp pin configurations. The MAX495 is also available in the smallest 8-pin SO: the  $\mu$ MAX package.

## Applications

- Portable Equipment
- Battery-Powered Instruments
- Data Acquisition
- Signal Conditioning
- Low-Voltage Applications

## Typical Operating Circuit

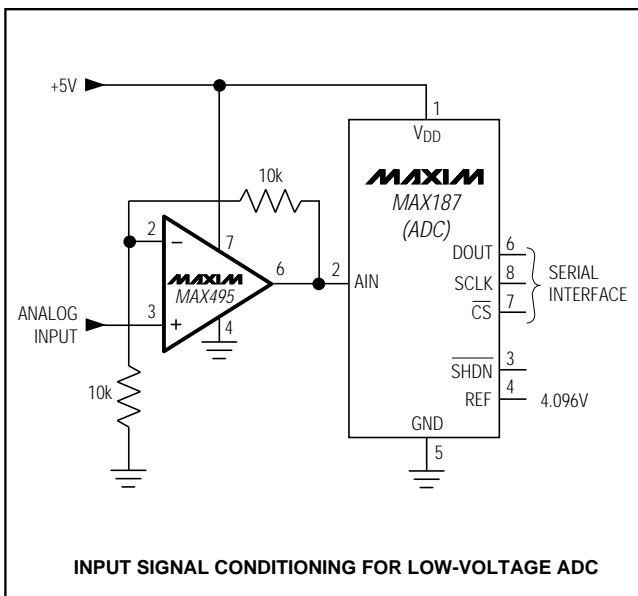

## Features

- ◆ Low-Voltage Single-Supply Operation (+2.7V to +6V)
- ◆ Rail-to-Rail Input Common-Mode Voltage Range
- ◆ Rail-to-Rail Output Swing
- ◆ 500kHz Gain-Bandwidth Product
- ◆ Unity-Gain Stable
- ◆ 150 $\mu A$  Max Quiescent Current per Op Amp
- ◆ No Phase Reversal for Overdriven Inputs
- ◆ 200 $\mu V$  Offset Voltage
- ◆ High Voltage Gain (108dB)
- ◆ High CMRR (90dB) and PSRR (110dB)
- ◆ Drives 1k $\Omega$  Load
- ◆ Drives Large Capacitive Loads
- ◆ MAX495 Available in  $\mu$ MAX Package—8-Pin SO

## Ordering Information

PART	TEMP. RANGE	PIN-PACKAGE
MAX492CPA	0°C to +70°C	8 Plastic DIP
MAX492CSA	0°C to +70°C	8 SO
MAX492C/D	0°C to +70°C	Dice*
MAX492EPA	-40°C to +85°C	8 Plastic DIP
MAX492ESA	-40°C to +85°C	8 SO
MAX492MJA	-55°C to +125°C	8 CERDIP

**Ordering Information continued at end of data sheet.**  
 \*Dice are specified at  $T_A = +25^\circ C$ , DC parameters only.

## Pin Configurations

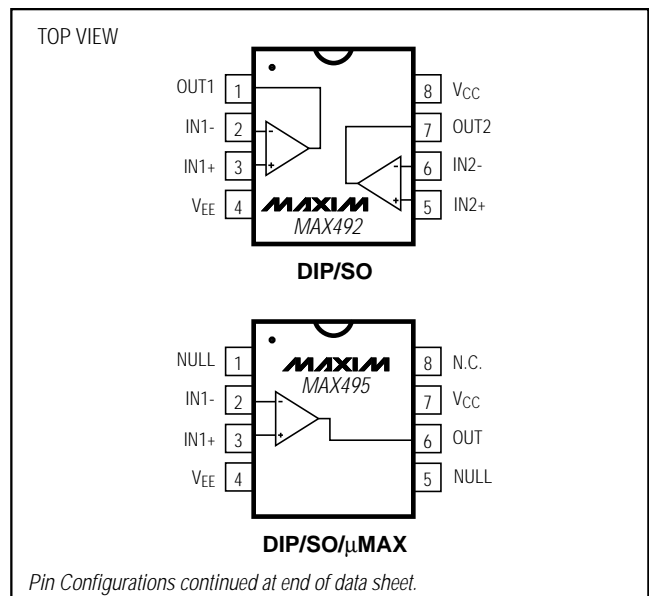

# Single/Dual/Quad, Micropower, Single-Supply Rail-to-Rail Op Amps

## ABSOLUTE MAXIMUM RATINGS

Supply Voltage ( $V_{CC}$ to $V_{EE}$ )	7V	14-Pin Plastic DIP (derate 10.00mW/°C above +70°C)	800mW
Common-Mode Input Voltage	( $V_{CC} + 0.3V$ ) to ( $V_{EE} - 0.3V$ )	14-Pin SO (derate 8.33mW/°C above +70°C)	667mW
Differential Input Voltage	$\pm(V_{CC} - V_{EE})$	14-Pin CERDIP (derate 9.09mW/°C above +70°C)	727mW
Input Current ( $I_{N+}$ , $I_{N-}$ , $I_{NULL1}$ , $I_{NULL2}$ )	$\pm 10mA$	Operating Temperature Ranges	
Output Short-Circuit Duration	Indefinite short circuit to either supply	MAX49_C_ _	0°C to +70°C
Voltage Applied to NULL Pins	$V_{CC}$ to $V_{EE}$	MAX49_E_ _	-40°C to +85°C
Continuous Power Dissipation ( $T_A = +70^\circ C$ )		MAX49_M_ _	-55°C to +125°C
8-Pin Plastic DIP (derate 9.09mW/°C above +70°C)	727mW	Junction Temperatures	
8-Pin SO (derate 5.88mW/°C above +70°C)	471mW	MAX49_C_ _/E_ _	+150°C
8-Pin CERDIP (derate 8.00mW/°C above +70°C)	640mW	MAX49_M_ _	+175°C
8-Pin $\mu$ MAX (derate 4.1mW/°C above +70°C)	330mW	Storage Temperature Range	
		-65°C to +150°C	
		Lead Temperature (soldering, 10sec)	
		+300°C	

Stresses beyond those listed under "Absolute Maximum Ratings" may cause permanent damage to the device. These are stress ratings only, and functional operation of the device at these or any other conditions beyond those indicated in the operational sections of the specifications is not implied. Exposure to absolute maximum rating conditions for extended periods may affect device reliability.

## DC ELECTRICAL CHARACTERISTICS

( $V_{CC} = 2.7V$  to  $6V$ ,  $V_{EE} = GND$ ,  $V_{CM} = 0V$ ,  $V_{OUT} = V_{CC} / 2$ ,  $T_A = +25^\circ C$ , unless otherwise noted.)

PARAMETER	CONDITIONS		MIN	TYP	MAX	UNITS
Input Offset Voltage	$V_{CM} = V_{EE}$ to $V_{CC}$			$\pm 200$	$\pm 500$	$\mu V$
Input Bias Current	$V_{CM} = V_{EE}$ to $V_{CC}$			$\pm 25$	$\pm 60$	nA
Input Offset Current	$V_{CM} = V_{EE}$ to $V_{CC}$			$\pm 0.5$	$\pm 6$	nA
Differential Input Resistance				2		M $\Omega$
Common-Mode Input Voltage Range			$V_{EE} - 0.25$		$V_{CC} + 0.25$	V
Common-Mode Rejection Ratio	$(V_{EE} - 0.25V) \leq V_{CM} \leq (V_{CC} + 0.25V)$		74	90		dB
Power-Supply Rejection Ratio	$V_{CC} = 2.7V$ to $6V$		88	110		dB
Large-Signal Voltage Gain (Note 1)	$V_{CC} = 2.7V$ , $R_L = 100k\Omega$ , $V_{OUT} = 0.25V$ to $2.45V$	Sourcing	90	104		dB
		Sinking	90	102		
	$V_{CC} = 2.7V$ , $R_L = 1k\Omega$ , $V_{OUT} = 0.5V$ to $2.2V$	Sourcing	94	105		
		Sinking	78	90		
	$V_{CC} = 5.0V$ , $R_L = 100k\Omega$ , $V_{OUT} = 0.25V$ to $4.75V$	Sourcing	98	108		
		Sinking	92	100		
$V_{CC} = 5.0V$ , $R_L = 1k\Omega$ , $V_{OUT} = 0.5V$ to $4.5V$	Sourcing	98	110			
	Sinking	86	98			
Output Voltage Swing (Note 1)	$R_L = 100k\Omega$	$V_{OH}$	$V_{CC} - 0.075$	$V_{CC} - 0.04$		V
		$V_{OL}$		$V_{EE} + 0.04$	$V_{EE} + 0.075$	
	$R_L = 1k\Omega$	$V_{OH}$	$V_{CC} - 0.20$	$V_{CC} - 0.15$		
		$V_{OL}$		$V_{EE} + 0.15$	$V_{EE} + 0.20$	
Output Short-Circuit Current				30		mA
Operating Supply Voltage Range			2.7		6.0	V
Supply Current (per amplifier)	$V_{CM} = V_{OUT} = V_{CC} / 2$	$V_{CC} = 2.7V$		135	150	$\mu A$
		$V_{CC} = 5V$		150	170	

# Single/Dual/Quad, Micropower, Single-Supply Rail-to-Rail Op Amps

MAX492/MAX494/MAX495

## AC ELECTRICAL CHARACTERISTICS

( $V_{CC} = 2.7V$  to  $6V$ ,  $V_{EE} = GND$ ,  $T_A = +25^{\circ}C$ , unless otherwise noted.)

PARAMETER	CONDITIONS	MIN	TYP	MAX	UNITS
Gain-Bandwidth Product	$R_L = 100k\Omega$ , $C_L = 100pF$		500		kHz
Phase Margin	$R_L = 100k\Omega$ , $C_L = 100pF$		60		degrees
Gain Margin	$R_L = 100k\Omega$ , $C_L = 100pF$		10		dB
Total Harmonic Distortion	$R_L = 10k\Omega$ , $C_L = 15pF$ , $V_{OUT} = 2V_{p-p}$ , $A_V = +1$ , $f = 1kHz$		0.003		%
Slew Rate	$R_L = 100k\Omega$ , $C_L = 15pF$		0.20		V/ $\mu s$
Time	To 0.1%, 2V step		12		$\mu s$
Turn-On Time	$V_{CC} = 0V$ to 3V step, $V_{IN} = V_{CC} / 2$ , $A_V = +1$		5		$\mu s$
Input Noise-Voltage Density	$f = 1kHz$		25		nV/ $\sqrt{Hz}$
Input Noise-Current Density	$f = 1kHz$		0.1		pA/ $\sqrt{Hz}$
Amp-Amp Isolation	$f = 1kHz$		125		dB

## DC ELECTRICAL CHARACTERISTICS

( $V_{CC} = 2.7V$  to  $6V$ ,  $V_{EE} = GND$ ,  $V_{CM} = 0V$ ,  $V_{OUT} = V_{CC} / 2$ ,  $T_A = 0^{\circ}C$  to  $+70^{\circ}C$ , unless otherwise noted.)

PARAMETER	CONDITIONS	MIN	TYP	MAX	UNITS
Input Offset Voltage	$V_{CM} = V_{EE}$ to $V_{CC}$			$\pm 650$	$\mu V$
Input Offset Voltage Tempco			$\pm 2$		$\mu V/^{\circ}C$
Input Bias Current	$V_{CM} = V_{EE}$ to $V_{CC}$			$\pm 75$	nA
Input Offset Current	$V_{CM} = V_{EE}$ to $V_{CC}$			$\pm 6$	nA
Common-Mode Input Voltage Range		$V_{EE} - 0.20$		$V_{CC} + 0.20$	V
Common-Mode Rejection Ratio	$(V_{EE} - 0.20) \leq V_{CM} \leq (V_{CC} + 0.20)$	72			dB
Power-Supply Rejection Ratio	$V_{CC} = 2.7V$ to $6V$	86			dB
Large-Signal Voltage Gain (Note 1)	$V_{CC} = 2.7V$ , $R_L = 100k\Omega$ , $V_{OUT} = 0.25V$ to $2.45V$	Sourcing	88		dB
		Sinking	84		
	$V_{CC} = 2.7V$ , $R_L = 1k\Omega$ , $V_{OUT} = 0.5V$ to $2.2V$	Sourcing	92		
		Sinking	76		
	$V_{CC} = 5.0V$ , $R_L = 100k\Omega$ , $V_{OUT} = 0.25V$ to $4.75V$	Sourcing	92		
		Sinking	88		
	$V_{CC} = 5.0V$ , $R_L = 1k\Omega$ , $V_{OUT} = 0.5V$ to $4.5V$	Sourcing	96		
		Sinking	82		
Output Voltage Swing (Note 1)	$R_L = 100k\Omega$	$V_{OH}$	$V_{CC} - 0.075$		V
		$V_{OL}$	$V_{EE} + 0.075$		
	$R_L = 1k\Omega$	$V_{OH}$	$V_{CC} - 0.20$		
		$V_{OL}$	$V_{EE} + 0.20$		
Operating Supply Voltage Range		2.7		6.0	V
Supply Current (per amplifier)	$V_{CM} = V_{OUT} = V_{CC} / 2$	$V_{CC} = 2.7V$		175	$\mu A$
		$V_{CC} = 5V$		190	

# Single/Dual/Quad, Micropower, Single-Supply Rail-to-Rail Op Amps

## DC ELECTRICAL CHARACTERISTICS

( $V_{CC} = 2.7V$  to  $6V$ ,  $V_{EE} = GND$ ,  $V_{CM} = 0V$ ,  $V_{OUT} = V_{CC} / 2$ ,  $T_A = -40^{\circ}C$  to  $+85^{\circ}C$ , unless otherwise noted.)

PARAMETER	CONDITIONS		MIN	TYP	MAX	UNITS
Input Offset Voltage	$V_{CM} = V_{EE}$ to $V_{CC}$				±950	μV
Input Offset Voltage Tempco				±2		μV/°C
Input Bias Current	$V_{CM} = V_{EE}$ to $V_{CC}$				±100	nA
Input Offset Current	$V_{CM} = V_{EE}$ to $V_{CC}$				±8	nA
Common-Mode Input Voltage Range			$V_{EE} - 0.15$	$V_{CC} + 0.15$		V
Common-Mode Rejection Ratio	$(V_{EE} - 0.15) \leq V_{CM} \leq (V_{CC} + 0.15)$		68			dB
Power-Supply Rejection Ratio	$V_{CC} = 2.7V$ to $6V$ , $V_{CM} = 0V$		84			dB
Large-Signal Voltage Gain (Note 1)	$V_{CC} = 2.7V$ , $R_L = 100k\Omega$ , $V_{OUT} = 0.25V$ to $2.45V$	Sourcing	86			dB
		Sinking	84			
	$V_{CC} = 2.7V$ , $R_L = 1k\Omega$ , $V_{OUT} = 0.5V$ to $2.2V$	Sourcing	92			
		Sinking	76			
	$V_{CC} = 5.0V$ , $R_L = 100k\Omega$ , $V_{OUT} = 0.25V$ to $4.75V$	Sourcing	92			
		Sinking	86			
	$V_{CC} = 5.0V$ , $R_L = 1k\Omega$ , $V_{OUT} = 0.5V$ to $4.5V$	Sourcing	96			
		Sinking	80			
Output Voltage Swing (Note 1)	$R_L = 100k\Omega$	$V_{OH}$	$V_{CC} - 0.075$			V
		$V_{OL}$	$V_{EE} + 0.075$			
	$R_L = 1k\Omega$	$V_{OH}$	$V_{CC} - 0.20$			
		$V_{OL}$	$V_{EE} + 0.20$			
Operating Supply-Voltage Range			2.7		6.0	V
Supply Current (per amplifier)	$V_{CM} = V_{OUT} = V_{CC} / 2$	$V_{CC} = 2.7V$			185	μA
		$V_{CC} = 5V$			200	

# Single/Dual/Quad, Micropower, Single-Supply Rail-to-Rail Op Amps

MAX492/MAX494/MAX495

## DC ELECTRICAL CHARACTERISTICS

( $V_{CC} = 2.7V$  to  $6V$ ,  $V_{EE} = GND$ ,  $V_{CM} = 0V$ ,  $V_{OUT} = V_{CC} / 2$ ,  $T_A = -55^{\circ}C$  to  $+125^{\circ}C$ , unless otherwise noted.)

PARAMETER	CONDITIONS		MIN	TYP	MAX	UNITS
Input Offset Voltage	$V_{CM} = V_{EE}$ to $V_{CC}$				$\pm 1.2$	mV
Input Offset Voltage Tempco				$\pm 2$		$\mu V/^{\circ}C$
Input Bias Current	$V_{CM} = V_{EE}$ to $V_{CC}$				$\pm 200$	nA
Input Offset Current	$V_{CM} = V_{EE}$ to $V_{CC}$				$\pm 10$	nA
Common-Mode Input Voltage Range			$V_{EE} - 0.05$		$V_{CC} + 0.05$	V
Common-Mode Rejection Ratio	$(V_{EE} - 0.05V) \leq V_{CM} \leq (V_{CC} + 0.05V)$		66			dB
Power-Supply Rejection Ratio	$V_{CC} = 2.7V$ to $6V$		80			dB
Large-Signal Voltage Gain (Note 1)	$V_{CC} = 2.7V$ , $R_L = 100k\Omega$ , $V_{OUT} = 0.25V$ to $2.45V$	Sourcing	82			dB
		Sinking	80			
	$V_{CC} = 2.7V$ , $R_L = 1k\Omega$ , $V_{OUT} = 0.5V$ to $2.2V$	Sourcing	90			
		Sinking	72			
	$V_{CC} = 5.0V$ , $R_L = 100k\Omega$ , $V_{OUT} = 0.25V$ to $4.75V$	Sourcing	86			
		Sinking	82			
	$V_{CC} = 5.0V$ , $R_L = 1k\Omega$ , $V_{OUT} = 0.5V$ to $4.5V$	Sourcing	94			
		Sinking	76			
Output Voltage Swing (Note 1)	$R_L = 100k\Omega$	$V_{OH}$	$V_{CC} - 0.075$			V
		$V_{OL}$		$V_{EE} + 0.075$		
	$R_L = 1k\Omega$	$V_{OH}$	$V_{CC} - 0.250$			
		$V_{OL}$		$V_{EE} + 0.250$		
Operating Supply-Voltage Range			2.7		6.0	V
Supply Current (per amplifier)	$V_{CM} = V_{OUT} = V_{CC} / 2$	$V_{CC} = 2.7V$			200	$\mu A$
		$V_{CC} = 5V$			225	

**Note 1:**  $R_L$  to  $V_{EE}$  for sourcing and  $V_{OH}$  tests;  $R_L$  to  $V_{CC}$  for sinking and  $V_{OL}$  tests.

# Single/Dual/Quad, Micropower, Single-Supply Rail-to-Rail Op Amps

## Typical Operating Characteristics

( $T_A = +25^\circ\text{C}$ ,  $V_{CC} = 5\text{V}$ ,  $V_{EE} = 0\text{V}$ , unless otherwise noted.)

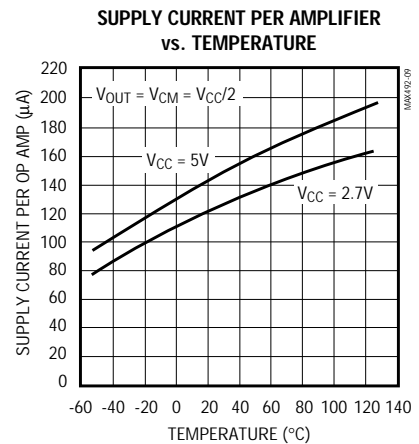
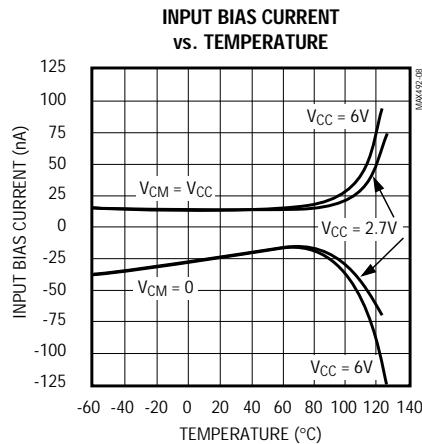
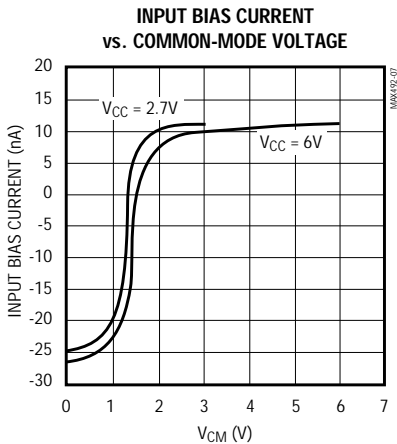
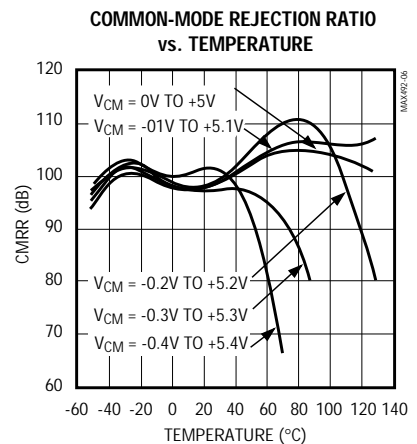
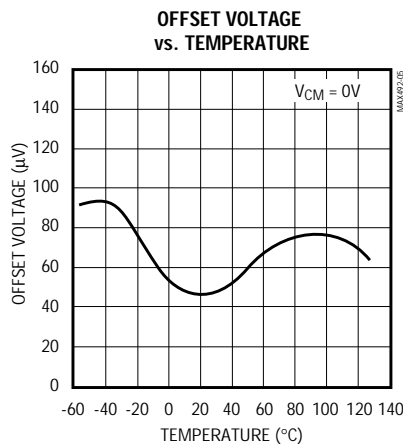
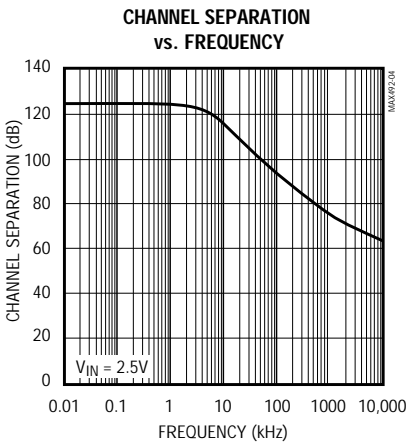
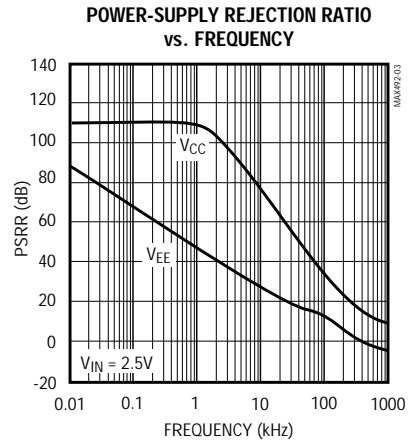
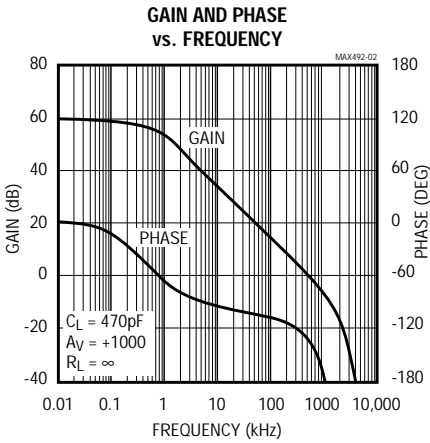
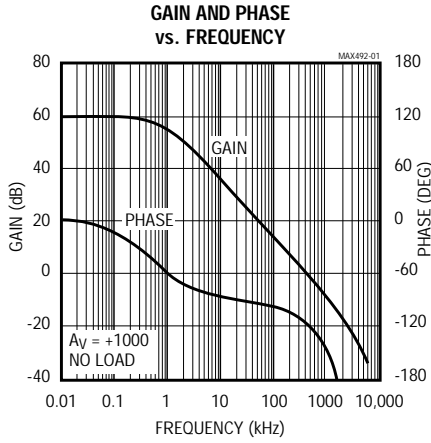

# Single/Dual/Quad, Micropower, Single-Supply Rail-to-Rail Op Amps

## Typical Operating Characteristics (continued)

( $T_A = +25^\circ\text{C}$ ,  $V_{CC} = 5\text{V}$ ,  $V_{EE} = 0\text{V}$ , unless otherwise noted.)

MAX492/MAX494/MAX495

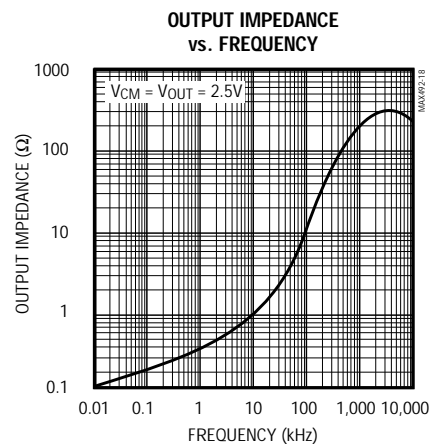
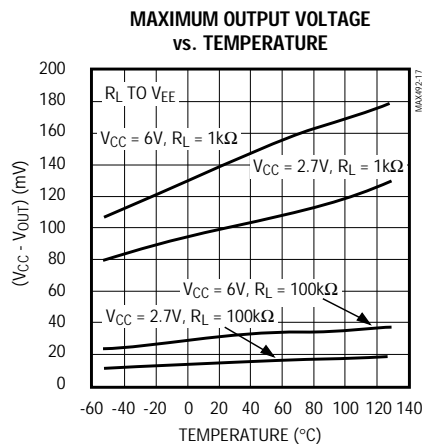
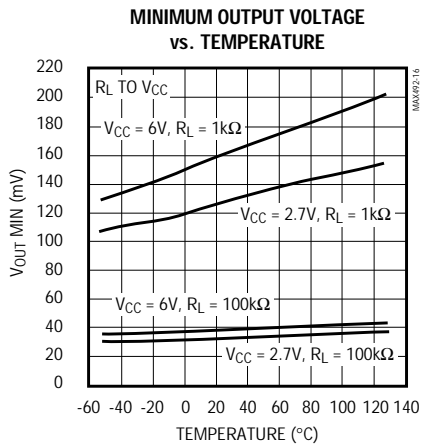
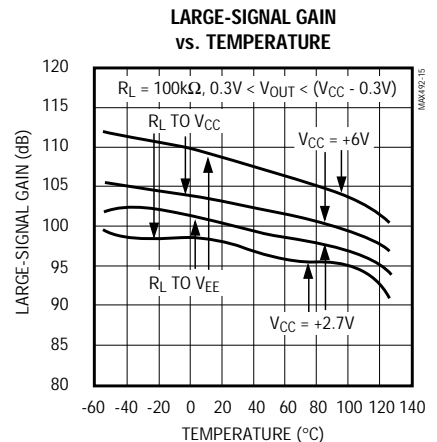
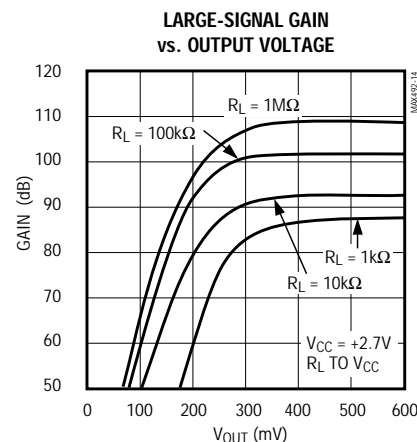
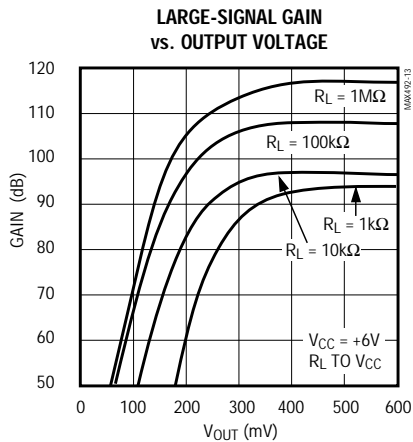
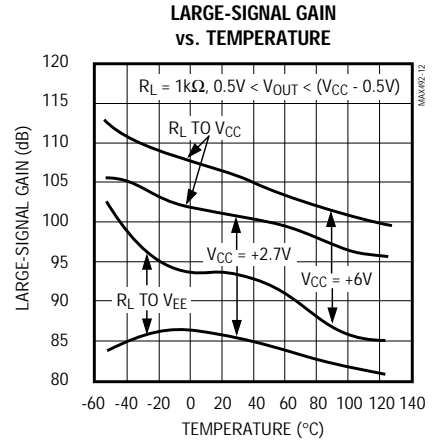
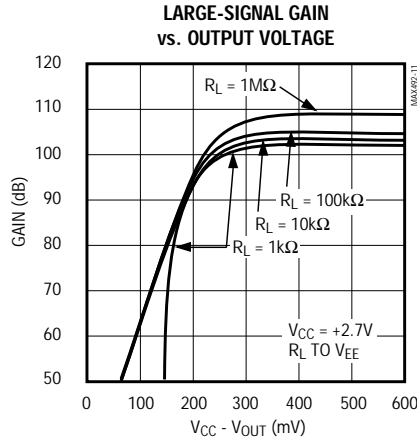
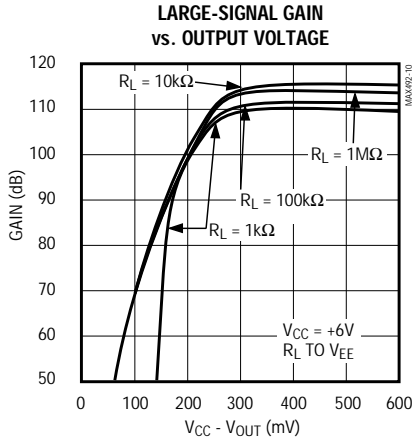

# Single/Dual/Quad, Micropower, Single-Supply Rail-to-Rail Op Amps

## Typical Operating Characteristics (continued)

( $T_A = +25^\circ\text{C}$ ,  $V_{CC} = 5\text{V}$ ,  $V_{EE} = 0\text{V}$ , unless otherwise noted.)

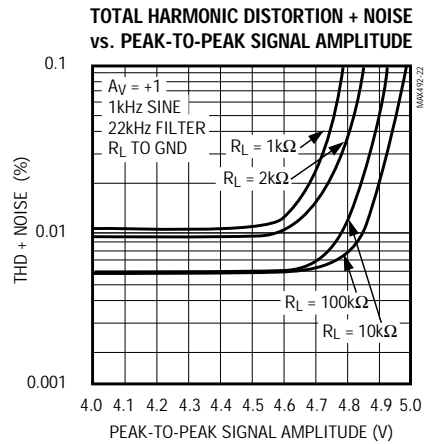
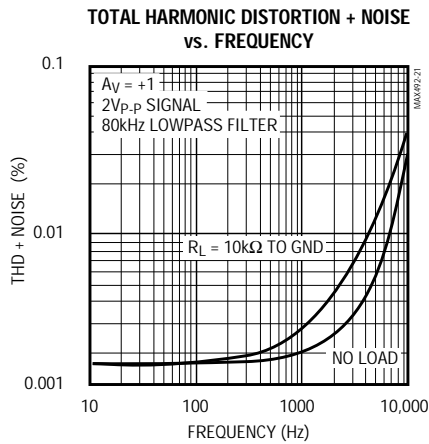
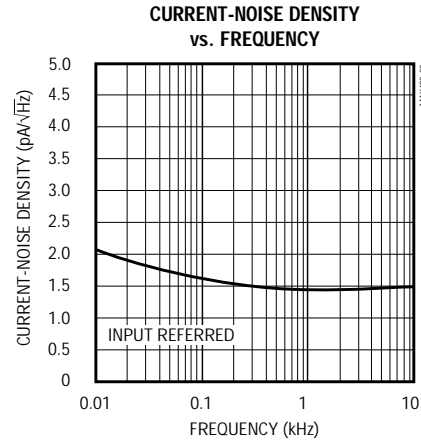
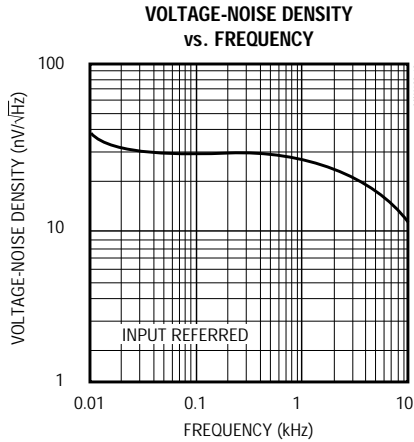

**SMALL-SIGNAL TRANSIENT RESPONSE**

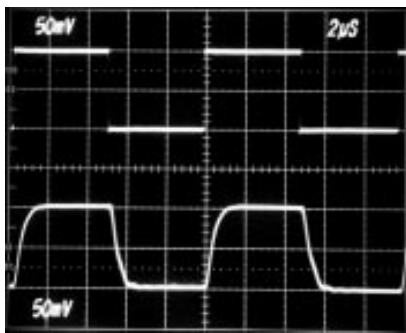

$V_{CC} = +5\text{V}$ ,  $A_V = +1$ ,  $R_L = 10\text{k}\Omega$

**SMALL-SIGNAL TRANSIENT RESPONSE**

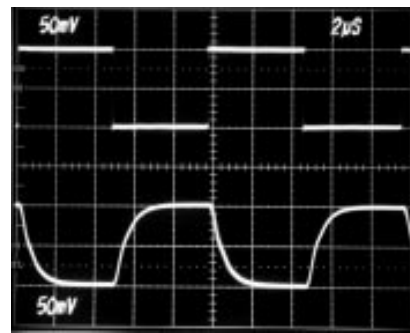

$V_{CC} = +5\text{V}$ ,  $A_V = -1$ ,  $R_L = 10\text{k}\Omega$



# Single/Dual/Quad, Micropower, Single-Supply Rail-to-Rail Op Amps

## Typical Operating Characteristics (continued)

( $T_A = +25^\circ\text{C}$ ,  $V_{CC} = 5\text{V}$ ,  $V_{EE} = 0\text{V}$ , unless otherwise noted.)

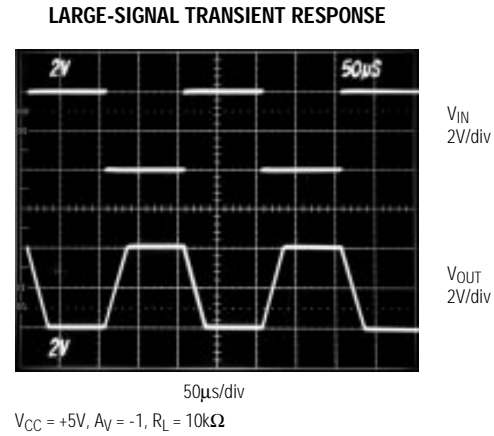
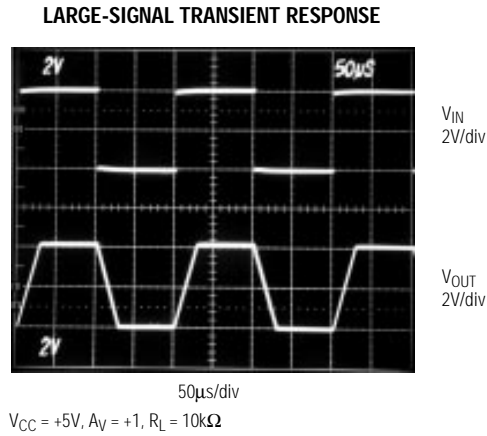

## Pin Description

PIN			NAME	FUNCTION
MAX492	MAX494	MAX495		
1	1	—	OUT1	Amplifier 1 Output
—	—	1, 5	NULL	Offset Null Input. Connect to a 10kΩ potentiometer for offset-voltage trimming. Connect wiper to $V_{EE}$ (Figure 3).
—	—	2	IN-	Inverting Input
2	2	—	IN1-	Amplifier 1 Inverting Input
—	—	3	IN+	Noninverting Input
3	3	—	IN1+	Amplifier 1 Noninverting Input
4	11	4	$V_{EE}$	Negative Power-Supply Pin. Connect to ground or a negative voltage.
5	5	—	IN2+	Amplifier 2 Noninverting Input
—	—	6	OUT	Amplifier Output
6	6	—	IN2-	Amplifier 2 Inverting Input
7	7	—	OUT2	Amplifier 2 Output
8	4	7	$V_{CC}$	Positive Power-Supply Pin. Connect to (+) terminal of power supply.
—	8	—	OUT3	Amplifier 3 Output
—	9	—	IN3-	Amplifier 3 Inverting Input
—	10	—	IN3+	Amplifier 3 Noninverting Input
—	12	—	IN4+	Amplifier 4 Noninverting Input
—	13	—	IN4-	Amplifier 4 Inverting Input
—	14	—	OUT4	Amplifier 4 Output
—	—	8	N.C.	No Connect. Not internally connected.

# Single/Dual/Quad, Micropower, Single-Supply Rail-to-Rail Op Amps

## Applications Information

The dual MAX492, quad MAX494, and single MAX495 op amps combine excellent DC accuracy with rail-to-rail operation at both input and output. With their precision performance, wide dynamic range at low supply voltages, and very low supply current, these op amps are ideal for battery-operated equipment and other low-voltage applications.

### Rail-to-Rail Inputs and Outputs

The MAX492/MAX494/MAX495's input common-mode range extends 0.25V **beyond** the positive and negative supply rails, with excellent common-mode rejection. Beyond the specified common-mode range, the outputs are guaranteed not to undergo phase reversal or latchup. Therefore, the MAX492/MAX494/MAX495 can be used in applications with common-mode signals at or even beyond the supplies, without the problems associated with typical op amps.

The MAX492/MAX494/MAX495's output voltage swings to within 50mV of the supplies with a 100k $\Omega$  load. This rail-to-rail swing at the input and output substantially increases the dynamic range, especially in low supply-voltage applications. Figure 1 shows the input and output waveforms for the MAX492, configured as a unity-gain noninverting buffer operating from a single +3V supply. The input signal is 3.0V<sub>p-p</sub>, 1kHz sinusoid centered at +1.5V. The output amplitude is approximately 2.95V<sub>p-p</sub>.

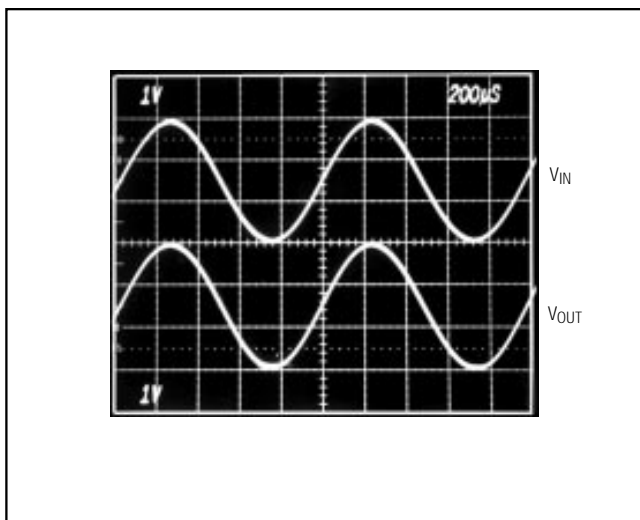

Figure 1. Rail-to-Rail Input and Output (Voltage Follower Circuit,  $V_{CC} = +3V$ ,  $V_{EE} = 0V$ )

### Input Offset Voltage

Rail-to-rail common-mode swing at the input is obtained by two complementary input stages in parallel, which feed a folded cascaded stage. The PNP stage is active for input voltages close to the negative rail, and the NPN stage is active for input voltages close to the positive rail.

The offsets of the two pairs are trimmed; however, there is some small residual mismatch between them. This mismatch results in a two-level input offset characteristic, with a transition region between the levels occurring at a common-mode voltage of approximately 1.3V. Unlike other rail-to-rail op amps, the transition region has been widened to approximately 600mV in order to minimize the slight degradation in CMRR caused by this mismatch.

To adjust the MAX495's input offset voltage (500 $\mu$ V max at +25°C), connect a 10k $\Omega$  trim potentiometer between the two NULL pins (pins 1 and 5), with the wiper connected to VEE (pin 4) (Figure 2). The trim range of this circuit is  $\pm 6$ mV. External offset adjustment is not available for the dual MAX492 or quad MAX494.

The input bias currents of the MAX492/MAX494/MAX495 are typically less than 50nA. The bias current flows into the device when the NPN input stage is active, and it flows out when the PNP input stage is active. To reduce the offset error caused by input bias current flowing through external source resistances, match the effective resistance seen at each input. Connect resistor R3 between the noninverting input and ground when using

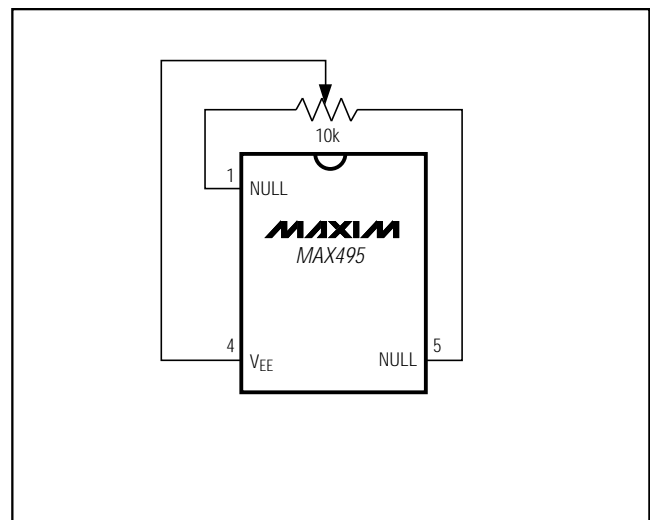

Figure 2. Offset Null Circuit

# Single/Dual/Quad, Micropower, Single-Supply Rail-to-Rail Op Amps

MAX492/MAX494/MAX495

the op amp in an inverting configuration (Figure 3a); connect resistor R3 between the noninverting input and the input signal when using the op amp in a noninverting configuration (Figure 3b). Select R3 to equal the parallel combination of R1 and R2. High source resistances will degrade noise performance, due to the thermal noise of the resistor and the input current noise (which is multiplied by the source resistance).

### Input Stage Protection Circuitry

The MAX492/MAX494/MAX495 include internal protection circuitry that prevents damage to the precision input stage from large differential input voltages. This protection circuitry consists of back-to-back diodes between IN+ and IN- with two 1.7kΩ resistors in series

(Figure 4). The diodes limit the differential voltage applied to the amplifiers' internal circuitry to no more than V<sub>F</sub>, where V<sub>F</sub> is the diodes' forward-voltage drop (about 0.7V at +25°C).

Input bias current for the ICs (±25nA typical) is specified for the small differential input voltages. For large differential input voltages (exceeding V<sub>F</sub>), this protection circuitry increases the input current at IN+ and IN-:

$$\text{Input Current} = \frac{(V_{IN+} - V_{IN-}) - V_F}{2 \times 1.7k\Omega}$$

For comparator applications requiring large differential voltages (greater than V<sub>F</sub>), you can limit the input current that flows through the diodes with external resistors

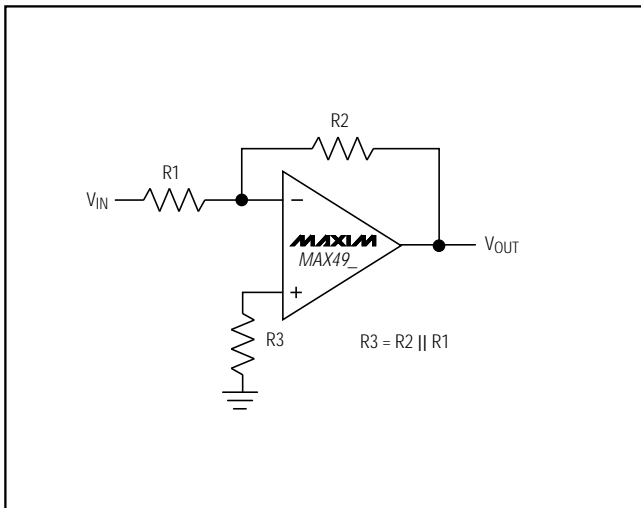

Figure 3a. Reducing Offset Error Due to Bias Current: Inverting Configuration

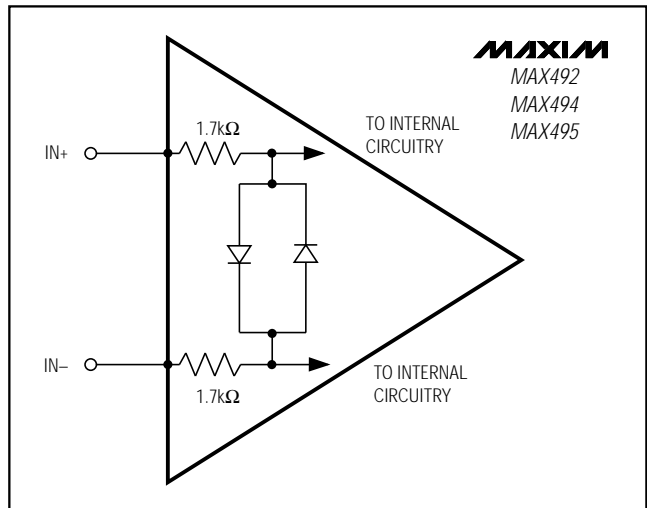

Figure 4. Input Stage Protection Circuitry

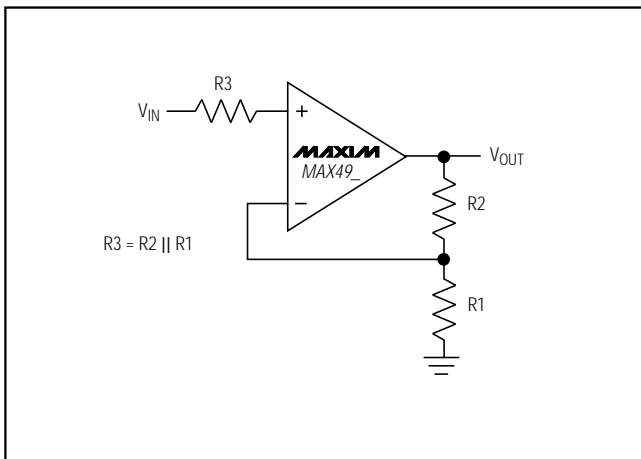

Figure 3b. Reducing Offset Error Due to Bias Current: Noninverting Configuration

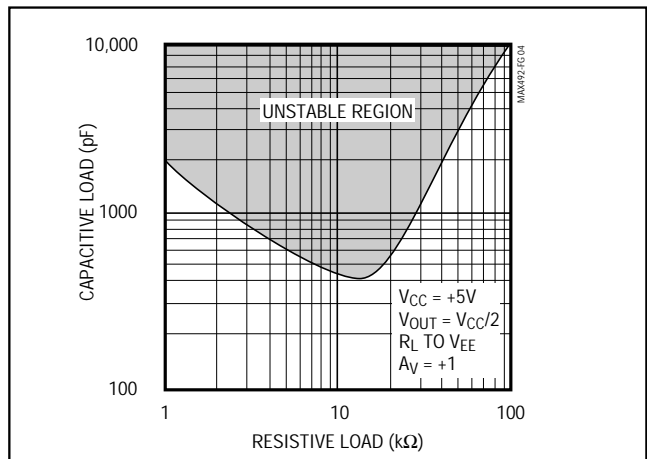

Figure 5. Capacitive-Load Stable Region Sourcing Current

# Single/Dual/Quad, Micropower, Single-Supply Rail-to-Rail Op Amps

in series with IN-, IN+, or both. Series resistors are not recommended for amplifier applications, as they may increase input offsets and decrease amplifier bandwidth.

## Output Loading and Stability

Even with their low quiescent current of less than 150 $\mu$ A per op amp, the MAX492/MAX494/MAX495 are well suited for driving loads up to 1k $\Omega$  while maintaining DC accuracy. Stability while driving heavy capacitive loads is another key advantage over comparable CMOS rail-to-rail op amps.

In op amp circuits, driving large capacitive loads increases the likelihood of oscillation. This is especially true for circuits with high loop gains, such as a unity-gain voltage follower. The output impedance and a capacitive load form an RC network that adds a pole to the loop response and induces phase lag. If the pole frequency is low enough—as when driving a large capacitive load—the circuit phase margin is degraded, leading to either an under-damped pulse response or oscillation.

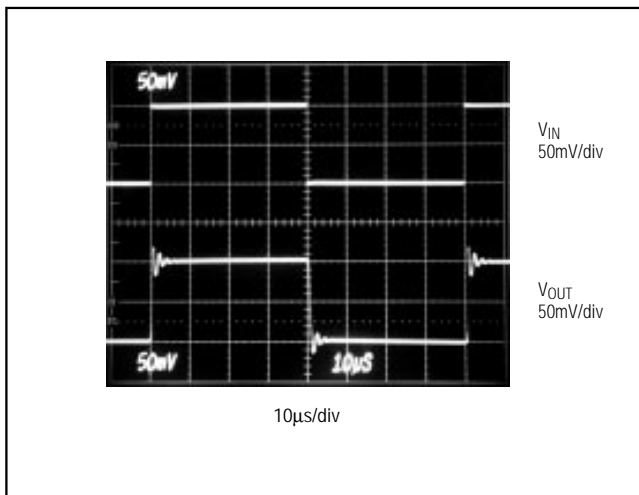

Figure 6. MAX492 Voltage Follower with 1000pF Load— $R_L = \infty$

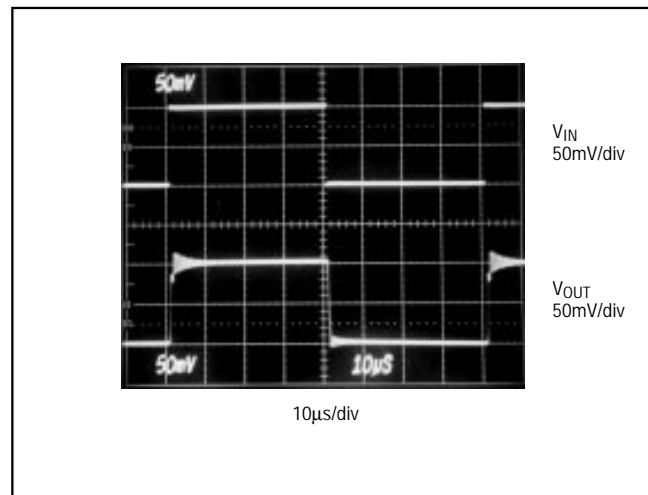

Figure 7b. MAX492 Voltage Follower with 500pF Load— $R_L = 20k\Omega$

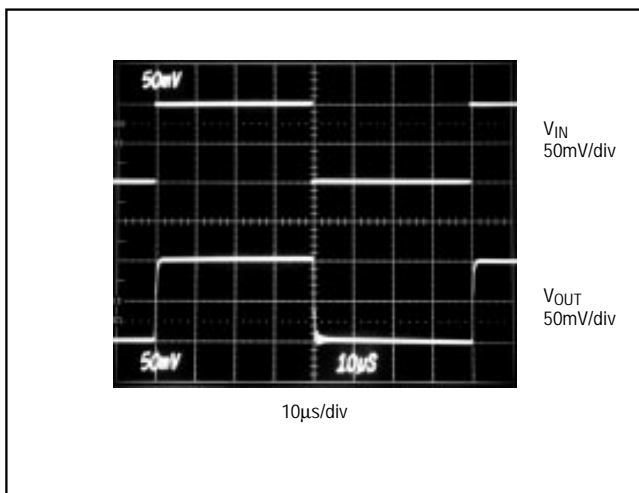

Figure 7a. MAX492 Voltage Follower with 500pF Load— $R_L = 5k\Omega$

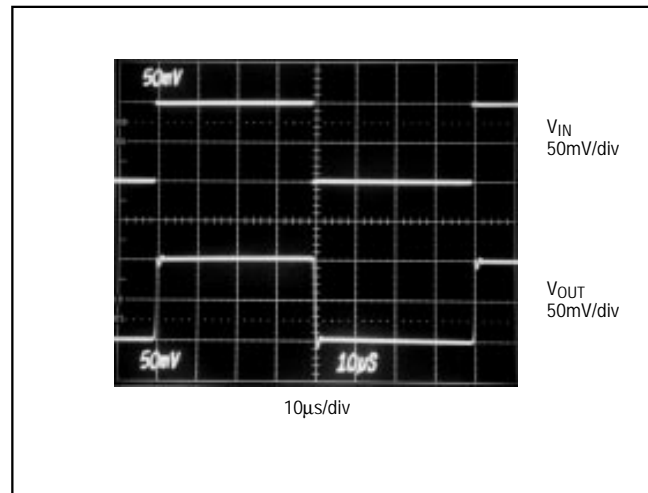

Figure 7c. MAX492 Voltage Follower with 500pF Load— $R_L = \infty$

# Single/Dual/Quad, Micropower, Single-Supply Rail-to-Rail Op Amps

MAX492/MAX494/MAX495

The MAX492/MAX494/MAX495 can drive capacitive loads in excess of 1000pF under certain conditions (Figure 5). When driving capacitive loads, the greatest potential for instability occurs when the op amp is sourcing approximately 100 $\mu$ A. Even in this case, stability is maintained with up to 400pF of output capacitance. If the output sources either more or less current, stability is increased. These devices perform well with a 1000pF pure capacitive load (Figure 6). Figure 7 shows the performance with a 500pF load in parallel with various load resistors.

To increase stability while driving large capacitive loads, connect a pull-up resistor at the output to decrease the current that the amplifier must source. If the amplifier is made to sink current rather than source, stability is further increased.

Frequency stability can be improved by adding an output isolation resistor ( $R_S$ ) to the voltage-follower circuit (Figure 8). This resistor improves the phase margin of the circuit by isolating the load capacitor from the op amp's output. Figure 9a shows the MAX492 driving 10,000pF ( $R_L \geq 100k\Omega$ ), while Figure 9b adds a 47 $\Omega$  isolation resistor.

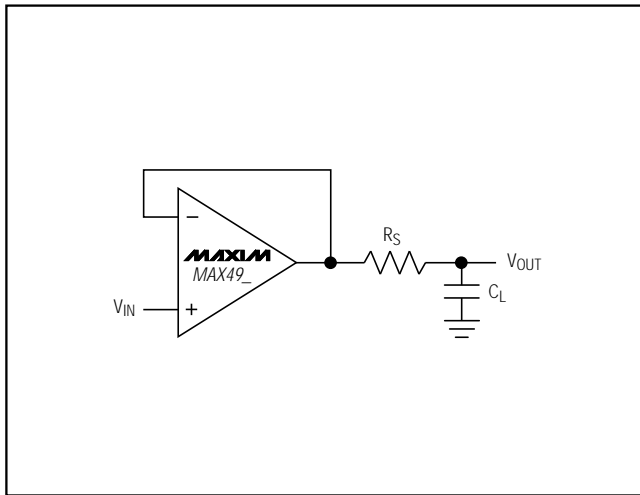

Figure 8. Capacitive-Load Driving Circuit

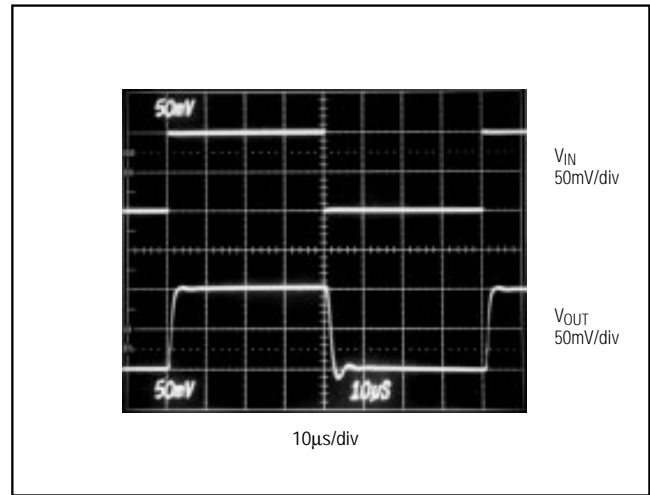

Figure 9b. Driving a 10,000pF Capacitive Load with a 47 $\Omega$  Isolation Resistor

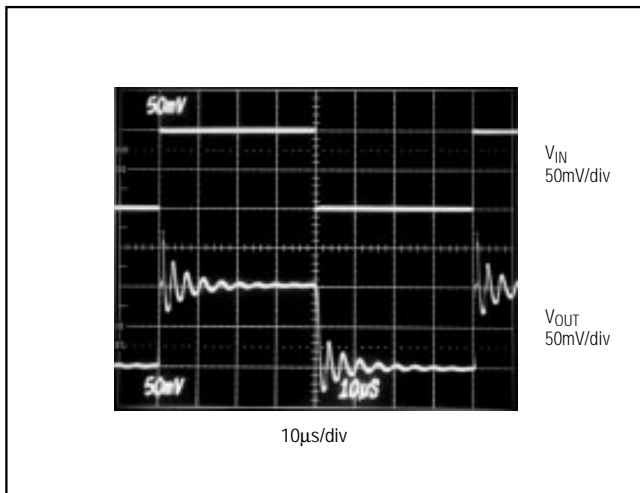

Figure 9a. Driving a 10,000pF Capacitive Load

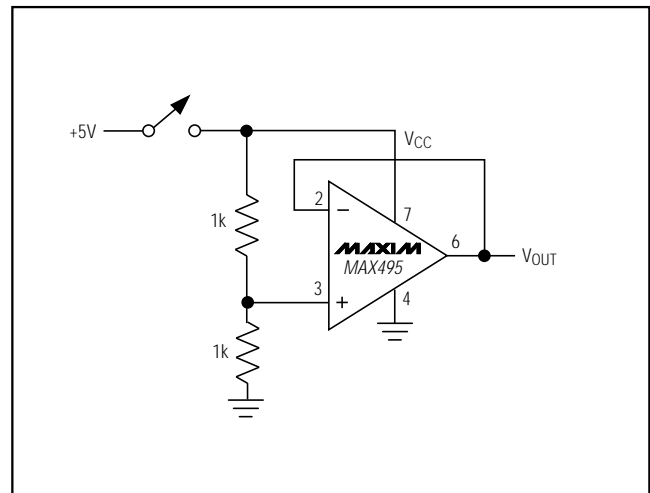

Figure 10. Power-Up Test Configuration

# Single/Dual/Quad, Micropower, Single-Supply Rail-to-Rail Op Amps

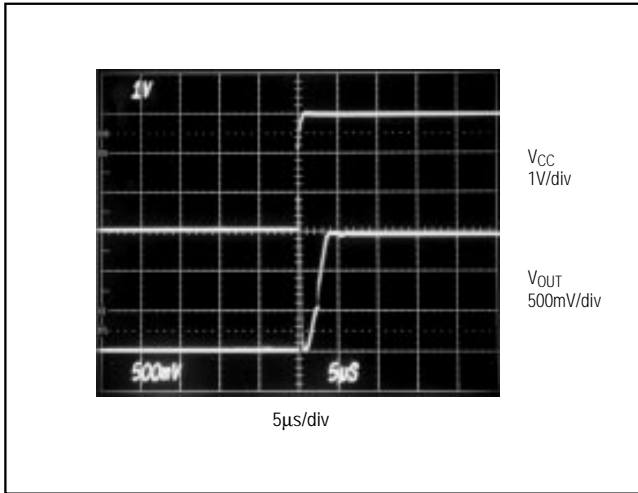

Figure 11a. Power-Up Settling Time ( $V_{CC} = +3V$ )

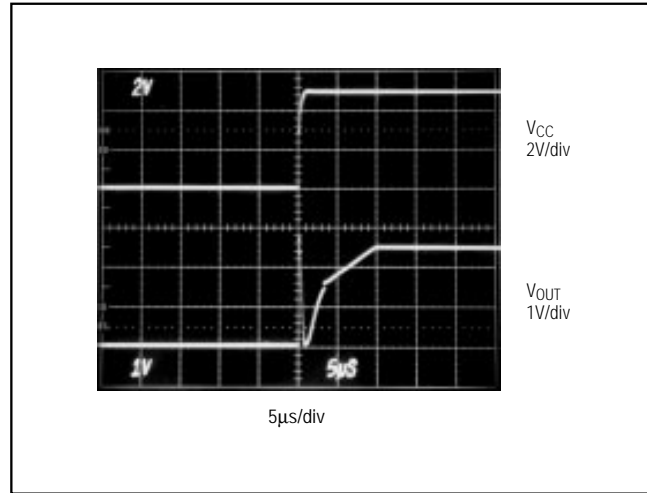

Figure 11b. Power-Up Settling Time ( $V_{CC} = +5V$ )

Because the MAX492/MAX494/MAX495 have excellent stability, no isolation resistor is required, except in the most demanding applications. This is beneficial because an isolation resistor would degrade the low-frequency performance of the circuit.

### Power-Up Settling Time

The MAX492/MAX494/MAX495 have a typical supply current of  $150\mu A$  per op amp. Although supply current is already low, it is sometimes desirable to reduce it further by powering down the op amp and associated ICs for periods of time. For example, when using a MAX494 to buffer the inputs to a multi-channel analog-to-digital converter (ADC), much of the circuitry could be powered down between data samples to increase battery life. If samples are taken infrequently, the op amps, along with the ADC, may be powered down most of the time.

When power is reapplied to the MAX492/MAX494/MAX495, it takes some time for the voltages on the supply pin and the output pin of the op amp to settle. Supply settling time depends on the supply voltage, the value of the bypass capacitor, the output impedance of the incoming supply, and any lead resistance or inductance between components. Op amp settling time depends primarily on the output voltage and is slew-rate limited. With the noninverting input to a voltage follower held at mid-supply (Figure 10), when the supply steps from 0V to  $V_{CC}$ , the output settles in approximately  $4\mu s$  for  $V_{CC} = +3V$  (Figure 11a) or  $10\mu s$  for  $V_{CC} = +5V$  (Figure 11b).

### Power Supplies and Layout

The MAX492/MAX494/MAX495 operate from a single 2.7V to 6V power supply, or from dual supplies of  $\pm 1.35V$  to  $\pm 3V$ . For single-supply operation, bypass the power supply with a  $1\mu F$  capacitor in parallel with a  $0.1\mu F$  ceramic capacitor. If operating from dual supplies, bypass each supply to ground.

Good layout improves performance by decreasing the amount of stray capacitance at the op amp's inputs and output. To decrease stray capacitance, minimize both trace lengths and resistor leads and place external components close to the op amp's pins.

### Rail-to-Rail Buffers

The *Typical Operating Circuit* shows a MAX495 gain-of-two buffer driving the analog input to a MAX187 12-bit ADC. Both devices run from a single 5V supply, and the converter's internal reference is 4.096V. The MAX495's typical input offset voltage is  $200\mu V$ . This results in an error at the ADC input of  $400\mu V$ , or less than half of one least significant bit (LSB). Without offset trimming, the op amp contributes negligible error to the conversion result.

# Single/Dual/Quad, Micropower, Single-Supply Rail-to-Rail Op Amps

MAX492/MAX494/MAX495

## Ordering Information (continued)

PART	TEMP. RANGE	PIN-PACKAGE
MAX494CPD	0°C to +70°C	14 Plastic DIP
MAX494CSD	0°C to +70°C	14 SO
MAX494EPD	-40°C to +85°C	14 Plastic DIP
MAX494ESD	-40°C to +85°C	14 SO
MAX494MJD	-55°C to +125°C	14 CERDIP
MAX495CPA	0°C to +70°C	8 Plastic DIP
MAX495CSA	0°C to +70°C	8 SO
MAX495CUA	0°C to +70°C	8 $\mu$ MAX
MAX495C/D	0°C to +70°C	Dice*
MAX495EPA	-40°C to +85°C	8 Plastic DIP
MAX495ESA	-40°C to +85°C	8 SO
MAX495MJA	-55°C to +125°C	8 CERDIP

\* Dice are specified at  $T_A = +25^\circ\text{C}$ , DC parameters only.

## Chip Topographies

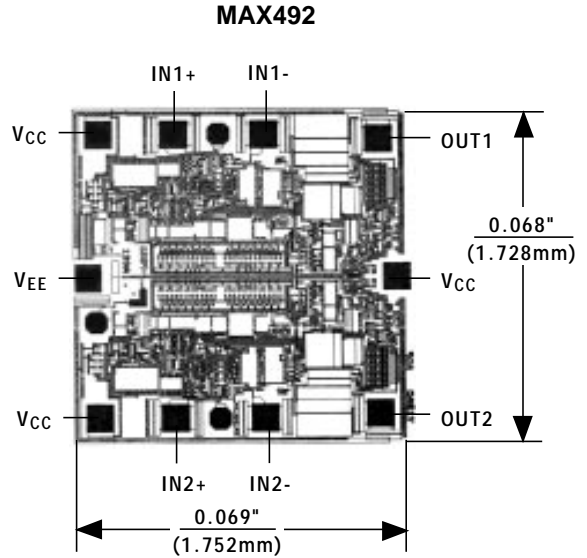

## Pin Configurations (continued)

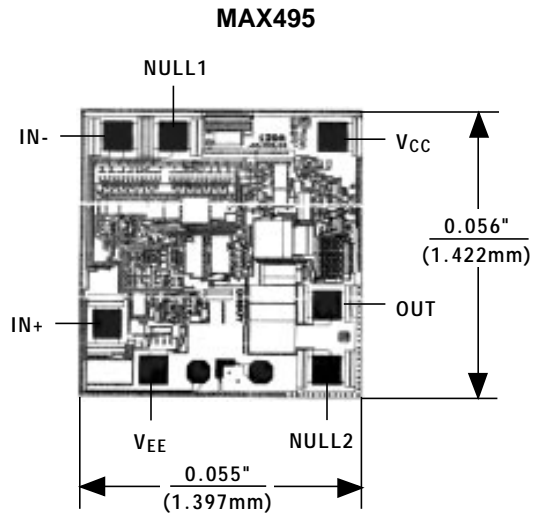
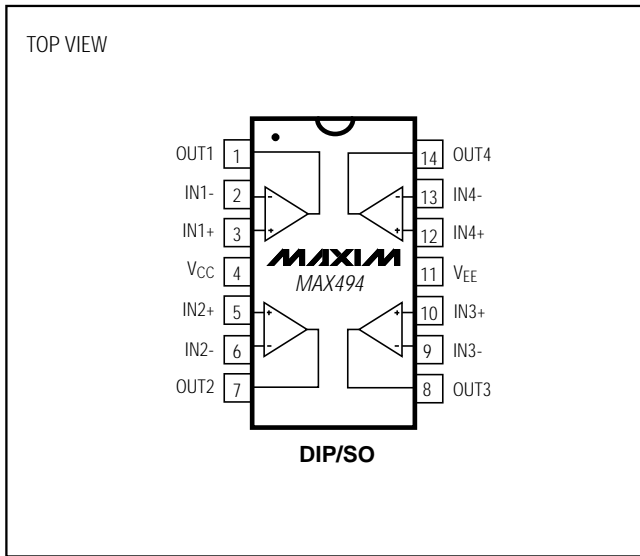

TRANSISTOR COUNT: 134 (single MAX495)  
 268 (dual MAX492)  
 536 (quad MAX494)  
 SUBSTRATE CONNECTED TO VEE

# Single/Dual/Quad, Micropower, Single-Supply Rail-to-Rail Op Amps

## Package Information

DIM	INCHES		MILLIMETERS	
	MIN	MAX	MIN	MAX
A	0.036	0.044	0.91	1.11
A1	0.004	0.008	0.10	0.20
B	0.010	0.014	0.25	0.36
C	0.005	0.007	0.13	0.18
D	0.116	0.120	2.95	3.05
E	0.116	0.120	2.95	3.05
e	0.0256		0.65	
H	0.188	0.198	4.78	5.03
L	0.016	0.026	0.41	0.66
α	0°	6°	0°	6°

21-0036D

**8-PIN μMAX  
MICROMAX SMALL-OUTLINE  
PACKAGE**

DIM	INCHES		MILLIMETERS	
	MIN	MAX	MIN	MAX
A	0.053	0.069	1.35	1.75
A1	0.004	0.010	0.10	0.25
B	0.014	0.019	0.35	0.49
C	0.007	0.010	0.19	0.25
E	0.150	0.157	3.80	4.00
e	0.050		1.27	
H	0.228	0.244	5.80	6.20
L	0.016	0.050	0.40	1.27

DIM	PINS	INCHES		MILLIMETERS	
		MIN	MAX	MIN	MAX
D	8	0.189	0.197	4.80	5.00
D	14	0.337	0.344	8.55	8.75
D	16	0.386	0.394	9.80	10.00

21-0041A

**Narrow SO  
SMALL-OUTLINE  
PACKAGE  
(0.150 in.)**

Maxim cannot assume responsibility for use of any circuitry other than circuitry entirely embodied in a Maxim product. No circuit patent licenses are implied. Maxim reserves the right to change the circuitry and specifications without notice at any time.

16 \_\_\_\_\_ Maxim Integrated Products, 120 San Gabriel Drive, Sunnyvale, CA 94086 (408) 737-7600



# Mouser Electronics

Authorized Distributor

Click to View Pricing, Inventory, Delivery & Lifecycle Information:

## Maxim Integrated:

[MAX492CPA+](#) [MAX492CSA+](#) [MAX492ESA+](#) [MAX494CPD+](#) [MAX494CSD+](#) [MAX494ESD+](#) [MAX492CPA](#)  
[MAX492CSA](#) [MAX492CSA+T](#) [MAX492EPA](#) [MAX492EPA+](#) [MAX492ESA](#) [MAX492ESA+T](#) [MAX494CPD](#)  
[MAX494CSD](#) [MAX494CSD+T](#) [MAX494EPD+](#) [MAX494ESD](#) [MAX494ESD+T](#) [MAX492CSA-T](#) [MAX492ESA-T](#)  
[MAX494CSD-T](#) [MAX494ESD-T](#)