

# MAX6325/MAX6341/MAX6350

## 1ppm/°C, Low-Noise, +2.5V/+4.096V/+5V Voltage References

### ABSOLUTE MAXIMUM RATINGS

(Voltages Referenced to GND)

IN	-0.3V to 40V
OUT, TRIM	-0.3V to 12V
NR	-0.3V to 6V
OUT Short-Circuit to GND Duration ( $V_{IN} \leq 12V$ )	Continuous
OUT Short-Circuit to GND Duration ( $V_{IN} \leq 40V$ )	5s
OUT Short-Circuit to IN Duration ( $V_{IN} \leq 12V$ )	Continuous
Continuous Power Dissipation ( $T_A = +70^\circ C$ )	
8-Pin Plastic DIP (derate 9.09mW/°C above +70°C)	727mW

8-Pin SO (derate 5.88mW/°C above +70°C)	471mW
8-Pin CERDIP (derate 8.00mW/°C above +70°C)	640mW
Operating Temperature Ranges	
MAX63_C_A	0°C to +70°C
MAX63_E_A	-40°C to +85°C
MAX63_MJA	-55°C to +125°C
Storage Temperature Range	-65°C to +150°C
Lead Temperature (soldering, 10s)	+300°C

Stresses beyond those listed under "Absolute Maximum Ratings" may cause permanent damage to the device. These are stress ratings only, and functional operation of the device at these or any other conditions beyond those indicated in the operational sections of the specifications is not implied. Exposure to absolute maximum rating conditions for extended periods may affect device reliability.

### ELECTRICAL CHARACTERISTICS—MAX6325

( $V_{IN} = +10V$ ,  $I_{OUT} = 0mA$ ,  $T_A = T_{MIN}$  to  $T_{MAX}$ , unless otherwise noted. Typical values are at  $T_A = +25^\circ C$ .)

PARAMETER	SYMBOL	CONDITIONS	$T_A$	MIN	TYP	MAX	UNITS
Input Voltage Range	$V_{IN}$		C, E, M	8		36	V
Output Voltage	$V_{OUT}$	MAX6325	+25°C	2.499	2.500	2.501	V
Output Voltage Temperature Coefficient (Note 1)	$TCV_{OUT}$	MAX6325C_A	C		0.5	1.0	ppm/°C
		MAX6325E_A	E		0.75	1.5	
		MAX6325MJA	M		1.0	2.5	
Line Regulation (Note 2)	$\Delta V_{OUT}/\Delta V_{IN}$	$8V \leq V_{IN} \leq 10V$	+25°C		10	18	ppm/V
			C			30	
			E			35	
		$10V \leq V_{IN} \leq 36V$	M			45	
			+25°C		2	5	
			C			7	
Load Regulation (Note 2)	$\Delta V_{OUT}/\Delta I_{OUT}$	Sourcing: $0mA \leq I_{OUT} \leq 15mA$	C		1	6	ppm/mA
			E		1	7	
			M		3	15	
		Sinking: $-15mA \leq I_{OUT} \leq 0mA$	C		1	6	
			E		1	7	
			M		10	30	
Supply Current	$I_{IN}$		+25°C		1.8	2.7	mA
			C, E, M			3.0	
Trim-Adjustment Range	$\Delta V_{OUT}$	(Figure 1)	C, E, M	±15	±25		mV
Turn-On Settling Time	$t_{ON}$	To ±0.01% of final value	+25°C		5		µs
Output Noise Voltage (Note 3)	$e_n$	$0.1Hz \leq f \leq 10Hz$	+25°C		1.5		µVp-p
		$10Hz \leq f \leq 1kHz$	+25°C		1.3	2.8	µV <sub>RMS</sub>
Temperature Hysteresis		(Note 4)	+25°C		20		ppm
Long-Term Stability	$\Delta V_{OUT}/t$		+25°C		30		ppm/1000hr

# MAX6325/MAX6341/MAX6350

## 1ppm/°C, Low-Noise, +2.5V/+4.096V/+5V Voltage References

### ELECTRICAL CHARACTERISTICS—MAX6341

( $V_{IN} = +10V$ ,  $I_{OUT} = 0mA$ ,  $T_A = T_{MIN}$  to  $T_{MAX}$ , unless otherwise noted. Typical values are at  $T_A = +25°C$ .)

PARAMETER	SYMBOL	CONDITIONS	$T_A$	MIN	TYP	MAX	UNITS
Input Voltage Range	$V_{IN}$		C, E, M	8		36	V
Output Voltage	$V_{OUT}$	MAX6341	+25°C	4.095	4.096	4.097	V
Output Voltage Temperature Coefficient (Note 1)	$TCV_{OUT}$	MAX6341C_A	C		0.5	1.0	ppm/°C
		MAX6341E_A	E		0.75	1.5	
		MAX6341MJA	M		1.0	2.5	
Line Regulation (Note 2)	$\frac{\Delta V_{OUT}}{\Delta V_{IN}}$	$8V \leq V_{IN} \leq 10V$	+25°C		10	18	ppm/V
			C			30	
			E			35	
		$10V \leq V_{IN} \leq 36V$	+25°C		2	5	
			C			7	
			E			8	
Load Regulation (Note 2)	$\frac{\Delta V_{OUT}}{\Delta I_{OUT}}$	Sourcing: $0mA \leq I_{OUT} \leq 15mA$	C		1	6	ppm/mA
			E		1	7	
			M		3	9	
		Sinking: $-15mA \leq I_{OUT} \leq 0mA$	C		1	6	
			E		1	7	
			M		7	18	
Supply Current	$I_{IN}$		+25°C		1.9	2.9	mA
			C, E, M			3.2	
Trim-Adjustment Range	$\Delta V_{OUT}$	(Figure 1)	C, E, M	±24	±40		mV
Turn-On Settling Time	$t_{ON}$	To ±0.01% of final value	+25°C		8		µs
Output Noise Voltage (Note 3)	$e_n$	$0.1Hz \leq f \leq 10Hz$	+25°C		2.4		µVp-p
		$10Hz \leq f \leq 1kHz$	+25°C		2.0	4.0	µVRMS
Temperature Hysteresis		(Note 4)	+25°C		20		ppm
Long-Term Stability	$\Delta V_{OUT}/t$		+25°C		30		ppm/ 1000hr

# MAX6325/MAX6341/MAX6350

## 1ppm/°C, Low-Noise, +2.5V/+4.096V/+5V Voltage References

### ELECTRICAL CHARACTERISTICS—MAX6350

( $V_{IN} = +10V$ ,  $I_{OUT} = 0mA$ ,  $T_A = T_{MIN}$  to  $T_{MAX}$ , unless otherwise noted. Typical values are at  $T_A = +25°C$ .)

PARAMETER	SYMBOL	CONDITIONS	$T_A$	MIN	TYP	MAX	UNITS
Input Voltage Range	$V_{IN}$		C, E, M	8		36	V
Output Voltage	$V_{OUT}$	MAX6350	+25°C	4.999	5.000	5.001	V
Output Voltage Temperature Coefficient (Note 1)	$TCV_{OUT}$	MAX6350C_A	C		0.5	1.0	ppm/°C
		MAX6350E_A	E		0.75	1.5	
		MAX6350MJA	M		1.0	2.5	
Line Regulation (Note 2)	$\Delta V_{OUT} / \Delta V_{IN}$	$8V \leq V_{IN} \leq 10V$	+25°C		10	18	ppm/V
			C			30	
			E			35	
			M			45	
		$10V \leq V_{IN} \leq 36V$	+25°C		2	5	
			C			7	
			E			8	
Load Regulation (Note 2)	$\Delta V_{OUT} / \Delta I_{OUT}$	Sourcing: $0mA \leq I_{OUT} \leq 15mA$	C		1	6	ppm/mA
			E		1	7	
			M		2	9	
		Sinking: $-15mA \leq I_{OUT} \leq 0mA$	C		1	6	
			E		1	7	
			M		6	15	
Supply Current	$I_{IN}$		+25°C		2.0	3.0	mA
			C, E, M			3.3	
Trim-Adjustment Range	$\Delta V_{OUT}$	(Figure 1)	C, E, M	±30	±50		mV
Turn-On Settling Time	$t_{ON}$	To ±0.01% of final value	+25°C		10		µs
Output Noise Voltage (Note 3)	$e_n$	$0.1Hz \leq f \leq 10Hz$	+25°C		3.0		µVp-p
		$10Hz \leq f \leq 1kHz$	+25°C		2.5	5.0	µVRMS
Temperature Hysteresis		(Note 4)	+25°C		20		ppm
Long-Term Stability	$\Delta V_{OUT}/t$		+25°C		30		ppm/1000hr

**Note 1:** Temperature coefficient is measured by the box method; i.e., the maximum  $\Delta V_{OUT}$  is divided by  $\Delta T \times V_{OUT}$ .

**Note 2:** Line regulation ( $\Delta V_{OUT} / (V_{OUT} \times \Delta V_{IN})$ ) and load regulation ( $\Delta V_{OUT} / (V_{OUT} \times \Delta I_{OUT})$ ) are measured with pulses and do not include output voltage changes due to die-temperature changes.

**Note 3:** Noise specifications are guaranteed by design.

**Note 4:** Temperature hysteresis is specified at  $T_A = +25°C$  by measuring  $V_{OUT}$  before and after changing temperature by +25°C, using the plastic DIP package.

# MAX6325/MAX6341/MAX6350

## 1ppm/°C, Low-Noise, +2.5V/+4.096V/+5V Voltage References

### Typical Operating Characteristics

( $V_{IN} = +10V$ ,  $I_{OUT} = 0mA$ ,  $T_A = +25^\circ C$ , unless otherwise noted.)

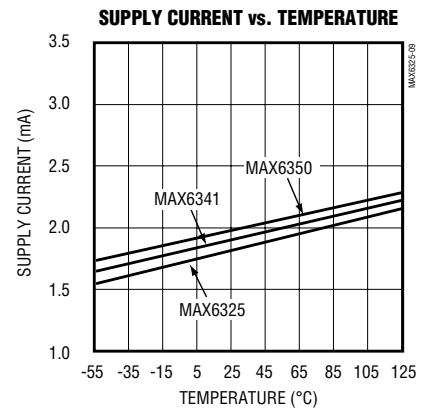
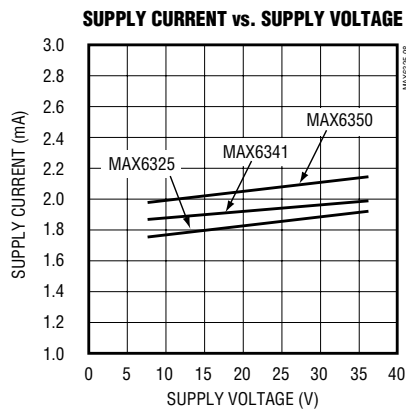
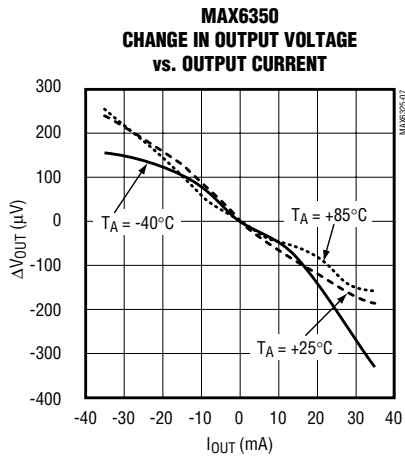
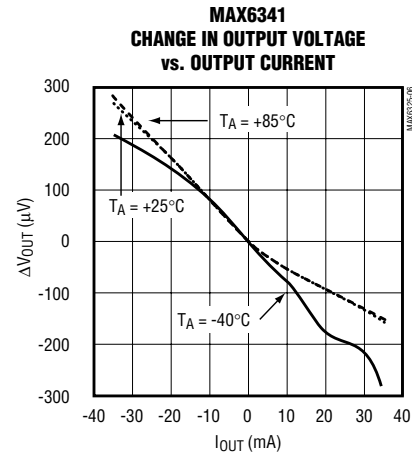
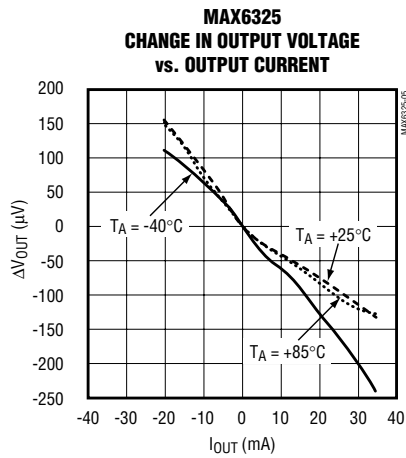
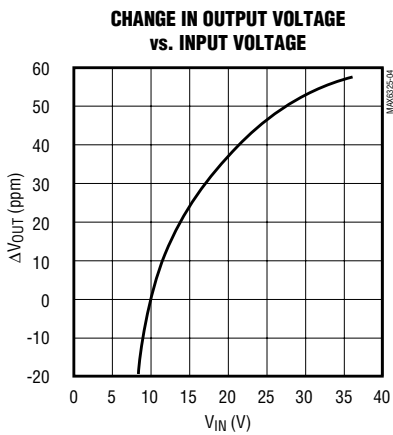
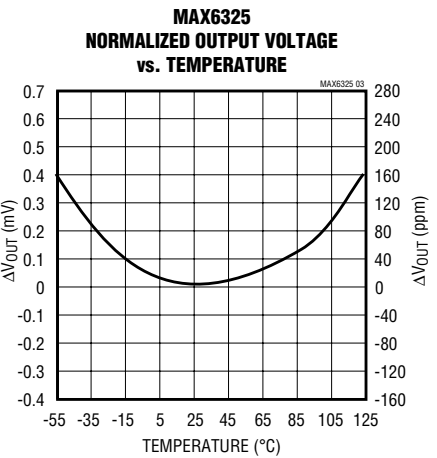
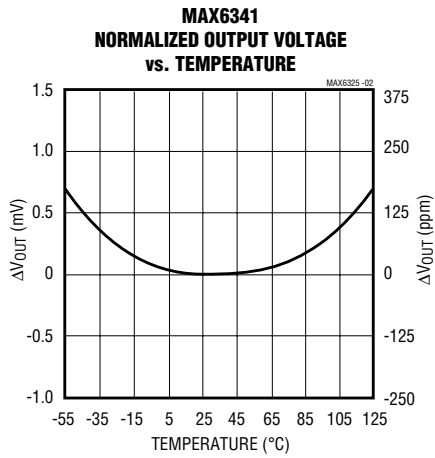
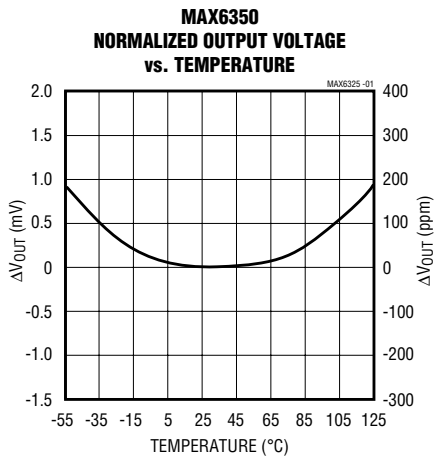

# MAX6325/MAX6341/MAX6350

## 1ppm/°C, Low-Noise, +2.5V/+4.096V/+5V Voltage References

### Typical Operating Characteristics (continued)

( $V_{IN} = +10V$ ,  $I_{OUT} = 0mA$ ,  $T_A = +25^\circ C$ , unless otherwise noted.)

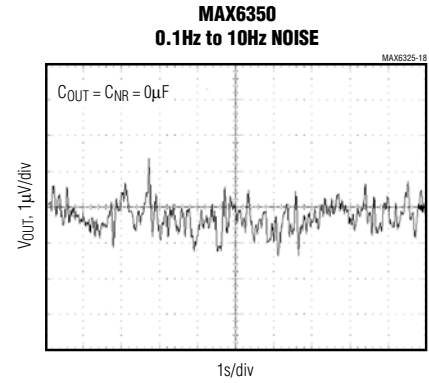
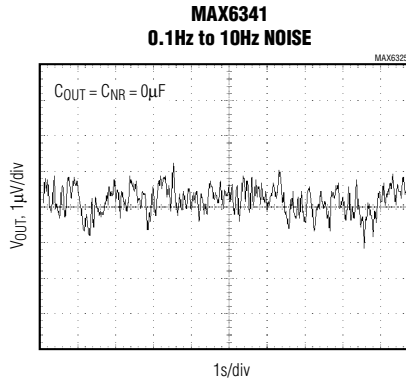
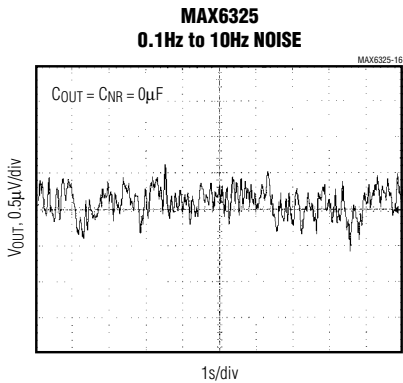
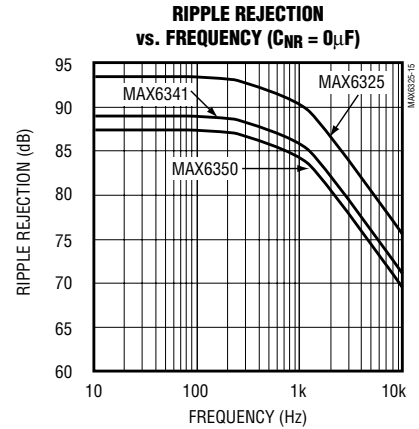
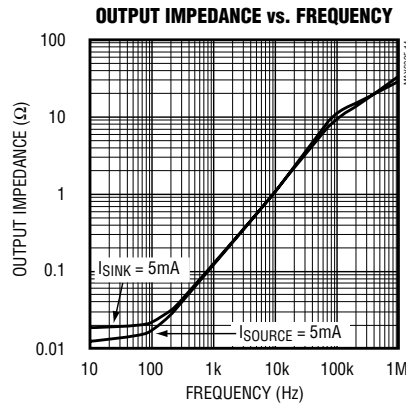
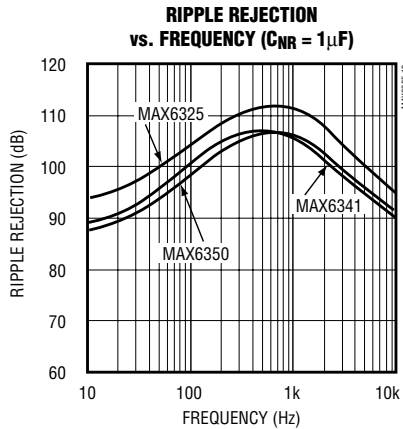
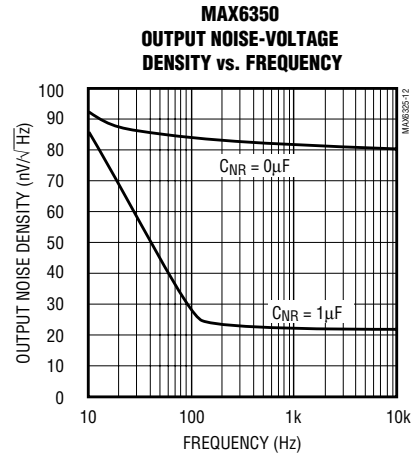
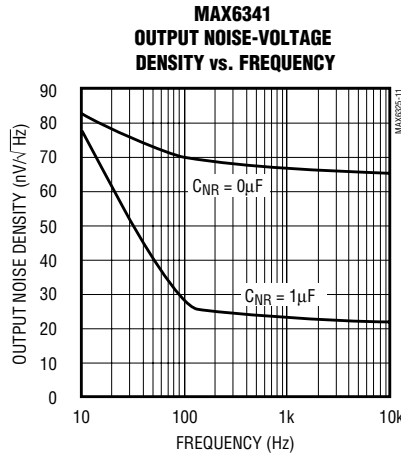
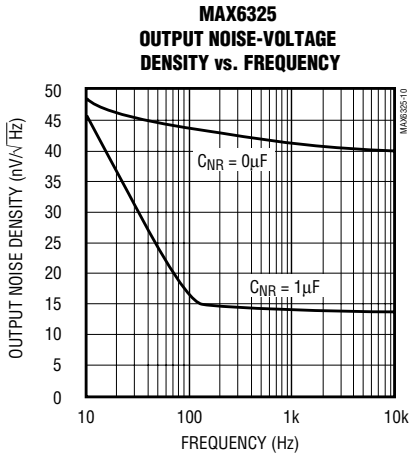

# MAX6325/MAX6341/MAX6350

## 1ppm/°C, Low-Noise, +2.5V/+4.096V/+5V Voltage References

### Typical Operating Characteristics (continued)

( $V_{IN} = +10V$ ,  $I_{OUT} = 0mA$ ,  $T_A = +25^\circ C$ , unless otherwise noted.)

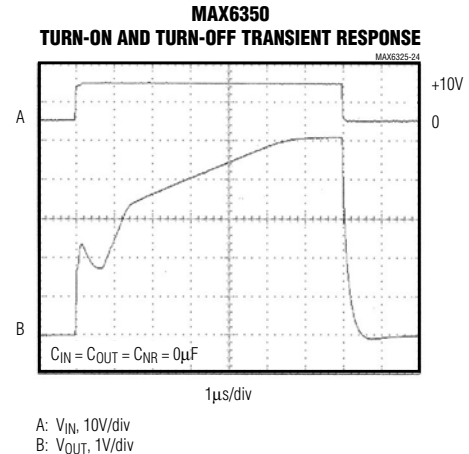
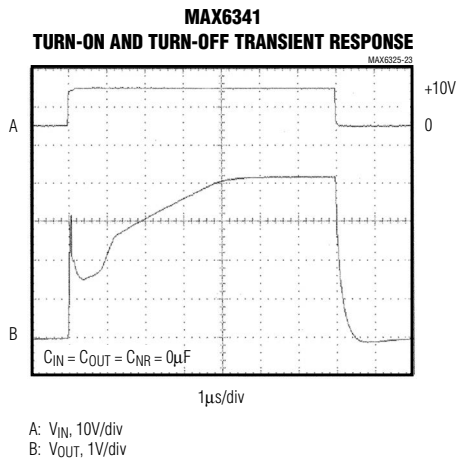
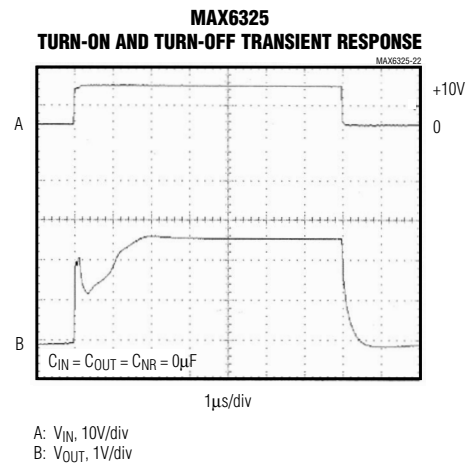
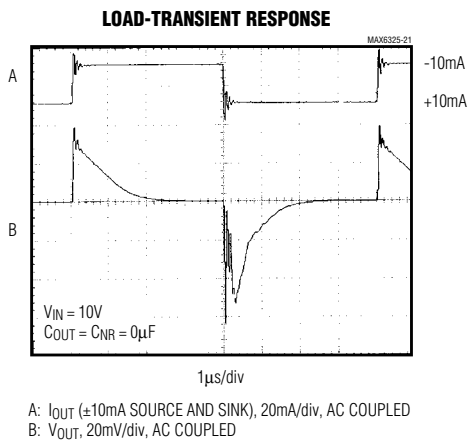
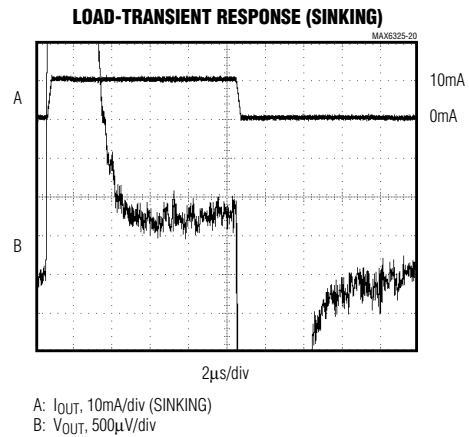
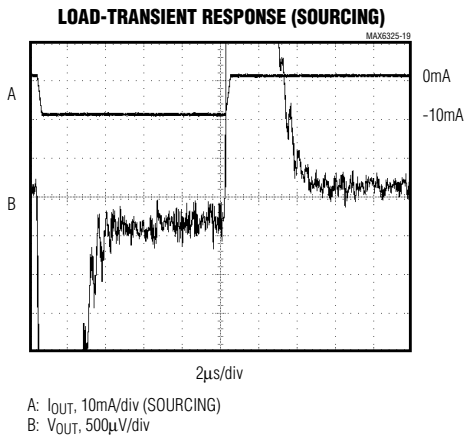

# MAX6325/MAX6341/MAX6350

## 1ppm/°C, Low-Noise, +2.5V/+4.096V/+5V Voltage References

### Pin Description

PIN	NAME	FUNCTION
1, 7, 8	I.C.	Internally Connected. <b>Do not use.</b>
2	IN	Positive Power-Supply Input
3	NR	Noise Reduction. Optional capacitor connection for wideband noise reduction. Leave open if not used (Figure 2).
4	GND	Ground
5	TRIM	External Trim Input. Allows $\pm 1\%$ output adjustment (Figure 1). Leave open if not used.
6	OUT	Voltage Reference Output

### Detailed Description

#### Temperature Stability

The MAX6325/MAX6341/MAX6350 are highly stable, low-noise voltage references that use a low-power temperature-compensation scheme to achieve laboratory-standard temperature stability. This produces a nearly flat temperature curve, yet does not require the power associated with heated references.

The output voltage can be trimmed a minimum of 0.6% by connecting a 10k $\Omega$  potentiometer between OUT and GND, and connecting its tap to the TRIM pin, as shown in Figure 1. The external trimming does not affect temperature stability.

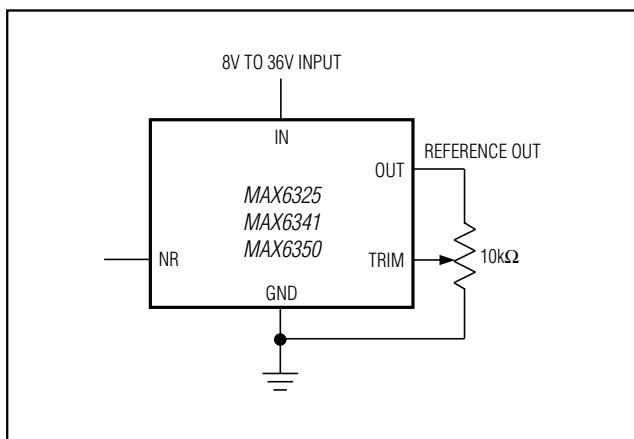

Figure 1. Output Voltage Adjustment

#### Noise Reduction

To augment wideband noise reduction, add a 1 $\mu$ F capacitor to the NR pin (Figure 2). Larger values do not improve noise appreciably (see *Typical Operating Characteristics*).

Noise in the power-supply input can affect output noise, but can be reduced by adding an optional bypass capacitor to the IN pin and GND.

#### Bypassing

The MAX6325/MAX6341/MAX6350 are stable with capacitive load values from 0 $\mu$ F to 100 $\mu$ F, for all values of load current. Adding an output bypass capacitor can help reduce noise and output glitching caused by load transients.

### Applications Information

#### Negative Regulator

Figure 3 shows how both a +5V and -5V precision reference can be obtained from a single, unregulated +5V supply. A MAX865 generates approximately  $\pm 9$ V to operate the MAX6350 reference and MAX400 inverting amplifier. The +5V is inverted by the ultra-low offset MAX400 op amp. Resistor R1 is optional, and may be used to trim the  $\pm 5$ V references. R2 and R4 should be matched, both in absolute resistance and temperature coefficient. R3 is optional, and is adjusted to set the -5V reference.

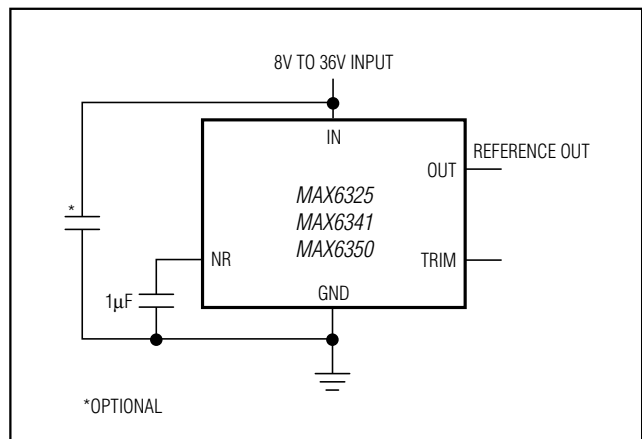

Figure 2. Noise-Reduction Capacitor

# MAX6325/MAX6341/MAX6350

## 1ppm/°C, Low-Noise, +2.5V/+4.096V/+5V Voltage References

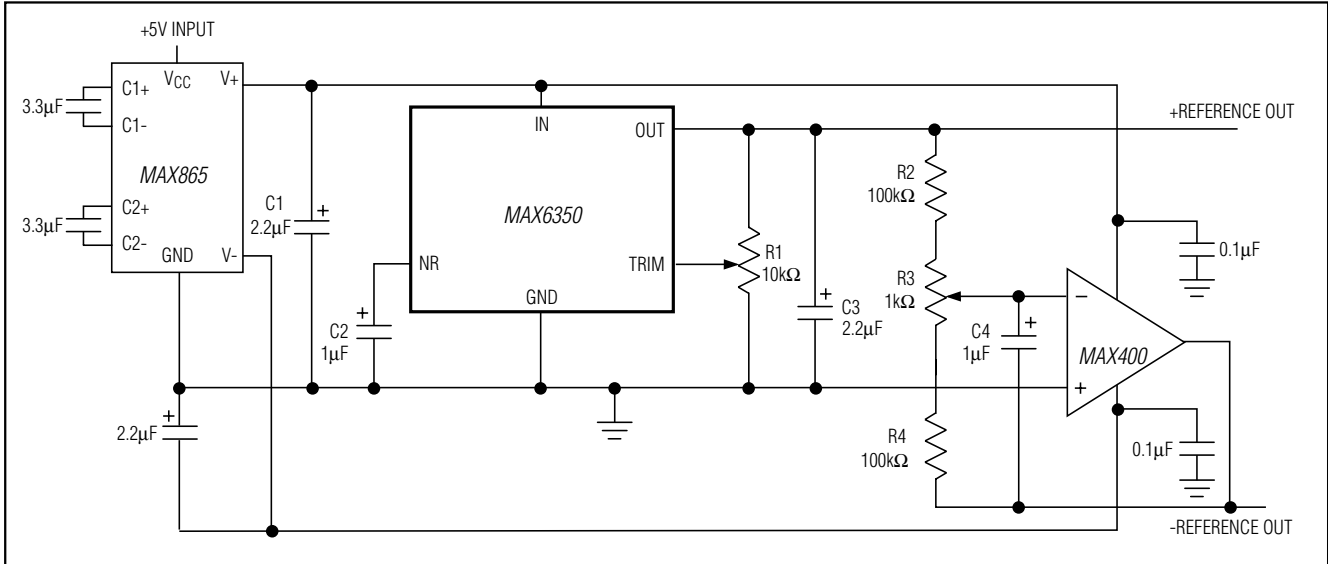

Figure 3. +5V and -5V References from a Single +5V Supply

### Ordering Information (continued)

PART	TEMP. RANGE	PIN-PACKAGE	MAX. TEMPCO (ppm/°C)
<b>MAX6341</b> CPA	0°C to +70°C	8 Plastic DIP	1.0
MAX6341CSA	0°C to +70°C	8 SO	1.0
MAX6341EPA	-40°C to +85°C	8 Plastic DIP	1.5
MAX6341ESA	-40°C to +85°C	8 SO	1.5
MAX6341MJA	-55°C to +125°C	8 CERDIP	2.5
<b>MAX6350</b> CPA	0°C to +70°C	8 Plastic DIP	1.0
MAX6350CSA	0°C to +70°C	8 SO	1.0
MAX6350EPA	-40°C to +85°C	8 Plastic DIP	1.5
MAX6350ESA	-40°C to +85°C	8 SO	1.5
MAX6350MJA	-55°C to +125°C	8 CERDIP	2.5

### Chip Information

TRANSISTOR COUNT: 435



# MAX6325/MAX6341/MAX6350

## 1ppm/°C, Low-Noise, +2.5V/+4.096V/+5V Voltage References

### Package Information

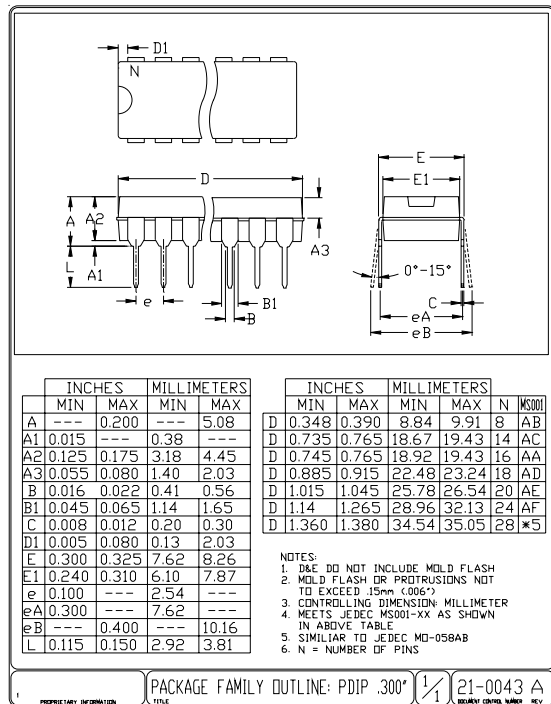
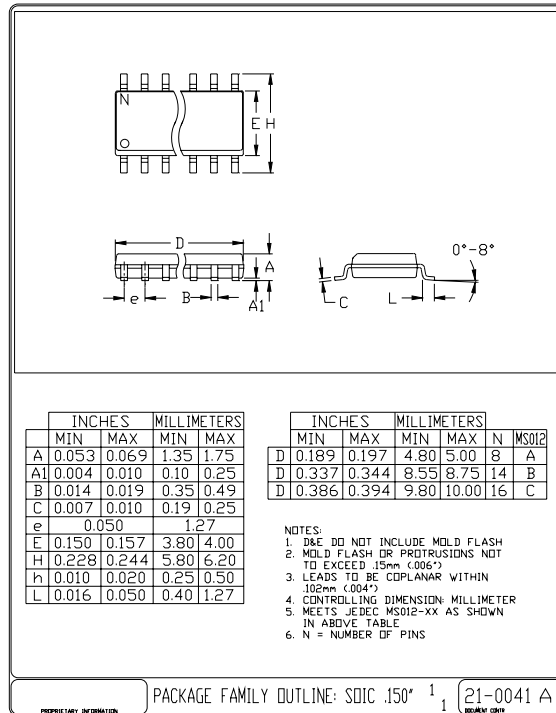

# MAX6325/MAX6341/MAX6350

## 1ppm/°C, Low-Noise, +2.5V/+4.096V/+5V Voltage References

### Package Information (continued)

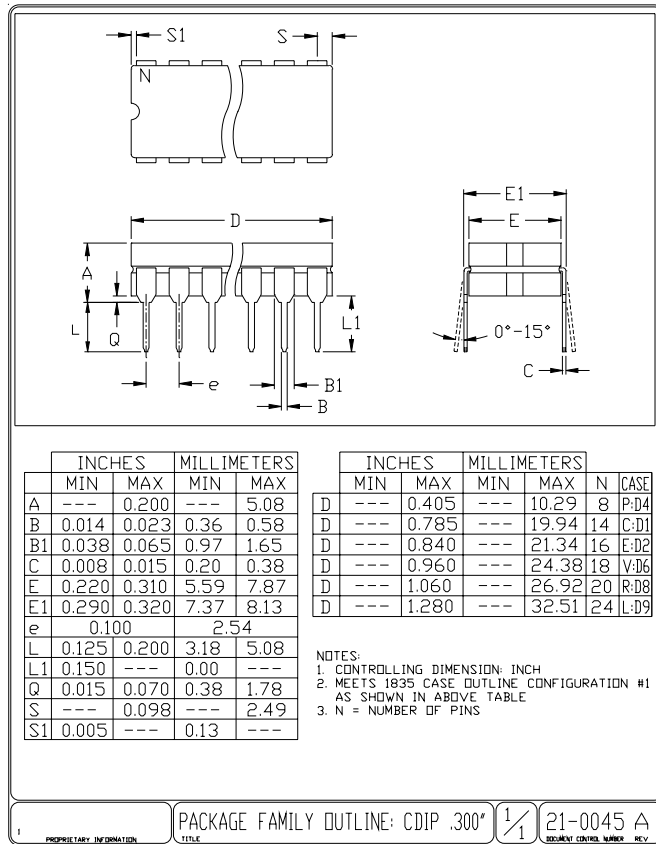

Maxim cannot assume responsibility for use of any circuitry other than circuitry entirely embodied in a Maxim product. No circuit patent licenses are implied. Maxim reserves the right to change the circuitry and specifications without notice at any time. The parametric values (min and max limits) shown in the Electrical Characteristics table are guaranteed. Other parametric values quoted in this data sheet are provided for guidance.

Maxim Integrated 160 Rio Robles, San Jose, CA 95134 USA 1-408-601-1000

11

# Mouser Electronics

Authorized Distributor

Click to View Pricing, Inventory, Delivery & Lifecycle Information:

## Maxim Integrated:

[MAX6325CPA+](#) [MAX6325CSA+T](#) [MAX6325EPA+](#) [MAX6325ESA+T](#) [MAX6341CPA+](#) [MAX6341EPA+](#)  
[MAX6341ESA+T](#) [MAX6350CPA+](#) [MAX6350CSA+T](#) [MAX6350EPA+](#) [MAX6350ESA+T](#) [MAX6341CSA+T](#)  
[MAX6325CSA+](#) [MAX6325ESA+](#) [MAX6341CSA+](#) [MAX6341ESA+](#) [MAX6350CSA+](#) [MAX6350ESA+](#) [MAX6350MJA](#)