

High-Efficiency, 26V Step-Up Converters for Two to Six White LEDs

ABSOLUTE MAXIMUM RATINGS

IN to GND	-0.3V to +6V
PGND to GND	-0.3V to +0.3V
LX, OUT to GND	-0.3V to +30V
CTRL to GND.....	-0.3V to the lower of +6V or (VIN + 2V)
COMP, CS to GND.....	-0.3 to (VIN + 0.3V)
ILX.....	1A

Continuous Power Dissipation (TA = +70°C) 3mm x 3mm 8-Pin TDFN (derate 24.4mW/°C above +70°C).....	1950mW
Operating Temperature Range	-40°C to +85°C
Junction Temperature	+150°C
Storage Temperature Range	-65°C to +150°C
Lead Temperature (soldering, 10s)	+300°C

Stresses beyond those listed under "Absolute Maximum Ratings" may cause permanent damage to the device. These are stress ratings only, and functional operation of the device at these or any other conditions beyond those indicated in the operational sections of the specifications is not implied. Exposure to absolute maximum rating conditions for extended periods may affect device reliability.

ELECTRICAL CHARACTERISTICS

(VIN = 3V, VOUT = 20V, COUT = 0.1µF, CCOMP = 0.15µF, RSENSE = 7.5Ω, VCTRL = 1.5V, Figure 1, TA = 0°C to +85°C, unless otherwise noted. Typical values are at TA = +25°C.)

PARAMETER	CONDITIONS	MIN	TYP	MAX	UNITS	
Supply Voltage		2.6		5.5	V	
UVLO Threshold	VIN rising or falling	2.10	2.38	2.55	V	
UVLO Hysteresis			40		mV	
Quiescent Current	No switching		0.38	0.55	mA	
Shutdown Supply Current	CTRL = GND, VOUT = VIN	TA = +25°C	0.3	2	µA	
		TA = +85°C	1			
OVLO Threshold	VOUT rising	26	27	29	V	
OVLO Hysteresis			2		V	
OUT Input Bias Current	VOUT = 26V, VCTRL > 0.24V	10	20	30	µA	
	VOUT = VIN, CTRL = GND		0.01	1		
Output Voltage Range	(Note 1)	(VIN - VD1)		25.5	V	
ERROR AMPLIFIER						
CTRL to CS Regulation	VCTRL = 1V, VIN = 2.6V to 5.5V	0.095	0.100	0.105	V	
CS Input Bias Current	VCS = VCTRL/10	TA = +25°C	0.01	1	µA	
		TA = +85°C	0.03			
CTRL Input Resistance	VCTRL ≤ 1.0V	290	500	780	kΩ	
CTRL Dual-Mode Threshold		100	170	240	mV	
CTRL Dual-Mode Hysteresis			5		mV	
CTRL Shutdown Enable Delay	(Note 2)	MAX1561	6.5	8.2	10.5	ms
		MAX1599	13.6	16.4	21.0	
CS-to-COMP Transconductance	VCOMP = 1.0V	32	50	82	µS	
OSCILLATOR						
Operating Frequency	MAX1561	0.80	1.0	1.25	MHz	
	MAX1599	0.4	0.5	0.6		
Minimum Duty Cycle	PWM mode		12		%	
	Pulse skipping		0			
Maximum Duty Cycle	CTRL = IN, CS = GND	91	94		%	

High-Efficiency, 26V Step-Up Converters for Two to Six White LEDs

MAX1561/MAX1599

ELECTRICAL CHARACTERISTICS (continued)

($V_{IN} = 3V$, $V_{OUT} = 20V$, $C_{OUT} = 0.1\mu F$, $C_{COMP} = 0.15\mu F$, $R_{SENSE} = 7.5\Omega$, $V_{CTRL} = 1.5V$, Figure 1, $T_A = 0^\circ C$ to $+85^\circ C$, unless otherwise noted. Typical values are at $T_A = +25^\circ C$.)

PARAMETER	CONDITIONS	MIN	TYP	MAX	UNITS
N-CHANNEL SWITCH					
LX On-Resistance	$I_{LX} = 190mA$		1.45	2.25	Ω
LX Leakage Current	$V_{LX} = 28V$, $CTRL = GND$	$T_A = +25^\circ C$	0.01	5	μA
		$T_A = +85^\circ C$	1		
LX Current Limit	Duty cycle = 90%	450	700	950	mA

ELECTRICAL CHARACTERISTICS

($V_{IN} = 3V$, $V_{OUT} = 20V$, $C_{OUT} = 0.1\mu F$, $C_{COMP} = 0.15\mu F$, $R_{SENSE} = 7.5\Omega$, $V_{CTRL} = 1.5V$, Figure 1, $T_A = -40^\circ C$ to $+85^\circ C$, unless otherwise noted.) (Note 3)

PARAMETER	CONDITIONS	MIN	TYP	MAX	UNITS
Supply Voltage		2.6		5.5	V
UVLO Threshold	V_{IN} rising or falling	2.10		2.55	V
Quiescent Current	No switching			0.55	mA
OVLO Threshold	V_{OUT} rising	26		29	V
OUT Input Bias Current	$V_{OUT} = 26V$, $V_{CTRL} > 0.24V$	10		30	μA
	$V_{OUT} = V_{IN}$, $CTRL = GND$			1	
Output Voltage Range	(Note 1)	$(V_{IN} - V_{D1})$		25.5	V
ERROR AMPLIFIER					
CTRL to CS Regulation	$V_{CTRL} = 1V$, $V_{IN} = 2.6V$ to $5.5V$	0.093		0.107	V
CTRL Input Resistance	$V_{CTRL} \leq 1.0V$	240		780	k Ω
CTRL Dual-Mode Threshold		100		240	mV
CTRL Shutdown Enable Delay	(Note 2)	MAX1561	6	11	ms
		MAX1599	13	22	
CS-to-COMP Transconductance	$V_{COMP} = 1.0V$	32		85	μS
OSCILLATOR					
Operating Frequency	MAX1561	0.75		1.25	MHz
	MAX1599	0.37		0.63	
Maximum Duty Cycle	$CTRL = IN$, $CS = GND$	91			%
N-CHANNEL SWITCH					
LX On-Resistance				2.25	Ω
LX Current Limit	Duty cycle = 90%	450		950	mA

Note 1: V_{D1} is the diode forward-voltage drop of diode D1 in Figure 1.

Note 2: Time from CTRL going below the dual-mode threshold to IC shutdown.

Note 3: Specifications to $-40^\circ C$ are guaranteed by design and not production tested.

High-Efficiency, 26V Step-Up Converters for Two to Six White LEDs

Typical Operating Characteristics

(Circuit of Figure 1, $V_{IN} = 3.6V$, $I_{LED} = 15mA$, $L1 = 22\mu H$, $C_{IN} = 2.2\mu F$, $C_{OUT} = 0.1\mu F$, $C_{COMP} = 0.1\mu F$, $R_{SENSE} = 7.5\Omega$, 4 LEDs, $T_A = +25^\circ C$, unless otherwise noted.)

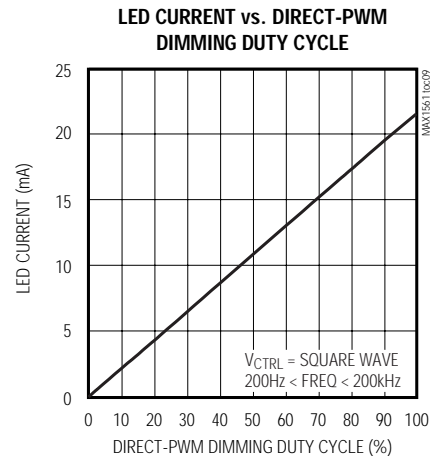
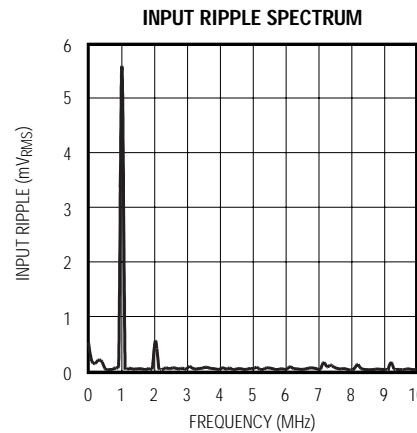
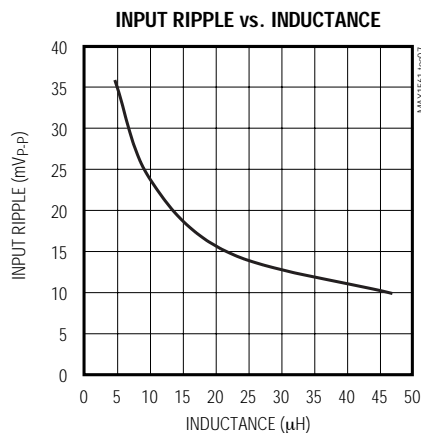
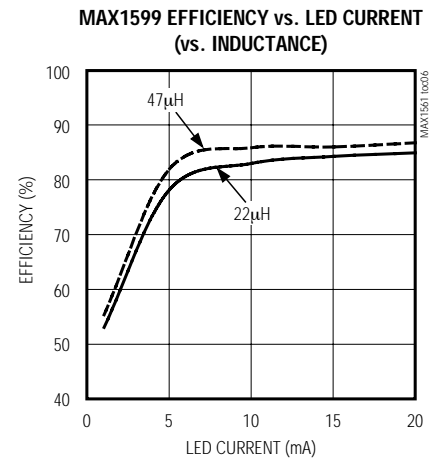
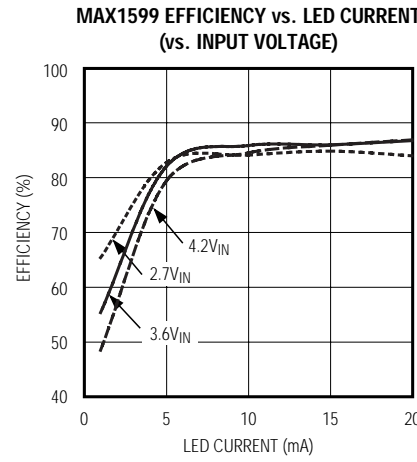
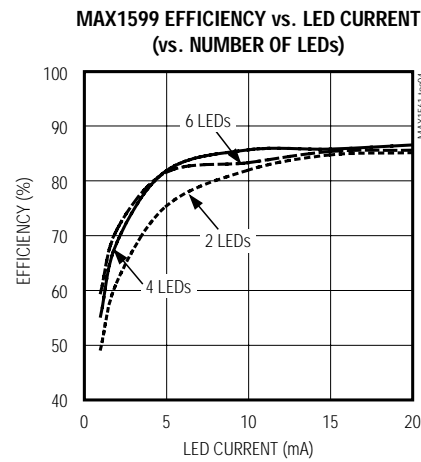
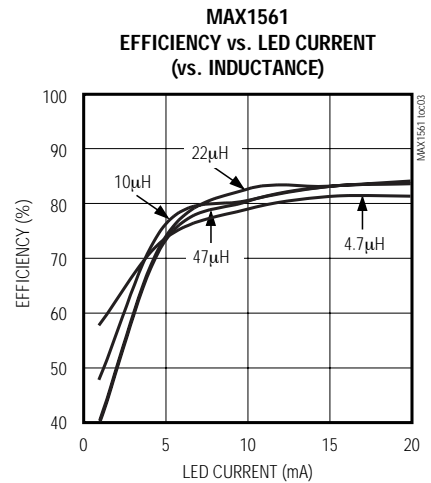
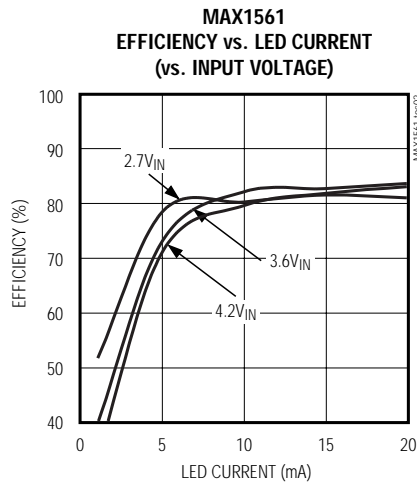
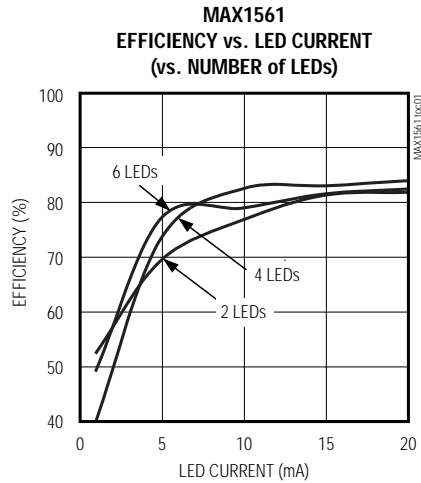

High-Efficiency, 26V Step-Up Converters for Two to Six White LEDs

MAX1561/MAX1599

Typical Operating Characteristics (continued)

(Circuit of Figure 1, $V_{IN} = 3.6V$, $I_{LED} = 15mA$, $L1 = 22\mu H$, $C_{IN} = 2.2\mu F$, $C_{OUT} = 0.1\mu F$, $C_{COMP} = 0.1\mu F$, $R_{SENSE} = 7.5\Omega$, 4 LEDs, $T_A = +25^\circ C$, unless otherwise noted.)

SWITCHING WAVEFORMS

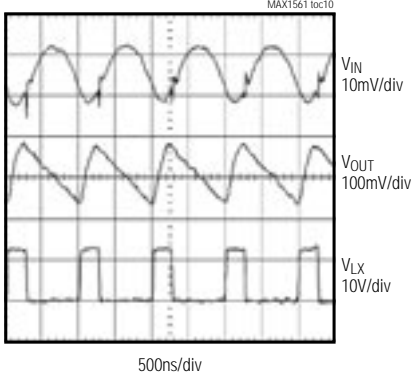

SOFT-START AND SHUTDOWN

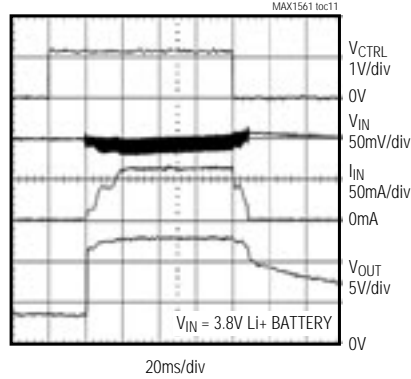

CTRL STEP RESPONSE

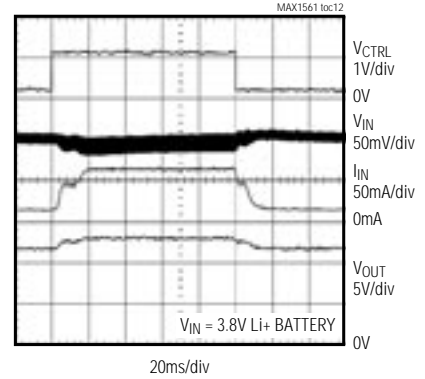

DIRECT-PWM DIMMING

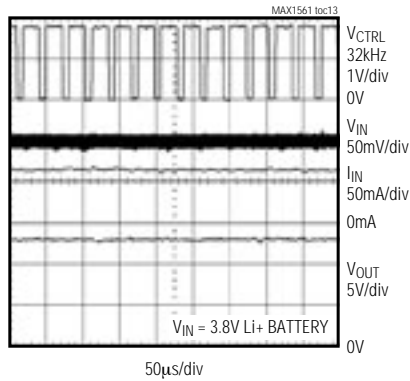

LINE-TRANSIENT RESPONSE

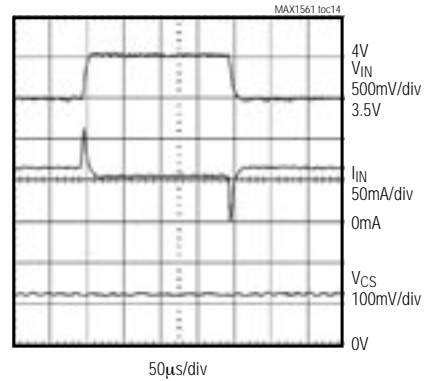

High-Efficiency, 26V Step-Up Converters for Two to Six White LEDs

Pin Description

PIN	NAME	FUNCTION
1	OUT	Overvoltage Sense. When V_{OUT} is greater than 27V, the internal N-channel MOSFET turns off until V_{OUT} drops below 25V, then the IC reenters soft-start. Connect a 0.1 μ F capacitor from OUT to PGND.
2	IN	Input Voltage Supply. Input voltage range is 2.6V to 5.5V. Connect a 2.2 μ F capacitor from IN to PGND.
3	CTRL	Brightness Control Input. LED brightness is controlled by the voltage applied to CTRL. Varying the voltage from 0.24V to 1.62V adjusts the brightness from dim to bright, respectively. Any voltage above 1.62V does not increase brightness. If CTRL is held below 100mV for more than 8.2ms (16.4ms for the MAX1599), the IC shuts down.
4	CS	Current-Sense Feedback Input. Connect a resistor from CS to GND to set the LED bias current. The voltage at CS regulates to $V_{CTRL} / 10$ or 0.162V, whichever is lower.
5	COMP	Compensation Input. Connect a 0.1 μ F capacitor (C_{COMP}) from COMP to GND. C_{COMP} stabilizes the converter and controls soft-start. C_{COMP} discharges to GND when in shutdown.
6	GND	Ground. Connect to PGND and the exposed pad directly under the IC.
7	PGND	Power Ground. Connect to GND and the exposed pad directly under the IC.
8	LX	Inductor Connection. This pin is high impedance during shutdown.
Exposed Pad	EP	Ground. Connect directly to GND and PGND under the IC.

Detailed Description

The MAX1561/MAX1599s' high efficiency and small size make them ideally suited to drive up to six series-connected LEDs. The device operates as a boost DC-DC converter that regulates output current rather than voltage. The MAX1561/MAX1599 provide even illumination by sourcing the same output current through each LED, eliminating the need for expensive factory calibration. The fast 1MHz (500kHz for the MAX1599) internal oscillator allows for a small inductor and small input and output capacitors while minimizing input and output ripple.

The single analog control input allows easy adjustment of LED brightness and on/off control. This allows either simple logic-level on/off control, analog voltage control, or PWM duty-cycle control of both brightness and shutdown. In shutdown, supply current is reduced to a low 0.3 μ A. A soft-start gradually illuminates the LEDs, eliminating the inrush current during startup.

Soft-Start

The MAX1561/MAX1599 attain soft-start by charging C_{COMP} gradually with a current source. When V_{COMP} rises above 1.25V, the internal MOSFET begins switching at a reduced duty cycle. When V_{COMP} rises above 2.25V, the duty cycle is at its maximum. See the *Typical Operating Characteristics* for an example of soft-start operation.

Shutdown

The MAX1561/MAX1599 enter shutdown when V_{CTRL} is less than 100mV for more than 8.2ms (16.4ms for the MAX1599). In shutdown, supply current is reduced to 0.3 μ A by powering down the entire IC except for the CTRL voltage-detection circuitry. C_{COMP} is discharged during shutdown, allowing the device to reinitiate soft-start when it is enabled. Although the internal N-channel MOSFET does not switch in shutdown, there is still a DC current path between the input and the LEDs through the inductor and Schottky diode. The minimum forward voltage of the LED array must exceed the maximum input voltage to ensure that the LEDs remain off in shutdown. However, with two or more LEDs, the forward voltage is large enough to keep leakage current low, less than 1 μ A (typ). Typical shutdown timing characteristics are shown in the *Typical Operating Characteristics*.

Overvoltage Protection

Overvoltage lockout (OVLO) occurs when V_{OUT} is above 27V. The protection circuitry stops the internal MOSFET from switching and causes V_{COMP} to decay to 0V. The device comes out of OVLO and into soft-start when V_{OUT} falls below 25V.

High-Efficiency, 26V Step-Up Converters for Two to Six White LEDs

MAX1561/MAX1599

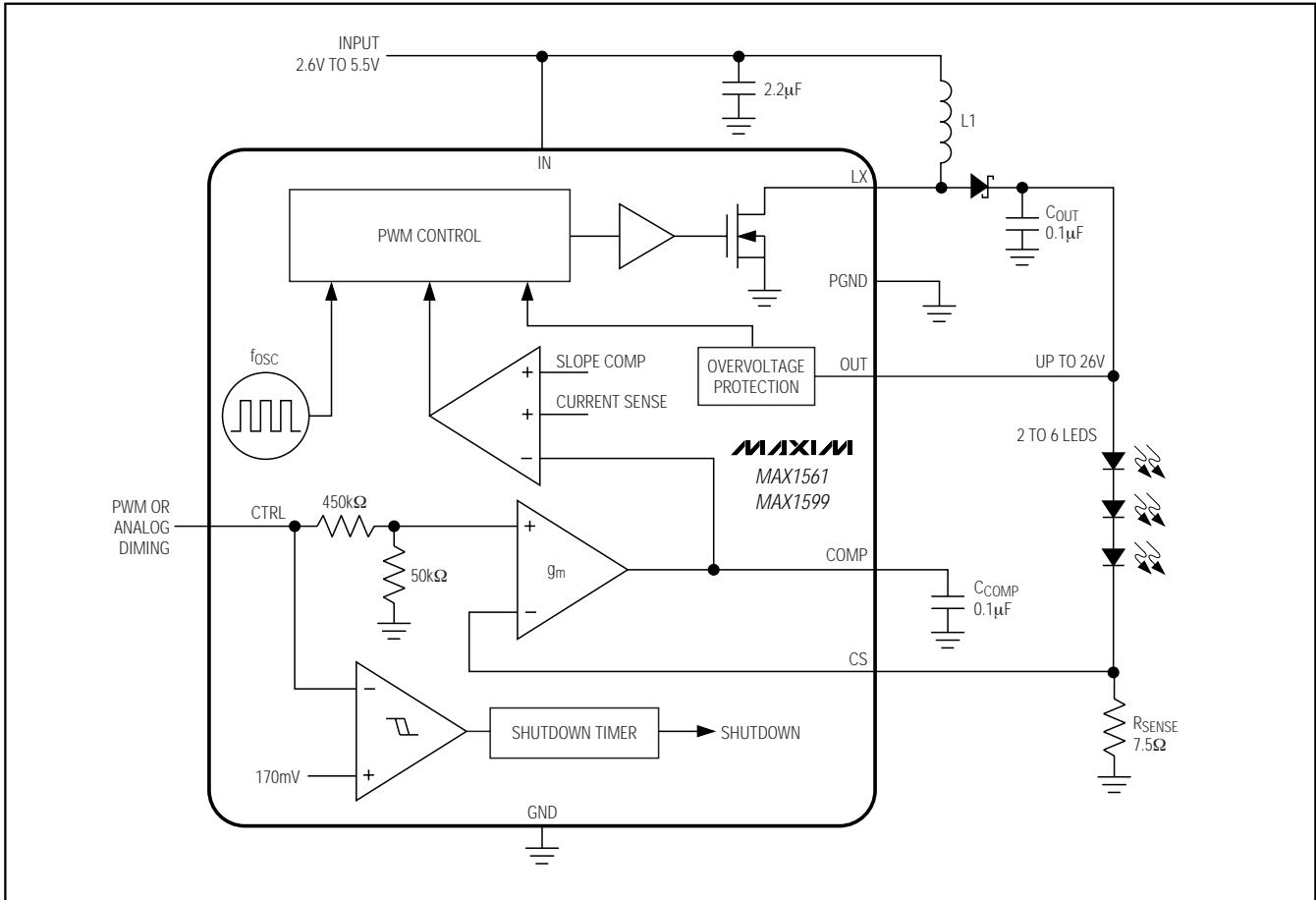

Figure 1. Functional Diagram

Design Procedure

Adjusting LED Current

Adjusting the MAX1561/MAX1599s' output current changes the brightness of the LEDs. An analog input (CTRL) and the sense-resistor value set the output current. Output current is given by:

$$I_{LED} = \frac{V_{CTRL}}{10 \times R_{SENSE}}$$

The V_{CTRL} voltage range for adjusting output current is 0.24V to 1.62V. To set the maximum current, calculate R_{SENSE} when V_{CTRL} is at its maximum as follows:

$$R_{SENSE} = \frac{1.62V}{10 \times I_{LED(MAX)}}$$

Power dissipation in R_{SENSE} is typically less than 5mW, making a standard chip resistor sufficient.

PWM Dimming Control

CTRL is also used as a digital input allowing LED brightness control with a logic-level PWM signal applied directly to CTRL. The frequency range is from 200Hz to 200kHz, while 0% duty cycle corresponds to zero current and 100% duty cycle corresponds to full current. The error amplifier and compensation capacitor form a lowpass filter so PWM dimming results in DC current to the LEDs without the need for any additional RC filters; see the *Typical Operating Characteristics*.

Capacitor Selection

The exact values of input and output capacitors are not critical. The typical value for the input capacitor is 2.2µF and the typical value for the output capacitor is 0.1µF. Larger value capacitors can be used to reduce

High-Efficiency, 26V Step-Up Converters for Two to Six White LEDs

input and output ripple, but at the expense of size and higher cost. C_{COMP} stabilizes the converter and controls soft-start. Connect a $0.1\mu\text{F}$ capacitor from COMP to GND. For stable operation, C_{OUT} must not exceed 10 times C_{COMP} .

Inductor Selection

Inductor values range from $10\mu\text{H}$ to $47\mu\text{H}$. A $22\mu\text{H}$ ($47\mu\text{H}$ for the MAX1599) inductor optimizes the efficiency for most applications while maintaining low $15\text{mV}_{\text{p-p}}$ input ripple. With input voltages near 5V , a larger value of inductance can be more efficient. To prevent core saturation, ensure that the inductor-saturation current rating exceeds the peak inductor current for the application. Calculate the peak inductor current with the following formula:

$$I_{\text{PEAK}} = \frac{V_{\text{OUT(MAX)}} \times I_{\text{LED(MAX)}}}{0.8 \times V_{\text{IN(MIN)}}} + \frac{V_{\text{IN(MIN)}} \times 0.8\mu\text{s}}{2 \times L}$$

Schottky Diode Selection

The MAX1561/MAX1599s' high switching frequency demands a high-speed rectification diode (D1) for optimum efficiency. A Schottky diode is recommended due to its fast recovery time and low forward-voltage drop. Ensure that the diode's average and peak current rating exceed the average output current and peak inductor current. In addition, the diode's reverse breakdown voltage must exceed V_{OUT} . The RMS diode current can be calculated from:

$$I_{\text{DIODE(RMS)}} \cong \sqrt{I_{\text{OUT}} \times I_{\text{PEAK}}}$$

Applications Information

PC Board Layout

Due to fast switching waveforms and high-current paths, careful PC board layout is required. An evaluation kit (MAX1561EVKIT) is available to speed design. Order MAX1599 samples separately.

When laying out a board, minimize trace lengths between the IC and R_{SENSE} , the inductor, the diode, the input capacitor, and the output capacitor. Keep traces short, direct, and wide. Keep noisy traces, such as the LX node trace, away from CS. The IN bypass capacitor (C_{IN}) should be placed as close to the IC as possible. PGND and GND should be connected directly to the exposed paddle underneath the IC. The ground connections of C_{IN} and C_{OUT} should be as close together as possible. The traces from IN to the inductor and from the Schottky diode to the LEDs may be longer.

Chip Information

TRANSISTOR COUNT: 2895

PROCESS: BiCMOS

High-Efficiency, 26V Step-Up Converters for Two to Six White LEDs

Package Information

(The package drawing(s) in this data sheet may not reflect the most current specifications. For the latest package outline information go to www.maxim-ic.com/packages.)

MAX1561/MAX1599

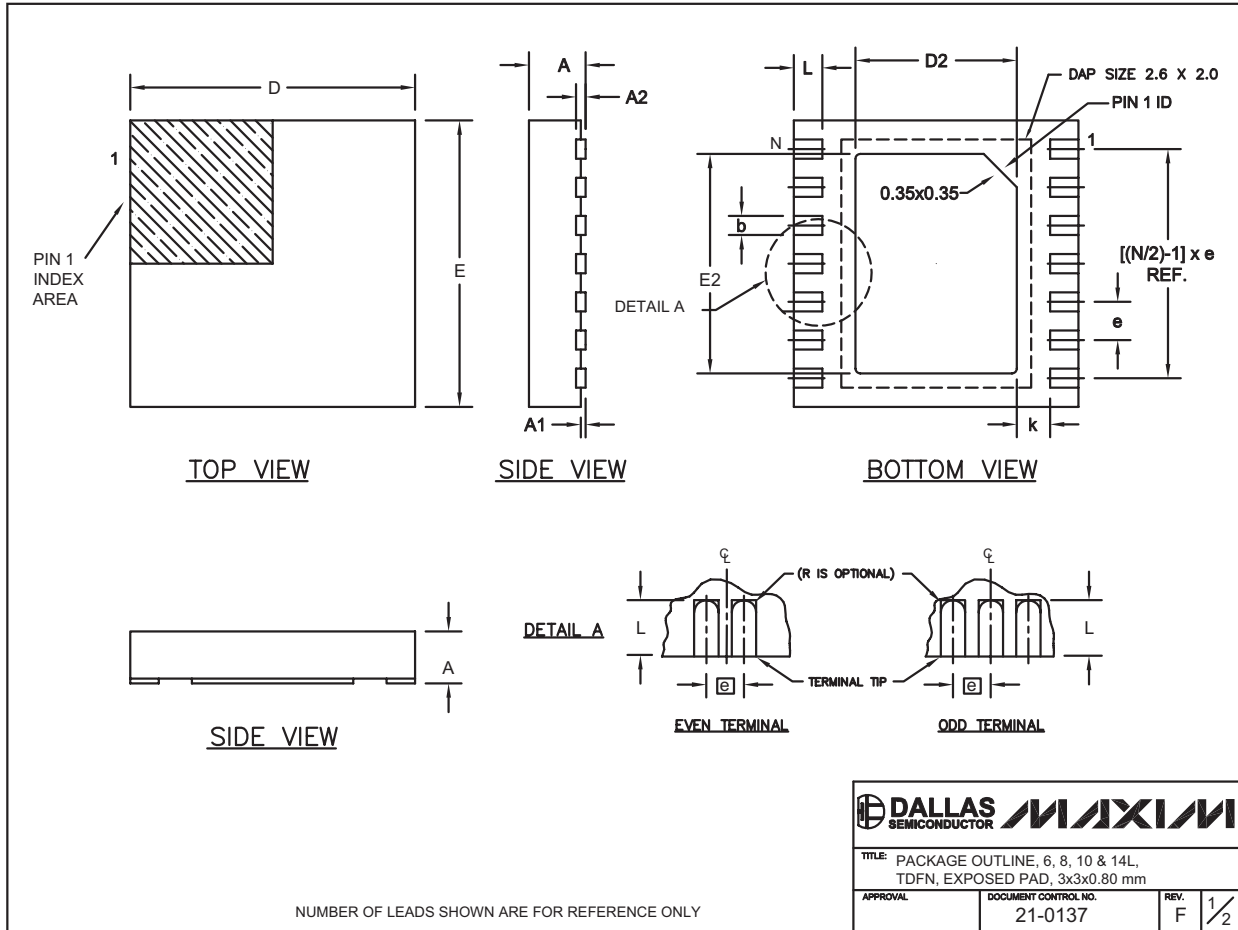

High-Efficiency, 26V Step-Up Converters for Two to Six White LEDs

Package Information (continued)

(The package drawing(s) in this data sheet may not reflect the most current specifications. For the latest package outline information go to www.maxim-ic.com/packages.)

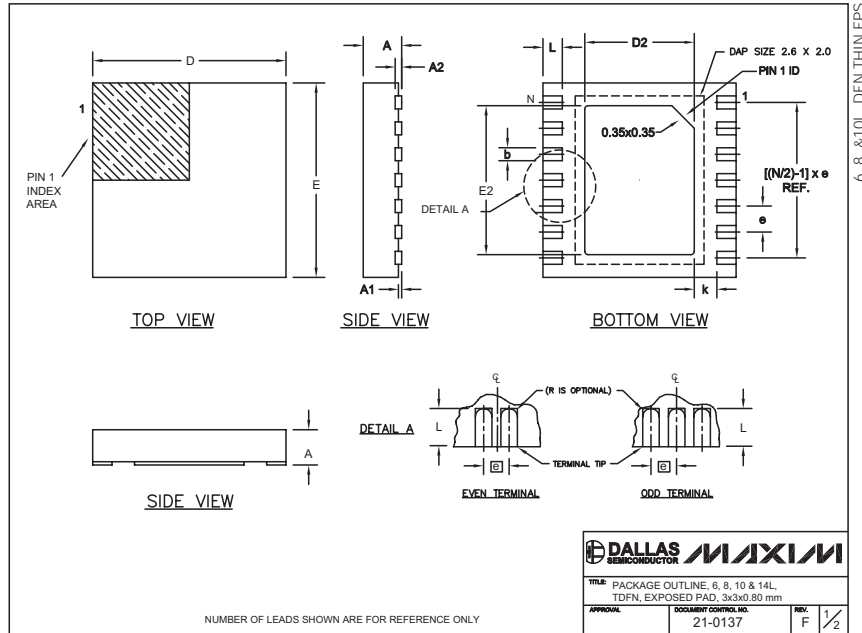

COMMON DIMENSIONS		
SYMBOL	MIN.	MAX.
A	0.70	0.80
D	2.90	3.10
E	2.90	3.10
A1	0.00	0.05
L	0.20	0.40
k	0.25 MIN.	
A2	0.20 REF.	

PACKAGE VARIATIONS							
PKG. CODE	N	D2	E2	e	JEDEC SPEC	b	[(N/2)-1] x e
T633-1	6	1.50±0.10	2.30±0.10	0.95 BSC	MO229 / WEEA	0.40±0.05	1.90 REF
T833-1	8	1.50±0.10	2.30±0.10	0.65 BSC	MO229 / WEEC	0.30±0.05	1.95 REF
T1033-1	10	1.50±0.10	2.30±0.10	0.50 BSC	MO229 / WEED-3	0.25±0.05	2.00 REF
T1433-1	14	1.70±0.10	2.30±0.10	0.40 BSC	----	0.20±0.03	2.40 REF
T1433-2	14	1.70±0.10	2.30±0.10	0.40 BSC	----	0.20±0.03	2.40 REF

- NOTES:
- ALL DIMENSIONS ARE IN mm. ANGLES IN DEGREES.
 - COPLANARITY SHALL NOT EXCEED 0.08 mm.
 - WARPAGE SHALL NOT EXCEED 0.10 mm.
 - PACKAGE LENGTH/PACKAGE WIDTH ARE CONSIDERED AS SPECIAL CHARACTERISTIC(S).
 - DRAWING CONFORMS TO JEDEC MO229, EXCEPT DIMENSIONS "D2" AND "E2", AND T1433-1 & T1433-2.
 - "N" IS THE TOTAL NUMBER OF LEADS.

APPROVAL: DALLAS SEMICONDUCTOR MAXIM

TITLE: PACKAGE OUTLINE, 6, 8, 10 & 14L, TDFN, EXPOSED PAD, 3x3x0.80 mm

APPROVAL: 21-0137 REV: F 1/2

Maxim cannot assume responsibility for use of any circuitry other than circuitry entirely embodied in a Maxim product. No circuit patent licenses are implied. Maxim reserves the right to change the circuitry and specifications without notice at any time.

10 _____ Maxim Integrated Products, 120 San Gabriel Drive, Sunnyvale, CA 94086 408-737-7600

Mouser Electronics

Authorized Distributor

Click to View Pricing, Inventory, Delivery & Lifecycle Information:

[Maxim Integrated:](#)

[MAX1561ETA+T](#) [MAX1599ETA+T](#)