

THIS PAGE INTENTIONALLY LEFT BLANK

Typical Applications

The HMC424LP3 / HMC424LP3E is ideal for:

- Basestation Infrastructure
- Fiber Optics & Broadband Telecom
- Microwave & VSAT Radios
- Military & Space
- Test Instrumentation

Features

- 0.5 dB LSB Steps to 31.5 dB
- Single Control Line Per Bit
- ± 0.5 dB Typical Bit Error
- 9mm² Leadless SMT Plastic Package

Functional Diagram

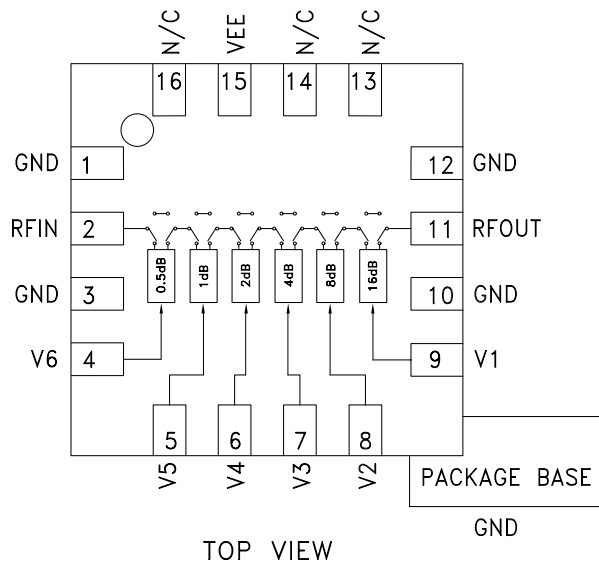

General Description

The HMC424LP3 & HMC424LP3E are broadband 6-bit GaAs IC digital attenuators in low cost leadless surface mount packages. Covering DC to 13 GHz, the insertion loss is less than 4 dB typical. The attenuator bit values are 0.5 (LSB), 1, 2, 4, 8, and 16 dB for a total attenuation of 31.5 dB. Attenuation accuracy is excellent at ± 0.5 dB typical step error with an IIP3 of +32 dBm. Six control voltage inputs, toggled between 0 and -5V, are used to select each attenuation state. A single Vee bias of -5V allows operation at frequencies down to DC.

Electrical Specifications, $T_A = +25^\circ C$, With Vee = -5V & VCTL= 0/-5V

| Parameter | Frequency (GHz) | Min. | Typ. | Max. | Units |
|--|----------------------|---------------------------------|------|------------------------------------|-------|
| Insertion Loss | DC - 4 GHz | | 3.1 | 3.8 | dB |
| | 4.0 - 8.0 GHz | | 3.5 | 4.0 | dB |
| | 8.0 - 13.0 GHz | | 4.0 | 4.6 | dB |
| Attenuation Range | DC - 13.0 GHz | | 31.5 | | dB |
| Return Loss (RF1 & RF2, All Atten. States) | DC - 13.0 GHz | 9 | 12 | | dB |
| Attenuation Accuracy: (Referenced to Insertion Loss) | 0.5 - 15.5 dB States | DC - 13.0 GHz | | ± (0.3 + 3% of Atten. Setting) Max | dB |
| | 16 - 31.5 dB States | DC - 13.0 GHz | | ± (0.3 + 5% of Atten. Setting) Max | dB |
| Input Power for 0.1 dB Compression | 1.0 - 13.0 GHz | | 22 | | dBm |
| Input Third Order Intercept Point (Two-Tone Input Power= 0 dBm Each Tone) | REF State | | 46 | | dBm |
| | All Other States | 1.0 - 13.0 GHz | 32 | | dBm |
| Switching Characteristics | DC - 13.0 GHz | | | | |
| | | tRISE, tFALL (10/90% RF) | | 30 | ns |
| | | tON/tOFF (50% CTL to 10/90% RF) | | 50 | ns |



0.5dB LSB GaAs MMIC 6-BIT DIGITAL ATTENUATOR, DC - 13 GHz

Insertion Loss

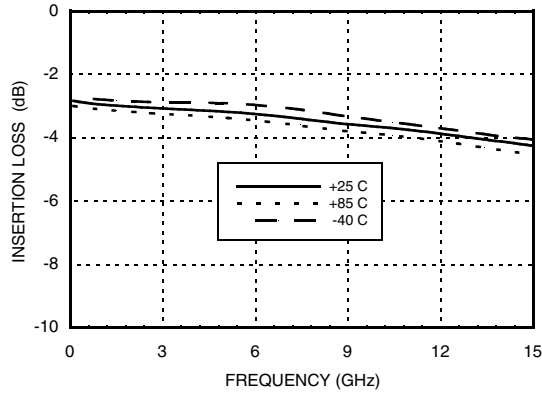

Return Loss RF1, RF2 (Only Major States are Shown)

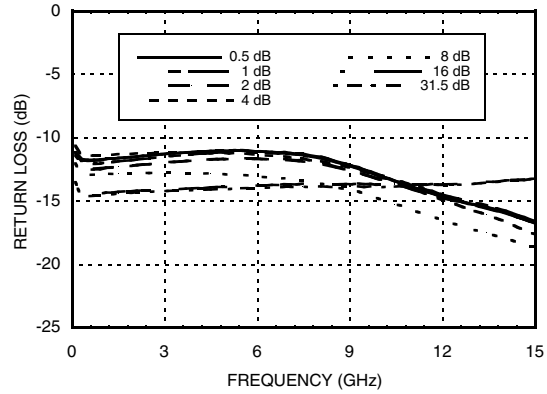

Normalized Attenuation (Only Major States are Shown)

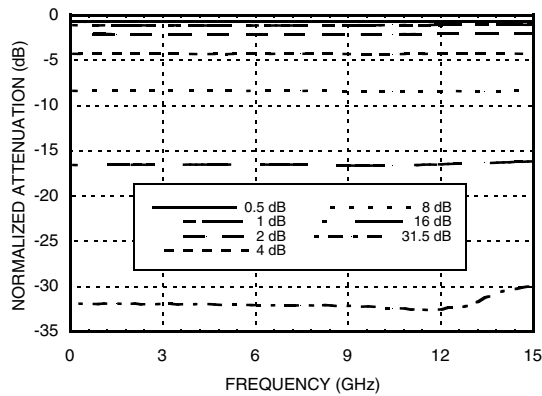

Bit Error vs. Attenuation State

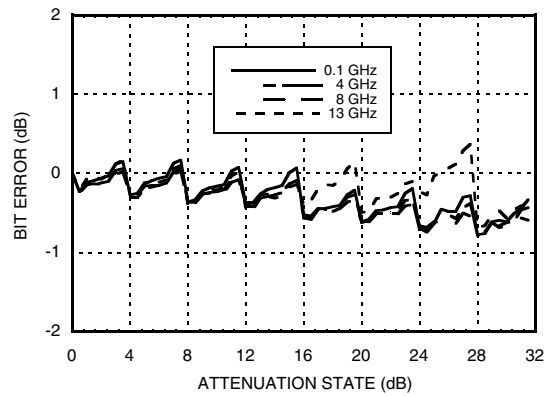

Bit Error vs. Frequency (Only Major States are Shown)

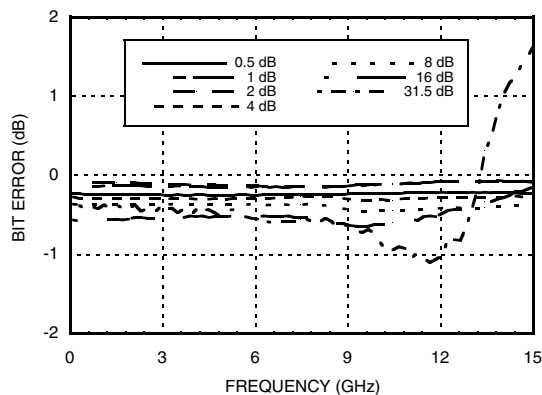

Relative Phase vs. Frequency (Only Major States are Shown)

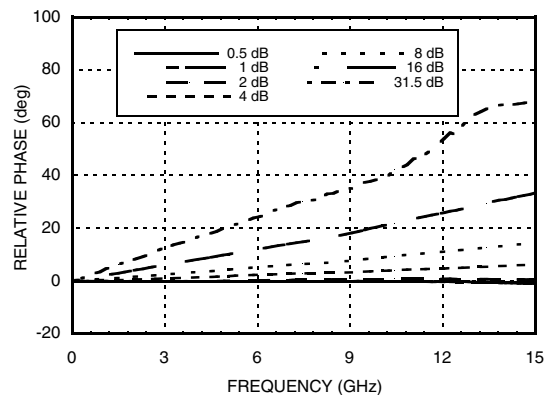



0.5dB LSB GaAs MMIC 6-BIT DIGITAL ATTENUATOR, DC - 13 GHz

Worst Case Step Error Between Successive Attenuation States

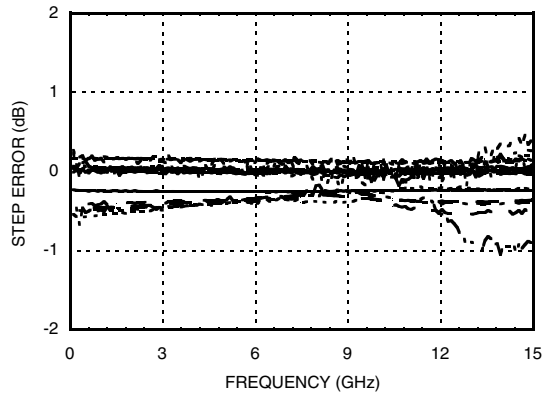

Bias Voltage & Current

| Vee Range= -5 Vdc ± 10% | | |
|-------------------------|-----------------|-----------------|
| Vee (VDC) | Iee (Typ.) (mA) | Iee (Max.) (mA) |
| -5 | 2 | 5 |

Control Voltage

| State | Bias Condition |
|-------|------------------------------|
| Low | 0 to -3V @ 35 µA Typ. |
| High | Vee to Vee +0.8V @ 5 µA Typ. |

Truth Table

| Control Voltage Input | | | | | | Attenuation State RF1 - RF2 |
|-----------------------|------------|------------|------------|------------|--------------|--------------------------------|
| V1 16 dB | V2 8 dB | V3 4 dB | V4 2 dB | V5 1 dB | V6 0.5 dB | |
| Low | Low | Low | Low | Low | Low | Reference I.L. |
| Low | Low | Low | Low | Low | High | 0.5 dB |
| Low | Low | Low | Low | High | Low | 1 dB |
| Low | Low | Low | High | Low | Low | 2 dB |
| Low | Low | High | Low | Low | Low | 4 dB |
| Low | High | Low | Low | Low | Low | 8 dB |
| High | Low | Low | Low | Low | Low | 16 dB |
| High | High | High | High | High | High | 31.5 dB |

Any Combination of the above states will provide an attenuation approximately equal to the sum of the bits selected.



0.5dB LSB GaAs MMIC 6-BIT DIGITAL ATTENUATOR, DC - 13 GHz

Absolute Maximum Ratings

| | |
|-------------------------------|-----------------|
| Control Voltage (V1 to V6) | Vee - 0.5 Vdc |
| Bias Voltage (Vee) | -7 Vdc |
| Channel Temperature | 150 °C |
| Thermal Resistance | 330 °C/W |
| Storage Temperature | -65 to + 150 °C |
| Operating Temperature | -55 to +85 °C |
| RF Input Power (0.5 - 13 GHz) | +25 dBm |



**ELECTROSTATIC SENSITIVE DEVICE
OBSERVE HANDLING PRECAUTIONS**

Outline Drawing

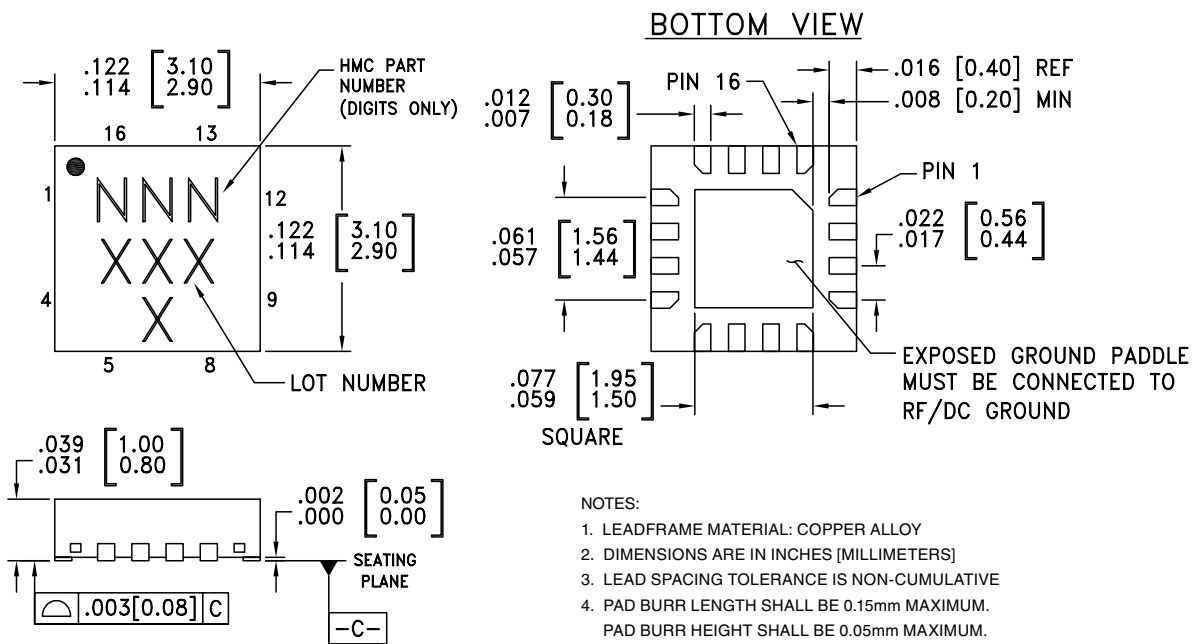

NOTES:

1. LEADFRAME MATERIAL: COPPER ALLOY
2. DIMENSIONS ARE IN INCHES [MILLIMETERS]
3. LEAD SPACING TOLERANCE IS NON-CUMULATIVE
4. PAD BURR LENGTH SHALL BE 0.15mm MAXIMUM. PAD BURR HEIGHT SHALL BE 0.05mm MAXIMUM.
5. PACKAGE WARP SHALL NOT EXCEED 0.05mm.
6. ALL GROUND LEADS AND GROUND PADDLE MUST BE SOLDERED TO PCB RF GROUND.
7. REFER TO HITTITE APPLICATION NOTE FOR SUGGESTED LAND PATTERN.

Package Information

| Part Number | Package Body Material | Lead Finish | MSL Rating | Package Marking ^[3] |
|-------------|--|---------------|---------------------|--------------------------------|
| HMC424LP3 | Low Stress Injection Molded Plastic | Sn/Pb Solder | MSL1 ^[1] | 424 XXXX |
| HMC424LP3E | RoHS-compliant Low Stress Injection Molded Plastic | 100% matte Sn | MSL1 ^[2] | 424 XXXX |

[1] Max peak reflow temperature of 235 °C



[2] Max peak reflow temperature of 260 °C

[3] 4-Digit lot number XXXX

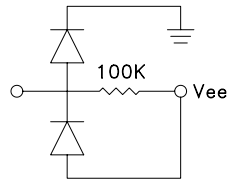

0.5dB LSB GaAs MMIC 6-BIT DIGITAL ATTENUATOR, DC - 13 GHz

Pin Description

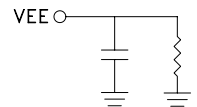
| Pad Number | Function | Description | Interface Schematic |
|------------------|-------------|---|---|
| 1, 3, 10, 12 | GND | Package bottom has an exposed metal paddle that must also be connected to RF ground |  |
| 2, 11 | RFIN, RFOUT | This pin is DC coupled and matched to 50 Ohm. Blocking capacitors are required if RF line potential is not equal to 0V. | |
| 4, 5, 6, 7, 8, 9 | V6 - V1 | See truth table and control voltage table. |  |
| 13, 14, 16 | N/C | This pin should be connected to PCB RF ground to maximize performance |  |
| 15 | VEE | Supply Voltage -5V ± 10% |  |

Suggested Driver Circuit (One Circuit Required Per Bit Control Input)

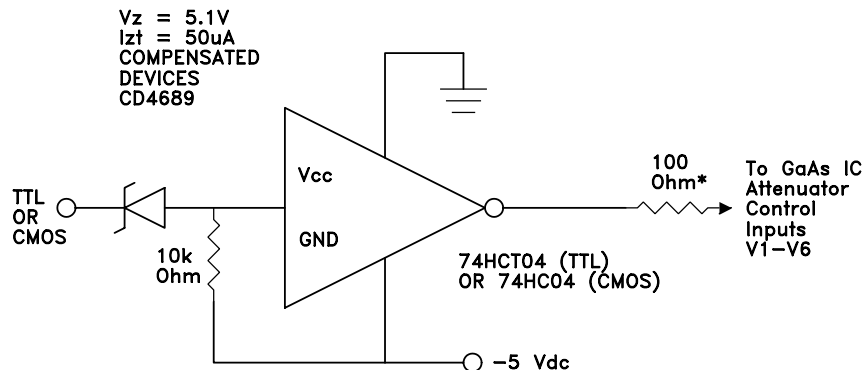

Simple driver using inexpensive standard logic ICs provides fast switching using minimum DC current.

* Recommended value to suppress unwanted RF signals at V1 - V6 control lines.

Evaluation PCB

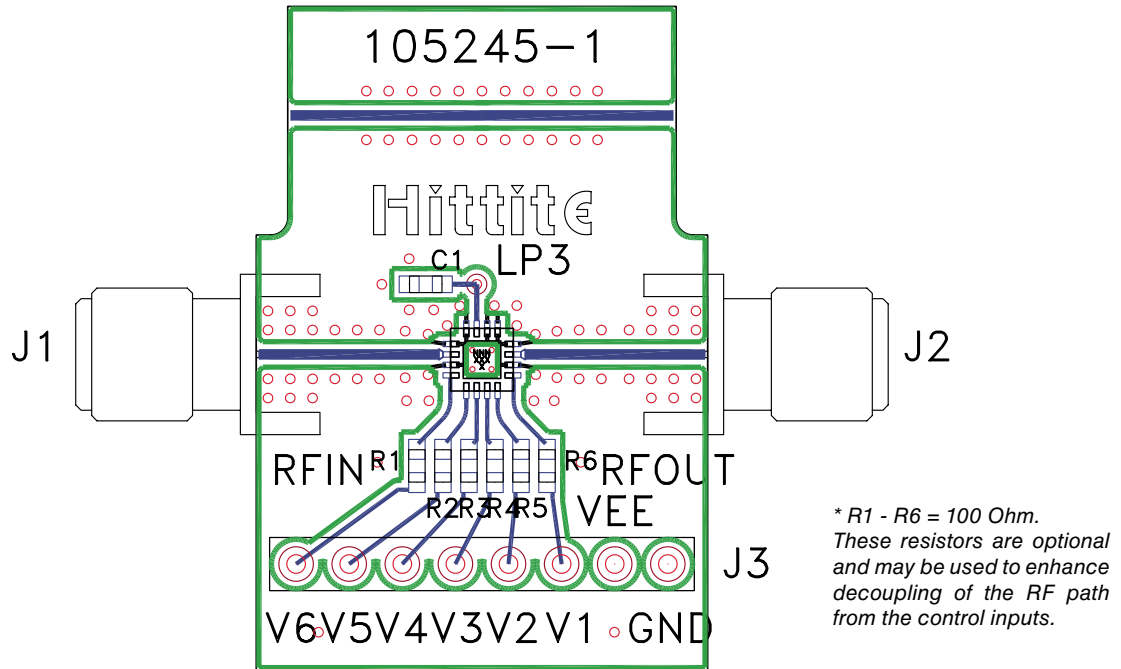

List of Materials for Evaluation PCB 105406 [1]

| Item | Description |
|---------|---|
| J1 - J2 | PCB Mount SMA Connector |
| J3 | 8 Pin DC Connector |
| C1 | 0.01 μ F Capacitor, 0603 Pkg. |
| R1 - R6 | 100 Ohm Resistor, 0603 Pkg. |
| U1 | HMC424LP3 / HMC424LP3E Digital Attenuator |
| PCB [2] | 105245 Evaluation PCB |

[1] Reference this number when ordering complete evaluation PCB

[2] Circuit Board Material: Rogers 4350

The circuit board used in the application should use RF circuit design techniques. Signal lines should have 50 Ohm impedance while the package ground leads and exposed paddle should be connected directly to the ground plane similar to that shown. A sufficient number of via holes should be used to connect the top and bottom ground planes. The evaluation circuit board shown is available from Hittite upon request.

Mouser Electronics

Authorized Distributor

Click to View Pricing, Inventory, Delivery & Lifecycle Information:

[Analog Devices Inc.:](#)

[HMC424LP3E](#) [HMC424LP3ETR](#) [HMC424LP3TR](#) [HMC424LP3](#)