

**Table 1. AA104-73/-73LF Signal Descriptions**

Pin #	Name	Description	Pin #	Name	Description
1	J1	RF port. Must be DC blocked.	4	V1	DC control bias
2	GND	RF ground. Must be AC-coupled to ground.	5	NC/GND	No connect or ground.
3	J2	RF port. Must be DC blocked.	6	V2	DC control bias

**Table 2. AA104-73/-73LF Absolute Maximum Ratings**

Parameter	Symbol	Minimum	Maximum	Units
RF input power	P <sub>IN</sub>		1 W > 500 MHz 0/8 V 0.5 W @ 50 MHz 0/8 V	dBm dBm
Supply voltage	V <sub>S</sub>		8	V
Control voltage	V <sub>CTL</sub>	-0.2	+8.0	V
Operating temperature	T <sub>OP</sub>	-40	+85	°C
Storage temperature	T <sub>STG</sub>	-65	+150	°C

**Note:** Exposure to maximum rating conditions for extended periods may reduce device reliability. There is no damage to device with only one parameter set at the limit and all other parameters set at or below their nominal value. Exceeding any of the limits listed here may result in permanent damage to the device.

---

**CAUTION:** Although this device is designed to be as robust as possible, Electrostatic Discharge (ESD) can damage this device. This device must be protected at all times from ESD. Static charges may easily produce potentials of several kilovolts on the human body or equipment, which can discharge without detection. Industry-standard ESD precautions should be used at all times.

---

**Electrical and Mechanical Specifications**

The absolute maximum ratings of the AA104-73/-73LF are provided in Table 2. Electrical specifications are provided in Tables 3, 4, 5, and 6.

Typical performance characteristics of the AA104-73/-73LF are illustrated in Figures 3 through 13.

The state of the AA104-73/-73LF is determined by the logic provided in Table 4.

**Table 3. AA104-73/-73LF Electrical Specifications (Note 1)****( $V_{CTL} = 0/3\text{ V}$  and  $0/5\text{ V}$ ,  $T_{OP} = -40\text{ }^{\circ}\text{C}$  to  $+85\text{ }^{\circ}\text{C}$ , Characteristic Impedance [ $Z_0$ ] =  $50\ \Omega$ , Unless Otherwise Noted)**

Parameter	Symbol	Test Condition (Note 2)	Min	Typical	Max	Units
Insertion loss	IL	0.0003 to 1.0 GHz		0.8	1.0	dB
		1.0 to 2.0 GHz		0.9	1.2	dB
		2.0 to 2.5 GHz		1.0	1.3	dB
Attenuation range		0.0003 to 1.0 GHz		32		dB
		1.0 to 2.0 GHz		27		dB
		2.0 to 2.3 GHz		24		dB
		2.3 to 2.5 GHz		23		dB
Attenuation accuracy (Note 3)		0.0003 to 0.5 GHz	$\pm (0.4 + 10\%$ of attenuation setting)			dB
		0.85 to 0.95 GHz	$\pm (0.4 + 5\%$ of attenuation setting)			dB
		1.7 to 2.0 GHz	$\pm (0.5 + 6\%$ of attenuation setting)			dB
		2.0 to 2.3 GHz	$\pm (0.6 + 7\%$ of attenuation setting)			dB
		2.3 to 2.5 GHz	$\pm (0.7 + 7\%$ of attenuation setting)			dB
Voltage Standing Wave Ratio (insertion loss state) (Note 4)	VSWR	0.0003 to 2.5 GHz		1.2:1	1.5:1	–
Voltage Standing Wave Ratio (attenuation state) (Note 4)	VSWR	0.0003 to 2.5 GHz		1.5:1	2.0:1	–
Switching characteristics: Rise/fall On/off Video feedthrough		10/90% or 90/10% RF		50		ns
		50% $V_{CTL}$ to 90/10% RF		100		ns
		$T_{RISE} = 1\text{ ns}$ , bandwidth = 500 MHz		25		mV
1 dB Input Compression Point	IP1dB	0.5 to 2.5 GHz, $V_{HIGH} = 3\text{ V}$	+14	+21		dBm
		0.5 to 2.5 GHz, $V_{HIGH} = 5\text{ V}$	+18	+23		dBm
3 <sup>rd</sup> Order Input Intercept Point	IIP3	For two-tone input, $P_{IN} = +10\text{ dBm/ tone}$ , 0.5 to 2.5 GHz				
		$V_{HIGH} = 3\text{ V}$	+36	+41	dBm	
		$V_{HIGH} = 5\text{ V}$	+38	+44	dBm	
Control voltages	$V_{CTL}$	$V_{CTL} = V_{LOW}$	0		0.2	V
		$V_{CTL} = V_{HIGH}$	3.0		5.0	V
Control port current	$I_{CTL}$	$V_{CTL} = V_{LOW}$			20	$\mu\text{A}$
		$V_{CTL} = 3\text{ V}$			100	$\mu\text{A}$
		$V_{CTL} = 5\text{ V}$			200	$\mu\text{A}$

**Note 1:** Performance is guaranteed only under the conditions listed in this Table.**Note 2:** Operates to 300 kHz when controlled with negative voltage. Bypass capacitor not required.**Note 3:** Attenuation value set by bypass capacitor. Attenuation referenced to insertion loss.**Note 4:** Input/output and in band.**Table 4. Compression Point vs Voltage and Temperature**

Control Voltage (V)	Temperature ( $^{\circ}\text{C}$ )	1 dB Compression Insertion Loss State (dBm)	1 dB Compression 32 dB State (dBm)
3	-40	+21	+16.5
3	+25	+21	+15.0
3	+85	+21	+14.0
5	-40	+22	+22.5
5	+25	+22	+22.5
5	+85	+22	+22.5

**Table 5. IIP3 vs Voltage and Temperature**

Control Voltage (V)	Temperature (°C)	IIP3 @ +10 dBm, Each Tone (dBm)
3	-40	+41
3	+25	+42
3	+85	+40
5	-40	+43
5	+25	+44
5	+85	+42

Two-tone input power: +10 dBm each tone.  
Tone frequencies: 500 and 501 MHz.

**Table 6. AA104-73/-73LF Truth Table**

Attenuation, J1 to J2	V1 (Pin 4)	V2 (Pin 6)
Insertion loss	V <sub>HIGH</sub>	0
32 dB	0	V <sub>HIGH</sub>

**Note:** V<sub>HIGH</sub> = +3 V to +5 V  
All other conditions not recommended.

### Typical Performance Characteristics

( $V_{CTL} = 0/5\text{ V}$ ,  $T_{OP} = -40\text{ }^{\circ}\text{C}$  to  $+25\text{ }^{\circ}\text{C}$ , Bypass Capacitor = 12 pF, Blocking Capacitor = 47 pF, Unless Otherwise Noted)

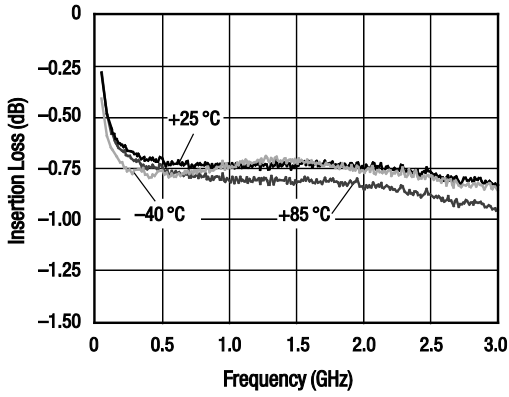

Figure 3. Insertion Loss vs Frequency

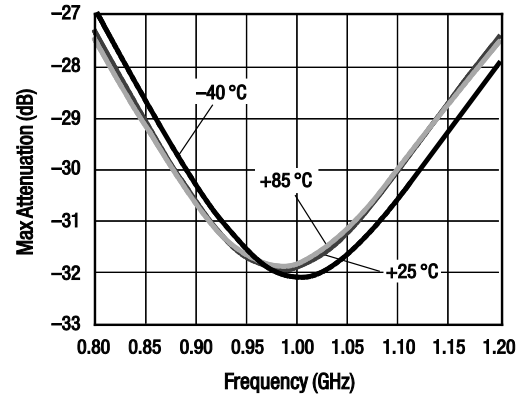

Figure 4. 32 dB State vs Frequency

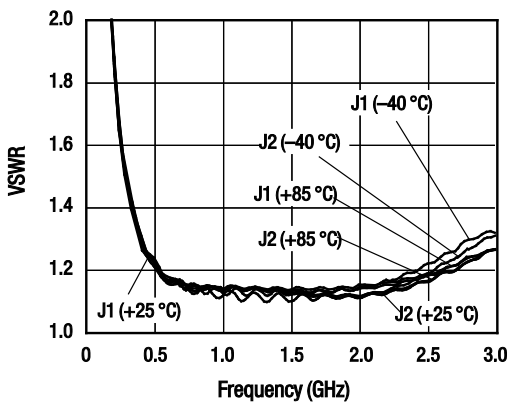

Figure 5. VSWR vs Frequency (Insertion Loss State)

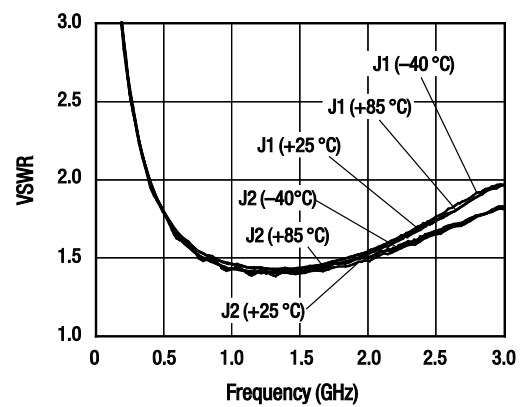

Figure 6. VSWR vs Frequency (32 dB State)

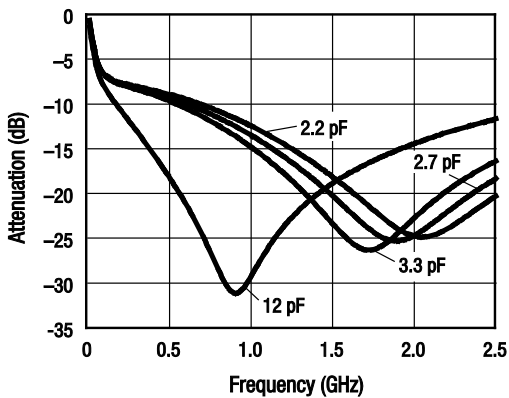

Figure 7. Attenuation vs Frequency, DC to 2.5 GHz (Bypass Capacitor = 2.2, 2.7, 3.3, and 12 pF)

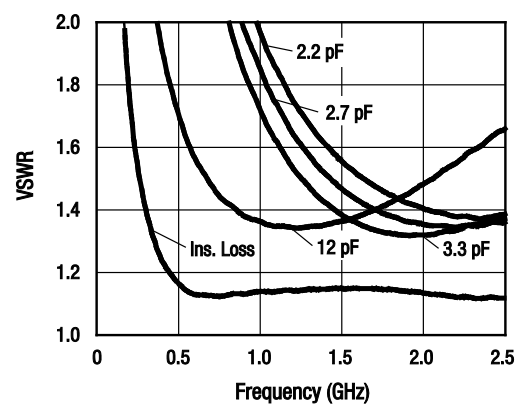
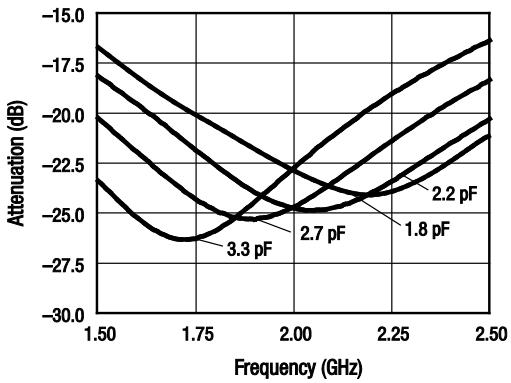
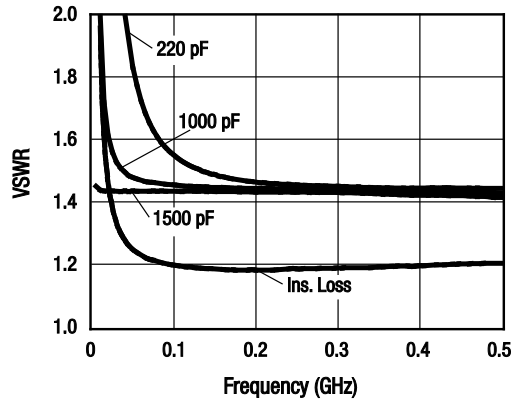

Figure 8. VSWR vs Frequency, DC to 2.5 GHz (Bypass Capacitor = 2.2, 2.7, 3.3, and 12 pF)



**Figure 9. Attenuation vs Frequency, 1.5 to 2.5 GHz (Bypass Capacitor = 2.2, 2.7, and 3.3 pF)**



**Figure 10. VSWR vs Frequency, DC to 0.5 GHz (Bypass Capacitor = 220, 1000, and 1500 pF)**

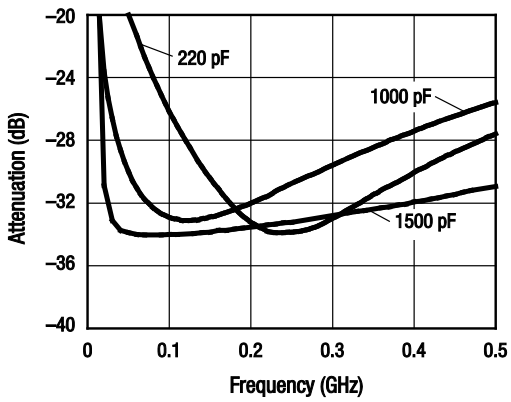

**Figure 11. Attenuation vs Frequency, DC to 0.5 GHz (Bypass Capacitor = 220, 1000, and 1500 pF)**

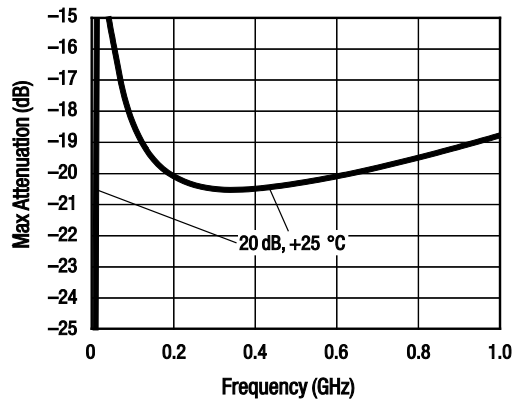

**Figure 12. 20 dB State vs Frequency (Bypass Capacitor = 100 pF, Blocking Capacitor = 220 pF, Bypass Resistor = 15 Ω)**

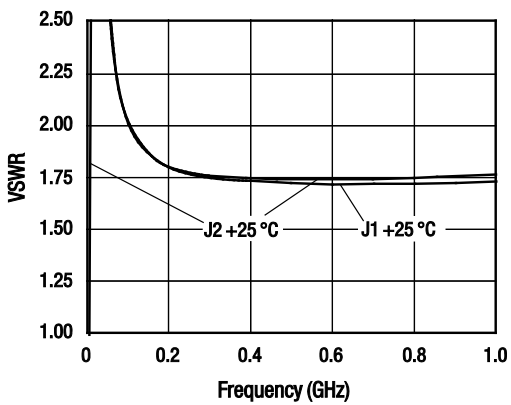

**Figure 13. VSWR vs Frequency (20 dB State)**

### Evaluation Board Description

The AA104-73/-73LF Evaluation Board is used to test the performance of the AA104-73/-73LF digital attenuator. An Evaluation Board schematic diagram is shown in Figure 14.

Table 7 provides a list of the blocking and bypass capacitor values that are used to produce operating frequencies between 0.015 and 2.5 GHz.

For 6-bit attenuator requirements, refer to the following Skyworks Application Notes:

*Six-Bit, 63 dB IF Digital Attenuator Solution, 1-500 MHz*  
(document #200622)

*Six-Bit, 63 dB RF Digital Attenuator Solution, 500-2000 MHz*  
(document #200623)

### Package and Handling Information

Instructions on the shipping container label regarding exposure to moisture after the container seal is broken must be followed. Otherwise, problems related to moisture absorption may occur when the part is subjected to high temperature during solder assembly.

THE AA104-73/-73LF is rated to Moisture Sensitivity Level 1 (MSL1) at 260 °C. It can be used for lead or lead-free soldering. For additional information, refer to the Skyworks Application Note, *Solder Reflow Information*, document number 200164.

Care must be taken when attaching this product, whether it is done manually or in a production solder reflow environment. Production quantities of this product are shipped in a standard tape and reel format.

### Package Dimensions

Package dimensions for the 6-pin SOT-6 are shown in Figure 15, and tape and reel dimensions are provided in Figure 16.

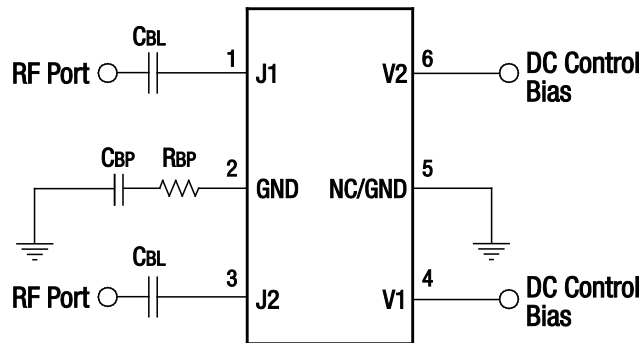

*Note: CBL = 47 pF for frequencies >500 MHz operation.  
CBL = 220 pF, CBP = 100 pF, RBP = 15 Ω,  
center frequency = 400 MHz. Center frequency  
and attenuation value can vary.*

S2352

**Figure 14. AA104-73/-73LF Evaluation Board Schematic Diagram**

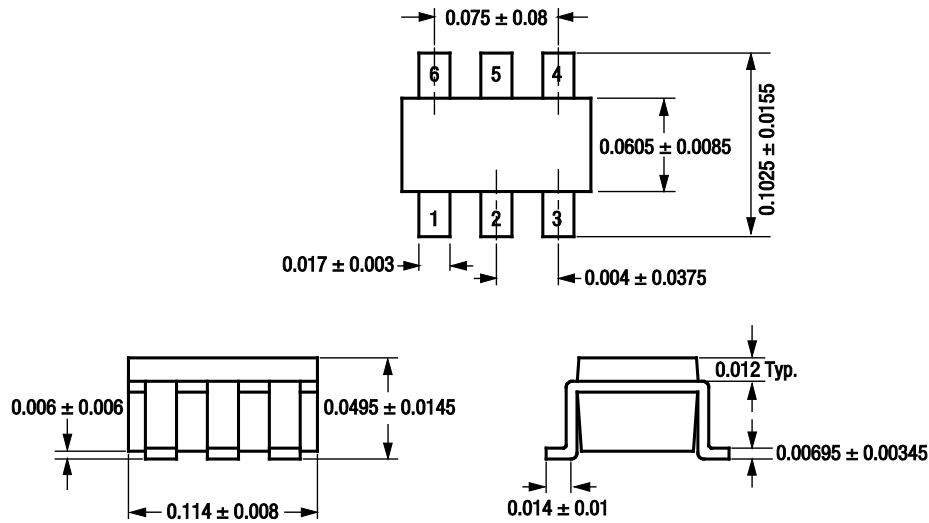

**Notes:**

1. Dimensions are in inches
2. Body length dimension does not include mold protrusions or gate burrs. Mold protrusions and gate must not exceed 0.005 in. per end. Body width dimension does not include interlead mold protrusions. Interlead mold protrusions must not exceed 0.005 in. per side.
3. Lead width dimension does not include dambar protrusion/intrusion. Allowable dambar protrusion must be 0.003 in. total in excess of lead width dimension at maximum material condition.
4. Details of pin 1 identifier are optional, but must be located within the zone indicated.
5. JEDEC standard practices and procedures apply (JEDEC Standard No. 95-1, Section 3).

S2961

**Figure 15. AA104-73/-73LF 5-Pin SOT-6 Package Dimensions**

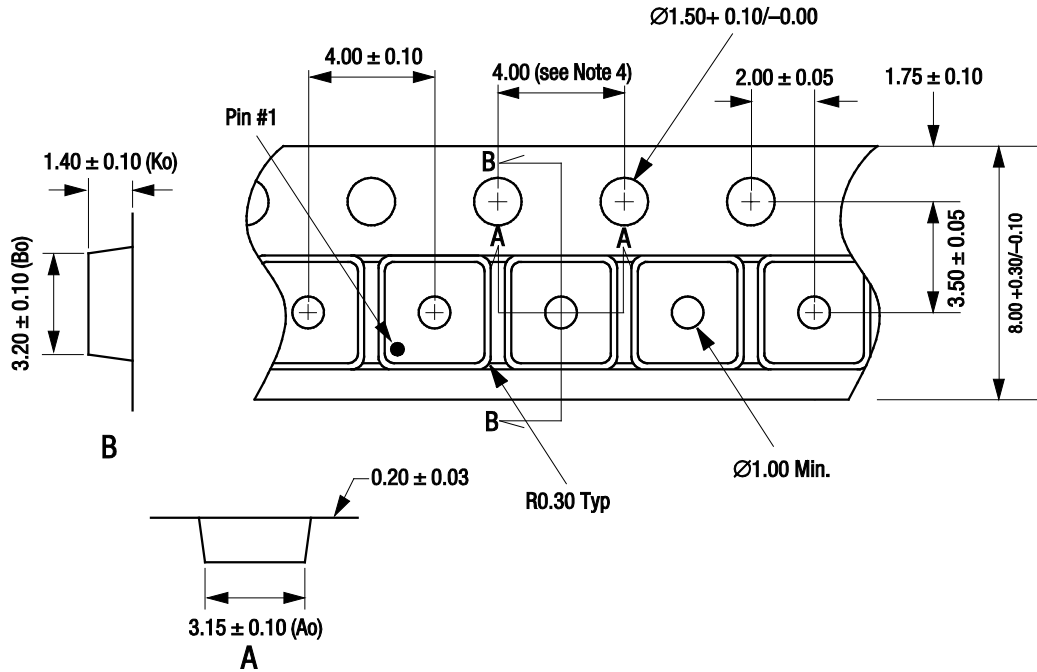

- Notes:
1. Carrier tape: black conductive polystyrene.
  2. Cover tape material: transparent conductive HSA.
  3. Cover tape size: 5.40 mm width.
  4. Ten sprocket hole pitch cumulative tolerance =  $\pm 0.20$  mm.
  5. All measurements are in millimeters.
  6. Standard reel size is 7 inches. Standard reel quantity is 3000 pcs.

S1681

Figure 16. AA104-73/-73LF Tape and Reel Dimensions



## Ordering Information

Model Name	Manufacturing Part Number	Evaluation Board Part Numbers
AA104-73/-73LF One-Bit Digital Attenuator	AA104-73/-73LF	AA104-73/-73LF-EVB

Copyright © 2002-2007, 2011, 2012 Skyworks Solutions, Inc. All Rights Reserved.

Information in this document is provided in connection with Skyworks Solutions, Inc. ("Skyworks") products or services. These materials, including the information contained herein, are provided by Skyworks as a service to its customers and may be used for informational purposes only by the customer. Skyworks assumes no responsibility for errors or omissions in these materials or the information contained herein. Skyworks may change its documentation, products, services, specifications or product descriptions at any time, without notice. Skyworks makes no commitment to update the materials or information and shall have no responsibility whatsoever for conflicts, incompatibilities, or other difficulties arising from any future changes.

No license, whether express, implied, by estoppel or otherwise, is granted to any intellectual property rights by this document. Skyworks assumes no liability for any materials, products or information provided hereunder, including the sale, distribution, reproduction or use of Skyworks products, information or materials, except as may be provided in Skyworks Terms and Conditions of Sale.

THE MATERIALS, PRODUCTS AND INFORMATION ARE PROVIDED "AS IS" WITHOUT WARRANTY OF ANY KIND, WHETHER EXPRESS, IMPLIED, STATUTORY, OR OTHERWISE, INCLUDING FITNESS FOR A PARTICULAR PURPOSE OR USE, MERCHANTABILITY, PERFORMANCE, QUALITY OR NON-INFRINGEMENT OF ANY INTELLECTUAL PROPERTY RIGHT; ALL SUCH WARRANTIES ARE HEREBY EXPRESSLY DISCLAIMED. SKYWORKS DOES NOT WARRANT THE ACCURACY OR COMPLETENESS OF THE INFORMATION, TEXT, GRAPHICS OR OTHER ITEMS CONTAINED WITHIN THESE MATERIALS. SKYWORKS SHALL NOT BE LIABLE FOR ANY DAMAGES, INCLUDING BUT NOT LIMITED TO ANY SPECIAL, INDIRECT, INCIDENTAL, STATUTORY, OR CONSEQUENTIAL DAMAGES, INCLUDING WITHOUT LIMITATION, LOST REVENUES OR LOST PROFITS THAT MAY RESULT FROM THE USE OF THE MATERIALS OR INFORMATION, WHETHER OR NOT THE RECIPIENT OF MATERIALS HAS BEEN ADVISED OF THE POSSIBILITY OF SUCH DAMAGE.

Skyworks products are not intended for use in medical, lifesaving or life-sustaining applications, or other equipment in which the failure of the Skyworks products could lead to personal injury, death, physical or environmental damage. Skyworks customers using or selling Skyworks products for use in such applications do so at their own risk and agree to fully indemnify Skyworks for any damages resulting from such improper use or sale.

Customers are responsible for their products and applications using Skyworks products, which may deviate from published specifications as a result of design defects, errors, or operation of products outside of published parameters or design specifications. Customers should include design and operating safeguards to minimize these and other risks. Skyworks assumes no liability for applications assistance, customer product design, or damage to any equipment resulting from the use of Skyworks products outside of stated published specifications or parameters.

Skyworks, the Skyworks symbol, and "Breakthrough Simplicity" are trademarks or registered trademarks of Skyworks Solutions, Inc., in the United States and other countries. Third-party brands and names are for identification purposes only, and are the property of their respective owners. Additional information, including relevant terms and conditions, posted at [www.skyworksinc.com](http://www.skyworksinc.com), are incorporated by reference.

# Mouser Electronics

Authorized Distributor

Click to View Pricing, Inventory, Delivery & Lifecycle Information:

[Skyworks:](#)

[AA104-73LF](#)