

Electrical Characteristics(Ta = 25°C)

Part Number	Marking Code	Zener Voltage			Operating resistance		Rising operating Resistance		Reverse current	
		V _Z (V)			ZZT(Ohm)		ZZK(Ohm)		IR(μA)	
		Min	Max	I _Z (mA)	Max	I _Z (mA)	Max	I _Z (mA)	Max	V _R (V)
CZRF52C2-HF	Z0	1.90	2.10	5	100	5	600	1	100	1
CZRF52C2V2-HF	Z1	2.09	2.31	5	100	5	600	1	100	1
CZRF52C2V4-HF	Z2	2.28	2.52	5	85	5	600	1	100	1
CZRF52C2V7-HF	Z3	2.57	2.84	5	83	5	500	1	75	1
CZRF52C3-HF	Z4	2.85	3.15	5	95	5	500	1	50	1
CZRF52C3V3-HF	Z5	3.14	3.47	5	95	5	500	1	25	1
CZRF52C3V6-HF	Z6	3.42	3.78	5	95	5	500	1	15	1
CZRF52C3V9-HF	Z7	3.71	4.10	5	95	5	500	1	10	1
CZRF52C4V3-HF	Z8	4.09	4.52	5	95	5	500	1	5	1
CZRF52C4V7-HF	Z9	4.47	4.94	5	78	5	500	1	5	2
CZRF52C5V1-HF	ZA	4.85	5.36	5	60	5	480	1	0.1	0.8
CZRF52C5V6-HF	ZB	5.32	5.88	5	40	5	400	1	0.1	1
CZRF52C6V2-HF	ZC	5.89	6.51	5	10	5	200	1	0.1	2
CZRF52C6V8-HF	ZE	6.46	7.14	5	8	5	150	1	0.1	3
CZRF52C7V5-HF	ZF	7.13	7.88	5	7	5	50	1	0.1	5
CZRF52C8V2-HF	ZG	7.79	8.61	5	7	5	50	1	0.1	6
CZRF52C9V1-HF	ZH	8.65	9.56	5	10	5	50	1	0.1	7
CZRF52C10-HF	ZJ	9.50	10.50	5	15	5	70	1	0.1	7.5
CZRF52C11-HF	ZK	10.45	11.55	5	20	5	70	1	0.1	8.5
CZRF52C12-HF	ZM	11.40	12.60	5	20	5	90	1	0.1	9
CZRF52C13-HF	ZN	12.35	13.65	5	25	5	110	1	0.1	10
CZRF52C15-HF	ZP	14.25	15.75	5	30	5	110	1	0.1	11
CZRF52C16-HF	ZQ	15.20	16.80	5	40	5	170	1	0.1	12
CZRF52C18-HF	ZR	17.10	18.90	5	50	5	170	1	0.1	14
CZRF52C20-HF	ZS	19.00	21.00	5	50	5	220	1	0.1	15
CZRF52C22-HF	ZT	20.90	23.10	5	55	5	220	1	0.1	17
CZRF52C24-HF	ZU	22.80	25.20	5	80	5	220	1	0.1	18
CZRF52C27-HF	ZV	25.65	28.35	5	80	5	250	1	0.1	20
CZRF52C30-HF	ZW	28.50	31.50	5	80	5	250	1	0.1	23
CZRF52C33-HF	ZX	31.35	34.65	5	80	5	250	1	0.1	25
CZRF52C36-HF	ZY	34.20	37.80	5	90	5	250	1	0.1	27
CZRF52C39-HF	ZZ	37.05	40.95	5	90	5	300	1	0.1	29

Company reserves the right to improve product design , functions and reliability without notice.

REV:B

RATING AND CHARACTERISTIC CURVES (CZRF52C2-HF Thru. CZRF52C39-HF)

Fig.1 TEMPERATURE COEFFICIENTS

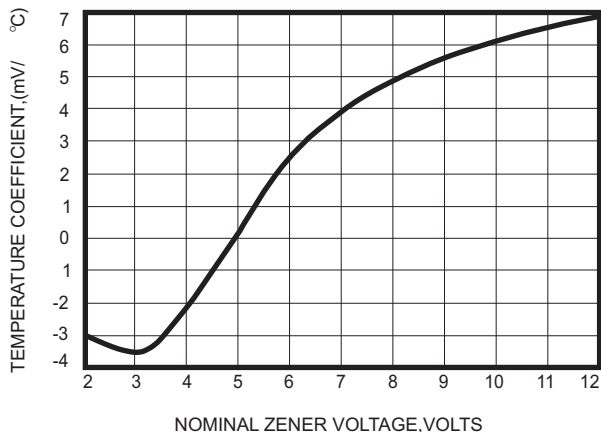

Fig.2 TEMPERATURE COEFFICIENTS

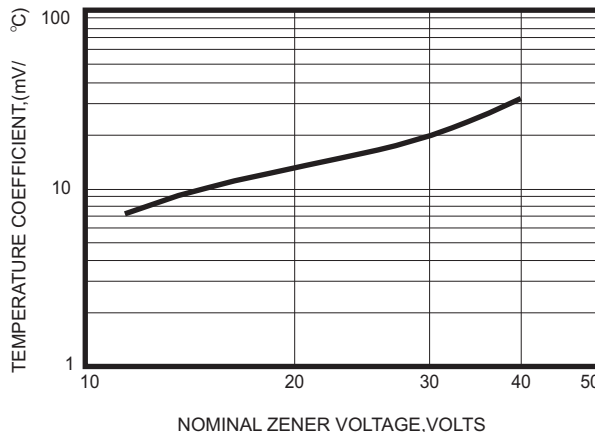

Fig.3 EFFECT OF ZENER VOLTAGE ON ZENER IMPEDANCE

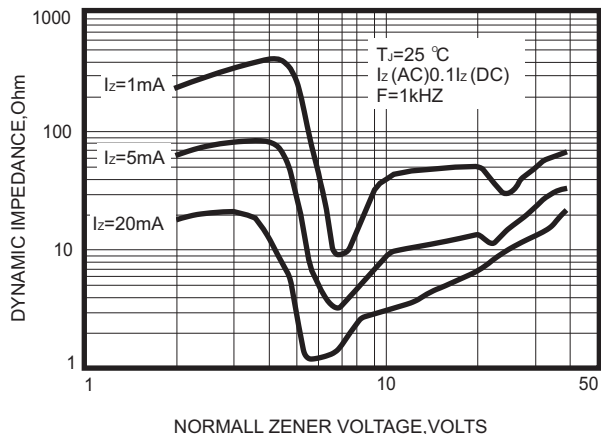

Fig.4 TYPICAL FORWARD VOLTAGE

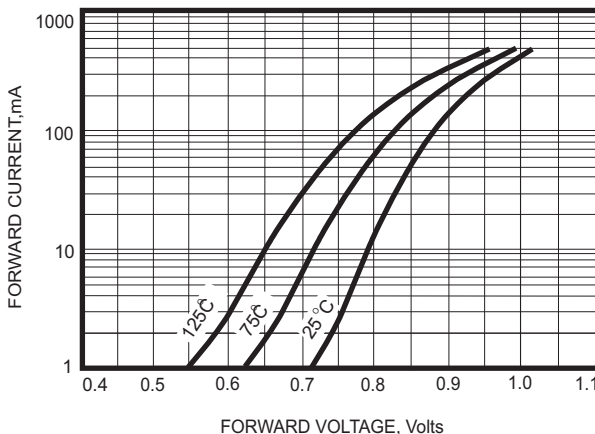

Fig.5 TYPICAL LEAKAGE CURRENT

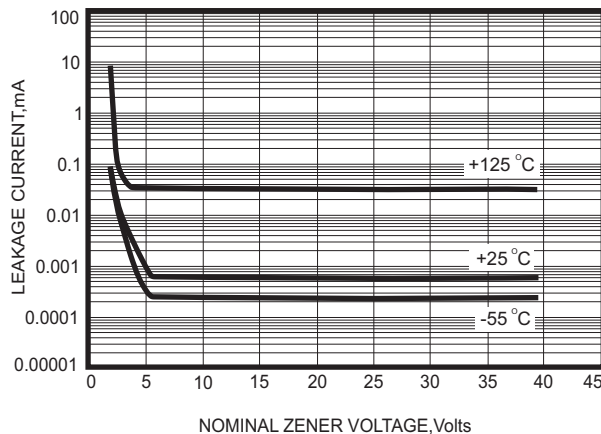
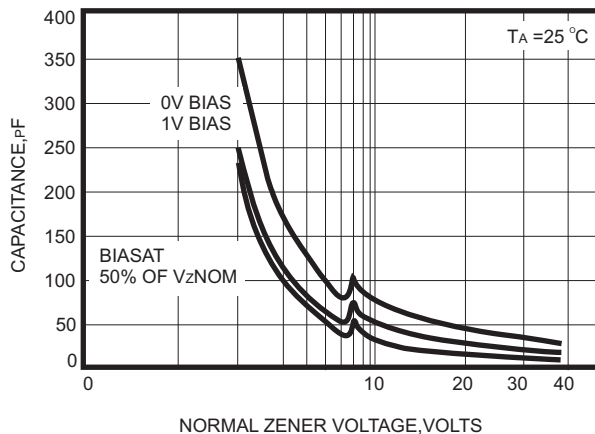

Fig.6 TYPICAL CAPACITANCE



Company reserves the right to improve product design, functions and reliability without notice.

REV:B

RATING AND CHARACTERISTIC CURVES (CZRF52C2-HF Thru. CZRF52C39-HF)

Fig.7 ZENER VOLTAGE VERSUS ZENER CURRENT

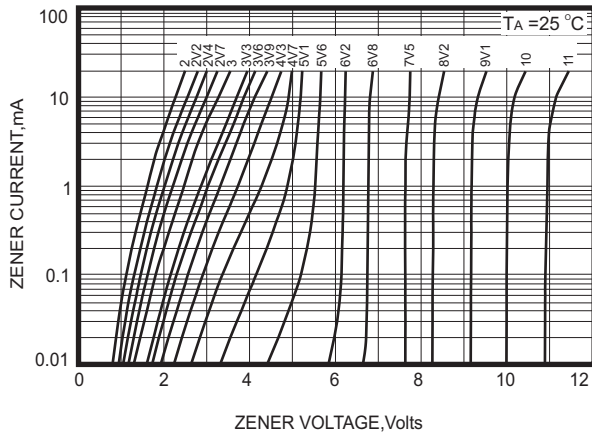

Fig.8 ZENER VOLTAGE VERSUS ZENER CURRENT

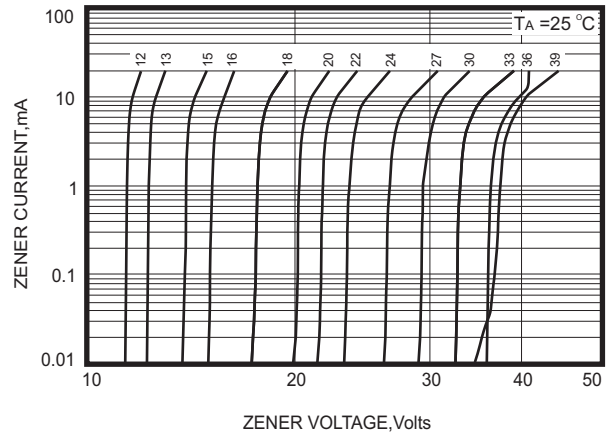
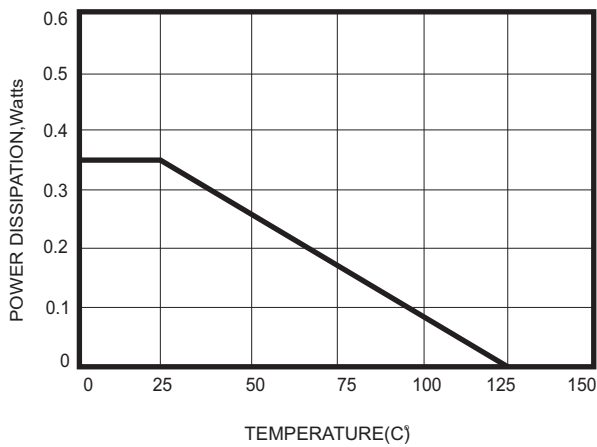
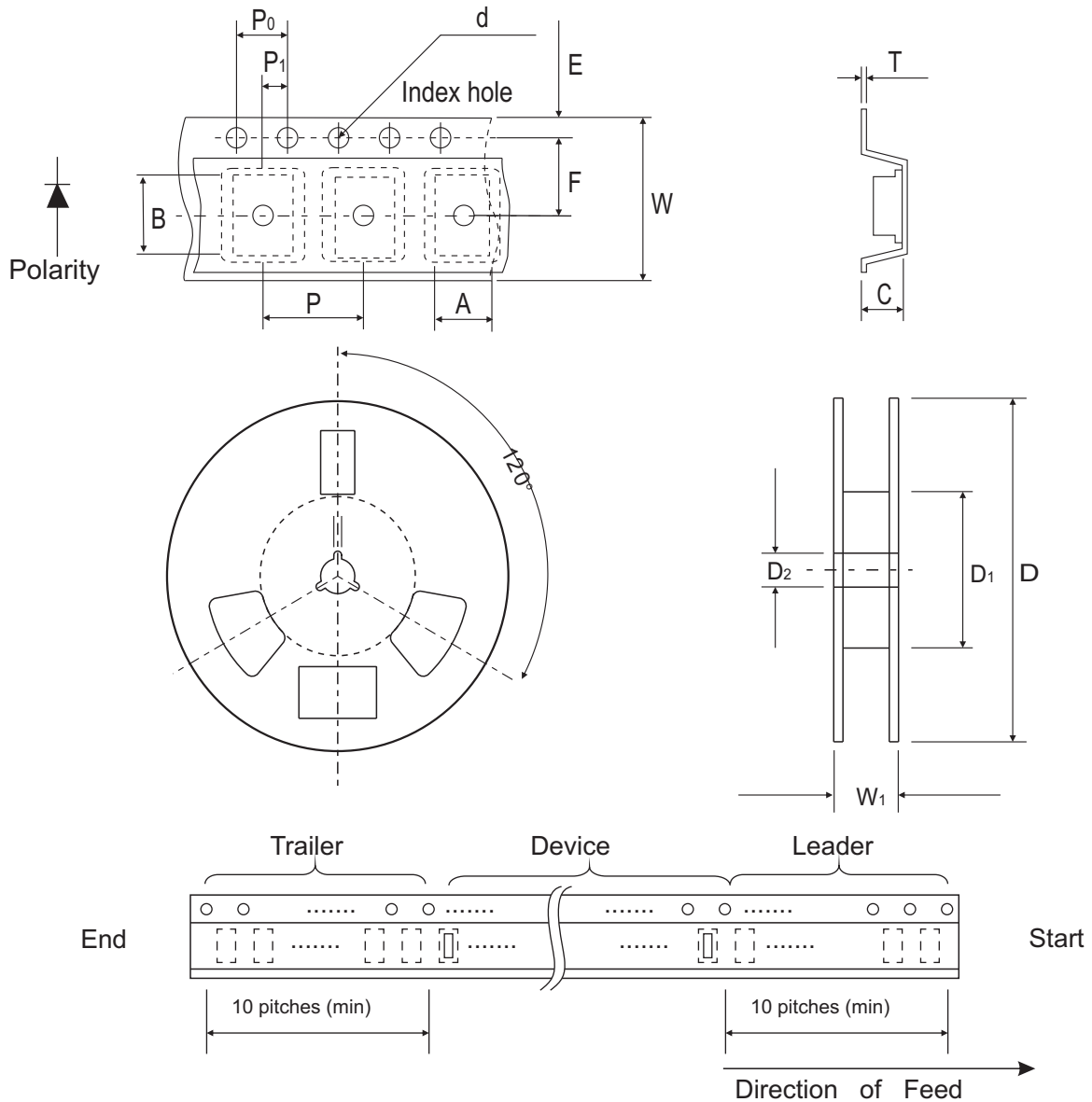

Fig.9 STEADY STATE POWER DERATING



Reel Taping Specification



1005 (SOD-323F)	SYMBOL	A	B	C	d	D	D ₁	D ₂
	(mm)	1.55 ± 0.10	2.65 ± 0.10	1.05 ± 0.10	1.55 ± 0.05	178 ± 1	60.0 MIN.	13.0 ± 0.20
	(inch)	0.061 ± 0.004	0.104 ± 0.004	0.041 ± 0.004	0.061 ± 0.002	7.008 ± 0.04	2.362 MIN.	0.512 ± 0.008

1005 (SOD-323F)	SYMBOL	E	F	P	P ₀	P ₁	T	W	W ₁
	(mm)	1.75 ± 0.10	3.50 ± 0.05	4.00 ± 0.10	4.00 ± 0.10	2.00 ± 0.05	0.23 ± 0.05	8.00 ± 0.20	13.5 MAX.
	(inch)	0.069 ± 0.004	0.138 ± 0.002	0.157 ± 0.004	0.157 ± 0.004	0.079 ± 0.002	0.009 ± 0.002	0.315 ± 0.008	0.531 MAX.

Company reserves the right to improve product design, functions and reliability without notice.

REV:B

Suggested PAD Layout

SIZE	1005/SOD-323F	
	(mm)	(inch)
A	2.10	0.083
B	1.20	0.047
C	1.20	0.047
D	3.30	0.130
E	0.90	0.035

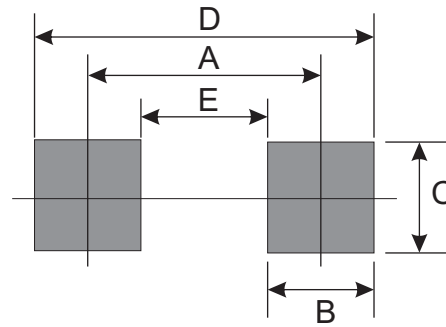

Standard Packaging

Case Type	Qty per Reel	Reel Size
	(Pcs)	(inch)
1005/SOD-323F	4,000	7

Mouser Electronics

Authorized Distributor

Click to View Pricing, Inventory, Delivery & Lifecycle Information:

Comchip Technology:

[CZRF52C5V1](#) [CZRF52C5V6](#) [CZRF52C10-HF](#) [CZRF52C11-HF](#) [CZRF52C12-HF](#) [CZRF52C13-HF](#) [CZRF52C15-HF](#)
[CZRF52C16-HF](#) [CZRF52C18-HF](#) [CZRF52C20-HF](#) [CZRF52C22-HF](#) [CZRF52C24-HF](#) [CZRF52C27-HF](#) [CZRF52C2-](#)
[HF](#) [CZRF52C2V2-HF](#) [CZRF52C2V4-HF](#) [CZRF52C2V7-HF](#) [CZRF52C30-HF](#) [CZRF52C33-HF](#) [CZRF52C36-HF](#)
[CZRF52C39-HF](#) [CZRF52C3-HF](#) [CZRF52C3V3-HF](#) [CZRF52C3V6-HF](#) [CZRF52C3V9-HF](#) [CZRF52C4V3-HF](#)
[CZRF52C4V7-HF](#) [CZRF52C5V1-HF](#) [CZRF52C5V6-HF](#) [CZRF52C6V2-HF](#) [CZRF52C6V8-HF](#) [CZRF52C7V5-HF](#)
[CZRF52C8V2-HF](#) [CZRF52C9V1-HF](#) [CZRF52C2V2](#) [CZRF52C16](#) [CZRF52C4V3](#) [CZRF52C39](#) [CZRF52C30](#)
[CZRF52C22](#) [CZRF52C11](#) [CZRF52C7V5](#) [CZRF52C15](#) [CZRF52C20](#) [CZRF52C2V7](#) [CZRF52C3V6](#) [CZRF52C27](#)
[CZRF52C4V7](#) [CZRF52C33](#) [CZRF52C2V4](#) [CZRF52C9V1](#) [CZRF52C12](#) [CZRF52C13](#) [CZRF52C6V2](#) [CZRF52C8V2](#)
[CZRF52C3V9](#) [CZRF52C2](#) [CZRF52C6V8](#) [CZRF52C10](#) [CZRF52C24](#) [CZRF52C36](#) [CZRF52C18](#) [CZRF52C3V3](#)