

+12V/+15V Step-Up Current-Mode PWM Regulators

ABSOLUTE MAXIMUM RATINGS

Pin Voltages		Operating Temperature Ranges:	
V+, LX	+17V, -0.3V	MAX73_C	0°C to +70°C
VOUT	±25V	MAX73_E	-40°C to +85°C
SS, CC, SHDN	-0.3V to (V+ + 0.3V)	MAX73_MJA	-55°C to +125°C
Peak Switch Current (ILX)	1.5A	Junction Temperatures:	
Reference Current (IvREF)	2.5mA	MAX73_C_/E_	+150°C
Continuous Power Dissipation (TA = +70°C)		MAX73_MJA	+175°C
Plastic DIP (derate 6.9mW/°C above +70°C)	550mW	Storage Temperature Range	-65°C to +160°C
Wide SO (derate 9.5mW/°C above +70°C)	760mW	Lead Temperature (soldering, 10 sec)	+300°C
CERDIP (derate 8.0mW/°C above +70°C)	640mW		

Stresses beyond those listed under "Absolute Maximum Ratings" may cause permanent damage to the device. These are stress ratings only, and functional operation of the devices at these or any conditions beyond those indicated in the operational sections of the specifications is not implied. Exposure to absolute maximum rating conditions for extended periods may affect device reliability.

ELECTRICAL CHARACTERISTICS

(Circuit of Figure 2, V+ = 5V, ILOAD = 0mA, TA = TMIN to TMAX, unless otherwise noted, typical values are at TA = +25°C.)

PARAMETER	CONDITIONS	MAX732			MAX733			UNITS
		MIN	TYP	MAX	MIN	TYP	MAX	
Output Voltage	V+ = 4.5V to 9.3V, 0 < ILOAD < 150mA	MAX732C/E	11.52	12.0	12.48			V
		MAX732M	11.40	12.0	12.60			
	V+ = 6V to 9.3V, 0 < ILOAD < 200mA	MAX732C/E	11.52	12.0	12.48			
		MAX732M	11.40	12.0	12.60			
V+ = 4.5V to 11V, 0 < ILOAD < 100mA	MAX733C/E/M				14.25	15.0	15.75	
	MAX733C/E/M				14.25	15.0	15.75	
Input Voltage Range		4.0		9.3	4.0		11	V
Line Regulation	V+ = 4V to 9.3V		0.20					%V
	V+ = 4V to 11V				0.20			
Load Regulation	ILOAD = 0mA to 100mA		0.0035			0.0035		%/mA
Efficiency	V+ = 5V, ILOAD = 100mA		88			88		%
Supply Current	Includes switch current		1.7	3.0		1.7	3.0	mA
Standby Current	SHDN = 0, Entire circuit		70	100		55	100	µA
	SHDN = 0, Into V+		6			6		
Shutdown Input Threshold	VH (Note 1)	2.0			2.0			V
	VL (Note 1)			0.25			0.25	
Shutdown Input Leakage Current			1.0			1.0		µA
Short-Circuit Current			1.5			1.5		A
Undervoltage Lockout			3.7	4.0		3.7	4.0	V

+12V/+15V Step-Up Current-Mode PWM Regulators

MAX732/MAX733

ELECTRICAL CHARACTERISTICS (continued)

PARAMETER	CONDITIONS	MAX732			MAX733			UNITS
		MIN	TYP	MAX	MIN	TYP	MAX	
LX On Resistance	$I_{LX} = 500\text{mA}$		0.5			0.5		Ω
LX Leakage Current	$V_{DS} = 12\text{V}$		1.0			1.0		μA
Reference Voltage		1.15	1.23	1.30	1.15	1.23	1.30	V
Reference Drift	$T_A = T_{MIN}$ to T_{MAX}		50			50		ppm/ $^{\circ}\text{C}$
Oscillator Frequency		130	170	210	130	170	210	kHz
Compensation Pin Impedance			7500			7500		Ω

Note 1: Shutdown input thresholds not tested, but guaranteed by design.

Typical Operating Characteristics

**SWITCHING WAVEFORMS
CONTINUOUS CONDUCTION**

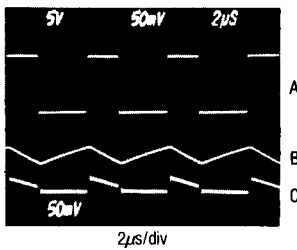

A: Switch Voltage (LX pin), 5V/div, 0V to +12.4V
 B: Inductor Current, 500mA/div
 C: Output Voltage Ripple, 50mV/div
 MAX732, Circuit of Fig. 2, $C_{OUT} = 300\mu\text{F}$, $V_+ = +5\text{V}$, $I_{OUT} = 100\text{mA}$, $T_A = +25^{\circ}\text{C}$

**SWITCHING WAVEFORMS
DISCONTINUOUS CONDUCTION**

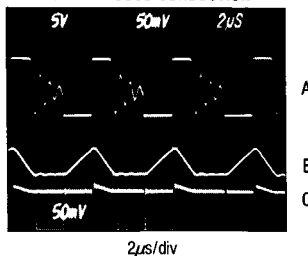

A: Switch Voltage (LX pin), 5V/div, 0V to +12.4V
 B: Inductor Current, 200mA/div
 C: Output Voltage Ripple, 50mV/div
 MAX732, Circuit of Fig. 2, $C_{OUT} = 300\mu\text{F}$, $V_+ = +5\text{V}$, $I_{OUT} = 20\text{mA}$, $T_A = +25^{\circ}\text{C}$

MAX732 LINE TRANSIENT RESPONSE

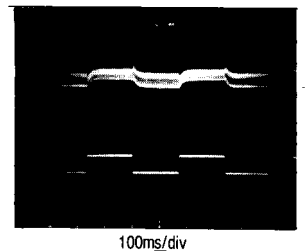

A: V_{OUT} , 50mV/div, DC-Coupled
 B: V_+ , 5V/div, 6.0V to 9.0V
 Circuit of Fig. 2, $I_{OUT} = 200\text{mA}$, $T_A = +25^{\circ}\text{C}$

MAX733 LINE TRANSIENT RESPONSE

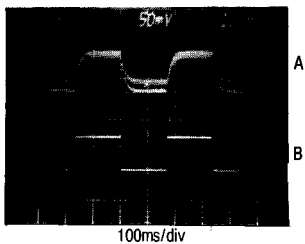

A: V_{OUT} , 50mV/div, DC-Coupled
 B: V_+ , 5V/div, 6.0V to 12.0V
 Circuit of Fig. 2, $I_{OUT} = 125\text{mA}$, $T_A = +25^{\circ}\text{C}$

MAX732 LOAD TRANSIENT RESPONSE

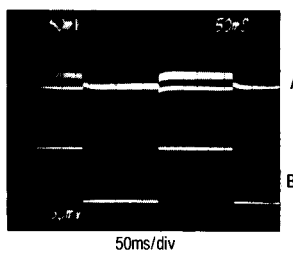

A: V_{OUT} , 50mV/div, DC-Coupled
 B: I_{OUT} , 100mA/div, 10mA to 200mA
 Circuit of Fig. 2, $V_+ = +6\text{V}$, $T_A = +25^{\circ}\text{C}$

MAX733 LOAD TRANSIENT RESPONSE

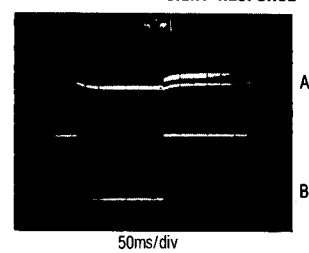

A: V_{OUT} , 50mV/div, DC-Coupled
 B: I_{OUT} , 50mA/div, 10mA to 125mA
 Circuit of Fig. 2, $V_+ = +6\text{V}$, $T_A = +25^{\circ}\text{C}$

+12V/+15V Step-Up Current-Mode PWM Regulators

Typical Operating Characteristics (cont'd)

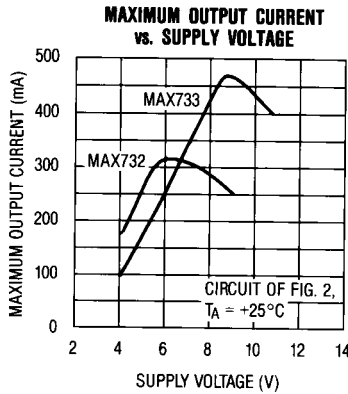
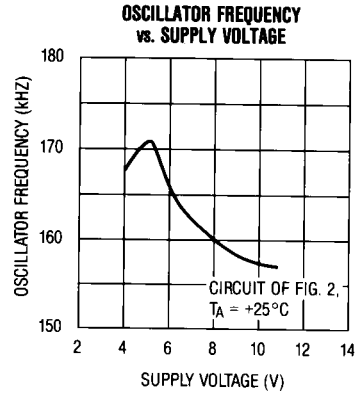
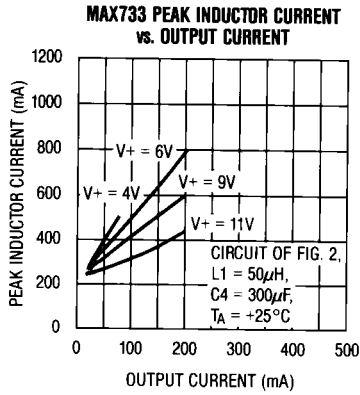
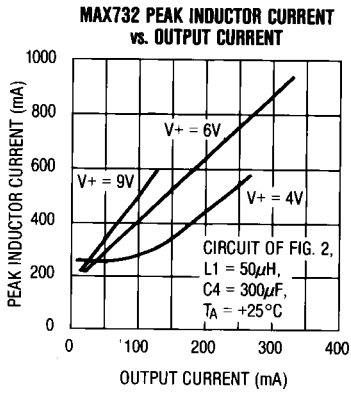
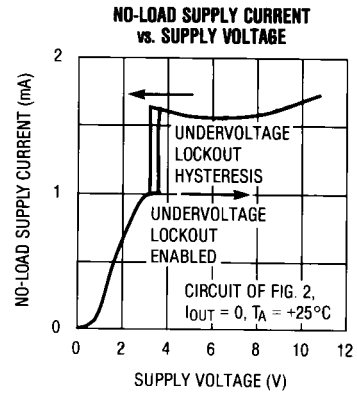
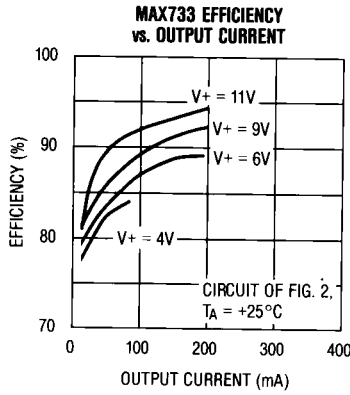
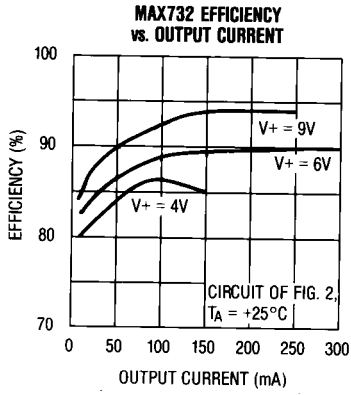

+12V/+15V Step-Up Current-Mode PWM Regulators

Pin Description

MAX732/MAX733

PIN # 8-PIN DIP	PIN # 16-PIN WIDE SO	NAME	FUNCTION
1	2	SHDN	Shutdown—active low. Ground to power-down chip, tie to V+ for normal operation. Output power FET is held off when SHDN is low.
2	3	VREF	Reference Voltage Output (+1.23V). Supplies up to 100 μ A for external loads.
3	5	SS	Soft-Start. Capacitor between SS and GND provides SS and short-circuit protection.
4	6	CC	Compensation Capacitor Input. Externally compensates the outer feedback loop.
5	7	GND	Ground. Ground for control circuitry.
	8, 9	GND (SW)	Switch Ground. Ground of the output power FET. Both pins must be separately tied to ground because they are not internally connected.
6	11, 12, 13	LX	Drain of internal N-channel power MOSFET.
7	14	V _{OUT}	Output-Voltage Sense Input. Provides regulation feedback sensing. Connect to +12V or +15V output.
8	16	V+	Supply Voltage Input. Bypass to GND with 0.1 μ F ceramic and large-value electrolytic capacitors in parallel. The 0.1 μ F capacitor must be as close to the device as possible.
	1, 4, 10, 15	N.C.	No Connect. No internal connections to these pins.

Table 1. Typical Soft-Start Times

MAX732 CIRCUIT CONDITIONS			SOFT-START TIME (ms) vs. C1 (μ F)		
V+ (V)	I _{OUT} (mA)	C4 (μ F)	0.1 μ F	0.47 μ F	1.0 μ F
4.5	0	300	57 ms	115 ms	123 ms
6.0	0	300	40	80	70
9.0	0	300	29	57	44
4.5	100	300	92	348	780
6.0	100	300	59	209	444
9.0	100	300	29	57	60
4.5	200	300	175	713	1690
6.0	200	300	84	340	756
9.0	200	300	28	76	123

MAX733 CIRCUIT CONDITIONS			SOFT-START TIME (ms) vs. C1 (μ F)		
V+ (V)	I _{OUT} (mA)	C4 (μ F)	0.1 μ F	0.47 μ F	1.0 μ F
4.5	0	300	90 ms	208 ms	251 ms
6.0	0	300	64	135	148
9.0	0	300	36	67	53
12.0	0	300	28	49	33
4.5	75	300	157	680	1380
6.0	75	300	103	426	882
9.0	75	300	46	162	305
12.0	75	300	28	49	33
4.5	125	300	235	1124	2260
6.0	125	300	133	596	1255
9.0	125	300	54	231	476
12.0	125	300	30	49	41

Note: Soft-start times are \pm 35% accurate, C1 is the soft-start capacitor, C4 is the output capacitor.

+12V/+15V Step-Up Current-Mode PWM Regulators

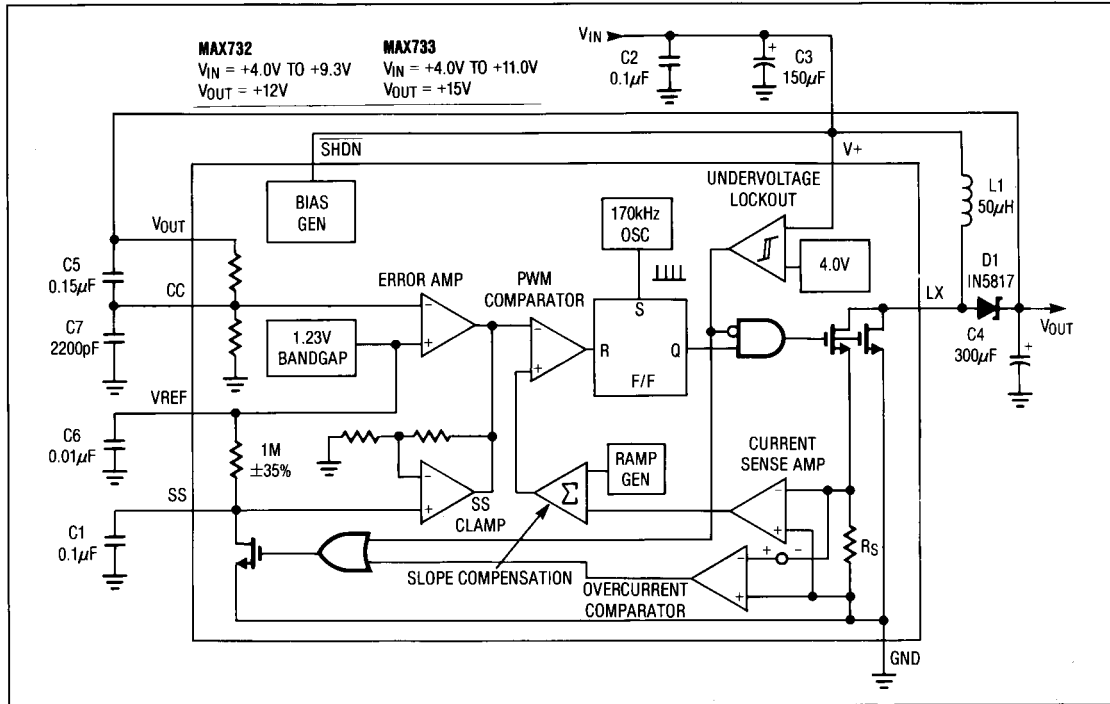

Figure 1. MAX732/MAX733 Detailed Block Diagram with External Components

Operating Principle

The MAX732 +12V switch-mode regulator uses a current-mode pulse-width modulation (PWM) control system coupled with a simple boost regulator topology to convert an unregulated DC voltage ranging from 4.0V to 9.3V to a +12V output. The MAX733 operates likewise, stepping up to +15V from a 4.0V to 11.0V supply. The current-mode PWM architecture provides cycle-by-cycle current limiting and excellent load-transient response characteristics.

Detailed Description

The controller consists of two feedback loops: an inner (current) loop that monitors the switch current via the current-sense resistor (R_s) and amplifier, and an outer (voltage) loop that monitors the output voltage via the error amplifier (Figure 1). The inner loop performs cycle-by-cycle current limiting, truncating the power transistor on-time when the switch current reaches a predetermined threshold. This threshold is determined by the outer loop. For example, a sagging output voltage produces an error signal that raises the threshold, allowing the circuit to store and transfer more energy during each cycle.

Programmable Soft Start

A capacitor connected to the Soft-Start (SS) pin ensures an orderly power-up. The voltage on the charging

capacitor slowly raises the clamp on the error-amplifier output voltage, limiting surge currents at power-up by slowly increasing the cycle-by-cycle current-limit threshold. Soft-start timing is controllable from SS by capacitor choice. A typical value is 0.1µF. Table 1 lists timing characteristics for selected capacitor values and circuit conditions.

The output sags if more than the maximum load current is drawn. The overcurrent comparator trips if the load exceeds approximately 1.5A. An SS cycle is actively initiated when either an undervoltage or overcurrent fault condition triggers an internal transistor to discharge the SS capacitor to ground.

Overcurrent Limiting

When the load current exceeds approximately 1.5A, the output stage is turned off by the inner loop cycle-by-cycle current-limiting action, and the overcurrent comparator signals the control logic to initiate an SS cycle. On each clock cycle, the output FET turns on again and attempts to deliver current until cycle-by-cycle or overcurrent limits are exceeded. Note that the SS capacitor must be at least 0.01µF for overcurrent protection to function properly.

+12V/+15V Step-Up Current-Mode PWM Regulators

MAX732/MAX733

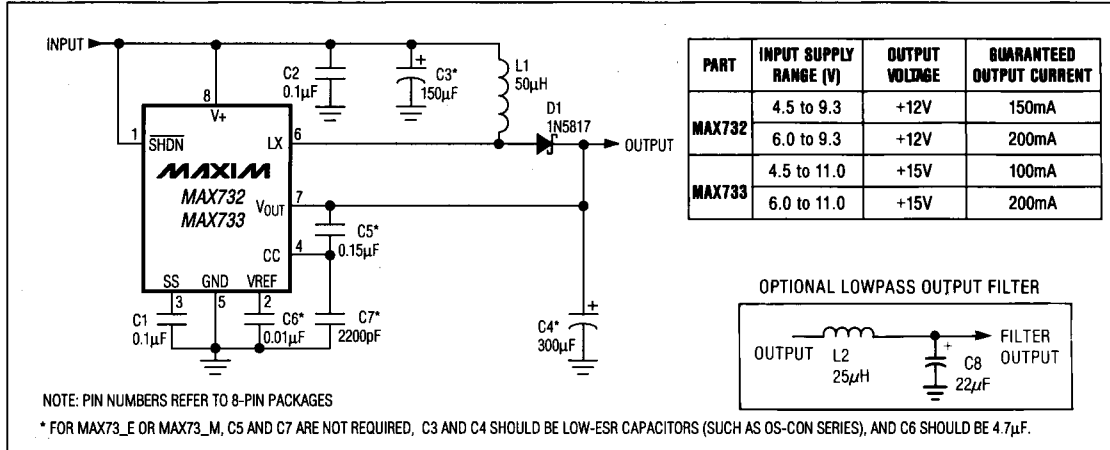

Figure 2. Standard Boost Application Circuit

Undervoltage Lockout

The MAX732/MAX733 monitor the supply voltage at V+ and operate for supply voltages greater than 3.7V (typ), 4.0V guaranteed, with 0.25V hysteresis (see MAX732 Quiescent Supply Current vs. Supply Voltage, *Typical Operating Characteristics*). When an undervoltage condition is detected, control logic turns off the output power FET and discharges the SS capacitor to ground. The control logic holds the output power FET in an off state until the supply voltage rises above the undervoltage threshold, at which time an SS cycle begins.

Shutdown

The MAX732/MAX733 are held in shutdown mode by keeping SHDN at ground. In shutdown, the output power FET is off, but there is still an external path from V+ to the load via the inductor and diode. There is also a path from V+ to GND via the inductor, diode, and internal feedback resistors at the VOUT pin. The internal reference also turns off, which causes the SS capacitor to discharge. Typical device standby current in shutdown mode is 6µA. For normal operation, connect SHDN to V+. An SS cycle is initiated when the MAX732/MAX733 come out of shutdown.

Internal Reference

The +1.23V bandgap reference supplies up to 100µA at VREF. A bypass capacitor from VREF to GND may be required.

Oscillator

The internal oscillator typically operates at 170kHz. Temperature stability over the military temperature range is about 0.06%/°C.

Applications Information

Standard +12V or +15V Output Step-Up Converter Application in Continuous-Conduction Mode

Figure 2 shows the standard +12V or +15V step-up application circuit for continuous-conduction mode operation. This circuit will operate over its entire line, load, and temperature ranges using the single set of component values shown. All components shown are suitable for both the MAX732 and the MAX733.

The MAX732 delivers a guaranteed 150mA for 4.5V to 9.3V supply voltages, and a guaranteed 200mA for supplies from 6.0V to 9.3V. The MAX733 is guaranteed to deliver 100mA for inputs ranging from 4.5V to 11.0V and 125mA for inputs from 6.0V to 12.0V. Both devices regulate at supply voltages down to 4.0V (the upper limit of undervoltage lockout), but some reduction of the maximum output current will occur.

Continuous-conduction mode operation gives a cleaner output than discontinuous operation. Peak-to-peak ripple amplitude is minimized and ripple frequency is fixed at the oscillator frequency. Both conditions make the output noise easy to filter. However, continuous-conduction mode operation requires additional compensation and bypass capacitors, as shown in Figure 2.

For extended and military temperature range applications, C3 and C5 (in Figure 2) should be low-ESR capacitors. When OS-CON capacitors are used, no compensation is necessary, so C5 and C7 are not required. However, the reference bypass capacitor C6 should be at least 4.7µF. Figure 2 shows an example using through-hole components. Figure 3 shows an example of a power supply designed with surface-mount components.

+12V/+15V Step-Up Current-Mode PWM Regulators

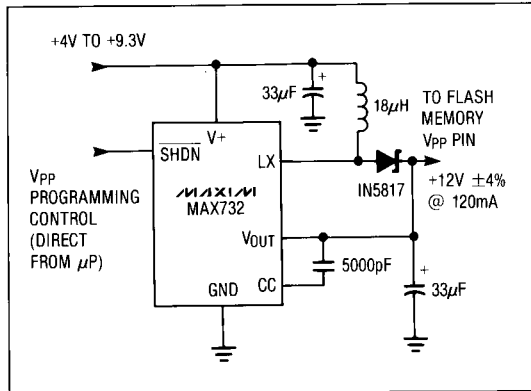

Figure 3. Flash Memory Programmer

V+ BYPASS REQUIREMENTS

MAX733 applications should place capacitor C2 (Figure 2) to within 1/2 inch from the V+ and GND pins of the IC. This capacitor helps snub high voltages created by large load transients.

+12V Flash Memory Programming Power Supply

The circuit of Figure 3 is a simple +12V ±4%, 120mA flash memory programmer. The small 18μH inductor forces the circuit to operate in discontinuous-conduction mode, which allows for smaller input and output filter capacitors and the removal of several bypass and compensation capacitors relative to the standard application. It also makes the circuit less sensitive to PC layout errors. Programming is controlled by a direct microprocessor input to the SHDN pin of the MAX732. When SHDN is forced high, the output voltage, which is connected to the V_{PP} input of the flash memory, rises to +12V and programs the flash memory. When SHDN goes low, the output voltage drops to approximately a diode drop below V_{IN}. The voltage at the V_{PP} pin has to be kept below 6.5V to avoid inadvertent programming.

For a +5V input, efficiency is 88%, quiescent current for this circuit is 1.7mA, circuit shutdown current is 70μA, and shutdown current into the V+ pin is 6μA. See Application Note 4.2.

2-Cell to +12V Battery-Powered Flash Memory Programming Supply

The circuit of Figure 4 allows for +12V step-up operation with battery supplies as low as 1.8V. The MAX732 supply voltage (V+) and programming control pin (SHDN) operate from the +5V logic supply, while the voltage across the inductor is supplied directly from the battery.

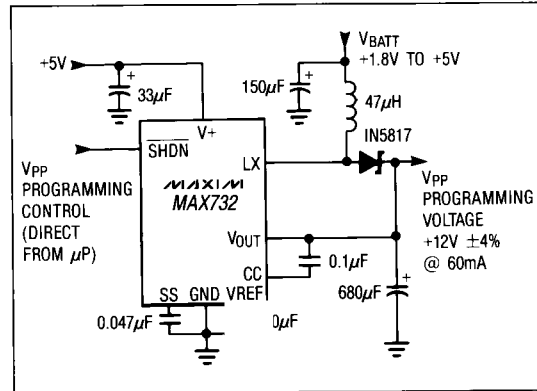

Figure 4. 2-Cell to +12V Battery-Powered Flash Memory Programmer

This application is targeted for 60mA operation. It is not possible to achieve output currents greater than 80mA with V_{BATT} below 2.0V because of the high peak currents required.

Inductor Selection

The MAX732/MAX733 require no inductor design. They are tested in-circuit, and are guaranteed to deliver the power specified in the *Electrical Characteristics* with high efficiency using a single 50μH inductor. A 47μH inductor can also be used. The 50μH inductor's incremental saturation current rating should be greater than 500mA for 200mA load operation. For lower power applications, smaller inductor values may be used. Table 2 shows recommended inductor types and suppliers for various applications. The listed surface-mount inductors' efficiencies are nearly equivalent to those of the larger-sized, through-hole inductors.

Output Filter Capacitor Selection

The primary criterion for selecting the output filter capacitor is low equivalent series resistance (ESR). The product of the inductor current variation and the ESR of the output capacitor determines the amplitude of the high-frequency ripple seen on the output voltage. The ESR of the capacitor should be less than 0.25Ω to keep the output ripple less than 50mV_{p-p} over the entire current range (using a 50μH inductor). In addition, the ESR of the output filter capacitor should be minimized to maintain AC stability. Refer to Table 2 for suggested capacitor suppliers.

In the standard application of Figure 2, the output capacitor value should be at least 300μF in order to maintain stability at full loads. 150μF capacitors (MAXC001) are available from Maxim in production quantities. Two of these capacitors can be connected in

+12V/+15V Step-Up Current-Mode PWM Regulators

MAX732/MAX733

Table 2. Component Suppliers

PRODUCTION METHOD	INDUCTORS	CAPACITORS
Surface Mount	Sumida (847) 956-0666 CD54-470 (47 μ H) CD54-180 (18 μ H) for discontinuous mode Coiltronics (561) 241-7876 CTX 100-series	Matsuo (714) 969-2491 267-series
Miniature Through-Hole	Sumida (847) 956-0666 RCH654-470	Sanyo (619) 661-6835 OS-CON-series Low ESR Organic Semiconductor
Low-Cost Through-Hole	Renco (516) 586-5566 RL 1284-47	Maxim MAXC001 150 μ F, Low ESR Electrolytic Nichicon (847) 843-7500 PL-series Low ESR Electrolytics United Chemicon (714) 255-9500 LXF-series

parallel. Lighter loads require proportionately lesser capacitor values. For operation below -10°C, OS-CON series capacitors are suitable when using through-hole components.

Other Components

The catch diode should be a Schottky or high-speed silicon rectifier with a current rating of at least 500mA for full-load (200mA) operation. The 1N5817 is a good choice. The two compensation capacitor (CC) values

at the CC input are critical because they have been selected to provide the best transient responses.

Output Ripple Filtering

An optional lowpass pi-filter (Figure 2) can be added to the output to reduce output ripple to about 5mV_{p-p}. The cutoff frequency of the filter shown is 21kHz. Since the filter inductor is in series with the circuit output, its resistance should be minimized to avoid excessive voltage drop.

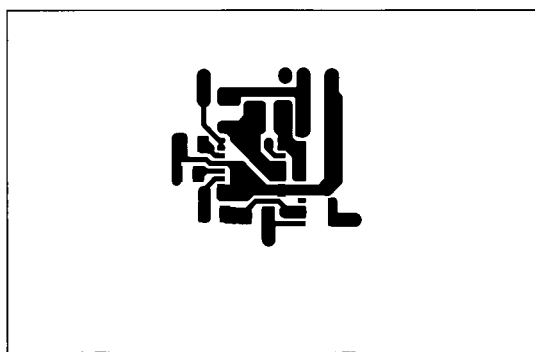

Figure 5. Surface-Mount PC Layout for Standard Step-Up Application (1x Scale, Top-Side Trace View)

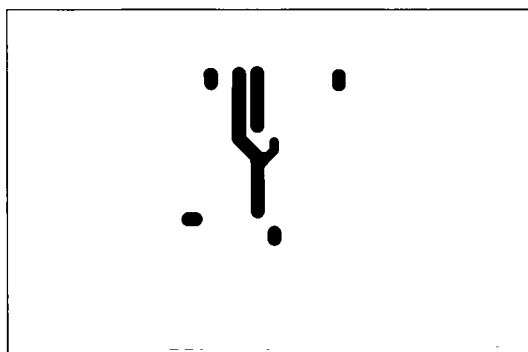

Figure 6. Surface-Mount PC Layout for Standard Step-Up Application (1x Scale, Bottom-Side Trace View)

+12V/+15V Step-Up Current-Mode PWM Regulators

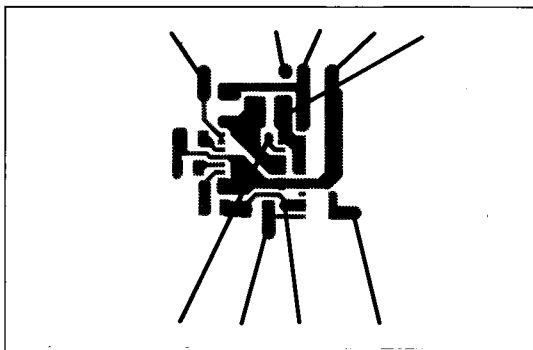

Figure 7. Surface-Mount Drilling Guide for Standard Step-Up Application. All Holes are 0.031" in diameter. (1x Scale, Top-Side Trace View)

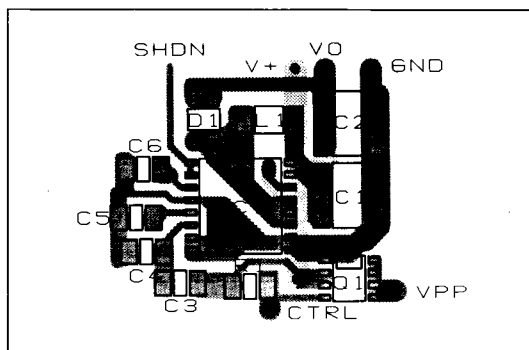

Figure 8. Surface-Mount Component Placement Diagram for Standard Step-Up Application. Component Labels Refer to Figure 9

Printed Circuit Layouts

A good layout is essential to clean, stable operation. The surface-mount layout and component placement diagrams in Figures 5-8 have been successfully tested over a wide range of operating conditions. The surface-mount layout shown is configured for the Sumida and Matsuo surface-mount components listed in Table 2. Note that the input bypass capacitors must be positioned as close to the V_{OUT} and GND pins as possible. The traces connecting the ground to the input and output filter capacitors and the MAX732/MAX733 GND pin must be short to reduce stray inductance.

MAX732 Evaluation Board

An assembled surface-mount printed circuit board is available for the MAX732. Intended for prototyping and performance evaluation, this board is a +12V switched power supply capable of delivering 120mA. The evaluation board circuit is configured as the flash memory programmer shown in Figure 9, and contains all components, including a miniature surface-mount inductor and tantalum filter capacitors on a printed circuit layout similar to Figures 5-8. Also included on the board is a P-channel MOSFET switch for applications that require total turn-off of the MAX732 output. The evaluation board can be ordered as part number "MAX732EVKIT." For more information about the MAX732 evaluation board refer to AN-4.1, "MAX732 EV Surface-Mount Evaluation Board and Flash EEPROM Power Supply Application Notes."

+12V/+15V Step-Up Current-Mode PWM Regulators

MAX732/MAX733

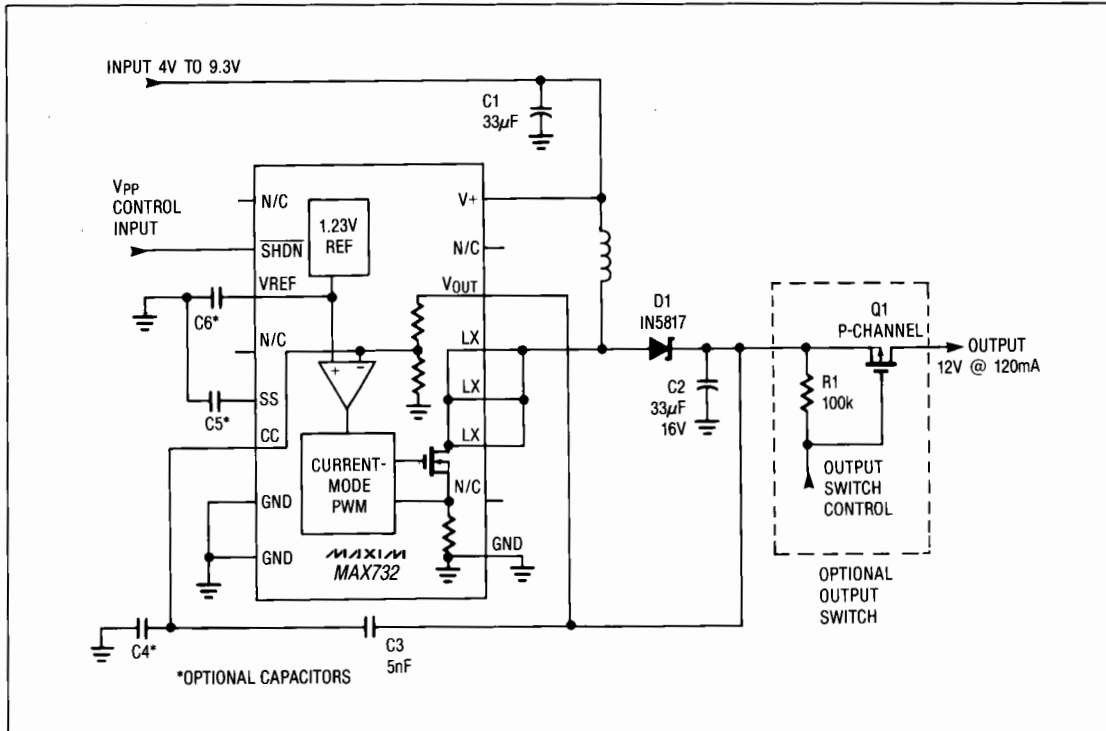
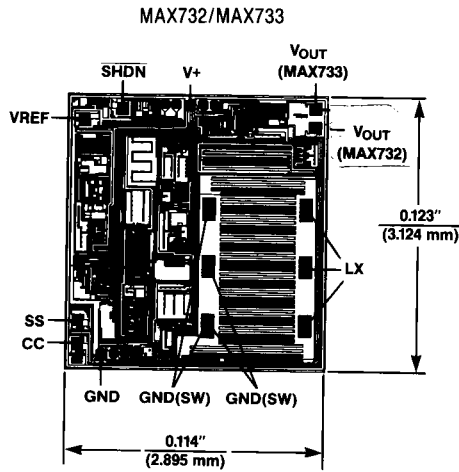

Figure 9. Circuit Schematic for Surface-Mount Evaluation Board

+12V/+15V Step-Up Current-Mode PWM Regulators

Chip Topography

MAX732/MAX733



NOTE: CONNECT SUBSTRATE TO V+
TRANSISTOR COUNT: 226

Maxim cannot assume responsibility for use of any circuitry other than circuitry entirely embodied in a Maxim product. No circuit patent licenses are implied. Maxim reserves the right to change the circuitry and specifications without notice at any time.

12 **Maxim Integrated Products, 120 San Gabriel Drive, Sunnyvale, CA 94086 (408) 737-7600**

© 1996 Maxim Integrated Products

Printed USA

MAXIM is a registered trademark of Maxim Integrated Products.

Mouser Electronics

Authorized Distributor

Click to View Pricing, Inventory, Delivery & Lifecycle Information:

Maxim Integrated:

[MAX732CWE+](#) [MAX732MJA/883B](#) [MAX732CWE+T](#) [MAX732EWE+](#) [MAX732EWE](#) [MAX732EWE+T](#) [MAX732CWE-](#)
[T](#) [MAX732EWE-T](#) [MAX732CPA](#) [MAX732CWE](#) [MAX732EPA+](#)