

## TABLE OF CONTENTS

Features .....	1	Fault Alert.....	35
Applications.....	1	Voltage Output Short Circuit Protection .....	35
General Description .....	1	Voltage Output Overrange .....	35
Companion Products .....	1	Voltage Output Force-Sense .....	35
Revision History .....	3	Asynchronous Clear (CLEAR) .....	35
Functional Block Diagram .....	4	Internal Reference .....	35
Specifications.....	5	External Current Setting Resistor .....	35
AC Performance Characteristics .....	10	Digital Power Supply.....	36
Timing Characteristics .....	10	External Boost Function.....	36
Absolute Maximum Ratings.....	13	External Compensation Capacitor.....	36
ESD Caution.....	13	HART Communication.....	36
Pin Configurations and Function Descriptions .....	14	Digital Slew Rate Control.....	36
Typical Performance Characteristics .....	16	I <sub>OUT</sub> Filtering Capacitors (LFCSP Package).....	37
General.....	16	Applications Information .....	39
Voltage Output.....	18	Voltage and Current Output Ranges on the Same Terminal	39
Current Output.....	23	Driving Inductive Loads.....	39
Terminology .....	27	Transient Voltage Protection .....	39
Theory of Operation .....	29	Galvanically Isolated Interface .....	39
Architecture.....	29	Microprocessor Interfacing.....	39
Serial Interface .....	30	Layout Guidelines.....	40
Power-On State .....	31	Thermal and Supply Considerations .....	40
Data Register .....	33	Industrial Analog Output Module.....	41
Control Register.....	33	Industrial HART Capable Analog Output Application .....	41
Reset Register.....	34	Outline Dimensions .....	43
Status Register .....	34	Ordering Guide .....	44
AD5412/AD5422 Features .....	35		

**REVISION HISTORY****10/2017—Rev. N to Rev. O**

Changed CP-40-10 to CP-40-1 .....	Throughout
Updated Outline Dimensions.....	43
Changes to Ordering Guide.....	44

**3/2017—Rev. M to Rev. N**

Changed CP-40-9 to CP-40-10.....	Throughout
Changes to Table 6 .....	13
Changes to Figure 85 .....	43
Updated Outline Dimensions.....	43
Changes to Ordering Guide.....	44

**7/2016—Rev. L to Rev. M**

Changed $-40^{\circ}\text{C}$ to $+85^{\circ}\text{C}$ to $-40^{\circ}\text{C}$ to $+105^{\circ}\text{C}$ and CP-40-1 to CP-40-9 .....	Throughout
Changes to Table 2 .....	5
Added Table 3; Renumbered Sequentially .....	9
Changes to Figure 6.....	14
Changes to Thermal and Supply Conditions Section .....	40
Updated Outline Dimensions.....	43
Changes to Ordering Guide.....	44

**7/2015—Rev. K to Rev. L**

Change to $I_{\text{OUT}}$ to GND Parameter, Table 5 .....	11
Change to Voltage and Current Output Ranges on the Same Terminal Section .....	37

**3/2015—Rev. J to Rev. K**

Changes to Table 4 .....	9
Changes to Table 6 .....	13
Changes to Power-On State Section .....	29

**10/2014—Rev. I to Rev. J**

Changes to Power-On State Section .....	29
Changes to Table 25 .....	39

**10/2013—Rev. H to Rev. I**

Added Figure 34 and Figure 35; Renumbered Sequentially.....	18
Changes to Figure 78 .....	37
Changes to Industrial Analog Output Module Section .....	39
Changes to Industrial HART Capable Analog Output Application Section.....	39

**6/2013—Rev. G to Rev. H**

Change to REFOUT Pin, Table 6 .....	12
Changes to Voltage and Current Output Ranges on the Same Terminal Section and Figure 75 .....	36

**3/2013—Rev. F to Rev. G**

Changed TSSOP_EP $\theta_{\text{JA}}$ from $42^{\circ}\text{C}/\text{W}$ to $35^{\circ}\text{C}/\text{W}$ , Changed LFCSP $\theta_{\text{JA}}$ from $28^{\circ}\text{C}/\text{W}$ to $33^{\circ}\text{C}/\text{W}$ , and Added Endnote 2.....	11
Added Figure 67 .....	30
Changes to REXT Description; Table 15.....	31

Changes to Table 21 .....	33
Changes to Thermal and Supply Considerations Section .....	38
Changes to Table 25 .....	39

**7/2012—Rev. E to Rev. F**

Updated Outline Dimensions.....	40
Changes to Ordering Guide.....	40

**5/2012—Rev. D to Rev. E**

Reorganized Layout .....	Universal
Changes to Product Title.....	1
Changes to Features Section, Applications Section, and General Description Section; Added Companion Products Section.....	1
Changes to Figure 1 .....	3
Change to Offset Error Temperature Coefficient (TC) Parameter, Table 1 .....	4
Changes to Table 6 .....	12
Changes to Power-On State Section .....	29
Added HART Communication Section and Figure 68, Renumbered Sequentially .....	33
Added Voltage and Current Output Ranges on the Same Terminal Section and Figure 74 .....	36
Added Industrial HART Capable Analog Output Application Section .....	38
Added Figure 79 .....	39

**11/2011—Rev. C to Rev. D**

Changes to Table 15 .....	29
---------------------------	----

**3/2010—Rev. B to Rev. C**

Changes to AVSS to GND Parameter in Table 5.....	10
--	----

**2/2010—Rev. A to Rev. B**

Changes to Thermal and Supply Considerations Section and Table 25.....	36
--	----

**8/2009—Rev. 0 to Rev. A**

Changes to Table 2 .....	4
Changes to Table 3 .....	7
Changes to Introduction to Table 4.....	8
Changes to Introduction to Table 5 and to Table 5 .....	10
Changes to Pin Configurations and Function Descriptions Section, Added Figure 6, Renumbered Subsequent Figures .....	11
Changes to Theory of Operation Section .....	26
Changes to Architecture Section.....	26
Changes to AD5412/AD5422 Features Section .....	31
Added $I_{\text{OUT}}$ Filtering Capacitors (LFCSP Package) Section, Including Figure 69 to Figure 72 and Table 24.....	33
Changes to Thermal and Supply Considerations Section .....	36
Updated Outline Dimensions.....	38
Changes to Ordering Guide.....	39

**5/2009—Revision 0: Initial Version**

FUNCTIONAL BLOCK DIAGRAM

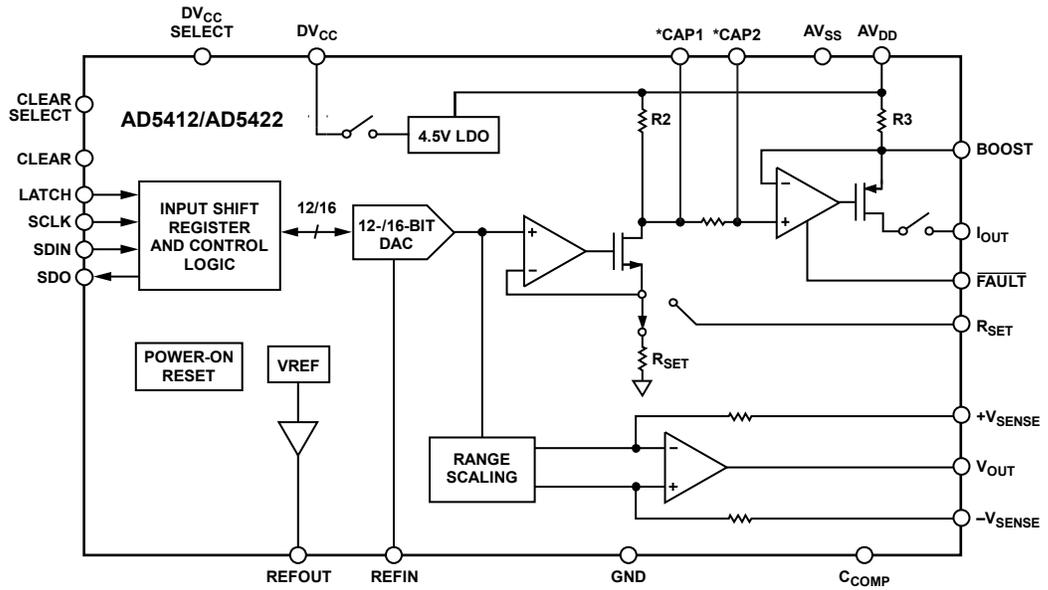

\*PINS ONLY ON LFCSP OPTION.

Figure 1.

## SPECIFICATIONS

$AV_{DD} = 10.8\text{ V to }26.4\text{ V}$ ,  $AV_{SS} = -26.4\text{ V to }-3\text{ V/0 V}$ ,  $AV_{DD} + |AV_{SS}| < 52.8\text{ V}$ ,  $GND = 0\text{ V}$ ,  $REFIN = 5\text{ V external}$ ;  $DV_{CC} = 2.7\text{ V to }5.5\text{ V}$ .  
 $V_{OUT}$ :  $R_{LOAD} = 1\text{ k}\Omega$ ,  $C_L = 200\text{ pF}$ ,  $I_{OUT}: R_{LOAD} = 350\ \Omega$ ; all specifications  $T_{MIN}$  to  $T_{MAX}$ , unless otherwise noted.

**Table 2.**

Parameter <sup>1</sup>	Min	Typ	Max	Unit	Test Conditions/Comments
<b>VOLTAGE OUTPUT</b>					
Output Voltage Ranges	0		5	V	
	0		10	V	
	-5		+5	V	
	-10		+10	V	
Accuracy					Output unloaded
Resolution	16			Bits	<a href="#">AD5422</a>
	12			Bits	<a href="#">AD5412</a>
Total Unadjusted Error (TUE)					
B Version	-0.1		+0.1	% FSR	
	-0.05	$\pm 0.01$	+0.05	% FSR	$T_A = 25^\circ\text{C}$
A Version	-0.3		+0.3	% FSR	$T_A = -40^\circ\text{C to }+85^\circ\text{C}$
	-0.1	$\pm 0.05$	+0.1	% FSR	$T_A = 25^\circ\text{C}$
Relative Accuracy (INL) <sup>2</sup>	-0.008		+0.008	% FSR	<a href="#">AD5422</a>
	-0.032		+0.032	% FSR	<a href="#">AD5412</a>
Differential Nonlinearity (DNL)	-1		+1	LSB	$T_A = -40^\circ\text{C to }+85^\circ\text{C}$ , guaranteed monotonic
	-1		+1.3	LSB	Guaranteed monotonic
Bipolar Zero Error	-6		+6	mV	$T_A = -40^\circ\text{C to }+85^\circ\text{C}$ , bipolar output range
	-9		+9	mV	Bipolar output range
	-1.5	$\pm 0.2$	+1.5	mV	$T_A = 25^\circ\text{C}$ , bipolar output range
Bipolar Zero Error Temperature Coefficient (TC) <sup>3</sup>		$\pm 3$		ppm FSR/ $^\circ\text{C}$	Bipolar output range
Zero-Scale Error	-5		+5	mV	$T_A = -40^\circ\text{C to }+85^\circ\text{C}$
	-8		+8	mV	
	-3.5	$\pm 0.3$	+3.5	mV	$T_A = 25^\circ\text{C}$
Zero-Scale Error TC <sup>3</sup>		$\pm 2$		ppm FSR/ $^\circ\text{C}$	
Offset Error	-4		+4	mV	$T_A = -40^\circ\text{C to }+85^\circ\text{C}$ , unipolar output range
	-6		+6	mV	Unipolar output range
	-1.5	$\pm 0.2$	+1.5	mV	$T_A = 25^\circ\text{C}$ , unipolar output range
Offset Error TC <sup>3</sup>		$\pm 2$		ppm FSR/ $^\circ\text{C}$	Unipolar output range
Gain Error	-0.07		+0.07	% FSR	
	-0.05	$\pm 0.004$	+0.05	% FSR	$T_A = 25^\circ\text{C}$
Gain Error TC <sup>3</sup>		$\pm 1$		ppm FSR/ $^\circ\text{C}$	$T_A = -40^\circ\text{C to }+85^\circ\text{C}$
		$\pm 3$		ppm FSR/ $^\circ\text{C}$	
Full-Scale Error	-0.07		+0.07	% FSR	
	-0.05	$\pm 0.001$	+0.05	% FSR	$T_A = 25^\circ\text{C}$
Full-Scale Error TC <sup>3</sup>		$\pm 1$		ppm FSR/ $^\circ\text{C}$	$T_A = -40^\circ\text{C to }+85^\circ\text{C}$
		$\pm 2$		ppm FSR/ $^\circ\text{C}$	

Parameter <sup>1</sup>	Min	Typ	Max	Unit	Test Conditions/Comments
<b>OUTPUT CHARACTERISTICS<sup>3</sup></b>					
Headroom		0.5	0.8	V	Output unloaded
Output Voltage Drift vs. Time		90		ppm FSR	Drift after 1000 hours, T <sub>A</sub> = 125°C
Short-Circuit Current		20		mA	
Load	1			kΩ	
Capacitive Load Stability					T <sub>A</sub> = 25°C
R <sub>LOAD</sub> = ∞			20	nF	
R <sub>LOAD</sub> = 1 kΩ			5	nF	
R <sub>LOAD</sub> = ∞			1	μF	External compensation capacitor of 4 nF connected
DC Output Impedance		0.3		Ω	
Power-On Time		10		μs	
DC PSRR		90	130	μV/V	
		3	12	μV/V	Output unloaded
<b>CURRENT OUTPUT</b>					
Output Current Ranges	0		24	mA	
	0		20	mA	
	4		20	mA	
Accuracy (Internal R <sub>SET</sub> )					
Resolution	16			Bits	<a href="#">AD5422</a>
	12			Bits	<a href="#">AD5412</a>
TUE					
B Version	-0.3		+0.3	% FSR	
	-0.13	±0.08	+0.13	% FSR	T <sub>A</sub> = 25°C
A Version	-0.5		+0.5	% FSR	T <sub>A</sub> = -40°C to +85°C
	-0.3	±0.15	+0.3	% FSR	T <sub>A</sub> = 25°C
INL <sup>4</sup>	-0.024		+0.024	% FSR	<a href="#">AD5422</a>
	-0.032		+0.032	% FSR	<a href="#">AD5412</a>
DNL	-1		+1	LSB	T <sub>A</sub> = -40°C to +85°C, guaranteed monotonic
	-1		+1.3	LSB	Guaranteed monotonic
Offset Error	-0.27		+0.27	% FSR	T <sub>A</sub> = -40°C to +85°C
	-0.40		+0.40	% FSR	
	-0.12	±0.08	+0.12	% FSR	T <sub>A</sub> = 25°C
Offset Error TC <sup>3</sup>		±16		ppm FSR/°C	T <sub>A</sub> = -40°C to +85°C
		±28		ppm FSR/°C	
Gain Error	-0.18		+0.18	% FSR	T <sub>A</sub> = -40°C to +85°C, <a href="#">AD5422</a>
	-0.20		+0.20	% FSR	<a href="#">AD5422</a>
	-0.03	±0.006	+0.03	% FSR	<a href="#">AD5422</a> , T <sub>A</sub> = 25°C
	-0.22		+0.22	% FSR	T <sub>A</sub> = -40°C to +85°C, <a href="#">AD5412</a>
	-0.24		+0.24	% FSR	<a href="#">AD5412</a>
	-0.06	±0.006	+0.06	% FSR	<a href="#">AD5412</a> , T <sub>A</sub> = 25°C
Gain TC <sup>3</sup>		±10		ppm FSR/°C	T <sub>A</sub> = -40°C to +85°C
		±21		ppm FSR/°C	
Full-Scale Error	-0.2		+0.2	% FSR	T <sub>A</sub> = -40°C to +85°C
	-0.40		+0.40	% FSR	
	-0.1	±0.08	+0.1	% FSR	T <sub>A</sub> = 25°C
Full-Scale TC <sup>3</sup>		±6		ppm FSR/°C	T <sub>A</sub> = -40°C to +85°C
		±13		ppm FSR/°C	

Parameter <sup>1</sup>	Min	Typ	Max	Unit	Test Conditions/Comments
Accuracy (External R <sub>SET</sub> )					
Resolution	16			Bits	<a href="#">AD5422</a>
TUE	12			Bits	<a href="#">AD5412</a>
B Version	-0.15		+0.15	% FSR	T <sub>A</sub> = 25°C
A Version	-0.06	±0.01	+0.06	% FSR	T <sub>A</sub> = -40°C to +85°C
INL <sup>4</sup>	-0.3	±0.02	+0.1	% FSR	T <sub>A</sub> = 25°C
DNL	-0.012		+0.012	% FSR	<a href="#">AD5422</a>
Offset Error	-0.032		+0.032	% FSR	<a href="#">AD5412</a>
Offset Error TC <sup>3</sup>	-1		+1	LSB	T <sub>A</sub> = -40°C to +85°C, guaranteed monotonic
Gain Error	-1		+1.3	LSB	Guaranteed monotonic
Gain TC <sup>3</sup>	-0.1		+0.1	% FSR	T <sub>A</sub> = -40°C to +85°C
Full-Scale Error	-0.12		+0.12	% FSR	
Full-Scale Error TC <sup>3</sup>	-0.03	±0.006	+0.03	ppm FSR/°C	T <sub>A</sub> = 25°C
		±3		ppm FSR/°C	T <sub>A</sub> = -40°C to +85°C
		±5			
	-0.08		+0.08	% FSR	T <sub>A</sub> = -40°C to +85°C
	-0.15		+0.15	% FSR	
	-0.05	±0.003	+0.05	% FSR	T <sub>A</sub> = 25°C
		±4		ppm FSR/°C	
	-0.15		+0.15	% FSR	
	-0.06	±0.01	+0.06	% FSR	T <sub>A</sub> = 25°C
		±7		ppm FSR/°C	T <sub>A</sub> = -40°C to +85°C
		±9		ppm FSR/°C	
OUTPUT CHARACTERISTICS <sup>3</sup>					
Current Loop Compliance Voltage	0		AV <sub>DD</sub> - 2.5	V	
Output Current Drift vs. Time		50		ppm FSR	Drift after 1000 hours, T <sub>A</sub> = 125°C
Resistive Load		20	1200	ppm FSR	Internal R <sub>SET</sub>
Inductive Load				Ω	External R <sub>SET</sub>
DC PSRR		50	1	mH	T <sub>A</sub> = 25°C
Output Impedance				μA/V	
Output Current Leakage When Output Disabled		50		MΩ	
Output Current Leakage When Output Disabled		60		pA	
REFERENCE INPUT/OUTPUT					
Reference Input <sup>3</sup>					
Reference Input Voltage	4.95	5	5.05	V	For specified performance
DC Input Impedance	27	40		kΩ	
Reference Output					
Output Voltage	4.995	5	5.005		T <sub>A</sub> = 25°C
Reference TC <sup>3, 5</sup>		1.8	10	ppm/°C	
Output Noise (0.1 Hz to 10 Hz) <sup>3</sup>		10		μV p-p	
Noise Spectral Density <sup>3</sup>		100		nV/√Hz	At 10 kHz
Output Voltage Drift vs. Time <sup>3</sup>		50		ppm	Drift after 1000 hours, T <sub>A</sub> = 125°C
Capacitive Load <sup>3</sup>		600		nF	
Load Current <sup>3</sup>		5		mA	
Short-Circuit Current <sup>3</sup>		7		mA	
Load Regulation <sup>3</sup>		95		ppm/mA	

Parameter <sup>1</sup>	Min	Typ	Max	Unit	Test Conditions/Comments
DIGITAL INPUTS <sup>3</sup>					JEDEC compliant
Input High Voltage, $V_{IH}$	2			V	
Input Low Voltage, $V_{IL}$			0.8	V	
Input Current	-1		+1	$\mu$ A	Per pin
Pin Capacitance		10		pF	Per pin
DIGITAL OUTPUTS <sup>3</sup>					
SDO					
Output Low Voltage, $V_{OL}$			0.4	V	Sinking 200 $\mu$ A
Output High Voltage, $V_{OH}$	$DV_{CC} - 0.5$			V	Sourcing 200 $\mu$ A
High Impedance Leakage Current	-1		+1	$\mu$ A	
High Impedance Output Capacitance		5		pF	
FAULT					
Output Low Voltage, $V_{OL}$			0.4	V	10 k $\Omega$ pull-up resistor to $DV_{CC}$
Output Low Voltage, $V_{OL}$		0.6		V	At 2.5 mA
Output High Voltage, $V_{OH}$	3.6			V	10 k $\Omega$ pull-up resistor to $DV_{CC}$
POWER REQUIREMENTS					
$AV_{DD}$	10.8		40	V	
$AV_{SS}$	-26.4		0	V	
$ AV_{SS}  + AV_{DD}$	10.8		52.8	V	
$DV_{CC}$					
Input Voltage	2.7		5.5	V	Internal supply disabled
Output Voltage		4.5		V	$DV_{CC}$ , which can be overdriven up to 5.5V
Output Load Current <sup>3</sup>		5		mA	
Short-Circuit Current <sup>3</sup>		20		mA	
$AI_{DD}$					Outputs unloaded
		2.5	3	mA	Outputs disabled
		3.4	4	mA	Current output enabled
		3.9	4.4	mA	Voltage output enabled
$AI_{SS}$					Outputs unloaded
		0.24	0.3	mA	Outputs disabled
		0.5	0.6	mA	Current output enabled
		1.1	1.4	mA	Voltage output enabled
$DI_{CC}$			1	mA	$V_{IH} = DV_{CC}$ , $V_{IL} = GND$
Power Dissipation		128		mW	$AV_{DD} = 40$ V, $AV_{SS} = 0$ V, outputs unloaded
		120		mW	$AV_{DD} = +24$ V, $AV_{SS} = -24$ V, outputs unloaded

<sup>1</sup> Temperature range: -40°C to +105°C; typical at +25°C.

<sup>2</sup> When the AD5412/AD5422 is powered with  $AV_{SS} = 0$  V, INL for the 0 V to 5 V and 0 V to 10 V ranges is measured beginning from Code 256 for the AD5422 and Code 16 for the AD5412.

<sup>3</sup> Guaranteed by design and characterization; not production tested.

<sup>4</sup> For 0 mA to 20 mA and 0 mA to 24 mA ranges, INL is measured beginning from Code 256 for the AD5422 and Code 16 for the AD5412.

<sup>5</sup> The on-chip reference is production trimmed and tested at 25°C and 85°C. It is characterized from -40°C to +105°C.

$AV_{DD} = 15\text{ V to }26.4\text{ V}$ ,  $AV_{SS} = -26.4\text{ V to }-3\text{ V}/0\text{ V}$ ,  $AV_{DD} + |AV_{SS}| < 52.8\text{ V}$ ,  $GND = 0\text{ V}$ ,  $REFIN = 5\text{ V external}$ ;  $DV_{CC} = 2.7\text{ V to }5.5\text{ V}$ .  
 $V_{OUT}$ :  $R_{LOAD} = 1\text{ k}\Omega$ ,  $C_L = 200\text{ pF}$ ,  $I_{OUT}$ :  $R_{LOAD} = 350\ \Omega$ ; all specifications  $T_{MIN}$  to  $T_{MAX}$ , unless otherwise noted. Voltage over range enabled.

Table 3.

Parameter <sup>1</sup>	Min	Typ	Max	Unit	Test Conditions/Comments
VOLTAGE OUTPUT					
Output Voltage Ranges	0		5.5	V	
	0		11	V	
	-5.5		+5.5	V	
	-11		+11	V	
Accuracy					Output unloaded
Resolution	16			Bits	<a href="#">AD5422</a>
	12			Bits	<a href="#">AD5412</a>
Total Unadjusted Error (TUE)					
B Version	-0.13		+0.13	% FSR	
	-0.10	$\pm 0.01$	+0.10	% FSR	$T_A = 25^\circ\text{C}$
Relative Accuracy (INL) <sup>2</sup>	-0.008		+0.008	% FSR	<a href="#">AD5422</a>
	-0.032		+0.032	% FSR	<a href="#">AD5412</a>
Differential Nonlinearity (DNL)	-1		+1.3	LSB	Guaranteed monotonic
Bipolar Zero Error	-9		+9	mV	Bipolar output range
Bipolar Zero Error Temperature Coefficient (TC) <sup>3</sup>		$\pm 3$		ppm FSR/ $^\circ\text{C}$	Bipolar output range
Zero-Scale Error	-18		+18	mV	
Zero-Scale Error TC <sup>3</sup>		$\pm 2$		ppm FSR/ $^\circ\text{C}$	
Offset Error	-6		+6	mV	Unipolar output range
Offset Error TC <sup>3</sup>		$\pm 2$		ppm FSR/ $^\circ\text{C}$	Unipolar output range
Gain Error	-0.13		+0.13	% FSR	
Gain Error TC <sup>3</sup>		$\pm 3$		ppm FSR/ $^\circ\text{C}$	
Full-Scale Error	-0.13		+0.13	% FSR	
Full-Scale Error TC <sup>3</sup>		$\pm 2$		ppm FSR/ $^\circ\text{C}$	

<sup>1</sup> Temperature range:  $-40^\circ\text{C}$  to  $+105^\circ\text{C}$ ; typical at  $+25^\circ\text{C}$ .

<sup>2</sup> When the [AD5412/AD5422](#) is powered with  $AV_{SS} = 0\text{ V}$ , INL for the 0 V to 5.5 V and 0 V to 11 V ranges is measured beginning from Code 256 for the [AD5422](#) and Code 16 for the [AD5412](#).

<sup>3</sup> Guaranteed by design and characterization; not production tested.

**AC PERFORMANCE CHARACTERISTICS**

$AV_{DD} = 10.8\text{ V to }26.4\text{ V}$ ,  $AV_{SS} = -26.4\text{ V to }-3\text{ V/0 V}$ ,  $AV_{DD} + |AV_{SS}| < 52.8\text{ V}$ ,  $GND = 0\text{ V}$ ,  $REFIN = +5\text{ V external}$ ;  $DV_{CC} = 2.7\text{ V to }5.5\text{ V}$ .  
 $V_{OUT}$ :  $R_{LOAD} = 1\text{ k}\Omega$ ,  $C_L = 200\text{ pF}$ ,  $I_{OUT}$ :  $R_{LOAD} = 350\ \Omega$ ; all specifications  $T_{MIN}$  to  $T_{MAX}$ , unless otherwise noted.

**Table 4.**

Parameter <sup>1</sup>	Min	Typ	Max	Unit	Test Conditions/Comments
<b>DYNAMIC PERFORMANCE</b>					
<b>Voltage Output</b>					
Output Voltage Settling Time			25	$\mu\text{s}$	10 V step to $\pm 0.03\%$ FSR
		32		$\mu\text{s}$	20 V step to $\pm 0.03\%$ FSR
			18	$\mu\text{s}$	5 V step to $\pm 0.03\%$ FSR
		8		$\mu\text{s}$	512 LSB step to $\pm 0.03\%$ FSR (16-Bit LSB)
Slew Rate		0.8		V/ $\mu\text{s}$	
Power-On Glitch Energy		10		nV-sec	
Digital-to-Analog Glitch Energy		10		nV-sec	
Glitch Impulse Peak Amplitude		20		mV	
Digital Feedthrough		1		nV-sec	
Output Noise (0.1 Hz to 10 Hz Bandwidth)		0.1		LSB p-p	16-bit LSB
Output Noise (100 kHz Bandwidth)		200		$\mu\text{V rms}$	
1/f Corner Frequency		1		kHz	
Output Noise Spectral Density		150		nV/ $\sqrt{\text{Hz}}$	Measured at 10 kHz, midscale output, 10 V range
AC PSRR		-75		dB	200 mV 50 Hz/60 Hz sine wave superimposed on power supply voltage
<b>Current Output</b>					
Output Current Settling Time		10		$\mu\text{s}$	16 mA step to 0.1% FSR
		40		$\mu\text{s}$	16 mA step to 0.1% FSR, L = 1 mH
AC PSRR		-75		dB	200 mV 50 Hz/60 Hz sine wave superimposed on power supply voltage

<sup>1</sup> Guaranteed by characterization, not production tested.

**TIMING CHARACTERISTICS**

$AV_{DD} = 10.8\text{ V to }26.4\text{ V}$ ,  $AV_{SS} = -26.4\text{ V to }-3\text{ V/0 V}$ ,  $AV_{DD} + |AV_{SS}| < 52.8\text{ V}$ ,  $GND = 0\text{ V}$ ,  $REFIN = +5\text{ V external}$ ;  $DV_{CC} = 2.7\text{ V to }5.5\text{ V}$ .  
 $V_{OUT}$ :  $R_{LOAD} = 1\text{ k}\Omega$ ,  $C_L = 200\text{ pF}$ ,  $I_{OUT}$ :  $R_{LOAD} = 300\ \Omega$ ; all specifications  $T_{MIN}$  to  $T_{MAX}$ , unless otherwise noted.

**Table 5.**

Parameter <sup>1, 2, 3</sup>	Limit at $T_{MIN}$ , $T_{MAX}$	Unit	Description
<b>WRITE MODE</b>			
$t_1$	33	ns min	SCLK cycle time
$t_2$	13	ns min	SCLK low time
$t_3$	13	ns min	SCLK high time
$t_4$	13	ns min	LATCH delay time
$t_5$	5	$\mu\text{s min}$	LATCH high time
$t_6$	5	ns min	Data setup time
$t_7$	5	ns min	Data hold time
$t_8$	40	ns min	LATCH low time
$t_9$	20	ns min	CLEAR pulse width
$t_{10}$	5	$\mu\text{s max}$	CLEAR activation time

Parameter <sup>1, 2, 3</sup>	Limit at T <sub>MIN</sub> , T <sub>MAX</sub>	Unit	Description
<b>READBACK MODE</b>			
t <sub>11</sub>	90	ns min	SCLK cycle time
t <sub>12</sub>	40	ns min	SCLK low time
t <sub>13</sub>	40	ns min	SCLK high time
t <sub>14</sub>	13	ns min	LATCH delay time
t <sub>15</sub>	40	ns min	LATCH high time
t <sub>16</sub>	5	ns min	Data setup time
t <sub>17</sub>	5	ns min	Data hold time
t <sub>18</sub>	40	ns min	LATCH low time
t <sub>19</sub>	35	ns max	Serial output delay time (C <sub>L SDO</sub> <sup>4</sup> = 15 pF)
t <sub>20</sub>	35	ns max	LATCH rising edge to SDO tristate (C <sub>L SDO</sub> <sup>4</sup> = 15 pF)
<b>DAISY-CHAIN MODE</b>			
t <sub>21</sub>	90	ns min	SCLK cycle time
t <sub>22</sub>	40	ns min	SCLK low time
t <sub>23</sub>	40	ns min	SCLK high time
t <sub>24</sub>	13	ns min	LATCH delay time
t <sub>25</sub>	40	ns min	LATCH high time
t <sub>26</sub>	5	ns min	Data setup time
t <sub>27</sub>	5	ns min	Data hold time
t <sub>28</sub>	40	ns min	LATCH low time
t <sub>29</sub>	35	ns max	Serial output delay time (C <sub>L SDO</sub> <sup>4</sup> = 15 pF)

<sup>1</sup> Guaranteed by characterization; not production tested.

<sup>2</sup> All input signals are specified with t<sub>r</sub> = t<sub>f</sub> = 5 ns (10% to 90% of DV<sub>CC</sub>) and timed from a voltage level of 1.2 V.

<sup>3</sup> See Figure 2, Figure 3, and Figure 4.

<sup>4</sup> C<sub>L SDO</sub> = capacitive load on SDO output.

**Timing Diagrams**

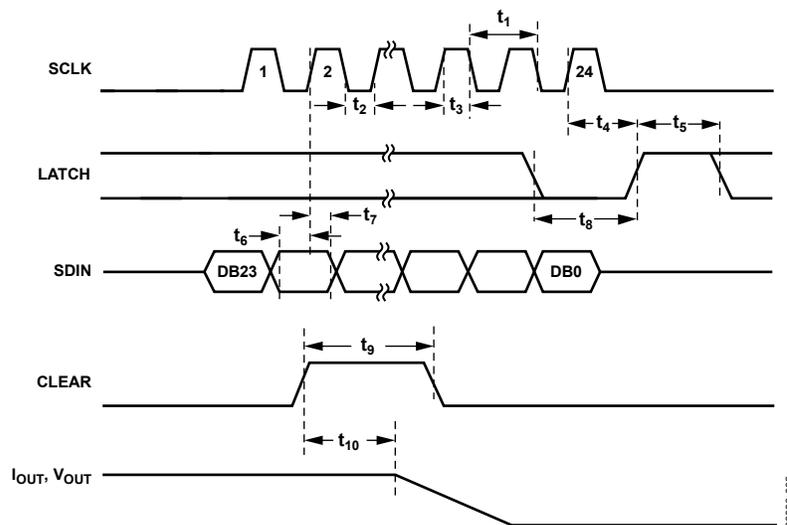

Figure 2. Write Mode Timing Diagram

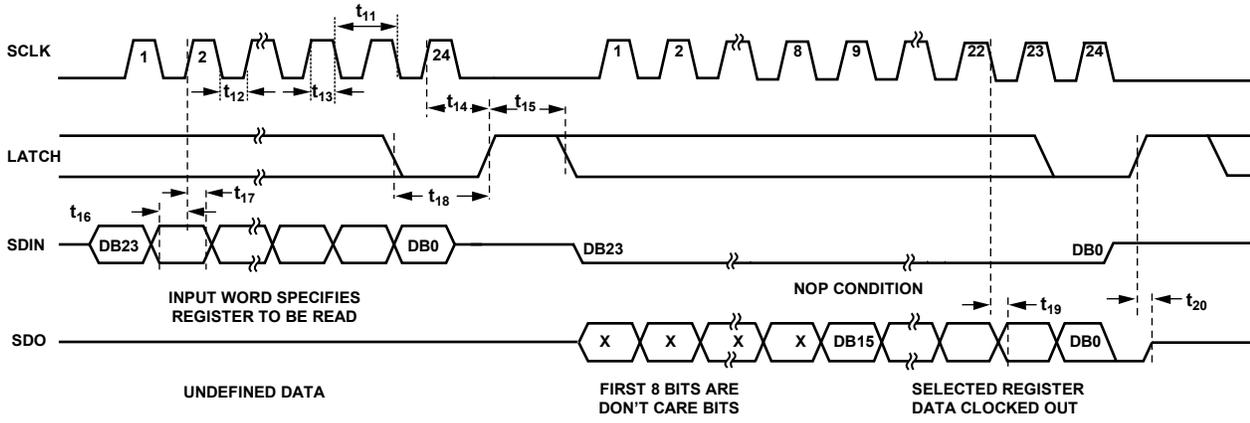

Figure 3. Readback Mode Timing Diagram

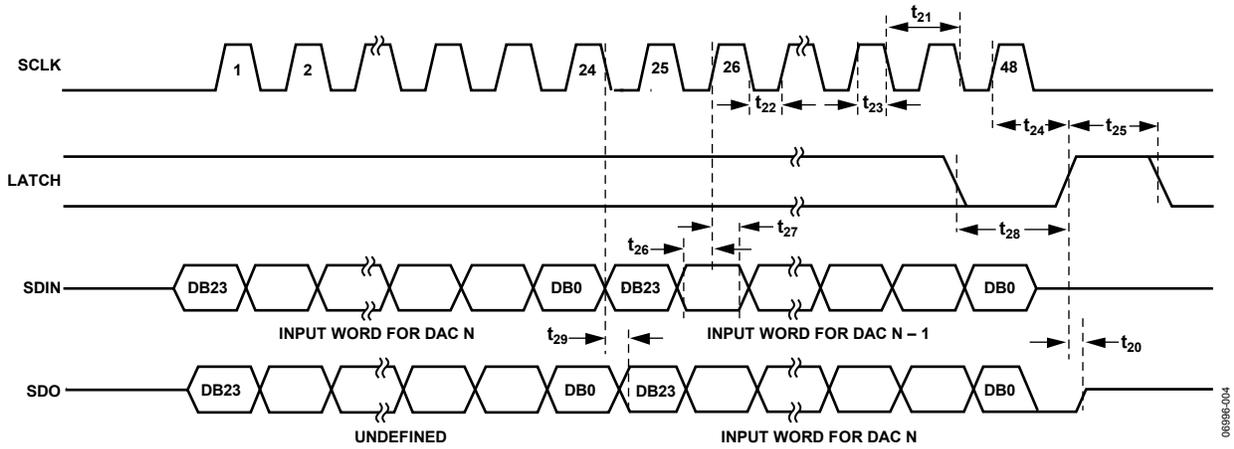

Figure 4. Daisy-Chain Mode Timing Diagram

## ABSOLUTE MAXIMUM RATINGS

$T_A = 25^\circ\text{C}$ , unless otherwise noted. Transient currents of up to 80 mA do not cause SCR latch-up.

Table 6.

Parameter	Rating
$AV_{DD}$ to GND	-0.3 V to +48 V
$AV_{SS}$ to GND	+0.3 V to -28 V
$AV_{DD}$ to $AV_{SS}$	-0.3 V to +60 V
$DV_{CC}$ to GND	-0.3 V to +7 V
Digital Inputs to GND	-0.3 V to $DV_{CC} + 0.3$ V or 7 V (whichever is less)
Digital Outputs to GND	-0.3 V to $DV_{CC} + 0.3$ V or 7 V (whichever is less)
REFIN/REFOUT to GND	-0.3 V to +7 V
$V_{OUT}$ to GND	$AV_{SS}$ to $AV_{DD}$
$I_{OUT}$ to GND	$AV_{SS}$ to $AV_{DD}$
Operating Temperature Range ( $T_A$ )	
Industrial <sup>1</sup>	-40°C to +105°C
Storage Temperature Range	-65°C to +150°C
Junction Temperature ( $T_J$ max)	125°C
24-Lead TSSOP_EP Package	
$\theta_{JA}$ Thermal Impedance <sup>2</sup>	35°C/W
40-Lead LFCSP Package	
$\theta_{JA}$ Thermal Impedance <sup>2</sup>	33°C/W
Power Dissipation	$(T_J \text{ max} - T_A)/\theta_{JA}$
Lead Temperature	JEDEC industry standard
Soldering	J-STD-020

<sup>1</sup> Power dissipated on chip must be derated to keep the junction temperature below 125°C, assuming that the maximum power dissipation condition is sourcing 24 mA into GND from  $I_{OUT}$  with a 4 mA on-chip current.

<sup>2</sup> Thermal impedance simulated values are based on JEDEC 252P thermal test board with thermal vias. See JEDEC JESD51.

Stresses at or above those listed under Absolute Maximum Ratings may cause permanent damage to the product. This is a stress rating only; functional operation of the product at these or any other conditions above those indicated in the operational section of this specification is not implied. Operation beyond the maximum operating conditions for extended periods may affect product reliability.

### ESD CAUTION



**ESD (electrostatic discharge) sensitive device.** Charged devices and circuit boards can discharge without detection. Although this product features patented or proprietary protection circuitry, damage may occur on devices subjected to high energy ESD. Therefore, proper ESD precautions should be taken to avoid performance degradation or loss of functionality.

PIN CONFIGURATIONS AND FUNCTION DESCRIPTIONS

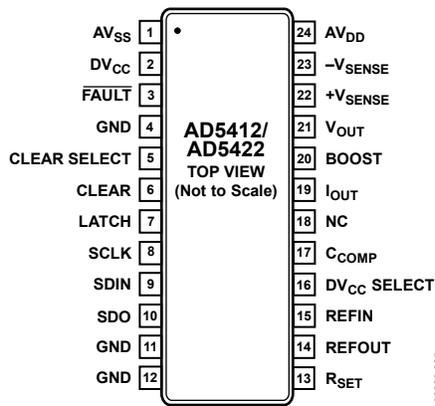

NOTES

1. NC = NO CONNECT
2. THE PADDLE CAN BE CONNECTED TO 0V IF THE OUTPUT VOLTAGE RANGE IS UNIPOLAR. THE PADDLE CAN BE LEFT ELECTRICALLY UNCONNECTED PROVIDED THAT A SUPPLY CONNECTION IS MADE AT THE AV<sub>SS</sub> PIN. IT IS RECOMMENDED THAT THE PADDLE BE THERMALLY CONNECTED TO A COPPER PLANE FOR ENHANCED THERMAL PERFORMANCE.

Figure 5. TSSOP Pin Configuration

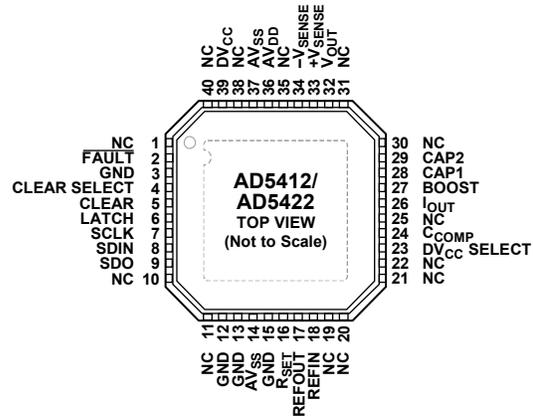

NOTES

1. NC = NO CONNECT.
2. THE EXPOSED PADDLE CAN BE CONNECTED TO 0V IF THE OUTPUT VOLTAGE RANGE IS UNIPOLAR. THE EXPOSED PADDLE CAN BE LEFT ELECTRICALLY UNCONNECTED PROVIDED THAT A SUPPLY CONNECTION IS MADE AT THE AV<sub>SS</sub> PIN. IT IS RECOMMENDED THAT THE PADDLE BE THERMALLY CONNECTED TO A COPPER PLANE FOR ENHANCED THERMAL PERFORMANCE.

Figure 6. LFCSP Pin Configuration

Table 7. Pin Function Descriptions

Pin No.		Mnemonic	Description
TSSOP	LFCSP		
1	14, 37	AV <sub>SS</sub>	Negative Analog Supply Pin. Voltage ranges from -3 V to -24 V. This pin can be connected to 0 V if the output voltage range is unipolar.
2	39	DV <sub>CC</sub>	Digital Supply Pin. Voltage ranges from 2.7 V to 5.5 V. This pin can also be configured as a 4.5 V LDO output by leaving the DV <sub>CC</sub> SELECT pin floating.
3	2	FAULT	Fault Alert. This pin is asserted low when an open circuit is detected in current mode or an overtemperature is detected. Open drain output must be connected to a pull-up resistor.
4, 12	3, 15	GND	These pins must be connected to 0 V.
18	1, 10, 11, 19, 20, 21, 22, 25, 30, 31, 35, 38, 40	NC	No Connection. Do not connect to these pins.
5	4	CLEAR SELECT	Selects the voltage output clear value, either zero-scale or midscale code (see Table 22).
6	5	CLEAR	Active High Input. Asserting this pin sets the current output to the bottom of the selected range or sets the voltage output to the user selected value (zero-scale or midscale).
7	6	LATCH	Positive Edge Sensitive Latch. A rising LATCH edge parallel loads the input shift register data into the DAC register, also updating the output.
8	7	SCLK	Serial Clock Input. Data is clocked into the shift register on the rising edge of SCLK. This operates at clock speeds of up to 30 MHz.
9	8	SDIN	Serial Data Input. Data must be valid on the rising edge of SCLK.
10	9	SDO	Serial Data Output. Used to clock data from the serial register in daisy-chain or readback mode. Data is valid on the rising edge of SCLK (see Figure 3 and Figure 4).
11	12, 13	GND	Ground Reference Pin.
13	16	R <sub>SET</sub>	An external, precision, low drift 15 kΩ current setting resistor can be connected to this pin to improve the I <sub>OUT</sub> temperature drift performance. See the AD5412/AD5422 Features section.
14	17	REFOUT	Internal Reference Voltage Output. REFOUT = 5 V ± 5 mV.
15	18	REFIN	External Reference Voltage Input. Reference input range is 4 V to 5 V. REFIN = 5 V for a specified performance.

Pin No.		Mnemonic	Description
TSSOP	LFCSP		
16	23	DV <sub>CC</sub> SELECT	When connected to GND, this pin disables the internal supply, and an external supply must be connected to the DV <sub>CC</sub> pin. Leave this pin unconnected to enable the internal supply. In this case, it is recommended to connect a 0.1 $\mu$ F capacitor between DV <sub>CC</sub> and GND. See the AD5412/AD5422 Features section.
17	24	C <sub>COMP</sub>	Optional compensation capacitor connection for the voltage output buffer. Connecting a 4 nF capacitor between this pin and the V <sub>OUT</sub> pin allows the voltage output to drive up to 1 $\mu$ F. It should be noted that the addition of this capacitor reduces the bandwidth of the output amplifier, increasing the settling time.
19	26	I <sub>OUT</sub>	Current Output Pin.
20	27	BOOST	Optional External Transistor Connection. Connecting an external transistor reduces the power dissipated in the AD5412/AD5422. See the AD5412/AD5422 Features section.
N/A	28, 29	CAP1, CAP2	Connection for Optional Output Filtering Capacitor. See the AD5412/AD5422 Features section.
21	32	V <sub>OUT</sub>	Buffered Analog Output Voltage. The output amplifier is capable of directly driving a 1 k $\Omega$ , 2000 pF load.
22	33	+V <sub>SENSE</sub>	Sense connection for the positive voltage output load connection.
23	34	-V <sub>SENSE</sub>	Sense connection for the negative voltage output load connection.
24	36	AV <sub>DD</sub>	Positive Analog Supply Pin. Voltage ranges from 10.8 V to 60 V.
25 (EPAD)	41 (EPAD)	Exposed paddle	Negative Analog Supply Pin. Voltage ranges from -3 V to -24 V. This paddle can be connected to 0 V if the output voltage range is unipolar. The paddle can be left electrically unconnected provided that a supply connection is made at the AV <sub>SS</sub> pin. It is recommended that the paddle be thermally connected to a copper plane for enhanced thermal performance.

TYPICAL PERFORMANCE CHARACTERISTICS

GENERAL

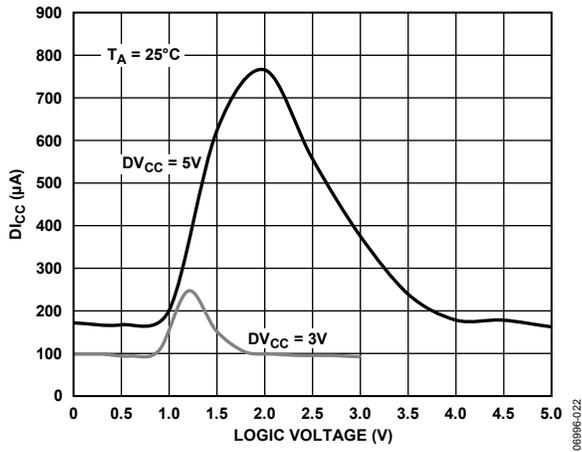

Figure 7.  $D_{Icc}$  vs. Logic Input Voltage

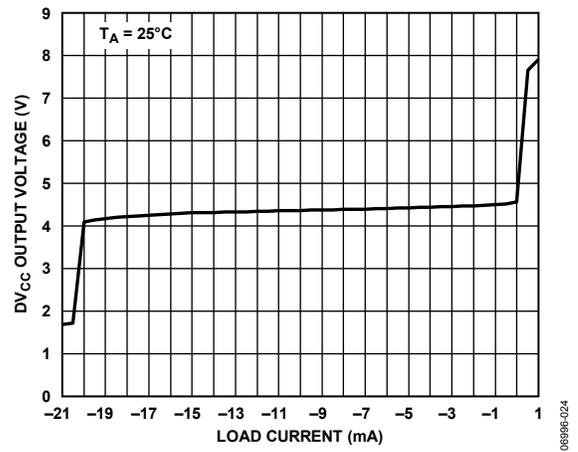

Figure 10.  $DV_{CC}$  Output Voltage vs. Load Current

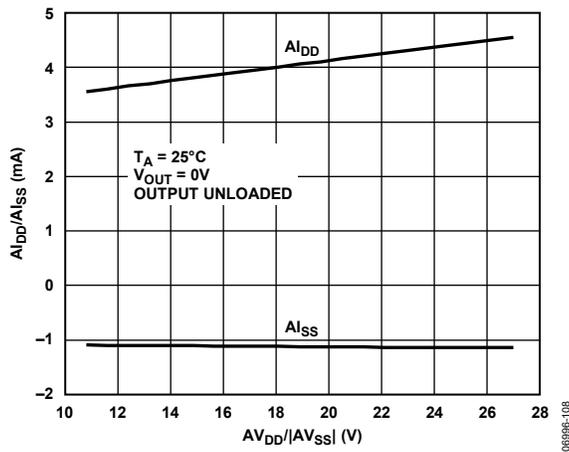

Figure 8.  $A_{I_{DD}}/A_{I_{SS}}$  vs.  $AV_{DD}/AV_{SS}$

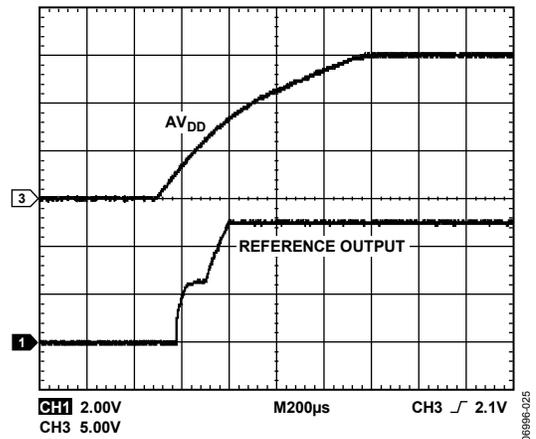

Figure 11. REFOUT Turn-on Transient

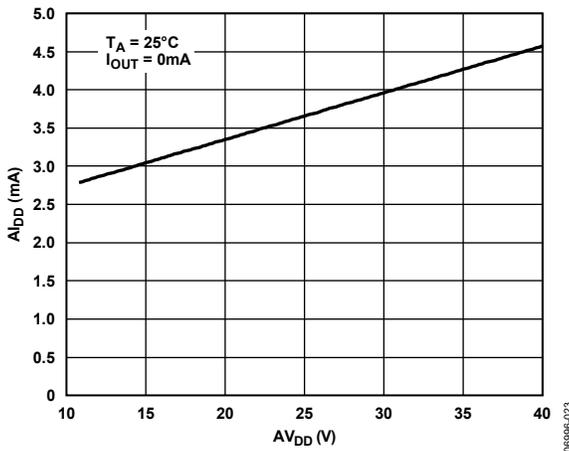

Figure 9.  $A_{I_{DD}}$  vs.  $AV_{DD}$

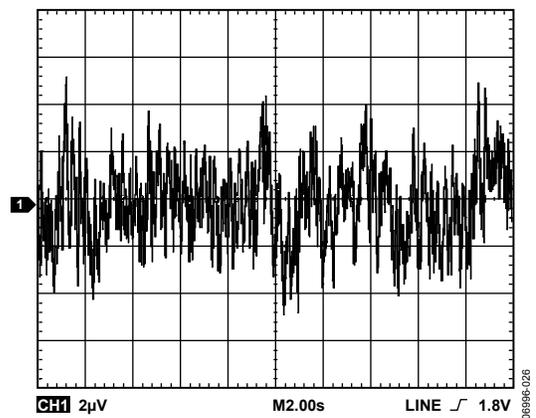

Figure 12. REFOUT Output Noise (0.1 Hz to 10 Hz Bandwidth)

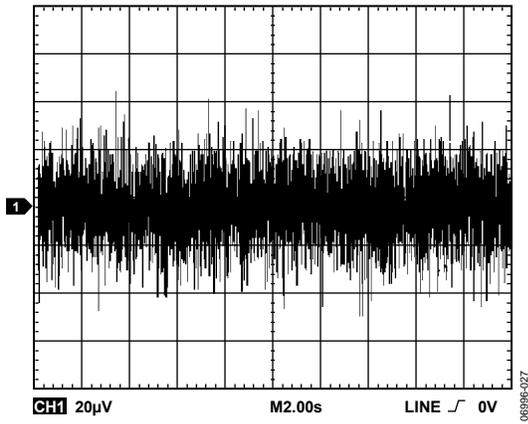

Figure 13. REFOUT Output Noise (100 kHz Bandwidth)

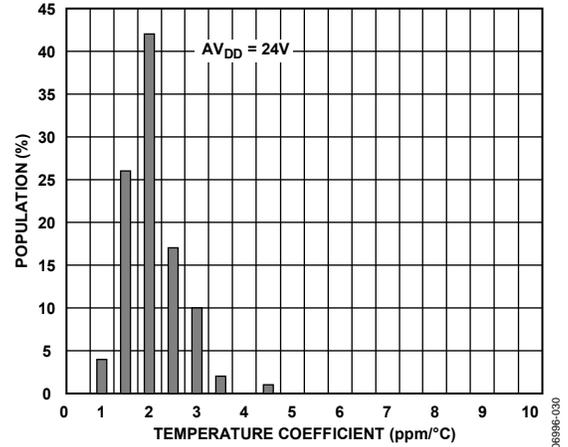

Figure 15. Reference Temperature Coefficient Histogram

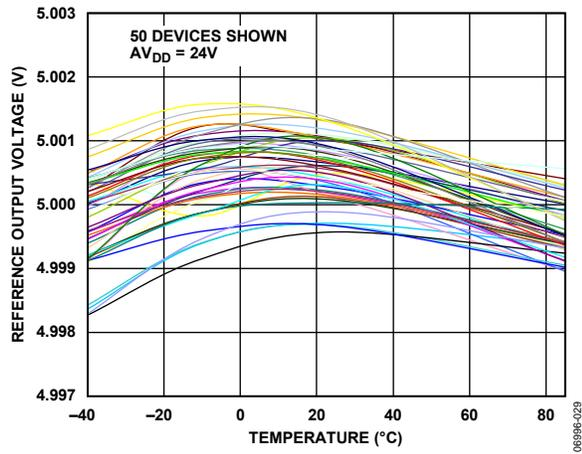

Figure 14. Reference Voltage vs. Temperature

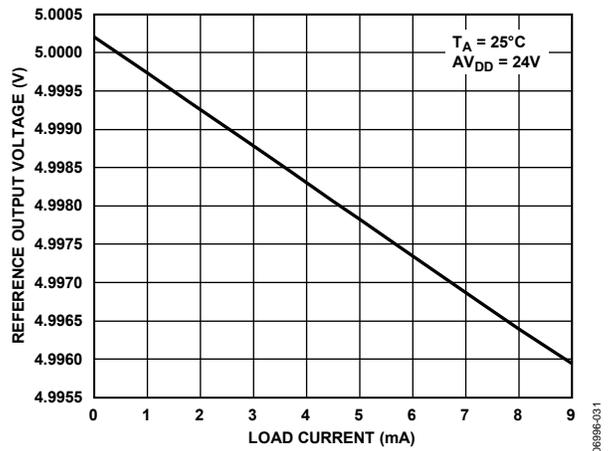

Figure 16. Reference Voltage vs. Load Current

VOLTAGE OUTPUT

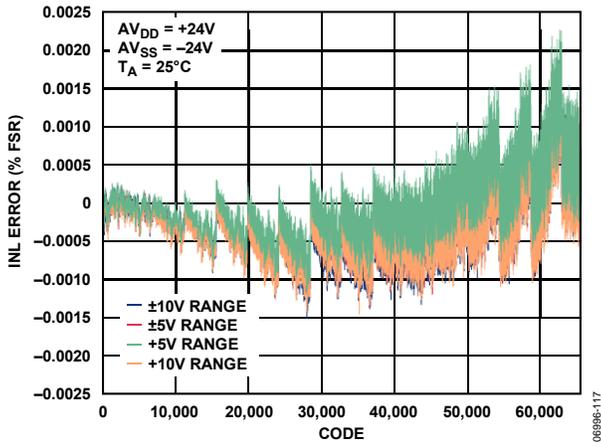

Figure 17. Integral Nonlinearity Error vs. DAC Code, Dual Supply

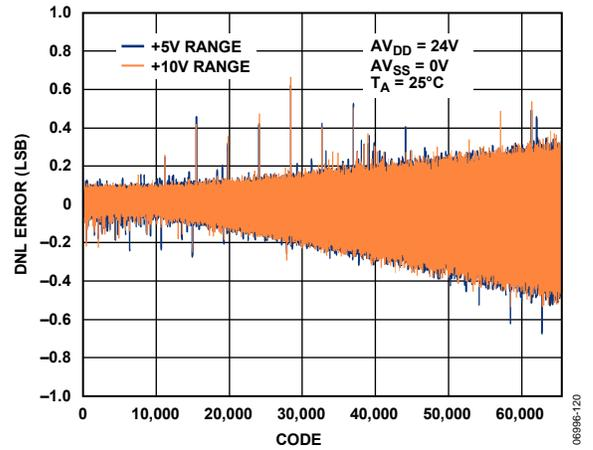

Figure 20. Differential Nonlinearity Error vs. DAC Code, Single Supply

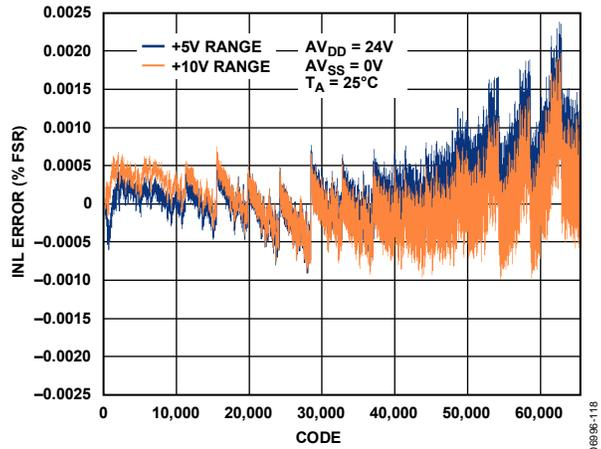

Figure 18. Integral Nonlinearity Error vs. DAC Code, Single Supply

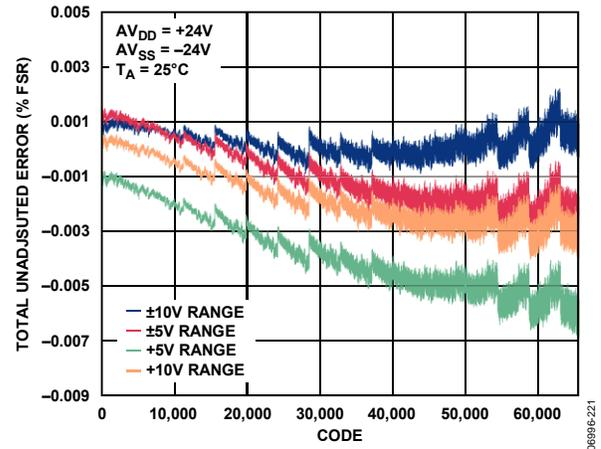

Figure 21. Total Unadjusted Error vs. DAC Code, Dual Supply

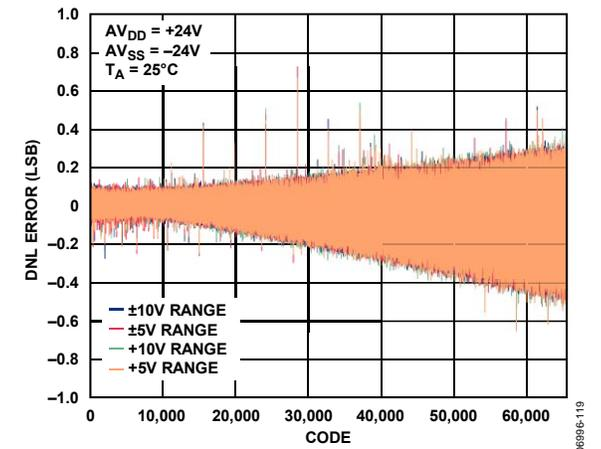

Figure 19. Differential Nonlinearity Error vs. DAC Code, Dual Supply

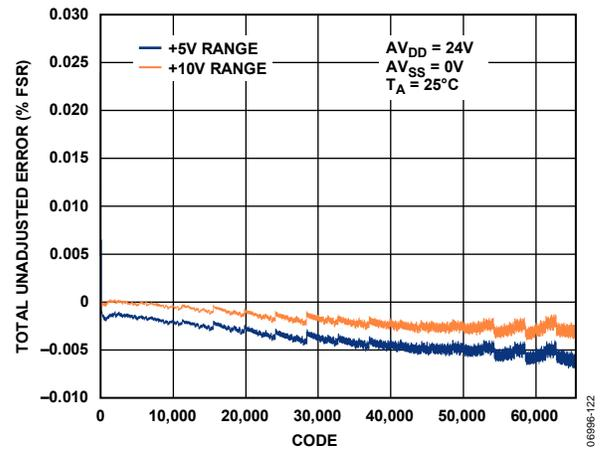

Figure 22. Total Unadjusted Error vs. DAC Code, Single Supply

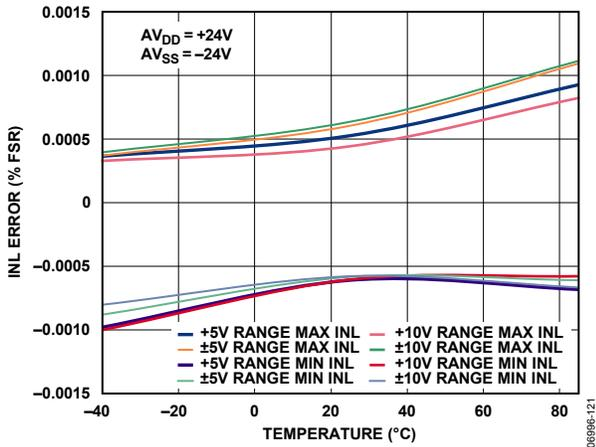

Figure 23. Integral Nonlinearity Error vs. Temperature

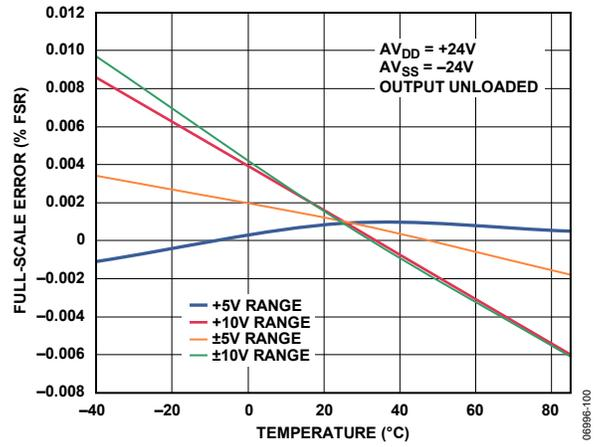

Figure 26. Full-Scale Error vs. Temperature

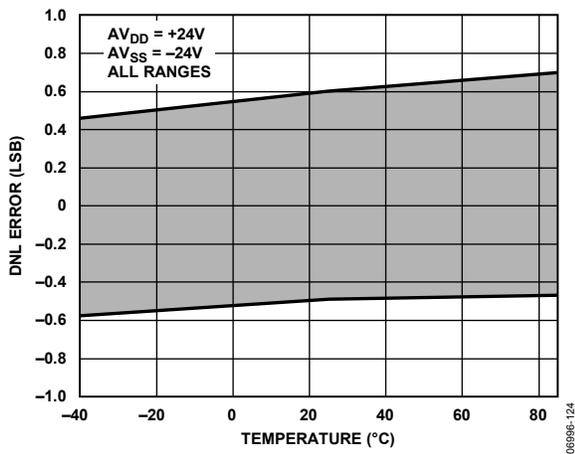

Figure 24. Differential Nonlinearity Error vs. Temperature

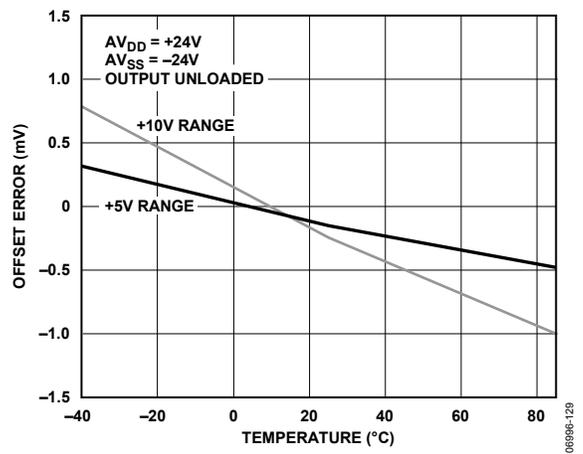

Figure 27. Offset Error vs. Temperature

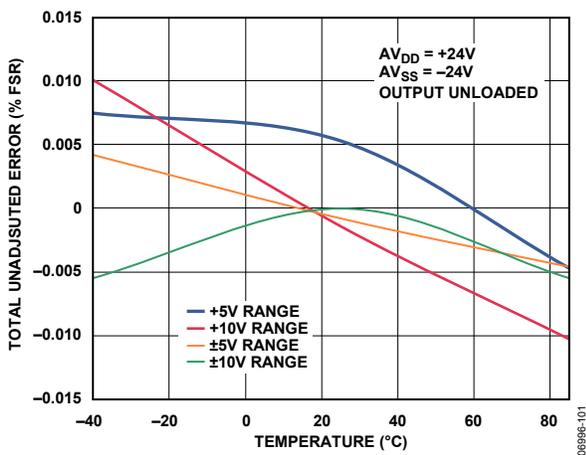

Figure 25. Total Unadjusted Error vs. Temperature

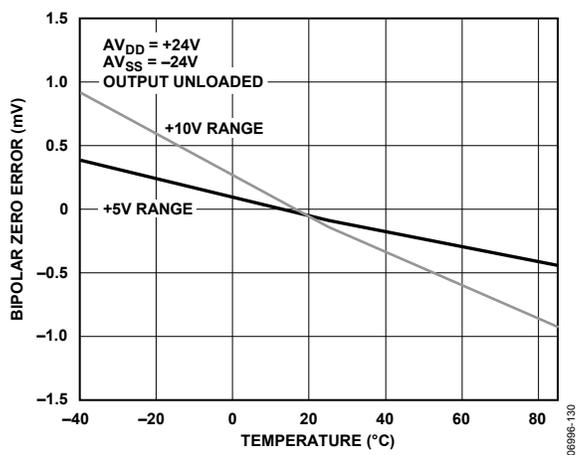

Figure 28. Bipolar Zero Error vs. Temperature

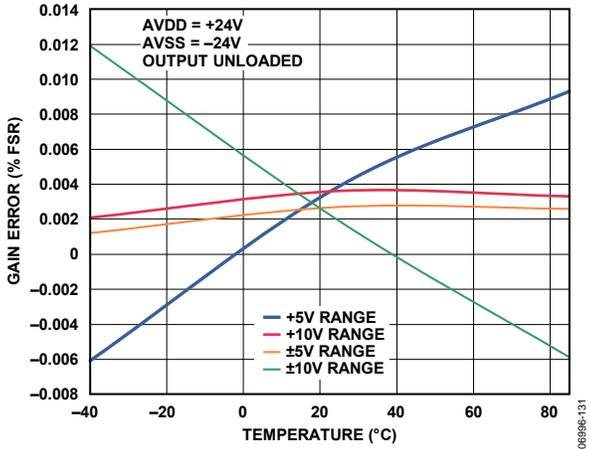

Figure 29. Gain Error vs. Temperature

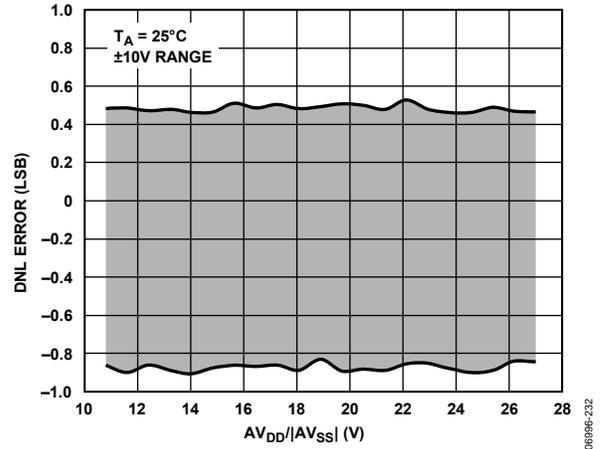

Figure 32. Differential Nonlinearity Error vs.  $AV_{DD}/AV_{SS}$

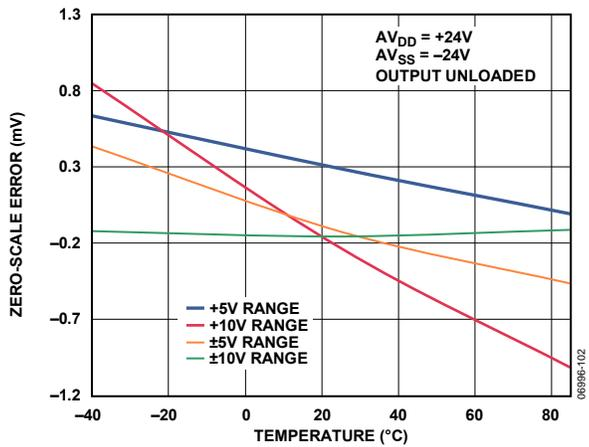

Figure 30. Zero-Scale Error vs. Temperature

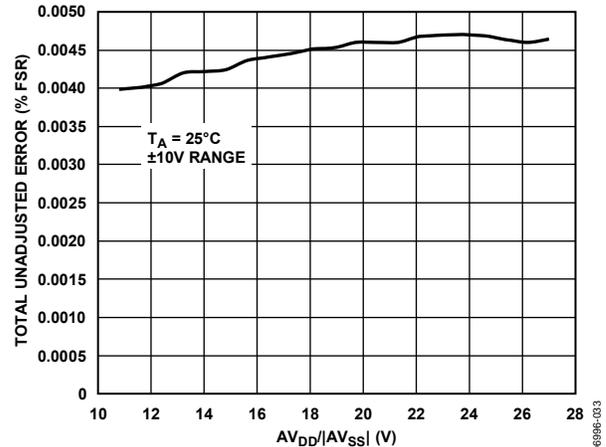

Figure 33. Total Unadjusted Error vs.  $AV_{DD}/AV_{SS}$

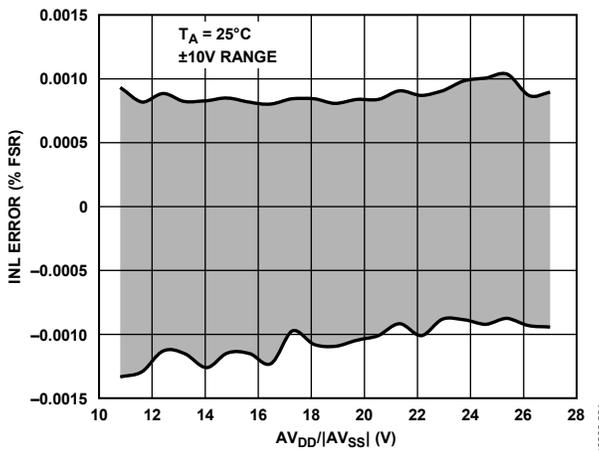

Figure 31. Integral Nonlinearity Error vs.  $AV_{DD}/AV_{SS}$

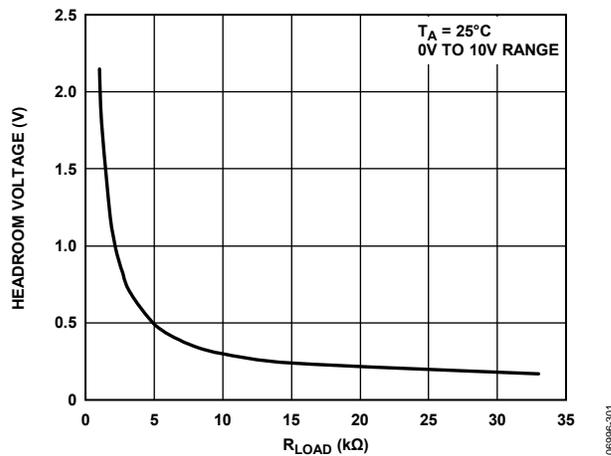

Figure 34.  $V_{OUT}$  Headroom

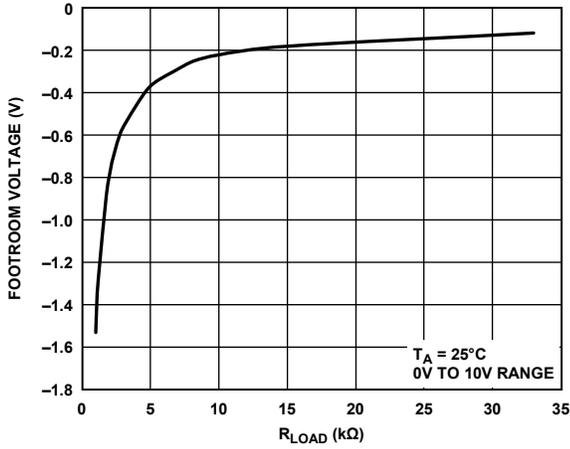

Figure 35.  $V_{out}$  Footroom

06996-302

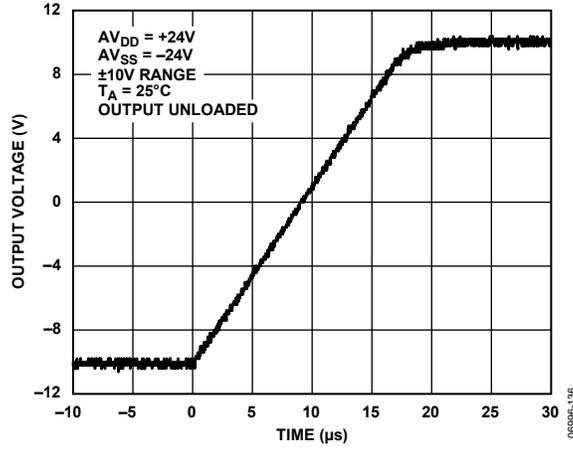

Figure 38. Full-Scale Positive Step

06996-136

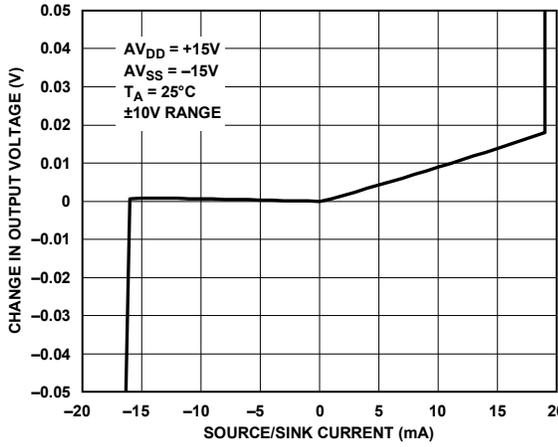

Figure 36. Source and Sink Capability of Output Amplifier, Full-Scale Code Loaded

06996-132

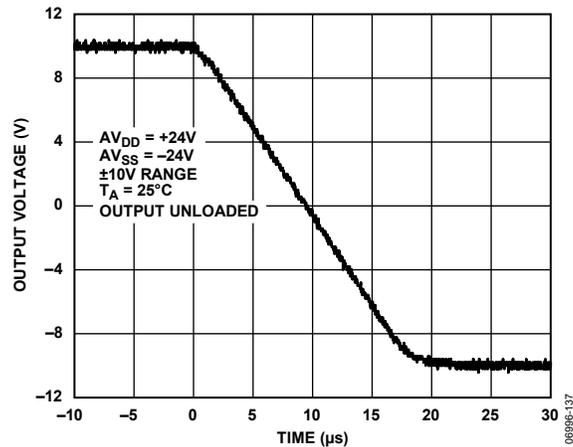

Figure 39. Full-Scale Negative Step

06996-137

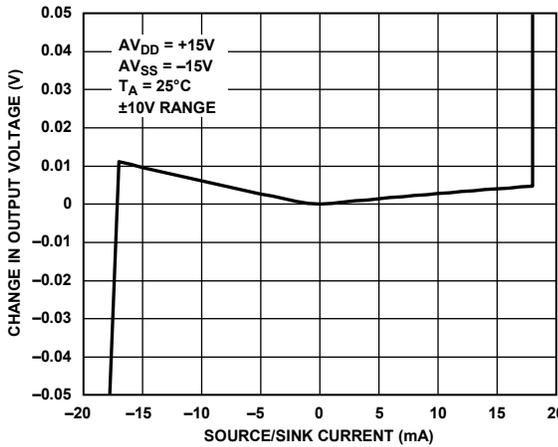

Figure 37. Source and Sink Capability of Output Amplifier, Zero-Scale Loaded

06996-035

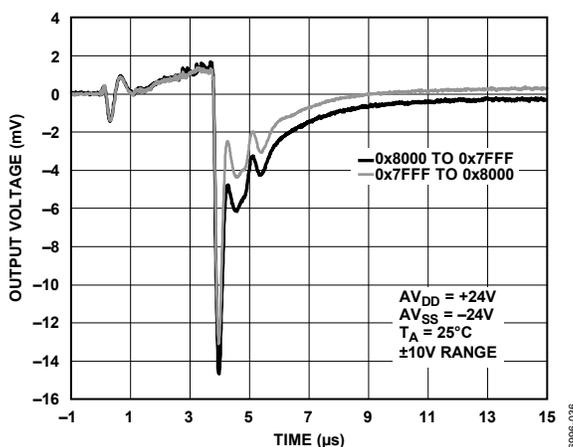

Figure 40. Digital-to-Analog Glitch

06996-036

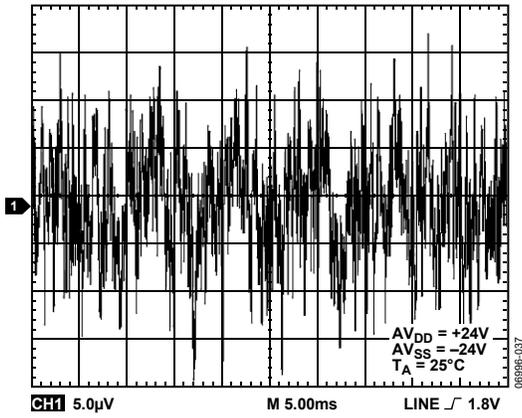

Figure 41. Peak-to-Peak Noise (0.1 Hz to 10 Hz Bandwidth)

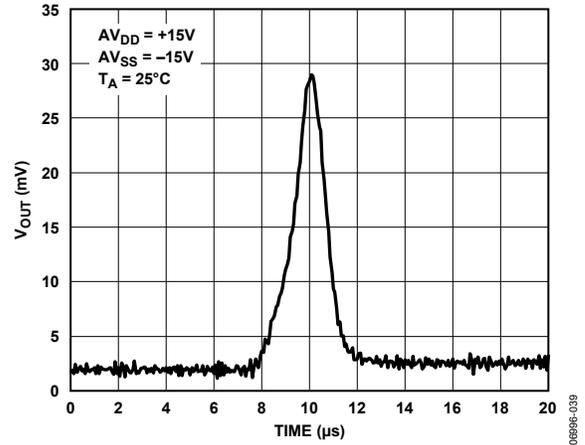

Figure 43. V<sub>OUT</sub> vs. Time on Power-Up

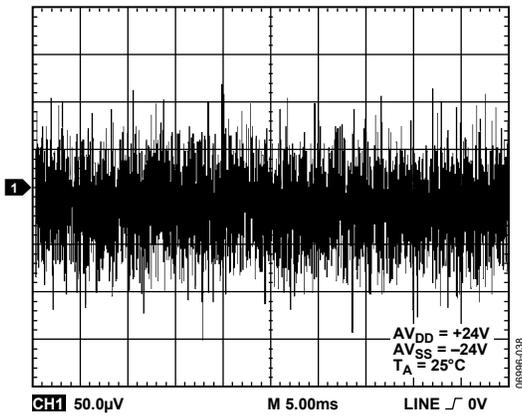

Figure 42. Peak-to-Peak Noise (100 kHz Bandwidth)

CURRENT OUTPUT

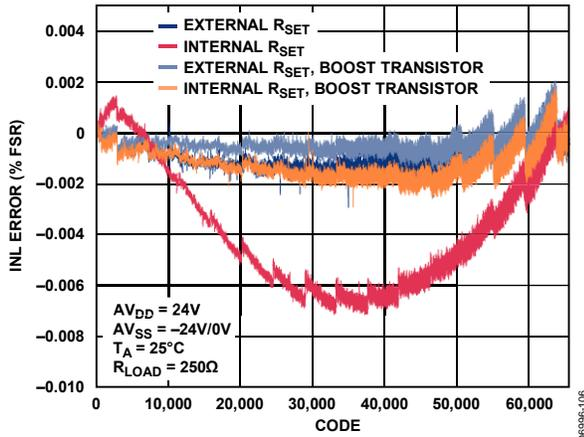

Figure 44. Integral Nonlinearity vs. Code

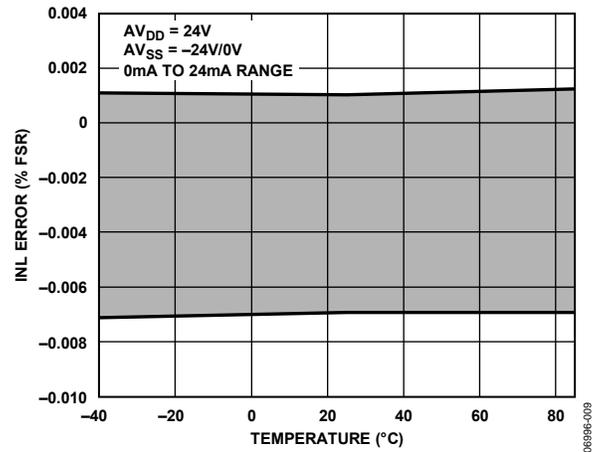

Figure 47. Integral Nonlinearity vs. Temperature, Internal RSET

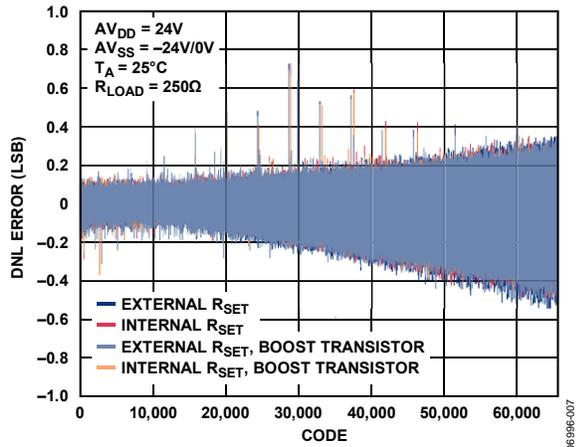

Figure 45. Differential Nonlinearity vs. Code

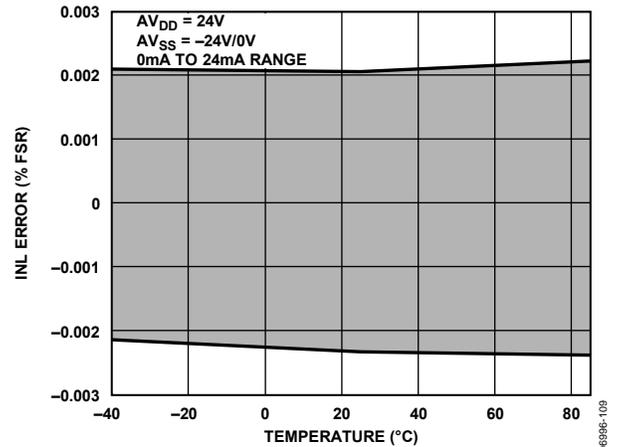

Figure 48. Integral Nonlinearity vs. Temperature, External RSET

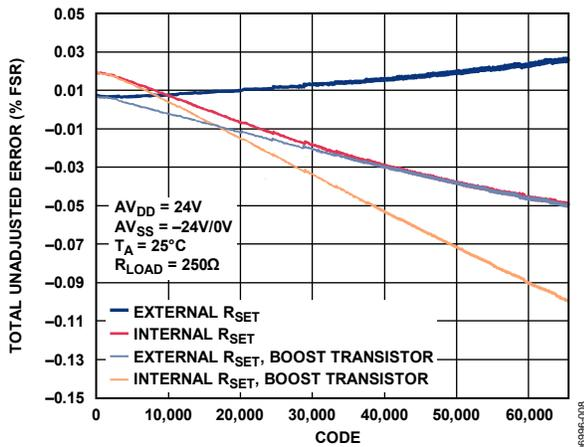

Figure 46. Total Unadjusted Error vs. Code

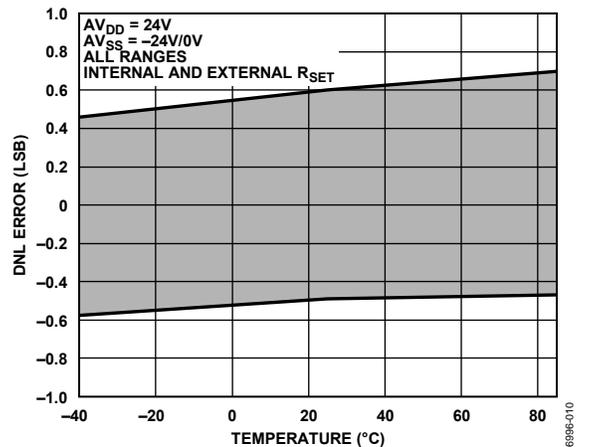

Figure 49. Differential Nonlinearity vs. Temperature

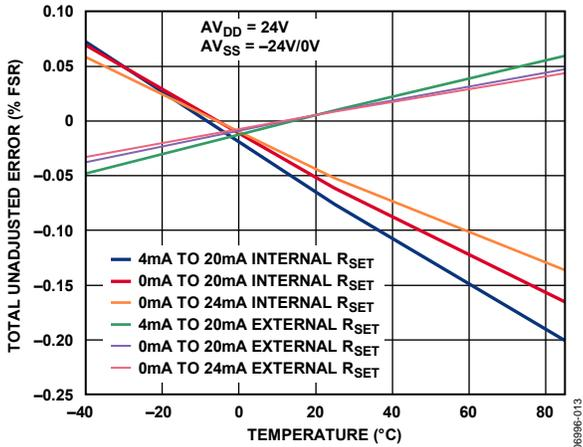

Figure 50. Total Unadjusted Error vs. Temperature

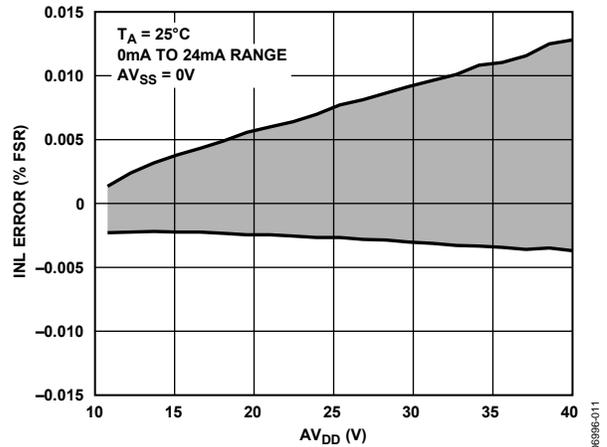

Figure 53. Integral Nonlinearity Error vs. AVDD, External RSET

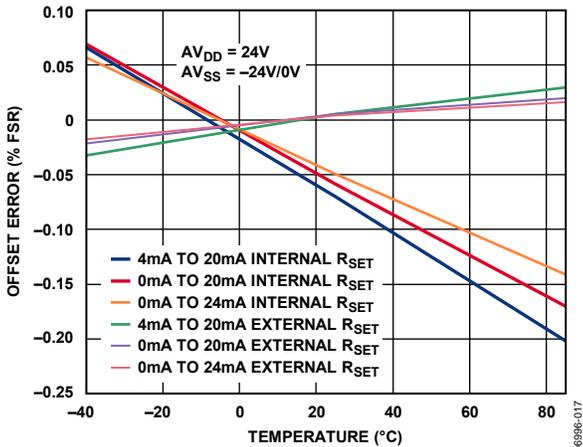

Figure 51. Offset Error vs. Temperature

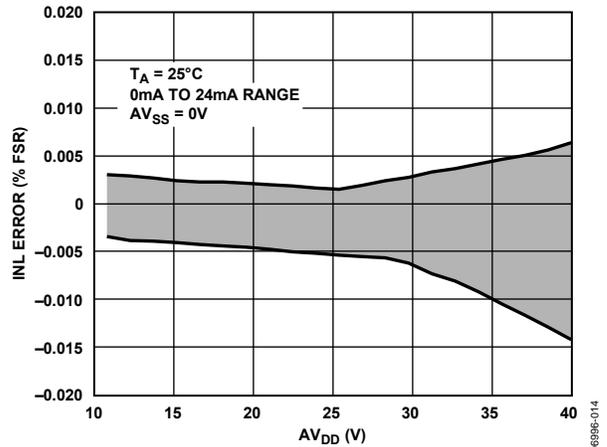

Figure 54. Integral Nonlinearity Error vs. AVDD, Internal RSET

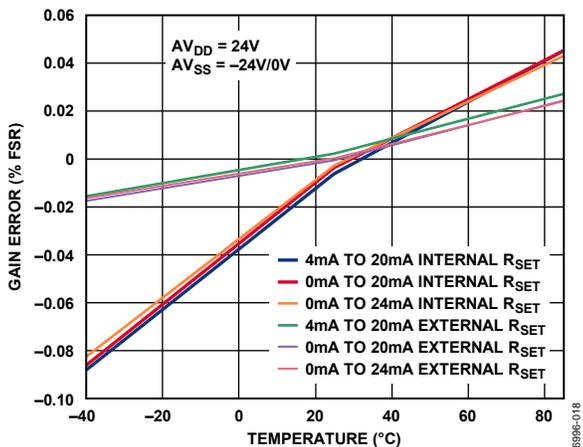

Figure 52. Gain Error vs. Temperature

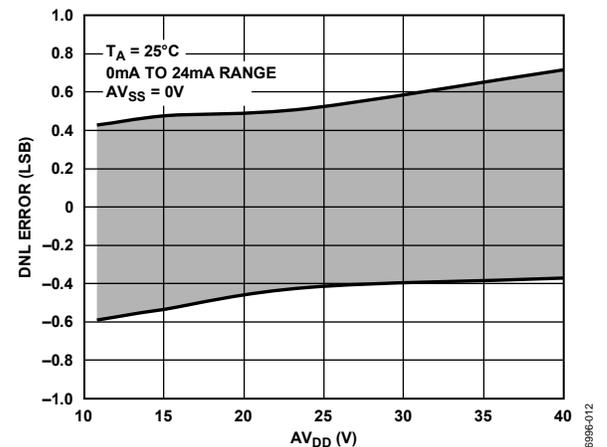

Figure 55. Differential Nonlinearity Error vs. AVDD, External RSET

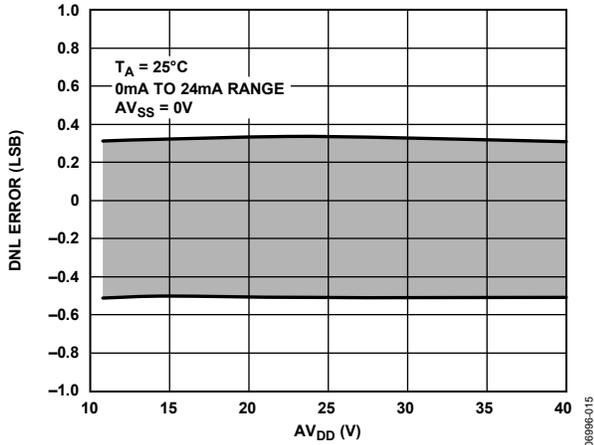

Figure 56. Differential Nonlinearity Error vs.  $AV_{DD}$ , Internal  $R_{SET}$

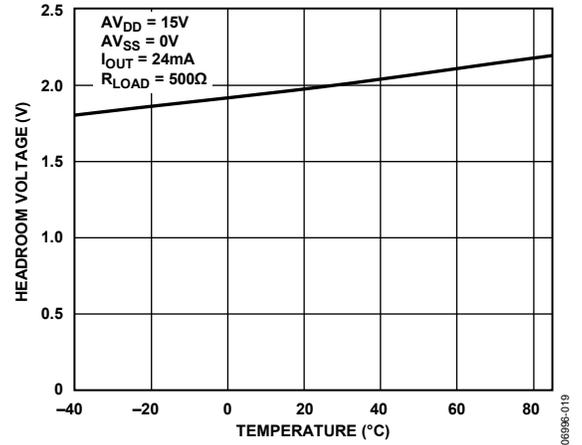

Figure 59. Compliance Voltage Headroom vs. Temperature

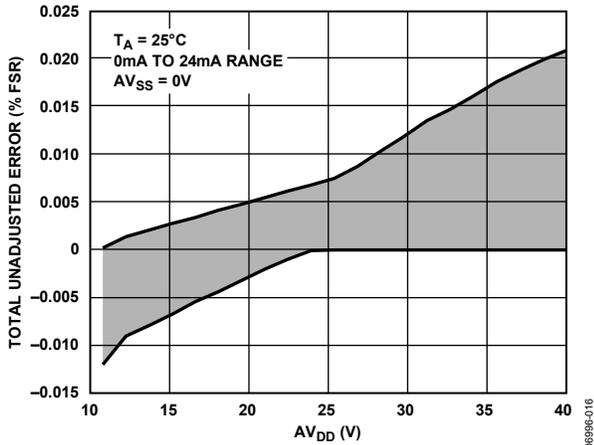

Figure 57. Total Unadjusted Error vs.  $AV_{DD}$ , External  $R_{SET}$

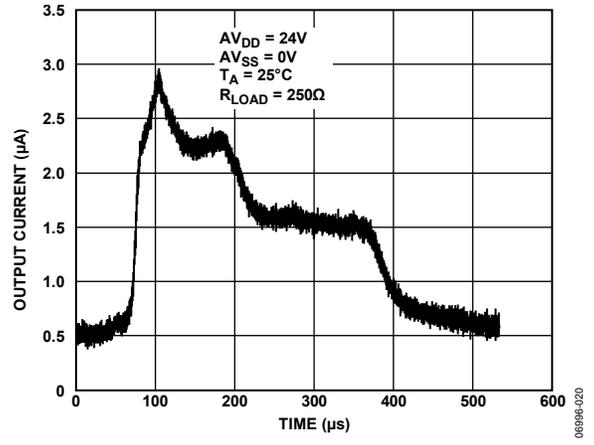

Figure 60. Output Current vs. Time on Power-Up

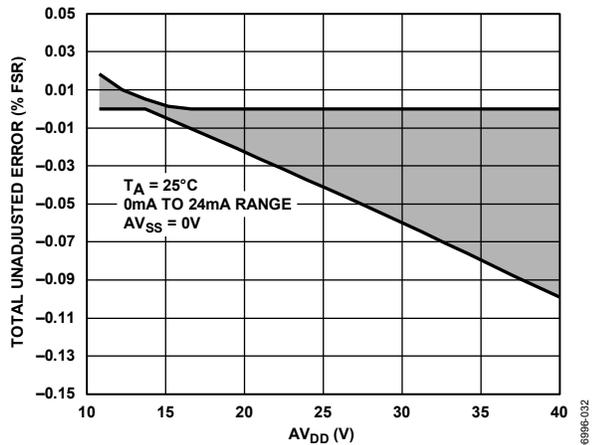

Figure 58. Total Unadjusted Error vs.  $AV_{DD}$ , Internal  $R_{SET}$

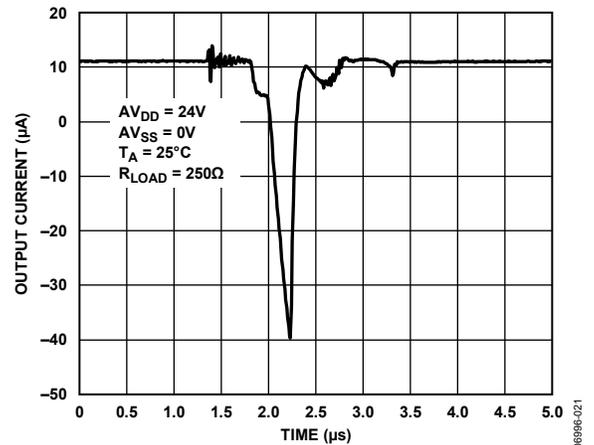

Figure 61. Output Current vs. Time on Output Enable

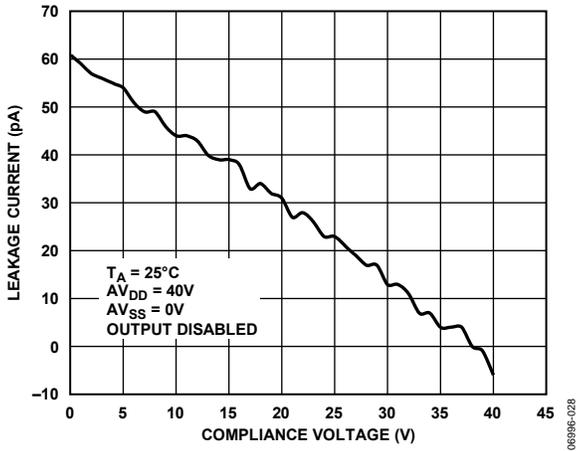

Figure 62. Output Leakage Current vs. Compliance Voltage

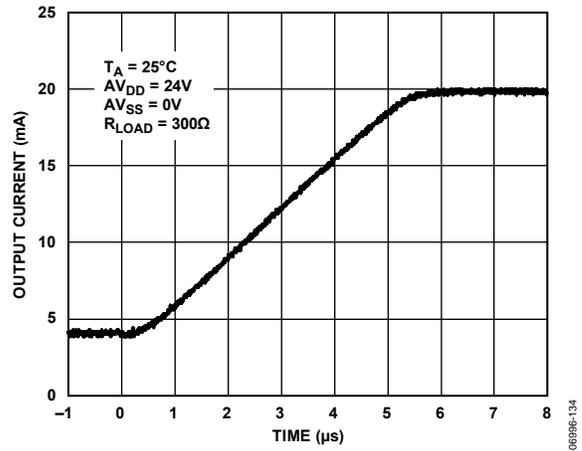

Figure 64. 4 mA to 20 mA Output Current Step

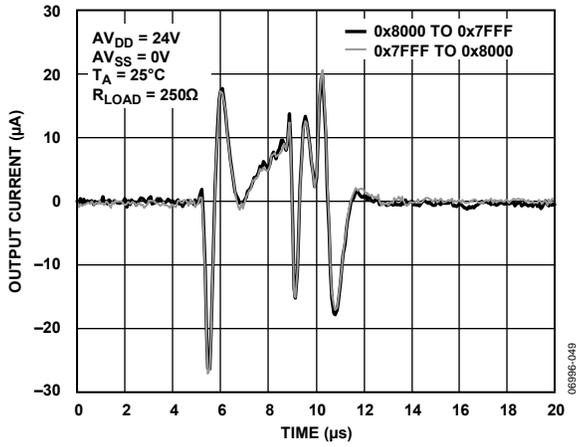

Figure 63. Digital to Analog Glitch

## TERMINOLOGY

### Relative Accuracy or Integral Nonlinearity (INL)

For the DAC, relative accuracy, or INL, is a measure of the maximum deviation, in LSBs, from a straight line passing through the endpoints of the DAC transfer function. A typical INL vs. code plot can be seen in Figure 17.

### Differential Nonlinearity (DNL)

DNL is the difference between the measured change and the ideal 1 LSB change between any two adjacent codes. A specified differential nonlinearity of  $\pm 1$  LSB maximum ensures monotonicity. This DAC is guaranteed monotonic by design. A typical DNL vs. code plot can be seen in Figure 19.

### Monotonicity

A DAC is monotonic if the output either increases or remains constant for increasing digital input code. The AD5412/AD5422 are monotonic over their full operating temperature range.

### Bipolar Zero Error

Bipolar zero error is the deviation of the analog output from the ideal half-scale output of 0 V when the DAC register is loaded with 0x8000 (straight binary coding) or 0x0000 (twos complement coding). A plot of bipolar zero error vs. temperature can be seen in Figure 28.

### Bipolar Zero Temperature Coefficient (TC)

Bipolar zero TC is a measure of the change in the bipolar zero error with a change in temperature. It is expressed in ppm FSR/ $^{\circ}$ C.

### Full-Scale Error

Full-scale error is a measure of the output error when full-scale code is loaded to the DAC register. Ideally, the output should be full-scale  $- 1$  LSB. Full-scale error is expressed in percent of full-scale range (% FSR).

### Negative Full-Scale Error/Zero-Scale Error

Negative full-scale error is the error in the DAC output voltage when 0x0000 (straight binary coding) or 0x8000 (twos complement coding) is loaded to the DAC register. Ideally, the output voltage should be negative full-scale  $- 1$  LSB. A plot of zero-scale error vs. temperature can be seen in Figure 30.

### Zero-Scale Temperature Coefficient (TC)

Zero-scale TC is a measure of the change in zero-scale error with a change in temperature. Zero-scale error TC is expressed in ppm FSR/ $^{\circ}$ C.

### Output Voltage Settling Time

Output voltage settling time is the amount of time it takes for the output to settle to a specified level for a full-scale input change.

### Slew Rate

The slew rate of a device is a limitation in the rate of change of the output voltage. The output slewing speed of a voltage-output DAC is usually limited by the slew rate of the amplifier used at its output. Slew rate is measured from 10% to 90% of the output signal and is expressed in V/ $\mu$ s.

### Gain Error

Gain error is a measure of the span error of the DAC. It is the deviation in slope of the DAC transfer characteristic from the ideal expressed in % FSR. A plot of gain error vs. temperature can be seen in Figure 29.

### Gain Error Temperature Coefficient (TC)

Gain error TC is a measure of the change in gain error with changes in temperature. Gain error TC is expressed in ppm FSR/ $^{\circ}$ C.

### Total Unadjusted Error (TUE)

TUE is a measure of the output error taking all the various errors into account, namely INL error, offset error, gain error, and output drift over supplies, temperature, and time. TUE is expressed in % FSR.

### Current Loop Voltage Compliance

The maximum voltage at the I<sub>OUT</sub> pin for which the output current is equal to the programmed value.

### Power-On Glitch Energy

Power-on glitch energy is the impulse injected into the analog output when the AD5412/AD5422 is powered on. It is specified as the area of the glitch in nV-sec. See Figure 43 and Figure 60.

### Digital-to-Analog Glitch Impulse

Digital-to-analog glitch impulse is the impulse injected into the analog output when the input code in the DAC register changes state, but the output voltage remains constant. It is normally specified as the area of the glitch in nV-sec and is measured when the digital input code is changed by 1 LSB at the major carry transition (0x7FFF to 0x8000). See Figure 40 and Figure 63.

### Glitch Impulse Peak Amplitude

Glitch impulse peak amplitude is the peak amplitude of the impulse injected into the analog output when the input code in the DAC register changes state. It is specified as the amplitude of the glitch in millivolt and is measured when the digital input code is changed by 1 LSB at the major carry transition (0x7FFF to 0x8000). See Figure 40 and Figure 63.

### Digital Feedthrough

Digital feedthrough is a measure of the impulse injected into the analog output of the DAC from the digital inputs of the DAC but is measured when the DAC output is not updated. It is specified in nV-sec and measured with a full-scale code change on the data bus.

**Power Supply Rejection Ratio (PSRR)**

PSRR indicates how the output of the DAC is affected by changes in the power supply voltage.

**Voltage Reference TC**

Voltage reference TC is a measure of the change in the reference output voltage with a change in temperature. The reference TC is calculated using the box method, which defines the TC as the maximum change in the reference output over a given temperature range expressed in ppm/°C, as follows:

$$TC = \left[ \frac{V_{REFmax} - V_{REFmin}}{V_{REFnom} \times TempRange} \right] \times 10^6$$

where:

$V_{REFmax}$  is the maximum reference output measured over the total temperature range.

$V_{REFmin}$  is the minimum reference output measured over the total temperature range.

$V_{REFnom}$  is the nominal reference output voltage, 5 V.

$TempRange$  is the specified temperature range, -40°C to +105°C.

**Load Regulation**

Load regulation is the change in reference output voltage due to a specified change in load current. It is expressed in ppm/mA.

## THEORY OF OPERATION

The AD5412/AD5422 are precision digital-to-current loop and voltage output converters designed to meet the requirements of industrial process control applications. They provide a high precision, fully integrated, low cost single-chip solution for generating current loop and unipolar/bipolar voltage outputs. Current ranges are 0 mA to 20 mA, 0 mA to 24 mA, and 4 mA to 20 mA; the voltage ranges available are 0 V to 5 V,  $\pm 5$  V, 0 V to 10 V, and  $\pm 10$  V; a 10% overrange is available on all voltage output ranges. The current and voltage outputs are available on separate pins, and only one is active at any time. The desired output configuration is user selectable via the control register.

## ARCHITECTURE

The DAC core architecture of the AD5412/AD5422 consists of two matched DAC sections. A simplified circuit diagram is shown in Figure 65. The four MSBs of the 12-/16-bit data-word are decoded to drive 15 switches, E1 to E15. Each of these switches connects one of 15 matched resistors to either ground or the reference buffer output. The remaining 8/12 bits of the data-word drive the S0 to S7/S11 switches of an 8-/12-bit voltage mode R-2R ladder network.

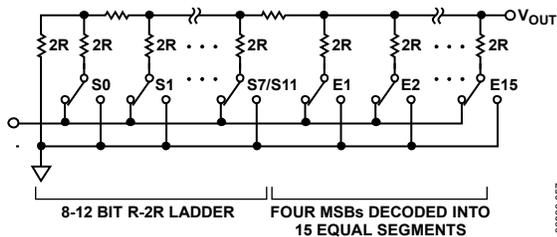

Figure 65. DAC Ladder Structure

The voltage output from the DAC core is either converted to a current (see Figure 66) which is then mirrored to the supply rail so that the application simply sees a current source output with respect to ground or it is buffered and scaled to output a software selectable unipolar or bipolar voltage range (see Figure 67). The current and voltage are output on separate pins and cannot be output simultaneously.

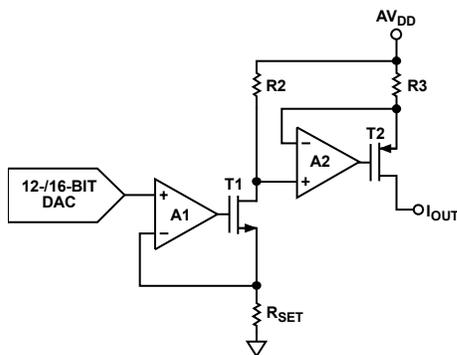

Figure 66. Voltage-to-Current Conversion Circuitry

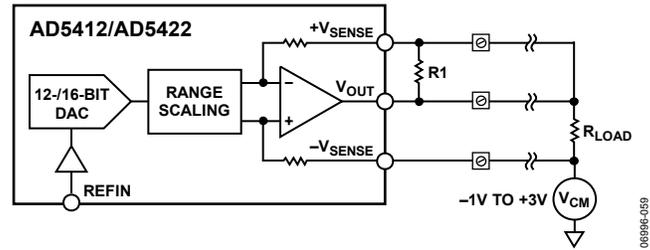

Figure 67. Voltage Output

### Voltage Output Amplifier

The voltage output amplifier is capable of generating both unipolar and bipolar output voltages. It is capable of driving a load of 1 k $\Omega$  in parallel with 1  $\mu$ F (with an external compensation capacitor) to GND. The source and sink capabilities of the output amplifier can be seen in Figure 37. The slew rate is 1 V/ $\mu$ s with a full-scale settling time of 25  $\mu$ s maximum (10 V step). Figure 67 shows the voltage output driving a load,  $R_{LOAD}$ , on top of a common-mode voltage ( $V_{CM}$ ) of  $-1$  V to  $+3$  V. In output module applications where a cable could possibly become disconnected from  $+V_{SENSE}$ , resulting in the amplifier loop being broken and possibly resulting in large destructive voltages on  $V_{OUT}$ , include an optional resistor ( $R_1$ ) between  $+V_{SENSE}$  and  $V_{OUT}$ , as shown in Figure 67, of a value between 2 k $\Omega$  and 5 k $\Omega$  to ensure the amplifier loop is kept closed. If remote sensing of the load is not required, connect  $+V_{SENSE}$  directly to  $V_{OUT}$  and connect  $-V_{SENSE}$  directly to GND. When changing ranges on the voltage output, a glitch may occur. For this reason, it is recommended that the output be disabled by setting the OUTEN bit of the control register to logic low before changing the output voltage range; this prevents a glitch from occurring.

### Driving Large Capacitive Loads

The voltage output amplifier is capable of driving capacitive loads of up to 1  $\mu$ F with the addition of a nonpolarized 4 nF compensation capacitor between the  $C_{COMP}$  and  $V_{OUT}$  pins. Without the compensation capacitor, up to 20 nF capacitive loads can be driven.

**SERIAL INTERFACE**

The AD5412/AD5422 are controlled over a versatile 3-wire serial interface that operates at clock rates of up to 30 MHz. It is compatible with SPI, QSPI™, MICROWIRE, and DSP standards.

**Input Shift Register**

The input shift register is 24 bits wide. Data is loaded into the device MSB first as a 24-bit word under the control of a serial clock input, SCLK. Data is clocked in on the rising edge of SCLK. The input register consists of eight address bits and 16 data bits, as shown in Table 8. The 24-bit word is unconditionally latched on the rising edge of the LATCH pin. Data continues to be clocked in irrespective of the state of LATCH. On the rising edge of LATCH, the data that is present in the input register is latched; in other words, the last 24 bits to be clocked in before the rising edge of LATCH is the data that is latched. The timing diagram for this operation is shown in Figure 2.

**Table 8. Input Shift Register Format**

MSB		LSB
D23 to D16	D15 to D0	
Address byte	Data-word	

**Table 9. Address Byte Functions**

Address Word	Function
00000000	No operation (NOP)
00000001	Data register
00000010	Readback register value as per read address (see Table 10)
01010101	Control register
01010110	Reset register

**Standalone Operation**

The serial interface works with both a continuous and non-continuous serial clock. A continuous SCLK source can be used only if LATCH is taken high after the correct number of data bits have been clocked in. In gated clock mode, a burst clock containing the exact number of clock cycles must be used, and LATCH must be taken high after the final clock to latch the data. The rising edge of SCLK that clocks in the MSB of the data-word marks the beginning of the write cycle. Exactly 24 rising clock edges must be applied to SCLK before LATCH is brought high. If LATCH is brought high before the 24<sup>th</sup> rising SCLK edge, the data written is invalid. If more than 24 rising SCLK edges are applied before LATCH is brought high, the input data is also invalid.

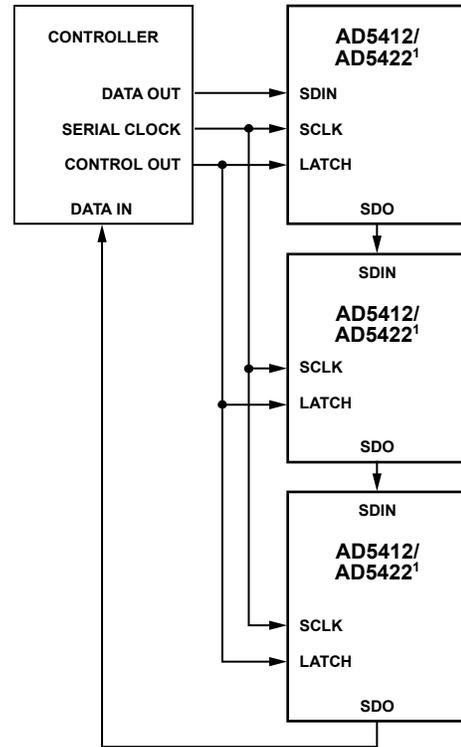

<sup>1</sup>ADDITIONAL PINS OMITTED FOR CLARITY.

06896-080

Figure 68. Daisy Chaining the AD5412/AD5422

**Daisy-Chain Operation**

For systems that contain several devices, the SDO pin can be used to daisy-chain the devices together as shown in Figure 68. This daisy-chain mode can be useful in system diagnostics and in reducing the number of serial interface lines. Daisy-chain mode is enabled by setting the DCEN bit of the control register to 1. The first rising edge of SCLK that clocks in the MSB of the data-word marks the beginning of the write cycle. SCLK is continuously applied to the input shift register. If more than 24 clock pulses are applied, the data ripples out of the shift register and appears on the SDO line. This data is valid on the rising edge of SCLK, having been clocked out on the previous falling SCLK edge. By connecting the SDO of the first device to the SDIN input of the next device in the chain, a multidevice interface is constructed. Each device in the system requires 24 clock pulses. Therefore, the total number of clock cycles must equal 24 × n, where n is the total number of AD5412/AD5422 devices in the chain. When the serial transfer to all devices is complete, LATCH is taken high. This latches the input data in each device in the daisy chain. The serial clock can be a continuous or a gated clock.

A continuous SCLK source can be used only if LATCH is taken high after the correct number of clock cycles. In gated clock mode, a burst clock containing the exact number of clock cycles must be used, and LATCH must be taken high after the final clock to latch the data (see Figure 4 for a timing diagram).

**Readback Operation**

Readback mode is invoked by setting the address byte and read address when writing to the input register (see Table 10 and Table 12). The next write to the AD5412/AD5422 should be a NOP command, which clocks out the data from the previously addressed register as shown in Figure 3.

By default the SDO pin is disabled after having addressed the AD5412/AD5422 for a read operation; a rising edge on LATCH enables the SDO pin in anticipation of data being clocked out. After the data has been clocked out on SDO, a rising edge on LATCH disables (tristate) the SDO pin. To read back the data register, for example, implement the following sequence:

1. Write 0x020001 to the input register. This configures the part for read mode with the data register selected.
2. Follow this with a second write: a NOP condition, which is 0x000000. During this write, the data from the register is clocked out on the SDO line.

**Table 10. Read Address Decoding**

Read Address	Function
00	Read status register
01	Read data register
10	Read control register

**POWER-ON STATE**

During power-on of the AD5412/AD5422, the power-on-reset circuit ensures that all registers are loaded with zero-code. As such, both outputs are disabled; that is, the V<sub>OUT</sub> and I<sub>OUT</sub> pins are in tristate. The +V<sub>SENSE</sub> pin is internally connected to ground through a 30 kΩ resistor. Therefore, if the V<sub>OUT</sub> and +V<sub>SENSE</sub> pins are connected together, V<sub>OUT</sub> is effectively clamped to ground through a 30 kΩ resistor. Also upon power-on, internal calibration registers are read, and the data is applied to internal calibration circuitry. For a reliable read operation, there must be sufficient voltage on the AV<sub>DD</sub> supply when the read event is triggered by the DV<sub>CC</sub> power supply powering up. Powering up the DV<sub>CC</sub> supply after the AV<sub>DD</sub> supply has reached at least 5 V ensures this. If DV<sub>CC</sub> and AV<sub>DD</sub> are powered up simultaneously, then the supplies should be powered up at a rate greater than, typically, 5000 V/sec. If the internal DV<sub>CC</sub> is enabled, the supplies should be powered up at a rate greater than, typically, 2000 V/sec. If this cannot be achieved, issue a reset command to the AD5412/AD5422 after power-on; this performs a power-on-reset event, reading the calibration registers and ensures specified operation of the AD5412/AD5422. To ensure correct calibration and to allow the internal reference to settle to its correct trim value, 40 μs should be allowed after a successful power on reset.

**Table 12. Input Shift Register Contents for a Read Operation**

MSB								LSB			
D23	D22	D21	D20	D19	D18	D17	D16	D15 to D2		D1	D0
0	0	0	0	0	0	1	0	X <sup>1</sup>		Read address	

<sup>1</sup>X = don't care.

**Voltage Output**

For a unipolar voltage output range, the output voltage can be expressed as

$$V_{OUT} = V_{REFIN} \times Gain \left[ \frac{D}{2^N} \right]$$

For a bipolar voltage output range, the output voltage can be expressed as

$$V_{OUT} = V_{REFIN} \times Gain \left[ \frac{D}{2^N} \right] - \frac{Gain \times V_{REFIN}}{2}$$

where:

D is the decimal equivalent of the code loaded to the DAC.

N is the bit resolution of the DAC.

V<sub>REFIN</sub> is the reference voltage applied at the REFIN pin.

Gain is an internal gain whose value depends on the output range selected by the user as shown in Table 11.

**Table 11. Internal Gain Value**

Output Range	Gain Value
+5 V	1
+10 V	2
±5 V	2
±10 V	4

**Current Output**

For the 0 mA to 20 mA, 0 mA to 24 mA, and 4 mA to 20 mA current output ranges, the output current is respectively expressed as

$$I_{OUT} = \left[ \frac{20 \text{ mA}}{2^N} \right] \times D$$

$$I_{OUT} = \left[ \frac{24 \text{ mA}}{2^N} \right] \times D$$

$$I_{OUT} = \left[ \frac{16 \text{ mA}}{2^N} \right] \times D + 4 \text{ mA}$$

where:

D is the decimal equivalent of the code loaded to the DAC.

N is the bit resolution of the DAC.

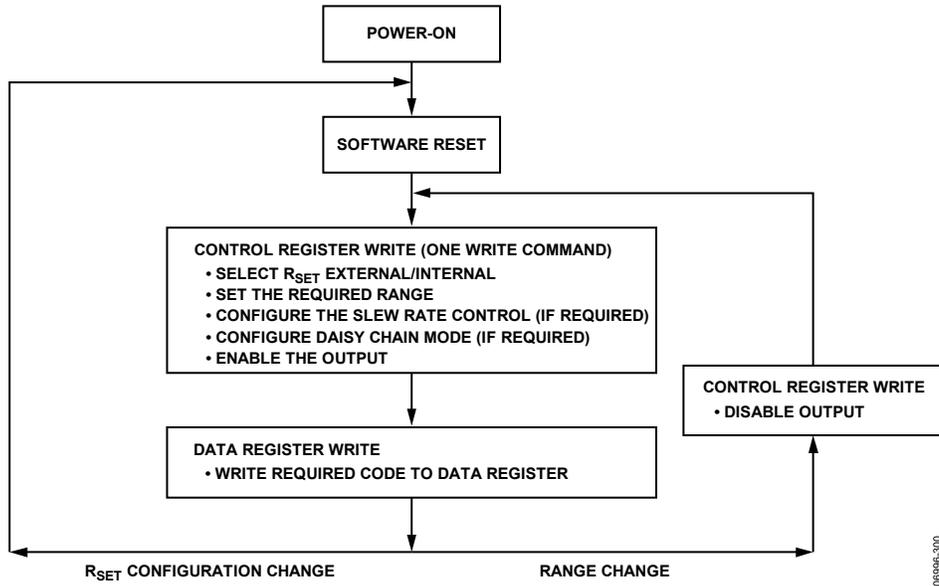

06956-300

Figure 69. Programming Sequence to Write/Enable the Output Correctly

**DATA REGISTER**

The data register is addressed by setting the address word of the input shift register to 0x01. The data to be written to the data register is entered in the D15 to D4 positions for the AD5412 and the D15 to D0 positions for the AD5422, as shown in Table 13 and Table 14.

**Table 13. Programming the AD5412 Data Register**

MSB												LSB			
D15	D14	D13	D12	D11	D10	D9	D8	D7	D6	D5	D4	D3	D2	D1	D0
12-bit data-word												X	X	X	X

**Table 14. Programming the AD5422 Data Register**

MSB															LSB
D15	D14	D13	D12	D11	D10	D9	D8	D7	D6	D5	D4	D3	D2	D1	D0
16-bit data-word															

**CONTROL REGISTER**

The control register is addressed by setting the address word of the input shift register to 0x55. The data to be written to the control register is entered in the D15 to D0 positions, as shown in Table 15. The control register functions are shown in Table 16.

**Table 15. Programming the Control Register**

MSB													LSB			
D15	D14	D13	D12	D11	D10	D9	D8	D7	D6	D5	D4	D3	D2	D1	D0	
CLRSEL	OVRNG	REXT	OUTEN	SR clock				SR step			SREN	DCEN	R2	R1	R0	

**Table 16. Control Register Functions**

Option	Description
CLRSEL	See Table 22 for a description of the CLRSEL operation.
OVRNG	Setting this bit increases the voltage output range by 10% (see the AD5412/AD5422 Features section).
REXT	Setting this bit selects the external current setting resistor (see the AD5412/AD5422 Features section). When using an external current setting resistor, it is recommended to only set REXT when also setting the OUTEN bit. Alternately, REXT can be set before the OUTEN bit is set, but the range (see Table 17) must be changed on the write in which the output is enabled. See Figure 69 for best practice.
OUTEN	Output enable. This bit must be set to enable the outputs. The range bits select which output is functional.
SR clock	Digital slew rate control (see the AD5412/AD5422 Features section).
SR step	Digital slew rate control (see the AD5412/AD5422 Features section).
SREN	Digital slew rate control enable.
DCEN	Daisy chain enable.
R2, R1, R0	Output range select (see Table 17).

**Table 17. Output Range Options**

R2	R1	R0	Output Range Selected
0	0	0	0 V to 5 V voltage range
0	0	1	0 V to 10 V voltage range
0	1	0	±5 V voltage range
0	1	1	±10 V voltage range
1	0	1	4 mA to 20 mA current range
1	1	0	0 mA to 20 mA current range
1	1	1	0 mA to 24 mA current range

**RESET REGISTER**

The reset register is addressed by setting the address word of the input shift register to 0x56. The data to be written to the reset register is entered in the D0 position as shown in Table 18. The reset register options are shown in Table 18 and Table 19.

**Table 18. Programming the Reset Register**

MSB														LSB	
D15	D14	D13	D12	D11	D10	D9	D8	D7	D6	D5	D4	D3	D2	D1	D0
Reserved														Reset	

**Table 19. Reset Register Functions**

Option	Description
Reset	Setting this bit performs a reset operation, restoring the <a href="#">AD5412/AD5422</a> to its power-on state.

**STATUS REGISTER**

The status register is a read-only register. The status register functionality is shown in Table 20 and Table 21.

**Table 20. Decoding the Status Register**

MSB														LSB		
D15	D14	D13	D12	D11	D10	D9	D8	D7	D6	D5	D4	D3	D2	D1	D0	
Reserved												I <sub>OUT</sub> fault	Slew active	Over temp		

**Table 21. Status Register Functions**

Option	Description
I <sub>OUT</sub> Fault	This bit is set if a fault is detected on the I <sub>OUT</sub> pin.
Slew Active	This bit is set while the output value is slewing (slew rate control enabled).
Over Temp	This bit is set if the <a href="#">AD5412/AD5422</a> core temperature exceeds ~150°C.

## AD5412/AD5422 FEATURES

### FAULT ALERT

The AD5412/AD5422 are equipped with a  $\overline{\text{FAULT}}$  pin, which is an open-drain output allowing several AD5412/AD5422 devices to be connected together to one pull-up resistor for global fault detection. The  $\overline{\text{FAULT}}$  pin is forced active by one of the following fault scenarios:

- The voltage at  $I_{\text{OUT}}$  attempts to rise above the compliance range, due to an open-loop circuit or insufficient power supply voltage. The  $I_{\text{OUT}}$  current is controlled by a PMOS transistor and internal amplifier, as shown in Figure 66. The internal circuitry that develops the fault output avoids using a comparator with window limits because this would require an actual output error before the  $\overline{\text{FAULT}}$  output becomes active. Instead, the signal is generated when the internal amplifier in the output stage has less than  $\sim 1$  V of remaining drive capability (when the gate of the output PMOS transistor nearly reaches ground). Thus, the  $\overline{\text{FAULT}}$  output activates slightly before the compliance limit is reached. Because the comparison is made within the feedback loop of the output amplifier, the output accuracy is maintained by its open-loop gain, and an output error does not occur before the  $\overline{\text{FAULT}}$  output becomes active.
- If the core temperature of the AD5412/AD5422 exceeds approximately 150°C.

The  $I_{\text{OUT}}$  fault and over temp bits of the status register are used in conjunction with the  $\overline{\text{FAULT}}$  pin to inform the user which one of the fault conditions caused the  $\overline{\text{FAULT}}$  pin to be asserted (see Table 20 and Table 21).

### VOLTAGE OUTPUT SHORT CIRCUIT PROTECTION

Under normal operation, the voltage output sinks/sources 10 mA. The maximum current that the voltage output delivers is  $\sim 20$  mA; this is the short-circuit current.

### VOLTAGE OUTPUT OVERRANGE

An overrange facility is provided on the voltage output. When enabled via the control register, the selected output range is overranged by, typically, 10%.

### VOLTAGE OUTPUT FORCE-SENSE

The  $+V_{\text{SENSE}}$  and  $-V_{\text{SENSE}}$  pins are provided to facilitate remote sensing of the load connected to the voltage output. If the load is connected at the end of a long or high impedance cable, sensing the voltage at the load allows the output amplifier to compensate and ensure that the correct voltage is applied across the load. This function is limited only by the available power supply headroom.

### ASYNCHRONOUS CLEAR (CLEAR)

The CLEAR pin is an active high clear that allows the voltage output to be cleared to either zero-scale code or midscale code, user selectable via the CLEAR SELECT pin, or the CLRSEL bit of the control register, as described in Table 22. (The clear select feature is a logical OR function of the CLEAR SELECT pin and the CLRSEL bit.) The current output clears to the bottom of its programmed range. It is necessary for CLEAR to be high for a minimum amount of time to complete the operation (see Figure 2). When the CLEAR signal is returned low, the output remains at the cleared value. The preclear value can be restored by pulsing the LATCH signal low without clocking any data. A new value cannot be programmed until the CLEAR pin is returned low.

Table 22. CLRSEL Options

CLRSEL	Output Value	
	Unipolar Output Range	Bipolar Output Range
0	0 V	0 V
1	Midscale	Zero scale

In addition to defining the output value for a clear operation, the CLRSEL bit and CLEAR SELECT pin also define the default output value. During selection of a new voltage range, the output value is as defined in Table 22. To avoid glitches on the output, it is recommended that, before changing voltage ranges, the user disable the output by setting the OUTEN bit of the control register to logic low. When OUTEN is set to logic high, the output goes to the default value as defined by CLRSEL and CLEAR SELECT.

### INTERNAL REFERENCE

The AD5412/AD5422 contain an integrated 5 V voltage reference with initial accuracy of  $\pm 5$  mV maximum and a temperature drift coefficient of  $\pm 10$  ppm/°C maximum. The reference voltage is buffered and externally available for use elsewhere within the system. See Figure 16 for a load regulation graph of the integrated reference.

### EXTERNAL CURRENT SETTING RESISTOR

$R_{\text{SET}}$  is an internal sense resistor as part of the voltage-to-current conversion circuitry (see Figure 66). The stability of the output current over temperature is dependent on the stability of the value of  $R_{\text{SET}}$ . As a method of improving the stability of the output current over temperature, an external precision 15 k $\Omega$  low drift resistor can be connected to the  $R_{\text{SET}}$  pin of the AD5412/AD5422 to be used instead of the internal resistor ( $R_{\text{SET}}$ ). The external resistor is selected via the control register (see Table 15).

**DIGITAL POWER SUPPLY**

By default, the DV<sub>CC</sub> pin accepts a power supply of 2.7 V to 5.5 V. Alternatively, via the DV<sub>CC</sub> SELECT pin, an internal 4.5 V power supply can be output on the DV<sub>CC</sub> pin for use as a digital power supply for other devices in the system or as a termination for pull-up resistors. This facility offers the advantage of not having to bring a digital supply across an isolation barrier. The internal power supply is enabled by leaving the DV<sub>CC</sub> SELECT pin unconnected. To disable the internal supply, tie DV<sub>CC</sub> SELECT to 0 V. DV<sub>CC</sub> is capable of supplying up to 5 mA of current (for a load regulation graph, see Figure 10).

**EXTERNAL BOOST FUNCTION**

The addition of an external boost transistor, as shown in Figure 70, reduces the power dissipated in the AD5412/AD5422 by reducing the current flowing in the on-chip output transistor (dividing it by the current gain of the external circuit). A discrete NPN transistor with a breakdown voltage, BV<sub>CEO</sub>, greater than 40 V can be used. The external boost capability has been developed for users who may wish to use the AD5412/AD5422 at the extremes of the supply voltage, load current, and temperature range. The boost transistor can also be used to reduce the amount of temperature-induced drift in the part. This minimizes the temperature-induced drift of the on-chip voltage reference, which improves on drift and linearity.

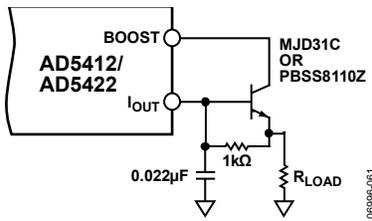

Figure 70. External Boost Configuration

**EXTERNAL COMPENSATION CAPACITOR**

The voltage output can ordinarily drive capacitive loads of up to 20 nF; if there is a requirement to drive greater capacitive loads, of up to 1 µF, an external compensation capacitor can be connected between the C<sub>COMP</sub> and V<sub>OUT</sub> pins. The addition of the capacitor keeps the output voltage stable but also reduces the bandwidth and increases the settling time of the voltage output.

**HART COMMUNICATION**

The AD5412/AD5422 (LFCSP version only) contain a CAP2 pin, into which a HART signal can be coupled. The HART signal appears on the current output if the output is enabled. To achieve a 1 mA peak-to-peak current, the signal amplitude at the CAP2 pin must be 48 mV peak-to-peak. Assuming that the modem output amplitude is 500 mV peak-to-peak, its output must be attenuated by 500/48 = 10.42. If this voltage is used, the current output should meet the HART amplitude specifications. Figure 71 shows the recommended circuit for attenuating and coupling in the HART signal.

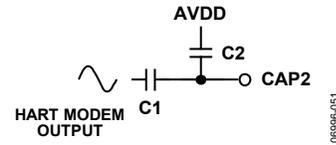

Figure 71. Coupling HART Signal

In determining the absolute values of the capacitors, ensure that the FSK output from the modem is passed undistorted. Thus, the bandwidth presented to the modem output signal must pass 1200 Hz and 2200 Hz frequencies. The recommended values are C1 = 2.2 nF and C2 = 22 nF. Digitally controlling the slew rate of the output is necessary to meet the analog rate of change requirements for HART.

**DIGITAL SLEW RATE CONTROL**

The slew rate control feature of the AD5412/AD5422 allows the user to control the rate at which the output voltage or current changes. With the slew rate control feature disabled, the output changes at a rate limited by the output drive circuitry and the attached load. See Figure 64 for current output step and Figure 38 for voltage output step. To reduce the slew rate, enable the slew rate control feature. With the feature enabled via the SREN bit of the control register (see Table 15), the output, instead of slewing directly between two values, steps digitally at a rate defined by two parameters accessible via the control register, as shown in Table 15. The parameters are set by the SR clock and SR step bits. SR clock defines the rate at which the digital slew is updated; SR step defines by how much the output value changes at each update. Both parameters together define the rate of change of the output voltage or current. Table 23 and Table 24 outline the range of values for both the SR clock and SR step parameters. Figure 72 shows the output current changing for ramp times of 10 ms, 50 ms, and 100 ms.

Table 23. Slew Rate Step Size Options

SR Step	AD5412 Step Size (LSB)	AD5422 Step Size (LSB)
000	1/16	1
001	1/8	2
010	1/4	4
011	1/2	8
100	1	16
101	2	32
110	4	64
111	8	128

Table 24. Slew Rate Update Clock Options

SR Clock	Update Clock Frequency (Hz)
0000	257,730
0001	198,410
0010	152,440
0011	131,580
0100	115,740
0101	69,440
0110	37,590
0111	25,770
1000	20,160
1001	16,030
1010	10,290
1011	8280
1100	6900
1101	5530
1110	4240
1111	3300

The time it takes for the output to slew over a given output range can be expressed as follows:

$$Slew\ Time = \frac{Output\ Change}{Step\ Size \times Update\ Clock\ Frequency \times LSB\ Size} \quad (1)$$

where:

Slew Time is expressed in seconds.

Output Change is expressed in amps for I<sub>OUT</sub> or volts for V<sub>OUT</sub>.

When the slew rate control feature is enabled, all output changes change at the programmed slew rate; if the CLEAR pin is asserted, the output slews to the zero-scale value at the programmed slew rate. The output can be halted at its current value with a write to the control register. To avoid halting the output slew, the slew active bit (see Table 20) can be read to check that the slew has completed before writing to any of the AD5410/AD5420 registers. The update clock frequency for any given value is the same for all output ranges. The step size, however, varies across output ranges for a given value of step size because the LSB size is different for each output range. Table 25 shows the range of programmable slew times for a full-scale change on any of the output ranges. The values in Table 25 were obtained using Equation 1.

The digital slew rate control feature results in a staircase formation on the current output, as shown in Figure 76. This figure also shows how the staircase can be removed by connecting capacitors to the CAP1 and CAP2 pins, as described in the I<sub>OUT</sub> Filtering Capacitors (LFCSP Package) section.

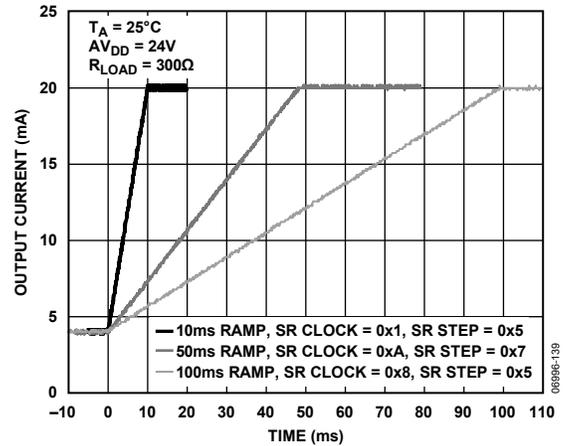

Figure 72. Output Current Slew Rate Under Control of the Digital Slew Rate Control Feature

### I<sub>OUT</sub> FILTERING CAPACITORS (LFCSP PACKAGE)

Capacitors can be placed between CAP1 and AV<sub>DD</sub>, and CAP2 and AV<sub>DD</sub>, as shown in Figure 73.

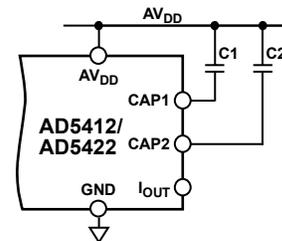

Figure 73. I<sub>OUT</sub> Filtering Capacitors

The CAP1 and CAP2 pins are available only on the LFCSP package. The capacitors form a filter on the current output circuitry, as shown in Figure 74, reducing the bandwidth and the slew rate of the output current. Figure 75 shows the effect the capacitors have on the slew rate of the output current. To achieve significant reductions in the rate of change, very large capacitor values are required, which may not be suitable in some applications. In this case, the digital slew rate control feature can be used. The capacitors can be used in conjunction with the digital slew rate control feature as a means of smoothing out the steps caused by the digital code increments, as shown in Figure 76.

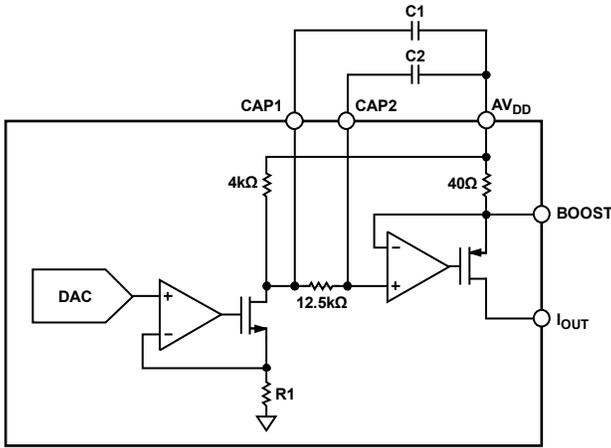

Figure 74.  $I_{OUT}$  Filter Circuitry

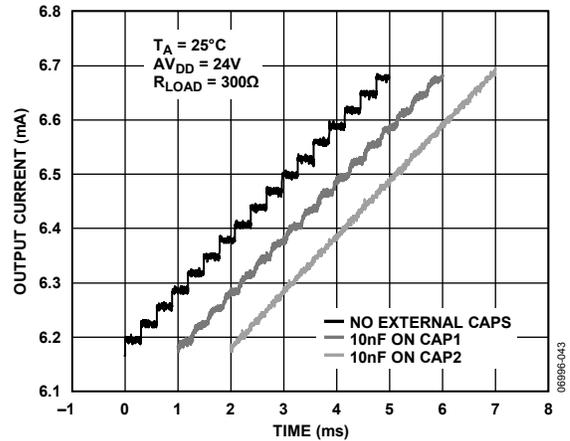

Figure 76. Smoothing Out the Steps Caused by the Digital Slew Rate Control Feature

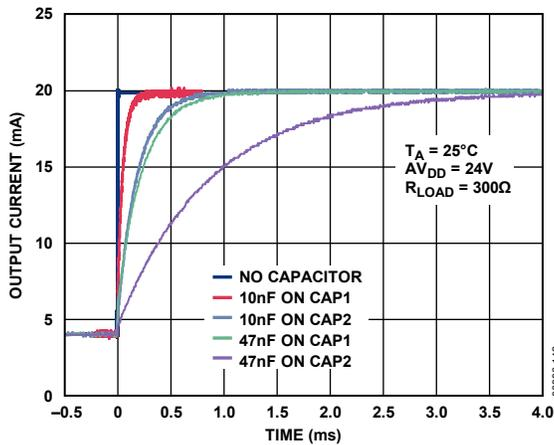

Figure 75. Slow Controlled 4 mA to 20 mA Output Current Step Using External Capacitors on the CAP1 and CAP2 Pins

Table 25. Programmable Slew Time Values in Seconds for a Full-Scale Change on Any Output Range

Update Clock Frequency (Hz)	Step Size (LSB)							
	1	2	4	8	16	32	64	128
257,730	0.25	0.13	0.06	0.03	0.016	0.008	0.004	0.0020
198,410	0.33	0.17	0.08	0.04	0.021	0.010	0.005	0.0026
152,440	0.43	0.21	0.11	0.05	0.027	0.013	0.007	0.0034
131,580	0.50	0.25	0.12	0.06	0.031	0.016	0.008	0.0039
115,740	0.57	0.28	0.14	0.07	0.035	0.018	0.009	0.0044
69,440	0.9	0.47	0.24	0.12	0.06	0.03	0.015	0.007
37,590	1.7	0.87	0.44	0.22	0.11	0.05	0.03	0.014
25,770	2.5	1.3	0.64	0.32	0.16	0.08	0.04	0.020
20,160	3.3	1.6	0.81	0.41	0.20	0.10	0.05	0.025
16,030	4.1	2.0	1.0	0.51	0.26	0.13	0.06	0.03
10,290	6.4	3.2	1.6	0.80	0.40	0.20	0.10	0.05
8280	7.9	4.0	2.0	1.0	0.49	0.25	0.12	0.06
6900	9.5	4.8	2.4	1.2	0.59	0.30	0.15	0.07
5530	12	5.9	3.0	1.5	0.74	0.37	0.19	0.09
4240	15	7.7	3.9	1.9	0.97	0.48	0.24	0.12
3300	20	9.9	5.0	2.5	1.24	0.62	0.31	0.16

## APPLICATIONS INFORMATION

### VOLTAGE AND CURRENT OUTPUT RANGES ON THE SAME TERMINAL

The current and voltage output pins can be connected together. A buffer amplifier is required, however, to prevent a current leakage path through an internal 30 kΩ resistor on the +V<sub>SENSE</sub> pin when the device is in current output mode. In current mode, the V<sub>OUT</sub> pin is high impedance; whereas in voltage output mode, the I<sub>OUT</sub> pin is high impedance and does not affect the voltage output. It is important that the external R<sub>SET</sub> be used in this configuration, as depicted in Figure 77.

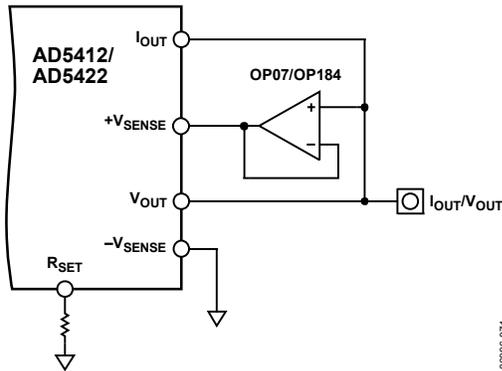

Figure 77. I<sub>OUT</sub> and V<sub>OUT</sub> Connected Together

### DRIVING INDUCTIVE LOADS

When driving inductive or poorly defined loads, connect a 0.01 μF capacitor between I<sub>OUT</sub> and GND. This ensures stability with loads above 50 mH. There is no maximum capacitance limit. The capacitive component of the load may cause slower settling. The digital slew rate control feature may also prove useful in this situation.

### TRANSIENT VOLTAGE PROTECTION

The AD5412/AD5422 contain ESD protection diodes that prevent damage from normal handling. The industrial control environment can, however, subject I/O circuits to much higher transients. To protect the AD5412/AD5422 from excessively high voltage transients, external power diodes and a surge current limiting resistor are required, as shown in Figure 78. The constraint on the resistor value is that, during normal operation, the output level at I<sub>OUT</sub> must remain within its voltage compliance limit of AV<sub>DD</sub> – 2.5 V, and the two protection diodes and resistor must have appropriate power ratings. Further protection can be provided with transient voltage suppressors or transorbs; these are available as both unidirectional suppressors (protect against positive high voltage transients) and bidirectional suppressors (protect against both positive and negative high voltage transients) and are available in a wide range of standoff and breakdown voltage ratings. It is recommended that all field connected nodes be protected.

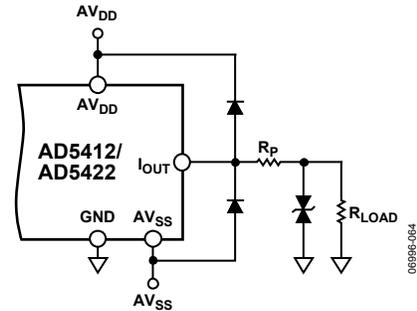
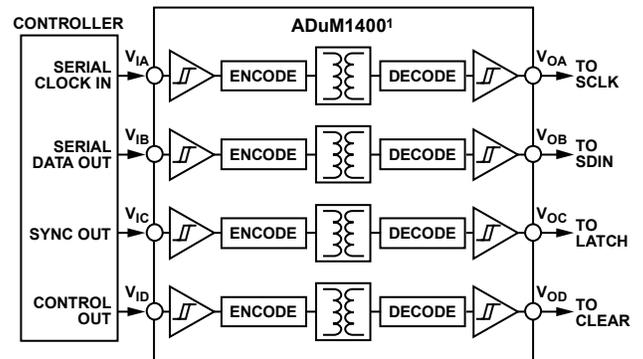

Figure 78. Output Transient Voltage Protection

### GALVANICALLY ISOLATED INTERFACE

In many process control applications, it is necessary to provide an isolation barrier between the controller and the unit being controlled to protect and isolate the controlling circuitry from any hazardous common-mode voltages that may occur. The iCoupler® products from Analog Devices, Inc., provide voltage isolation in excess of 2.5 kV. The serial loading structure of the AD5412/AD5422 makes the parts ideal for isolated interfaces because the number of interface lines is kept to a minimum. Figure 79 shows a 4-channel isolated interface to the AD5412/AD5422 using an ADuM1400. For further information, visit [www.analog.com/isolators](http://www.analog.com/isolators).



<sup>1</sup>ADDITIONAL PINS OMITTED FOR CLARITY.

Figure 79. Isolated Interface

### MICROPROCESSOR INTERFACING

Microprocessor interfacing to the AD5412/AD5422 is via a serial bus that uses a protocol compatible with microcontrollers and DSP processors. The communications channel is a 3-wire minimum interface consisting of a clock signal, a data signal, and a latch signal. The AD5412/AD5422 require a 24-bit data-word with data valid on the rising edge of SCLK.

For all interfaces, the DAC output update is initiated on the rising edge of LATCH. The contents of the registers can be read using the readback function.

## LAYOUT GUIDELINES

In any circuit where accuracy is important, careful consideration of the power supply and ground return layout helps to ensure the rated performance. Design the printed circuit board (PCB) on which the AD5412/AD5422 is mounted so that the analog and digital sections are separated and confined to certain areas of the board. If the AD5412/AD5422 is in a system where multiple devices require an analog ground-to-digital ground connection, make the connection at one point only. Establish the star ground point as close as possible to the device.

The AD5412/AD5422 should have ample supply bypassing of 10  $\mu\text{F}$  in parallel with 0.1  $\mu\text{F}$  on each supply located as close to the package as possible, ideally right up against the device. The 10  $\mu\text{F}$  capacitors are the tantalum bead type. The 0.1  $\mu\text{F}$  capacitor should have low effective series resistance (ESR) and low effective series inductance (ESI), such as the common ceramic types, which provide a low impedance path to ground at high frequencies to handle transient currents due to internal logic switching.

The power supply lines of the AD5412/AD5422 should use as large a trace as possible to provide low impedance paths and reduce the effects of glitches on the power supply line. Fast switching signals such as clocks should be shielded with a digital ground to avoid radiating noise to other parts of the board. Never run these near the reference inputs. A ground line routed between the SDIN and SCLK lines helps reduce crosstalk between them (this is not required on a multilayer board that has a separate ground plane, but separating the lines helps). It is essential to minimize noise on the REFIN line because it couples through to the DAC output.

Avoid crossover of digital and analog signals. Traces on opposite sides of the PCB should run at right angles to each other. This reduces the effects of feed through the board. A microstrip technique is by far the best but not always possible with a double-sided board. In this technique, the component side of the board is dedicated to the ground plane, and signal traces are placed on the solder side.

## THERMAL AND SUPPLY CONSIDERATIONS

The AD5412/AD5422 are designed to operate at a maximum junction temperature of 125°C. It is important that the devices not be operated under conditions that cause the junction temperature to exceed this value. Excessive junction temperature can occur if the AD5412/AD5422 are operated from the

maximum  $AV_{DD}$  while driving the maximum current (24 mA) directly to ground. In this case, control the ambient temperature or reduce  $AV_{DD}$ . The conditions depend on the device package.

At the ambient temperature of 85°C, the 24-lead TSSOP package can dissipate 1.14 mW, and the 40-lead LFCSP package can dissipate 1.21 W.

To ensure that the junction temperature does not exceed 125°C while driving the maximum current of 24 mA directly into ground (also adding an on-chip current of 3 mA), reduce  $AV_{DD}$  from the maximum rating to ensure that the package is not required to dissipate more power than previously stated (see Table 26, Figure 80, and Figure 81).

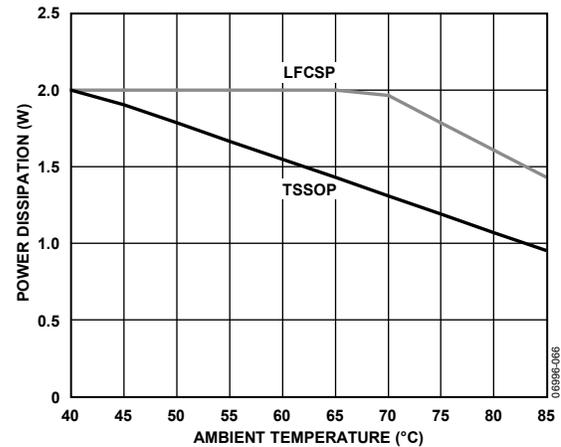

Figure 80. Maximum Power Dissipation vs. Ambient Temperature

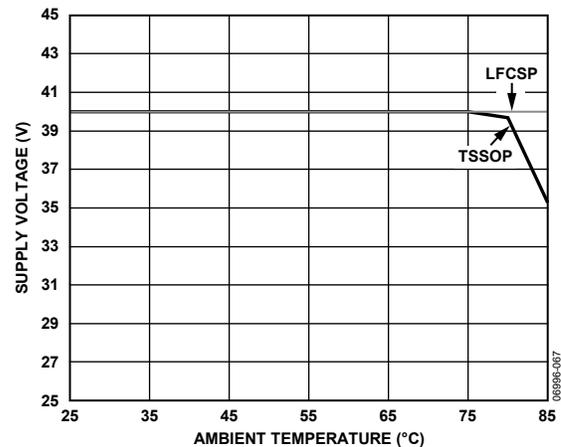

Figure 81. Maximum Supply Voltage vs. Ambient Temperature

Table 26. Thermal and Supply Considerations for Each Package

Considerations	TSSOP	LFCSP
Maximum Allowed Power Dissipation When Operating at an Ambient Temperature of 85°C	$\frac{T_j \max - T_A}{\theta_{JA}} = \frac{125 - 85}{35} = 1.14 \text{ W}$	$\frac{T_j \max - T_A}{\theta_{JA}} = \frac{125 - 85}{33} = 1.21 \text{ W}$
Maximum Allowed Ambient Temperature When Operating from a Supply of 40 V and Driving 24 mA Directly to Ground	$T_j \max - P_D \times \theta_{JA} = 125 - (40 \times 0.028) \times 35 = 86^\circ\text{C}$	$T_j \max - P_D \times \theta_{JA} = 125 - (40 \times 0.028) \times 33 = 88^\circ\text{C}$
Maximum Allowed Supply Voltage When Operating at an Ambient Temperature of 85°C and Driving 24 mA Directly to Ground	$\frac{T_j \max - T_A}{AI_{DD} \times \theta_{JA}} = \frac{125 - 85}{0.028 \times 35} = 40 \text{ V}$	$\frac{T_j \max - T_A}{AI_{DD} \times \theta_{JA}} = \frac{125 - 85}{0.028 \times 33} = 43 \text{ V}$

## INDUSTRIAL ANALOG OUTPUT MODULE

Many industrial control applications have requirements for accurately controlled current and voltage output signals. The [AD5412/AD5422](#) are ideal for such applications. Figure 83 shows the [AD5412/AD5422](#) in a circuit design for an output module, specifically for use in an industrial control application. The design provides for a current or voltage output. The module is powered from a field supply of 24 V. This supplies  $AV_{DD}$  directly. An inverting buck regulator generates the negative supply for  $AV_{SS}$ . For transient overvoltage protection, transient voltage suppressors (TVS) are placed on all field accessible connections. A 24 V TVS is placed on each  $I_{OUT}$ ,  $V_{OUT}$ ,  $+V_{SENSE}$ , and  $-V_{SENSE}$  connection, and a 36 V TVS is placed on the field supply input. For added protection, clamping diodes are connected from the  $I_{OUT}$ ,  $V_{OUT}$ ,  $+V_{SENSE}$ , and  $-V_{SENSE}$  pins to the  $AV_{DD}$  and  $AV_{SS}$  power supply pins. If remote voltage load sensing is not required, the  $+V_{SENSE}$  pin can be directly connected to the  $V_{OUT}$  pin and the  $-V_{SENSE}$  pin can be connected to GND.

Isolation between the [AD5412/AD5422](#) and the backplane circuitry is provided with [ADuM1400](#) and [ADuM1200](#) iCoupler digital isolators; further information on iCoupler products is available at [www.analog.com/isolators](http://www.analog.com/isolators). The internally generated digital power supply of the [AD5412/AD5422](#) powers the field side of the digital isolators, removing the need to generate a digital power supply on the field side of the isolation barrier. The [AD5412/AD5422](#) digital supply output supplies up to 5 mA, which is more than enough to supply the 2.8 mA requirements of the [ADuM1400](#) and [ADuM1200](#) operating at a logic signal frequency of up to 1 MHz. To reduce the number of isolators required, nonessential signals such as CLEAR can be connected to GND. FAULT and SDO can be left unconnected, reducing the isolation requirements to just three signals. See [Circuit Note CN0321](#) for an example of a built and tested circuit of a fully isolated, single channel voltage and 4 mA to 20 mA output with HART.

## INDUSTRIAL HART CAPABLE ANALOG OUTPUT APPLICATION

Many industrial control applications have requirements for accurately controlled current output signals, and the [AD5412/AD5422](#) are ideal for such applications. Figure 82 shows the [AD5412/AD5422](#) in a circuit design for a HART-enabled output module, specifically for use in an industrial control application in

which both the voltage output and current output are available—one at a time—on one pin, thus reducing the number of screw connections required. There is no conflict with tying the two output pins together because only the voltage output or the current output can be enabled at any one time. For further information on this circuit, see [Circuit Note CN0278, Complete 4 mA to 20 mA HART Solution with Additional Voltage Output Capability](#).

The design provides for a HART-enabled current output, with the HART capability provided by the [AD5700/AD5700-1](#) HART modem, the industry's lowest power and smallest footprint HART-compliant IC modem. For additional space-savings, the [AD5700-1](#) offers a 0.5% precision internal oscillator. The HART\_OUT signal from the [AD5700](#) is attenuated and ac-coupled into the RSET pin of the [AD5412/AD5422](#). Because the RSET pin is used to couple the HART signal into the [AD5412/AD5422](#), either the TSSOP or LFCSP package option can be used for this configuration. It should be noted however, that since the TSSOP package does not have a CAP1 pin, C1 (see Figure 82) cannot be inserted in this case. While the TSSOP equivalent circuit (as in Figure 82 but without C1 in place) still passes the HART Communication Foundation physical layer specs, the results with C1 in place are superior to those without C1 in place. Further information on an alternative configuration, whereby the HART signal is coupled into the CAP2 pin can be found in [Application Note AN-1065](#). This is based on the [AD5410/AD5420](#) but can also be applied to the [AD5412/AD5422](#). Use of either configuration results in the [AD5700](#) HART modem output modulating the 4 mA to 20 mA analog current without affecting the dc level of the current. This circuit adheres to the HART physical layer specifications as defined by the HART Communication Foundation.

The module is powered from a field supply of  $\pm 10.8 \text{ V}$  to  $\pm 26.4 \text{ V}$ . This supplies  $AV_{DD}/AV_{SS}$  directly. For transient overvoltage protection, transient voltage suppressors (TVS) are placed on both the  $I_{OUT}$  and field supply connections. A 24 V TVS is placed on the  $I_{OUT}$  connection, and a 36 V TVS is placed on the field supply input(s). For added protection, clamping diodes are connected from the  $I_{OUT}$  pin to the  $AV_{DD}$  and GND power supply pins. A 10 k $\Omega$  current limiting resistor is also placed in series with the positive terminal of the  $+V_{SENSE}$  buffer input. This is to limit the current to an acceptable level during a transient event.



OUTLINE DIMENSIONS

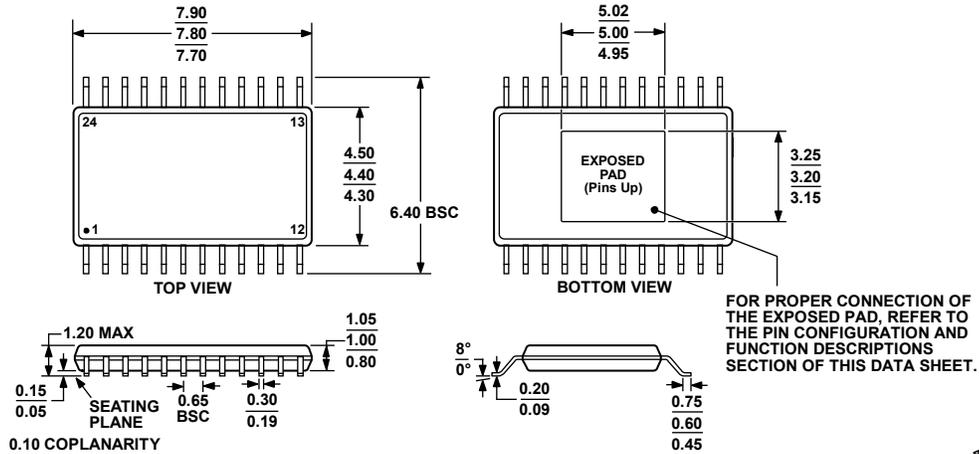

COMPLIANT TO JEDEC STANDARDS MO-153-ADT

Figure 84. 24-Lead Thin Shrink Small Outline Package, Exposed Pad [TSSOP\_EP] (RE-24)  
Dimensions shown in millimeters

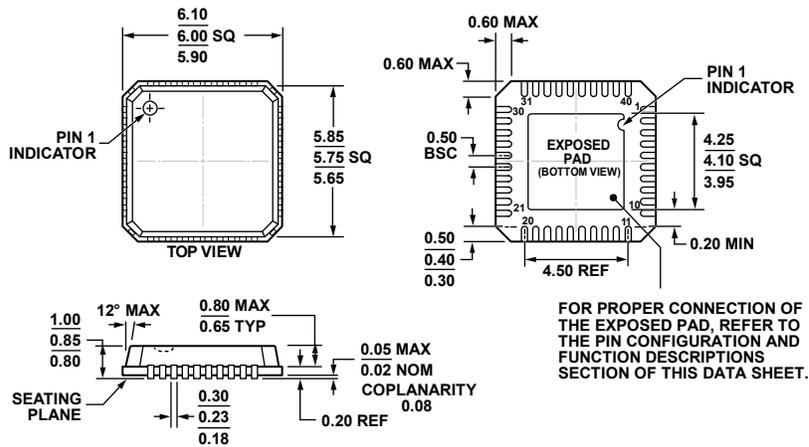

COMPLIANT TO JEDEC STANDARDS MO-220-VJJD-2

Figure 85. 40-Lead Lead Frame Chip Scale Package [LFCSP] 6 mm x 6 mm Body and 0.85 mm Package Height (CP-40-1)  
Dimensions shown in millimeters

081708-A

06-01-2012-D

## ORDERING GUIDE

Model <sup>1</sup>	Resolution (Bits)	I <sub>OUT TUE</sub> (% FSR max)	V <sub>OUT TUE</sub> (% FSR max)	Temperature Range	Package Description	Package Option
AD5412AREZ	12	0.5	0.3	−40°C to +105°C	24-Lead TSSOP_EP	RE-24
AD5412AREZ-REEL7	12	0.5	0.3	−40°C to +105°C	24-Lead TSSOP_EP	RE-24
AD5412ACPZ-REEL	12	0.5	0.3	−40°C to +105°C	40-Lead LFCSP	CP-40-1
AD5412ACPZ-REEL7	12	0.5	0.3	−40°C to +105°C	40-Lead LFCSP	CP-40-1
AD5422AREZ	16	0.5	0.3	−40°C to +105°C	24-Lead TSSOP_EP	RE-24
AD5422AREZ-REEL	16	0.5	0.3	−40°C to +105°C	24-Lead TSSOP_EP	RE-24
AD5422BREZ	16	0.3	0.1	−40°C to +105°C	24-Lead TSSOP_EP	RE-24
AD5422BREZ-REEL	16	0.3	0.1	−40°C to +105°C	24-Lead TSSOP_EP	RE-24
AD5422ACPZ-REEL	16	0.5	0.3	−40°C to +105°C	40-Lead LFCSP	CP-40-1
AD5422ACPZ-REEL7	16	0.5	0.3	−40°C to +105°C	40-Lead LFCSP	CP-40-1
AD5422BCPZ-REEL	16	0.3	0.1	−40°C to +105°C	40-Lead LFCSP	CP-40-1
AD5422BCPZ-REEL7	16	0.3	0.1	−40°C to +105°C	40-Lead LFCSP	CP-40-1
EVAL-AD5422EBZ					AD5422 Evaluation Board	
EVAL-AD5422LFEBZ					AD5422 LFCSP Evaluation Board	

<sup>1</sup> Z = RoHS Compliant Part.

# Mouser Electronics

Authorized Distributor

Click to View Pricing, Inventory, Delivery & Lifecycle Information:

## [Analog Devices Inc.:](#)

[EVAL-AD5422EBZ](#) [EVAL-AD5422LFEBZ](#) [AD5412ACPZ-REEL](#) [AD5412AREZ-REEL7](#) [AD5412ACPZ-REEL7](#)  
[AD5422ACPZ-REEL7](#) [AD5412AREZ](#) [AD5422BCPZ-REEL7](#) [AD5422AREZ](#) [AD5422BREZ-REEL](#) [AD5422ACPZ-REEL](#)  
[AD5422AREZ-REEL](#) [AD5422BCPZ-REEL](#) [AD5422BREZ](#)